

SMD Power Inductor CDRH5D16F/LD

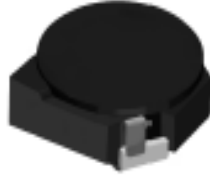

Description

- Ferrite drum core construction.
- Magnetically shielded.
- L × W × H: 5.5 × 5.5 × 1.8 mm Max.
- Product weight: 163mg(Ref.)
- Moisture Sensitivity Level: 1
- RoHS compliance.

Environmental Data

- Operating temperature range: -40°C ~ +105°C (including coil's self temperature rise)
- Storage temperature range: -40°C ~ +105°C
- Solder reflow temperature: 260 °C peak.

Packaging

- Carrier tape and reel packaging
- 7.0" diameter reel
- 1000pcs per reel

Applications

- Ideally used in Game Machine, Notebook PC, PDA, DSC/DVC, etc. as DC-DC converter inductors.

Dimension - [mm]

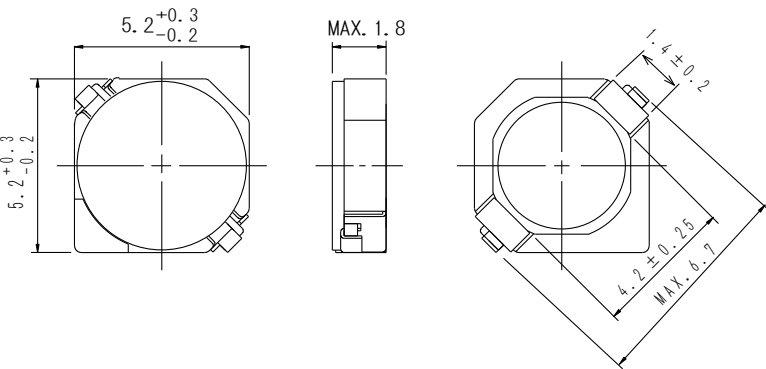

Land pattern and Schematics - [mm]

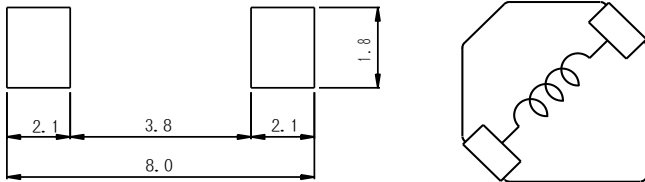

Electrical Characteristics

Part Name	Stamp	Inductance (μH) [within] ※1	D.C.R. (mΩ) Max. (Typ.) (20°C)	Saturation Current (A) ※2	Temperature Rise Current (A) ※3
CDRH5D16F/LDNP-2R2NC	2R2	2.2±25%	27.0(22.5)	1.80	3.80
CDRH5D16F/LDNP-2R9NC	2R9	2.9±25%	32.0(26.7)	1.60	3.60
CDRH5D16F/LDNP-4R7NC	4R7	4.7±25%	37.0(31.0)	1.20	2.90
CDRH5D16F/LDNP-6R8NC	6R8	6.8±25%	50.0(42.0)	1.05	2.40
CDRH5D16F/LDNP-100NC	100	10±25%	78.6(65.5)	0.92	1.90
CDRH5D16F/LDNP-150NC	150	15±25%	110.0(92.0)	0.70	1.50
CDRH5D16F/LDNP-220NC	220	22±25%	168.0(140.0)	0.61	1.20
CDRH5D16F/LDNP-330NC	330	33±25%	267.0(223.0)	0.50	0.90
CDRH5D16F/LDNP-470NC	470	47±25%	363.0(303.0)	0.40	0.82

※1. Inductance measuring condition: at 100kHz.

※2. Saturation current: The value of D.C. current when the inductance decreases to 65% of it's nominal value.

※3. Temperature rise current: The value of D.C. current when the temperature rise is Δt=40°C(Ta=20°C).

SMD Power Inductor CDRH5D16F/LD



Saturation Current & Temperature Rise Graph

— L (20°C) — L (105°C) — ΔT

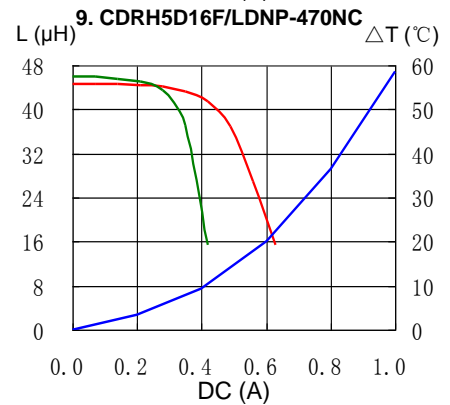
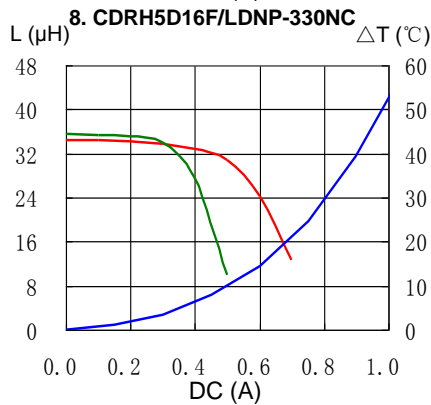
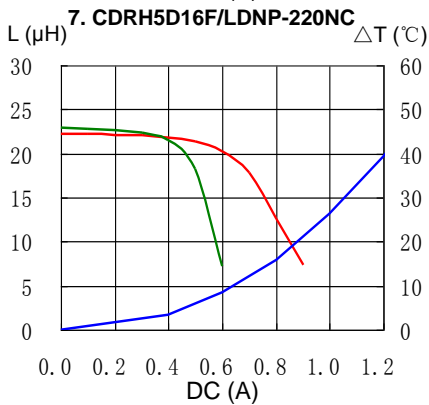
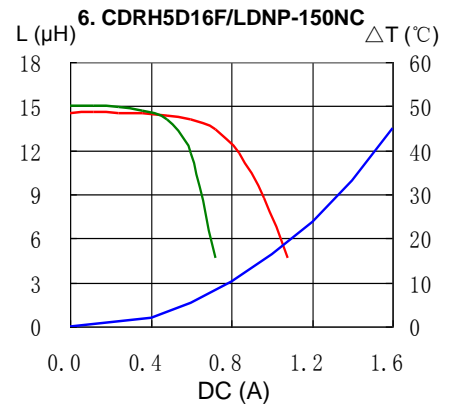
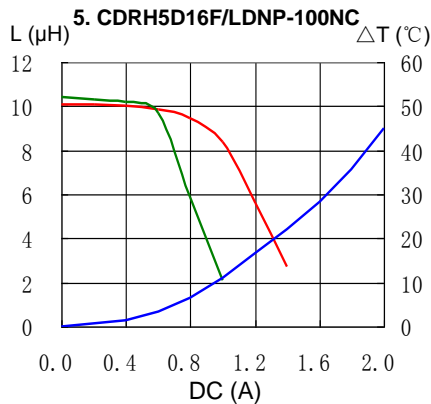
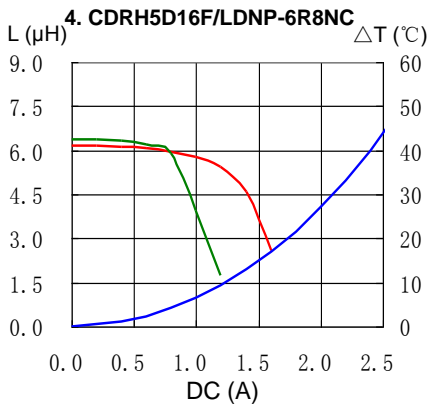
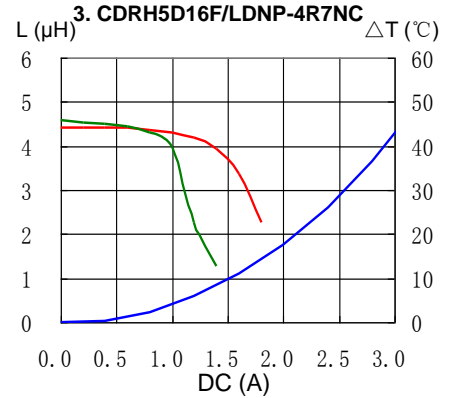
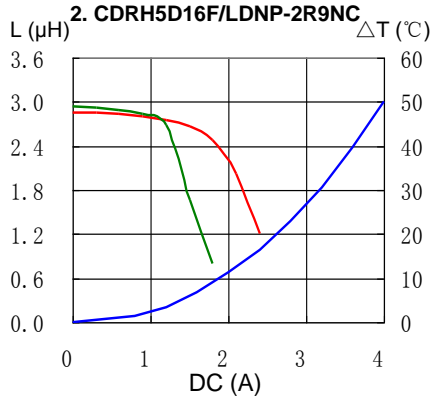
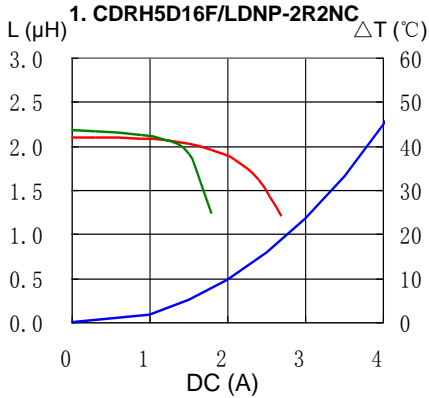

SMD Power Inductor CDRH5D16F/LD



Solder Reflow Condition

Heat Endurance

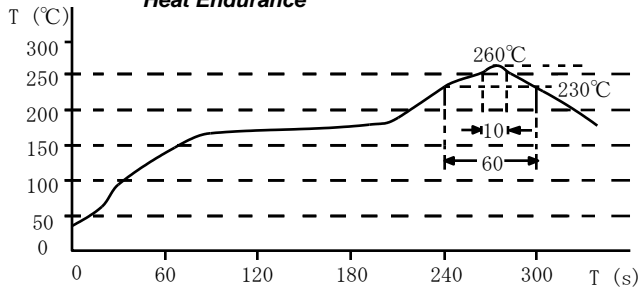

Temperature Chart

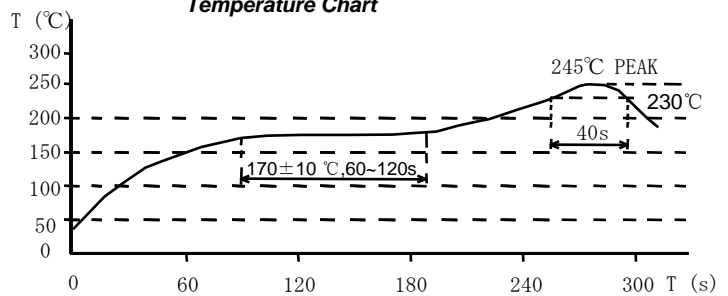

Please refer to the sales offices on our website - <http://www.sumida.com>

Hong Kong

Tel.+852-2880-6781
FAX.+852-2565-9600
sales@hk.sumida.com

Saitama(Japan)

Tel.+81-48-691-7300
FAX.+81-48-691-7340
sales@jp.sumida.com

Chicago

Tel.+1-847-545-6700
FAX. +1-847-545-6720
sales@us.sumida.com

Shanghai

Tel.+86-21-5836-3299
FAX.+86-21-5836-3266
shanghai.sales@cn.sumida.com

Seoul

Tel.+82-2-6237-0777
FAX.+82-2-6237-0778
sales@kr.sumida.com

Obernzell

Tel.+49-8591-937-0
FAX. +49-8591-937-103
contact@eu.sumida.com

Shenzhen

Tel.+86-755-8291-0228
FAX.+86-755-8291-0338
shenzhen.sales@cn.sumida.com

Singapore

Tel.+65-6296-3388
FAX.+65-6841-4426
sales@sg.sumida.com

Neumarkt

Tel.+49-9181-4509-110
FAX. +49-9181-4509-310
infocomp@eu.sumida.com

Taipei

Tel.+886-2-8751-2737
FAX.+886-2-8751-2738
sales@tw.sumida.com

San Jose

Tel.+1-408-321-9660
FAX.+1-408-321-9308
sales@us.sumida.com