

SMD Power Inductor CEP12D38

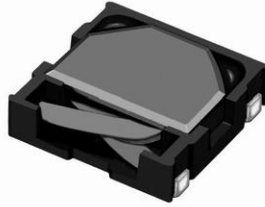

Dimension - [mm]

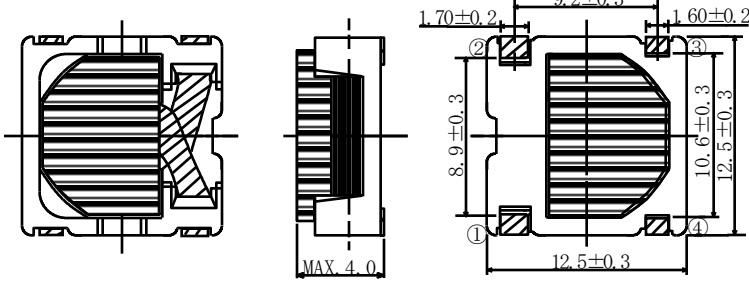

Land pattern and Schematics - [mm]

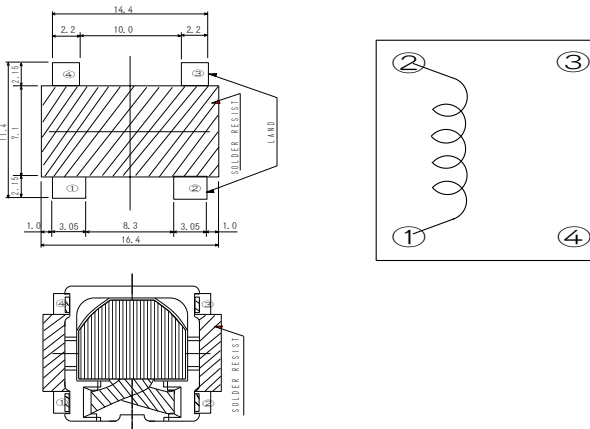

Description

- Ferrite core construction.
- Magnetically shielded.
- L × W × H: 12.8 × 12.8 × 4.0 mm Max.
- Product weight: 1.83g(Ref.)
- Moisture Sensitivity Level: 1
- RoHS compliance.

Environmental Data

- Operating temperature range: -40°C ~ +125°C (including coil's self temperature rise)
- Storage temperature range: -40°C ~ +125°C
- Solder reflow temperature: 260 °C peak.

Packaging

- Carrier tape and reel packaging
- 13.0" diameter reel
- 1000pcs per reel

Applications

- Ideally used in Notebook PC, CPU power supply.

SMD Power Inductor CEP12D38



Electrical Characteristics - 1

PART NO.	STAMP	INDUCTANCE [WITHIN] ※1	D.C.R. (mΩ) [MAX.] (Typ.) (at 20°C)	SATURATION CURRENT (A) ※2		TEMPERATURE RISE CURRENT (A) ※3
				(at 20°C)	(at100°C)	
CEP12D38NP-0R6MC-H	0R6MH	0.6μH ±20%	6.0(5.0)	24.4	20.0	11.5
CEP12D38NP-1R1MC-H	1R1MH	1.1μH ±20%	7.2(6.0)	18.1	14.6	10.0
CEP12D38NP-1R8MC-H	1R8MH	1.8μH ±20%	8.6(7.1)	13.9	11.5	9.5
CEP12D38NP-2R6MC-H	2R6MH	2.6μH ±20 %	12.1(10.1)	12.2	9.9	8.0

Electrical Characteristics - 2

PART NO.	STAMP	INDUCTANCE [WITHIN] ※1	D.C.R. (mΩ) [MAX.] (Typ.) (at 20°C)	SATURATION CURRENT (A) ※2		TEMPERATURE RISE CURRENT (A) ※3
				(at 20°C)	(at100°C)	
CEP12D38NP-1R0MC	1R0M	1.0μH ±20%	6.0(5.0)	14.8	12.2	11.5
CEP12D38NP-1R8MC	1R8M	1.8μH ±20%	7.2(6.0)	11.0	9.0	10.0
CEP12D38NP-2R8MC	2R8M	2.8μH ±20%	8.6(7.1)	8.8	7.4	9.5
CEP12D38NP-4R0MC	4R0M	4.0μH ±20%	12.1(10.1)	7.2	6.2	8.0

※1. Measuring condition: at 100kHz.

※2. Saturation current: The value of D.C. current when the inductance decreases to 75% of it's nominal value.

※3. Temperature rise current: The value of D.C. current when the temperature rise is $\Delta t=40^{\circ}\text{C}$ ($T_a=20^{\circ}\text{C}$).

SMD Power Inductor CEP12D38



Saturation Current & Temperature Rise Graph

— L (20°C) — L (100°C) — ΔT

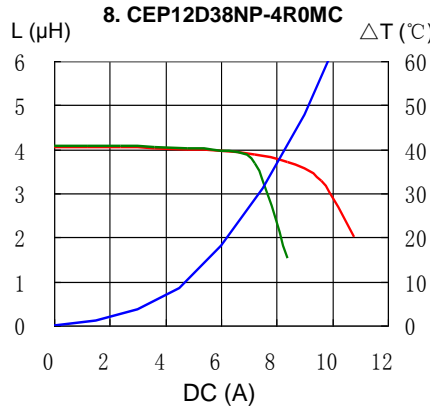
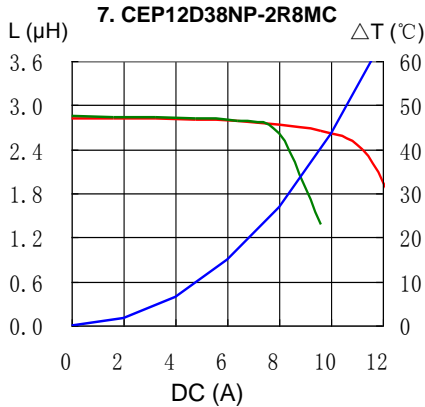
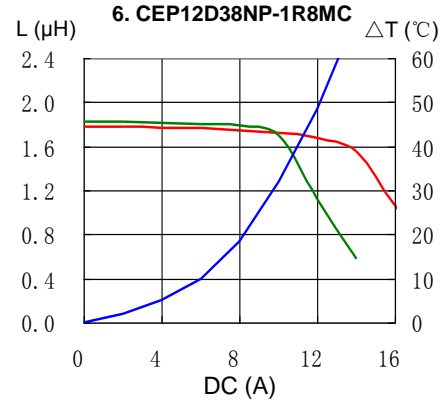
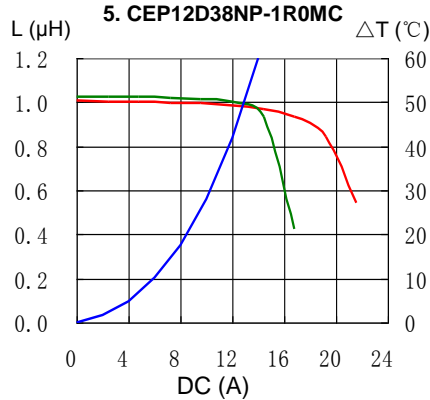
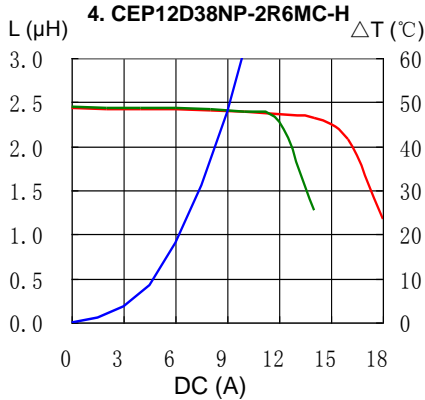
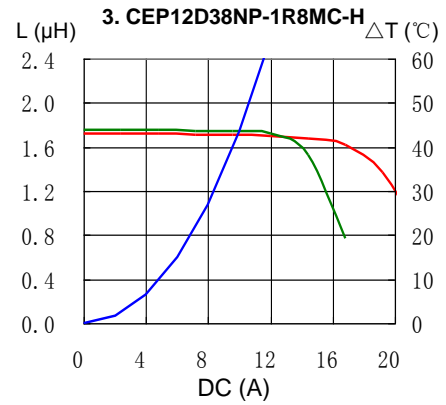
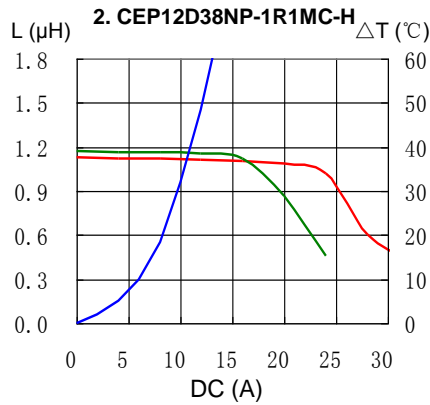
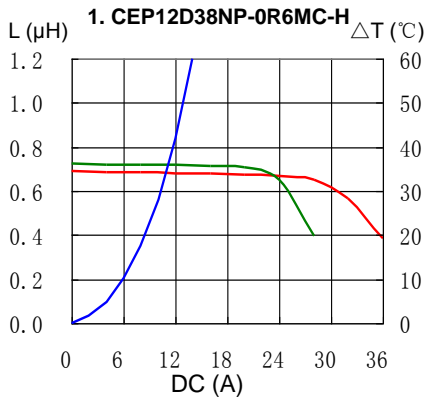

SMD Power Inductor CEP12D38



Solder Reflow Condition

Heat Endurance

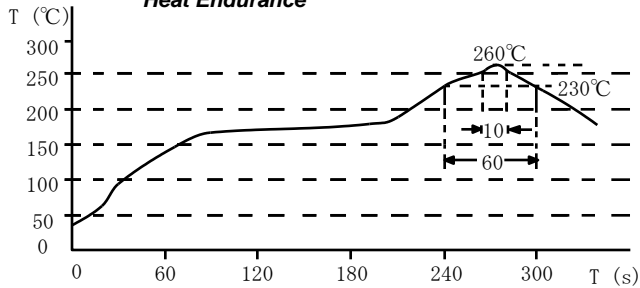

Temperature Chart

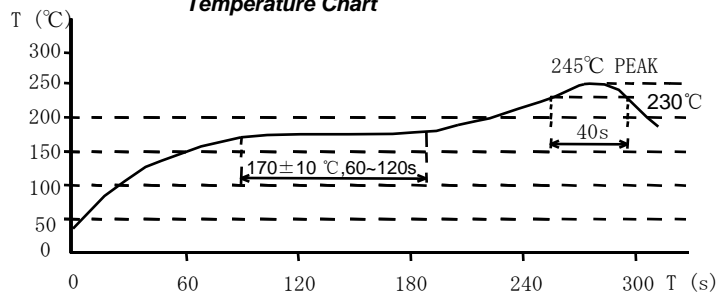

Please refer to the sales offices on our website - <http://www.sumida.com>

Hong Kong

Tel.+852-2880-6781
FAX.+852-2565-9600
sales@hk.sumida.com

Saitama(Japan)

Tel.+81-48-691-7300
FAX.+81-48-691-7340
sales@jp.sumida.com

Chicago

Tel.+1-847-545-6700
FAX. +1-847-545-6720
sales@us.sumida.com

Shanghai

Tel.+86-21-5836-3299
FAX.+86-21-5836-3266
shanghai.sales@cn.sumida.com

Seoul

Tel.+82-2-6237-0777
FAX.+82-2-6237-0778
sales@kr.sumida.com

Obernzell

Tel.+49-8591-937-0
FAX. +49-8591-937-103
contact@eu.sumida.com

Shenzhen

Tel.+86-755-8291-0228
FAX.+86-755-8291-0338
shenzhen.sales@cn.sumida.com

Singapore

Tel.+65-6296-3388
FAX.+65-6841-4426
sales@sg.sumida.com

Neumarkt

Tel.+49-9181-4509-110
FAX. +49-9181-4509-310
infocomp@eu.sumida.com

Taipei

Tel.+886-2-8751-2737
FAX.+886-2-8751-2738
sales@tw.sumida.com

San Jose

Tel.+1-408-321-9660
FAX.+1-408-321-9308
sales@us.sumida.com