

JBX
Push Pull

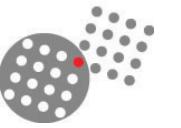

JBX Push Pull

High reliability where quick, simple coupling mechanism is required

- | | | |
|--------------------------------|---|---|
| Secure, quick confirmed mating | ✓ | Tactile, Audible, Visual |
| Blind mate capability | ✓ | Mechanically keyed - prevents accidental engagement of wrong connector |
| A versatile product | ✓ | * Ergonomic design, fast and easy to use * Modular design * 5 shell sizes * Solder, crimp, PCB, R/A PCB contact terminations |
| Space Saving | ✓ | * Small footprint, allows access in tight applications * High density layouts 2 - 30 pins |
| Economical | ✓ | Multiple cable collets / single part number |
| Rugged | ✓ | Metal shielding housing, high vibration and shock environments |

www.souriau.com

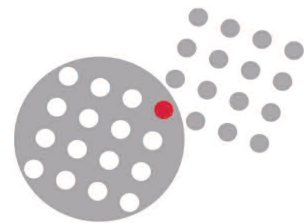

SOURIAU
Connection Technology

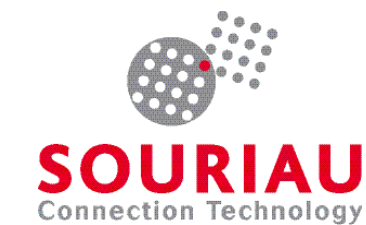

Push Pull Connectors



Push Pull Connectors



Part number system

| | | | | | | | | | | | | |
|-----------------------|---|----|---|---|----|---|---|---|---|---|---|---|
| Basic series | JBX | FD | 1 | G | 05 | M | C | S | D | S | M | R |
| Shell type-Receptacle | ER-EA-SR-PC-ED-EP-EZ-SA | | | | | | | | | | | |
| Shell type - Plug | FD-FC-FF-FM-FN | | | | | | | | | | | |
| Shell size | 00 - 0 - 1 - 2 - 3 | | | | | | | | | | | |
| Keying | G - J - A - B | | | | | | | | | | | |
| Contact layout | 02 ----- 30 | | | | | | | | | | | |
| Contact type | M : pin F : socket | | | | | | | | | | | |
| Contact termination | C: crimp; S: solder; P*: straight PCB tails ; Q*: Right Angle PCB tails | | | | | | | | | | | |
| Surface plating | S : Outer shell brass alloy chrome over nickel plating N : Outer shell in brass alloy with black plating (consult Souriau USA) | | | | | | | | | | | |
| Obligatory Suffix | D : For all part numbers | | | | | | | | | | | |
| Contact Size | S : All contact diameters except .05 mm P : 0.5 mm contact dimensions only | | | | | | | | | | | |
| Cable Backnut Option | M : Connector with backnut for protective boot - Protective boot to order separately page 13 | | | | | | | | | | | |
| Key Identifier | R : Red dot on shell for ED, ER, EZ, PC, SR, FC, FD, FF, FM & FN only | | | | | | | | | | | |

* For receptacles with female contacts only.

Shell Types

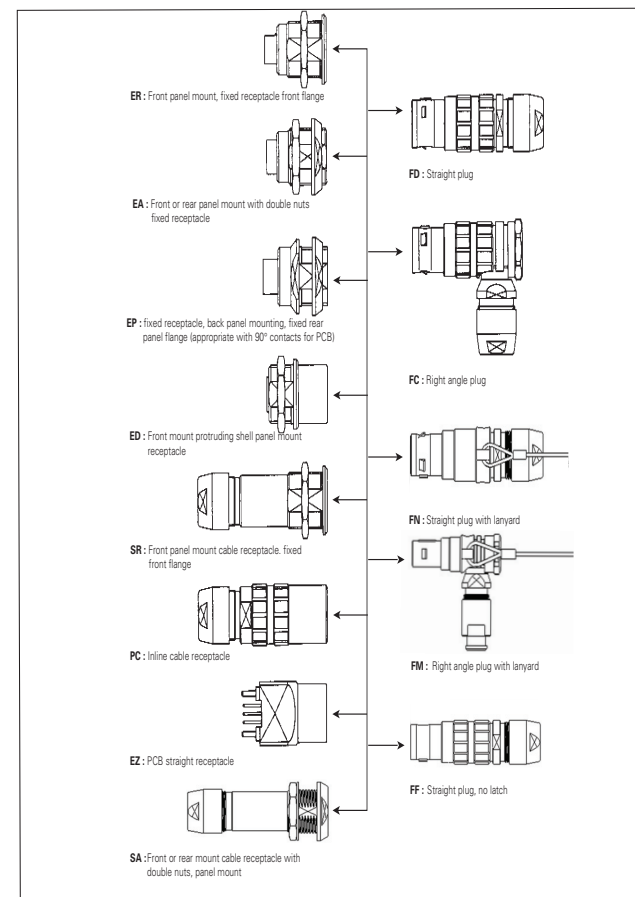

Technical characteristics

Environmental

- * IP40 & IP 67/68
- * Temperature range: IP40 -40° - +125°C
- * Temperature range: IP67/68 -40° - +80°C
- * Shielding effectivity: 55dB up to 100MHz

Mechanical

- * Shell: Brass alloy
- * Shell plating: Chrome over nickel
- * Insulator: Peek
- * Contact: Brass
- * Contact plating: Gold
- * Up to 8 key options
- * 7 Color code options
- * 5 Shell sizes
- * >1,000 Mating cycles

Electrical

- * Contact termination: Solder, Crimp PCB, R/A PCB
- * Contact rating:

| | |
|-------|---------------|
| 0.5mm | 2.0-2.5 Amp |
| 0.7mm | 5.0-7.0 Amp |
| 0.9mm | 7.0-10.0 Amp |
| 1.3mm | 11.0-15.0 Amp |
| 1.6mm | 15.0-17.0 Amp |
| 2.0mm | 25.0-30.0 Amp |

Contacts layouts

| Shell size 2 | | | | | | | |
|--------------------------|-----|-----|-----|-----|-----|-----|-----|
| | 02 | 03 | 04 | 05 | 06 | 07 | 08 |
| Male Insulator Wire Side | | | | | | | |
| Solder | S | S | S | S | S | S | S |
| Crimp | C | C | C | C | C | C | C |
| PCB Straight Tails* | XX | XX | P | P | P | P | P |
| PCB Right Angle* | | | Q | Q | Q | Q | Q |
| Contact Diameter mm | 1.3 | 1.3 | 1.3 | 1.3 | 1.3 | 1.3 | 0.9 |

| Shell size 2 | | | | | |
|--------------------------|-----|-----|-----|-----|-----|
| | 10 | 12 | 16 | 18 | 19 |
| Male Insulator Wire Side | | | | | |
| Solder | S | S** | S** | S** | S** |
| Crimp | C | C | C | C | C |
| PCB Straight Tails* | P | P | P | P | P |
| PCB Right Angle* | Q | Q | Q | | |
| Contact Diameter mm | 0.9 | 0.7 | 0.7 | 0.7 | 0.7 |

| Shell size 3 | | | | | | | | | |
|--------------------------|-----|-----|-----|-----|-----|-----|-----|-----|-----|
| | 03 | 04 | 07 | 08 | 10 | 14 | 18 | 22 | 30 |
| Male Insulator Wire Side | | | | | | | | | |
| Solder | S** | S** | S | S | S | S | S | S** | S** |
| Crimp | C | C | C | C | C | C | C | C | C |
| PCB Straight Tails* | XX | XX | XX | P | P | P | P | P | P |
| PCB Right Angle* | | | | | | | | | |
| Contact Diameter mm | 2 | 2 | 1.6 | 1.3 | 1.3 | 0.9 | 0.9 | 0.7 | 0.7 |

Please contact Souriau for additional technical information

Push Pull Connectors



Contacts layouts

| Shell size 00 | |
|--------------------------|---------------|
| Male Insulator Wire Side | 04 |
| Solder | S |
| Crimp | |
| PCB Straight Tails | |
| PCB Right Angle* | |
| Contact Diameter mm | 0.5 |

| Shell size 0 | | | | | | | |
|--------------------------|---------------|---------------|---------------|---------------|---------------|---------------|---------------|
| Male Insulator Wire Side | 02 | 03 | 04 | 05 | 06 | 07 | 08 |
| Solder | S | S | S** | S** | S** | S** | S** |
| Crimp | C | C | C | C | C | C | C |
| PCB Straight Tails* | P | P | P | P | P | P | P |
| PCB Right Angle* | Q | Q | Q | Q | Q | Q | Q |
| Contact Diameter mm | 0.9 | 0.9 | 0.7 | 0.7 | 0.5 | 0.5 | 0.5 |

| Shell size 1 | | | | | | | | | |
|--------------------------|---------------|---------------|---------------|---------------|---------------|---------------|---------------|---------------|---------------|
| Male Insulator Wire Side | 02 | 03 | 04 | 05 | 06 | 07 | 08 | 10 | 12 |
| Solder | S | S | S | S | S** | S** | S** | S** | S** |
| Crimp | C | C | C | C | C | C | C | C | C |
| PCB Straight Tails* | P | P | P | P | P | P | P | P | P |
| PCB Right Angle* | | Q | Q | Q | Q | Q | Q | | |
| Contact Diameter mm | 1.3 | 1.3 | 0.9 | 0.9 | 0.7 | 0.7 | 0.7 | 0.5 | 0.5 |

**Inserts with fixed non removable contacts * For receptacles with female contacts.
Note : Contact numbering mating faces receptacle view: counterclockwise from key at position 1
 Contact numbering mating faces plug view: clockwise from key at position 1

• Voltage Test Procedure

- **The testing voltage** corresponds to the maximum voltage the connector is able to withstand in normal climatic conditions. The value is about 75% of the electrical breakdown voltage. The testing voltage level can be reached several times in connectors life, but never applied for a continuous duration.

- **The working voltage** corresponds to the maximum voltage the connector is able to withstand continuously during its life time, in real environmental conditions, even with high temperature. The value is around 1/3 of the testing voltage.

• Maximum current rating

- **This indicated maximum current rating** corresponds to the maximum current that can be applied **simultaneously on each line of the connector mated pair**, continuously during its life time, in normal climatic conditions.

Remark : If the current is applied on only one contact of the layout, then an increased current value can be achieved over a long duration.

Push Pull Connectors



| KEYING | G | Dual Key Way | | | |
|--------------|----|--------------|-------------|-----|-----|
| | | J | | A | B* |
| | | sizes 0 - 1 | sizes 2 - 3 | | |
| Keying angle | 0° | 45° | 37.5° | 30° | 60° |
| Plug | | | | | |
| Receptacle | | | | | |

Options

• Protective boot

With each JBX connector, one protective boot can accept diverse cable diameters thus the end-user can manage various cable diameters without bothering with multiple part numbers.

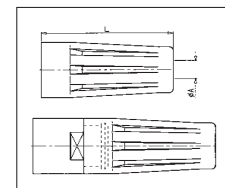

| Part number | Shell size | Dimensions | | | |
|-------------|------------|------------|----|---------|-----|
| | | Ø A | L | Ø Cable | |
| | | | | min | max |
| JBX 00 MPN | 00 | 1.5 | 15 | 1 | 3.5 |
| JBX 0 MP* | 0 | 2.2 | 20 | 1.5 | 5.5 |
| JBX 1 MP* | 1 | 2.6 | 25 | 2 | 7.5 |
| JBX 2 MP* | 2 | 4 | 30 | 3.5 | 9.7 |
| JBX 3 MP* | 3 | 5 | 35 | 4.9 | 12 |

* Color code - See chart below / In size 00, available only in black

| Color code | Colors |
|------------|--------|
| A | blue |
| B | white |
| G | grey |
| J | yellow |
| M | brown |
| N | black |
| R | red |
| V | green |
| O | orange |

Material : ELASTOLLAN (PUR)

Working temperature :

- 40°C ; + 80°C
 - 40°F ; + 176°F

Parts that require a protective boot need to be ordered with an M suffix. **Protective boots are ordered separately.**

• **Caps :** an efficient protection against dust

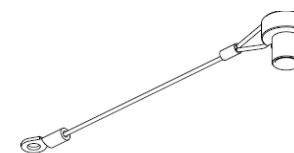

| Receptacle Caps | | Plug Caps | |
|-----------------|------------|-----------------|------------|
| Part number | Shell Size | Part number | Shell Size |
| | | JBX BF00 | 00 |
| JBX BR0 | 0 | JBX BF0 | 0 |
| JBX BR1 | 1 | JBX BF1 | 1 |
| JBX BR2 | 2 | JBX BF2 | 2 |
| JBX BR3 | 3 | JBX BF3 | 3 |

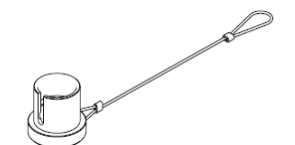

Push Pull Connectors



Dimensions - Receptacles

ER : Front mount

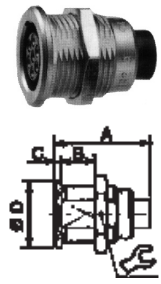

| Size | 00 | 0 | 1 | 2 | 3 |
|------|-----|-----|-----|-----|-----|
| A | 14 | 19 | 21 | 24 | 28 |
| B | 6 | 8 | 10 | 10 | 12 |
| C | 0.8 | 1.2 | 1.5 | 1.8 | 2.0 |
| Ø D | 8 | 10 | 14 | 18 | 22 |

EA : Double nut

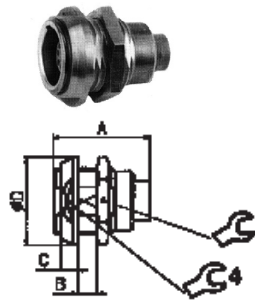

| Size | 0 | 1 | 2 | 3 |
|------|-----|-----|-----|-----|
| A | 19 | 21 | 24 | 28 |
| B | 6.7 | 8.3 | 8 | 9.5 |
| C | 2.5 | 3.2 | 3.8 | 4.5 |
| Ø D | 12 | 16 | 20 | 24 |

EP : Rear mount

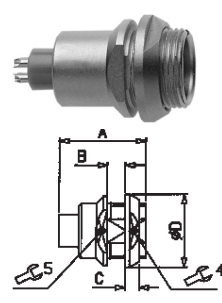

| Size | 0 | 1 | 2 |
|------|-----|-----|-----|
| A | 19 | 21 | 24 |
| B | 4.5 | 6 | 6.5 |
| C | 2.5 | 3.2 | 3.8 |
| Ø D | 12 | 16 | 20 |

SA : Double nut panel mount receptacle

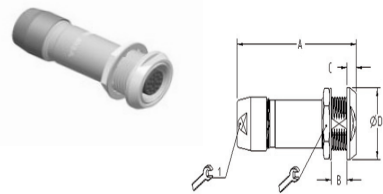

| Size | 0 | 1 | 2 | 3 |
|------|-----|-----|-----|----|
| A | 38 | 43 | 50 | 59 |
| B | - | - | 6.5 | - |
| C | 2.5 | 3.2 | 3.8 | - |
| Ø D | 12 | 16 | 20 | 24 |

ED : Front mount, protruding

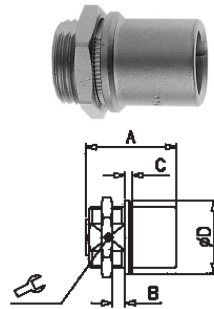

| Size | 0 | 1 | 2 |
|------|-----|-----|-----|
| A | 19 | 21 | 24 |
| B | 3 | 4.5 | 6.3 |
| C | 1.2 | 1.5 | 1.8 |
| Ø D | 10 | 14 | 18 |

SR : Front mount cable clamp

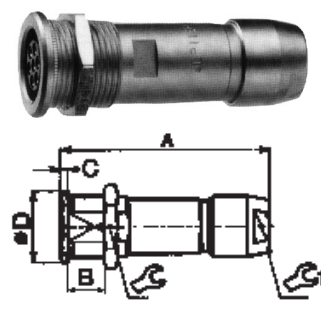

| Size | 0 | 1 | 2 | 3 |
|------|-----|-----|-----|----|
| A | 38 | 43 | 50 | 59 |
| B | 8 | 10 | 10 | 12 |
| C | 1.2 | 1.5 | 1.8 | 2 |
| Ø D | 10 | 14 | 18 | 22 |

PC : In line receptacle

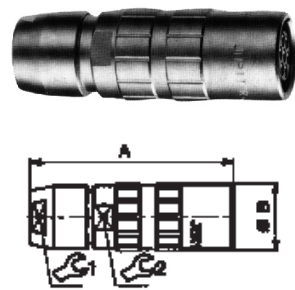

| Size | 0 | 1 | 2 | 3 |
|------|----|----|----|------|
| A | 38 | 43 | 50 | 59 |
| Ø B | 10 | 13 | 16 | 19.5 |

EZ : PCB

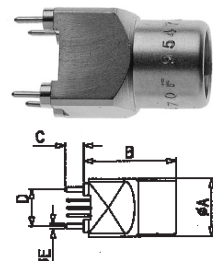

| Size | 0 | 1 |
|------|------|------|
| Ø A | 10 | 12 |
| B | 19 | 21 |
| C | 4 | 4 |
| D | 7.62 | 7.62 |
| Ø E | 1.1 | 1.1 |

Push Pull Connectors



Dimensions - Plugs

FC : Straight Plug with Lanyard

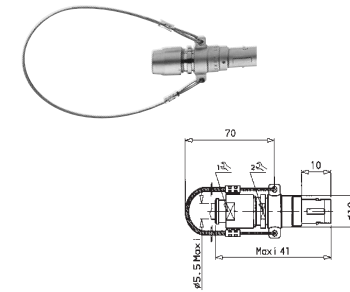

| Size | 0 | 1 | 2 | 3 |
|------|------|------|------|------|
| A | 30.5 | 36.5 | 42.5 | 50.5 |
| B | 20.5 | 25.5 | 30.5 | 35.5 |
| C | 29.5 | 33.5 | 36.5 | 45 |
| Ø D | 10 | 12 | 15 | 18 |

FM : Right angle with lanyard

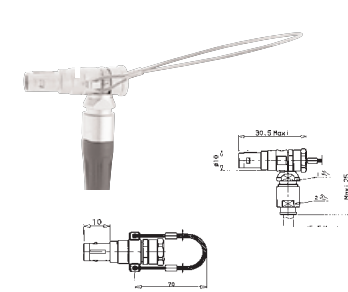

| Size | 0 | 1 | 2 | 3 |
|------|------|------|------|------|
| A | 30.5 | 36.5 | 42.5 | 50.5 |
| B | 20.5 | 25.5 | 30.5 | 35.5 |
| C | 29.5 | 33.5 | 36.5 | 45 |
| Ø D | 10 | 12 | 15 | 18 |

FF : Straight, no latch

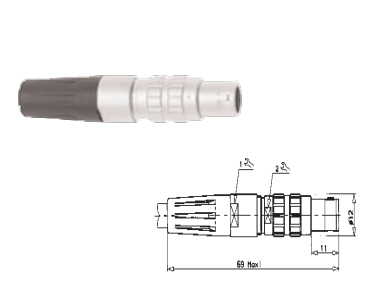

| Size | 0 | 1 | 2 | 3 |
|------|------|------|------|------|
| A | 30.5 | 36.5 | 42.5 | 50.5 |
| B | 20.5 | 25.5 | 30.5 | 35.5 |
| C | 29.5 | 33.5 | 36.5 | 45 |
| Ø D | 10 | 12 | 15 | 18 |

FN : Straight plug with lanyard

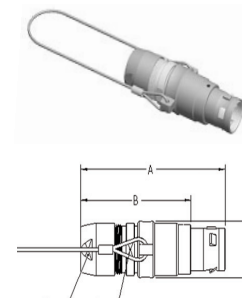

| Size | 00 | 0 | 1 | 2 | 3 |
|------|----|----|----|----|----|
| A | 31 | 39 | 45 | 52 | 62 |
| B | 23 | 29 | 34 | 40 | 47 |
| Ø C | 8 | 1 | 13 | 16 | 19 |

FC : Right angle

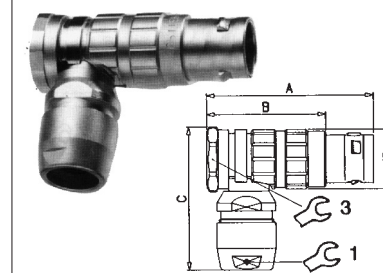

| Size | 0 | 1 | 2 | 3 |
|------|------|------|------|------|
| A | 30.5 | 36.5 | 42.5 | 50.5 |
| B | 20.5 | 25.5 | 30.5 | 35.5 |
| C | 29.5 | 33.5 | 36.5 | 45 |
| Ø D | 10 | 12 | 15 | 18 |

FD : Straight

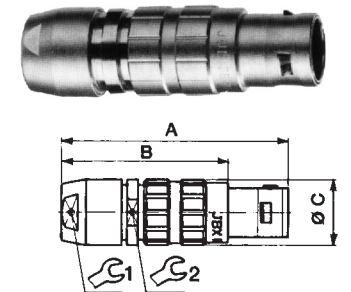

| Size | 00 | 0 | 1 | 2 | 3 |
|------|----|----|----|----|----|
| A | 31 | 39 | 45 | 52 | 62 |
| B | 23 | 29 | 34 | 40 | 47 |
| Ø C | 7 | 10 | 12 | 15 | 18 |

Range of cable diameters

With the plastic collet set supplied with the standard product, a wide range of cable diameters is allowed. Find below the maximum and the minimum for each size of shell (for information only because it can change with the cable characteristics).

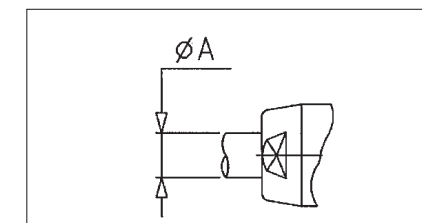

| Size | 00 | 0 | 1 | 2 | 3 |
|---------|-----|-----|-----|-----|------|
| Ø A min | 1.1 | 1.5 | 2.0 | 3.5 | 4.9 |
| Ø A Max | 3.5 | 5.5 | 7.5 | 9.7 | 12.0 |