

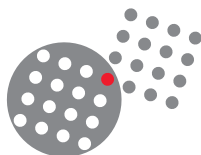

D-Subminiature Series

Rectangular Connectors



SOURIAU



D-Subminiature Series

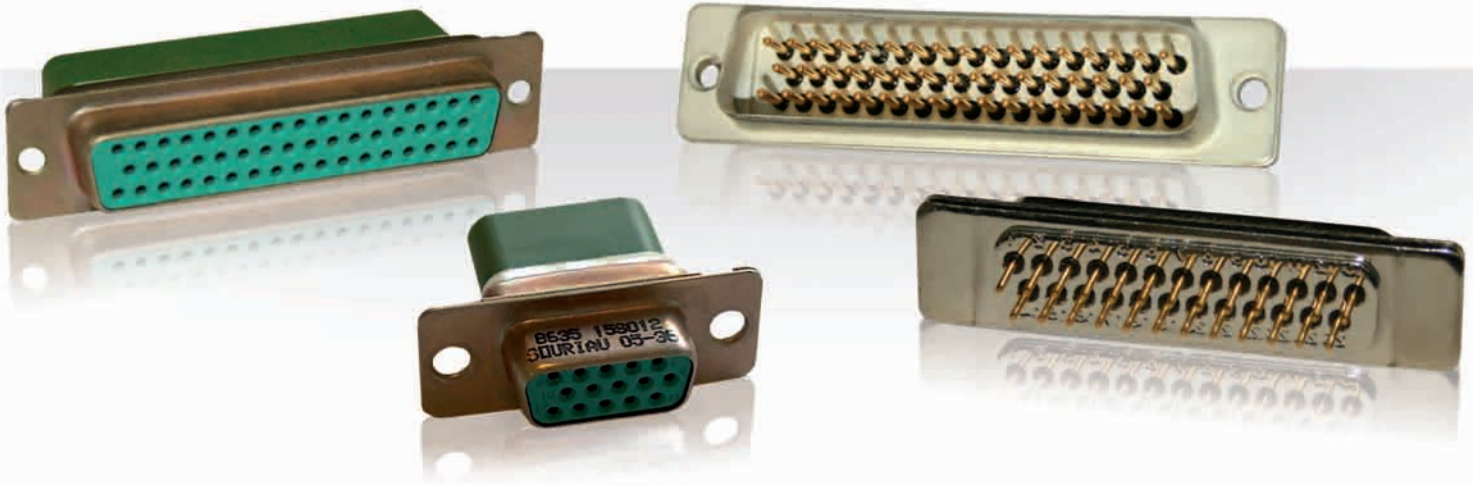

Presentation

- Souriau D-Sub connectors are used for military/aerospace applications and in industrial field: information systems, communication systems, industrial electronic...
- D-Sub connectors are designed to ensure the connection function in all applications where weight and dimension are very important.
- They are especially used as Input/Output connectors in interface fonctions. So, they are subjects to mechanical constraints that are sometimes severes.
- In order to prevent risks (pulling up, accidental unmating...), a large range of accessories is supplied.

Contents

Overview

- D-Sub Mark III standard ranges 06
- Technical characteristics 07
- Layouts 08
- PCB drilling dimensions 09

Series

- 8630 Series HE501 12
- 8630 Series HE508 14
- SMA MIL-C Series 16
- 8635 Series 19
- D-Sub hermetic connectors 21

Common Section

- Panel mounting 26
- Shell dimensions 27
- Mounting options 28

D-Sub Series



D-Subminiature Series

Overview

| | |
|--|----|
| ■ D-Sub Mark III standard ranges | 06 |
| ■ Technical characteristics | 07 |
| ■ Layouts | 08 |
| ■ PCB drilling dimensions | 09 |



D-Subminiature Series



D-Sub Mark III standard ranges

8630 Series HE 501

See page 12

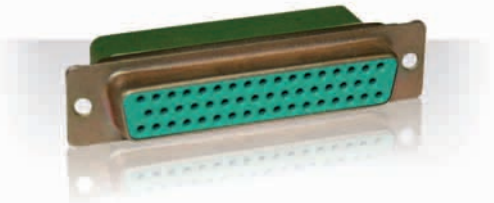

- ▶ Up to 125 °C
- ▶ Crimped contact #20

8630 Series HE 508

See page 14

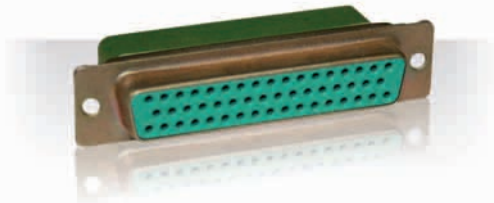

- ▶ Up to 155 °C
- ▶ Crimped contact #20

SMA MIL-C Series

See page 16

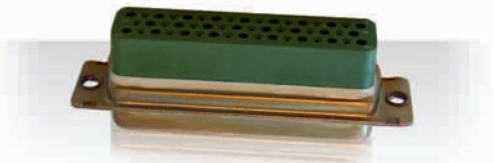

- ▶ Compliant to MIL-C- 24308
- ▶ Crimped contact #20

8635 Series

See page 19



- ▶ High Density
- ▶ Individual glass bead
- ▶ Straight spills & Crimped contact #22

Hermetic Series

See page 21



- ▶ Solder buckets and eyelets
- ▶ Straight spills & Crimped contact #20
- ▶ Hermeticity level: 10^{-7} atm.cm³/s
- ▶ Individual glass bead

D-Subminiature Series



Technical characteristics

| Characteristics | | Series | 8630 HE501 | 8630 HE508 | SMA MIL | 8635 High Density | Hermetic |
|--------------------------|---|-----------------------------------|-----------------------------------|-----------------------------|-----------------------------------|---|----------|
| | | Crimp version | Crimp version | Crimp version | Crimp or PCB version | Solder or PCB version | |
| Environmental | Temperature | -55°C to +125°C | -55°C to +155°C | -55°C to +125°C | -55°C to +155°C | -55°C to +125°C | |
| | Salt spray | 48h (cadmium) 24h (tin & zinc) | 48h (cadmium) 24h (tin & zinc) | 48h (cadmium) | 48h (cadmium) 24h (tin & zinc) | 48h (cadmium) | |
| | Damp heat | 56 days | 56 days | 56 days | 56 days | 56 days | |
| | Sealing version | No | Yes | No | Yes | Yes | |
| | Hermeticity | - | - | - | - | Under air helium differential pressure, leakage $\leq 1.04 \times 10^{-5}$ Atm.cm ² /s | |
| Standard | NFC 93425 | HE501 | HE508 | - | - | - | |
| | MIL C 24308 C | - | - | MIL | Compliant to MIL | Compliant to MIL | |
| Material | Shell | Steel | Steel | Steel | Steel | Steel | |
| | Housing | Thermoplastic | Thermodur | Thermoplastic | Thermodur | Glass bead | |
| | Contact | Copper alloy | Copper alloy | Copper alloy | Copper alloy | Ferrous alloy | |
| Plating | Shell | Cadmium Tin Zinc | Cadmium Tin Zinc | Cadmium | Cadmium Tin Zinc | Cadmium Gold Tin bright Tin mat Nickel | |
| | Contact | Gold over nickel | Gold over nickel | Gold over nickel | Gold over nickel | Gold Tin mat Nickel | |
| Electrical | Contact rating (max) | 7.5 A | 7.5 A | 7.5 A | 5 A | 5 A | |
| | Test voltage Max Vrms/50Hz | 1000 Vrms | 1000 Vrms | 1000 Vrms | 1000 Vrms | 750 Vrms | |
| | Nominal voltage Vrms/50Hz | 300 Vrms | 300 Vrms | 300 Vrms | 300 Vrms | N/A | |
| | Insulation resistance | $\geq 5000 \text{ M}\Omega$ | $\geq 5000 \text{ M}\Omega$ | $\geq 5000 \text{ M}\Omega$ | $\geq 5000 \text{ M}\Omega$ | $\geq 5000 \text{ M}\Omega$ | |
| | Contact resistance | $\leq 7.3 \text{ M}\Omega$ | $\leq 7.3 \text{ M}\Omega$ | $\leq 7.3 \text{ M}\Omega$ | $\leq 7.3 \text{ M}\Omega$ | $\leq 14 \text{ M}\Omega$ | |
| Mechanical & Dimensional | Insertion/ extraction force per contact (N) | 5N max/0.3 min | 5N max/0.3 min | 5N max/0.3 min | 5N max/0.3 min | N/A | |
| | Endurance | 500 | 500 | 500 | 500 | 500 | |
| | Contact Ø | 1 mm | 1 mm | 1 mm | 0.76 mm | 1 mm | |
| Wire | Wire gauge | AWG 20 to 28 | AWG 20 to 28 | AWG 20 to 24 | AWG 22 to 28 | N/A | |
| | Max Ø over insulator | 1.7 mm | 1.7 mm | 1.7 mm | 1.4 mm | N/A | |
| Indents version | | Available | Available | N/A | Available | N/A | |



D-Subminiature Series

Layouts

Male insulator front view

Contacts are individually numbered on both side of insulator.

Standard connectors: 8630/1 (HE501/HE508), SMA and Hermetic

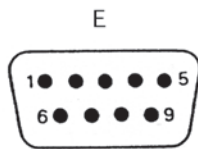

9 contacts

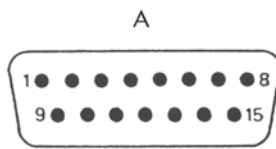

15 contacts

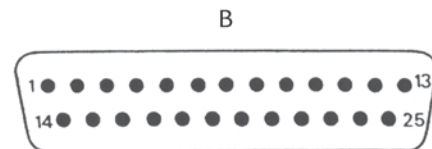

25 contacts

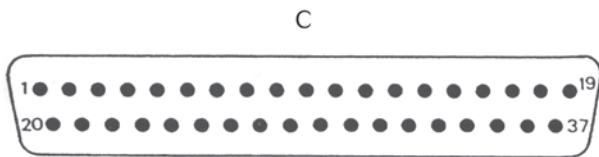

37 contacts

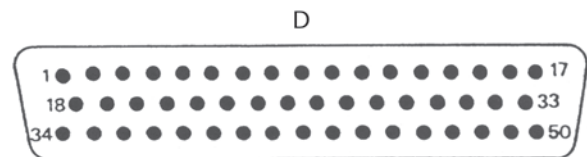

50 contacts

High density connectors: 8635

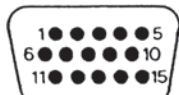

15 contacts

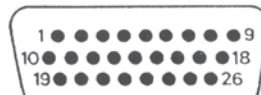

26 contacts

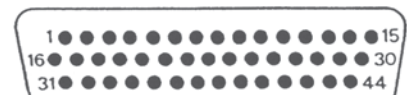

44 contacts

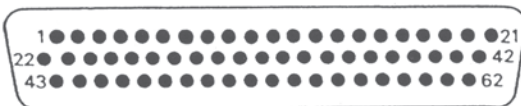

62 contacts

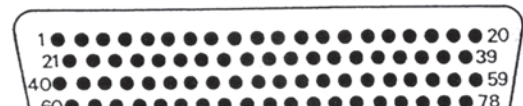

78 contacts

D-Subminiature Series



PCB drilling dimensions (mm) for solder version

Standard connectors: 8630/1 (HE501/HE508), SMA and Hermetic

Note: $\varnothing A = 0.9\text{mm}$ for HE501, HE508 and MIL C.

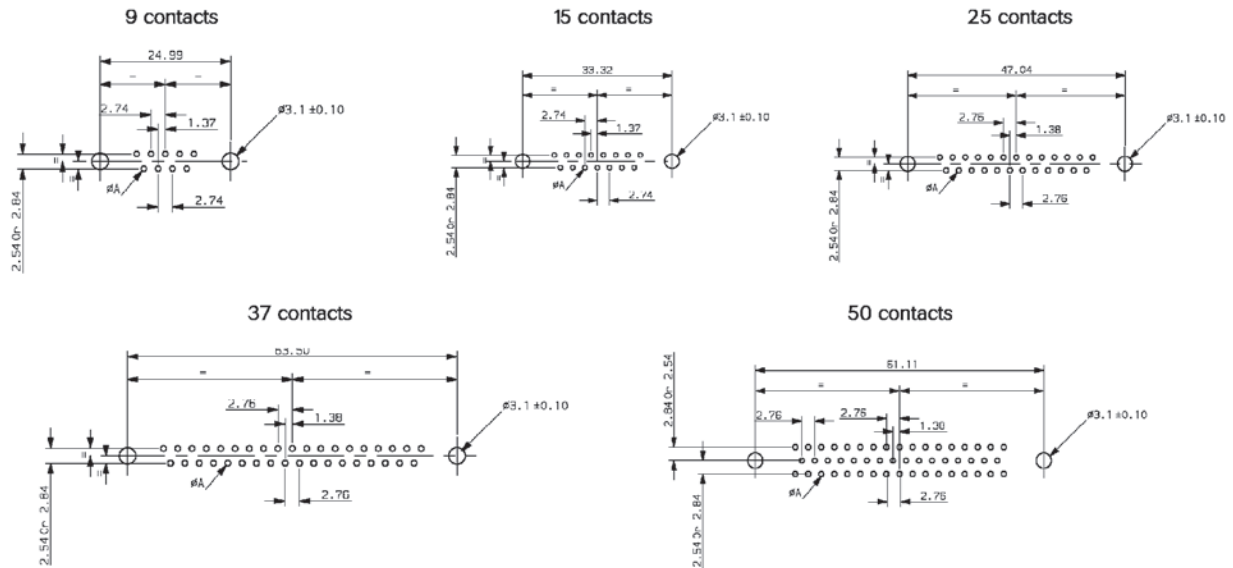

High density connectors: 8635

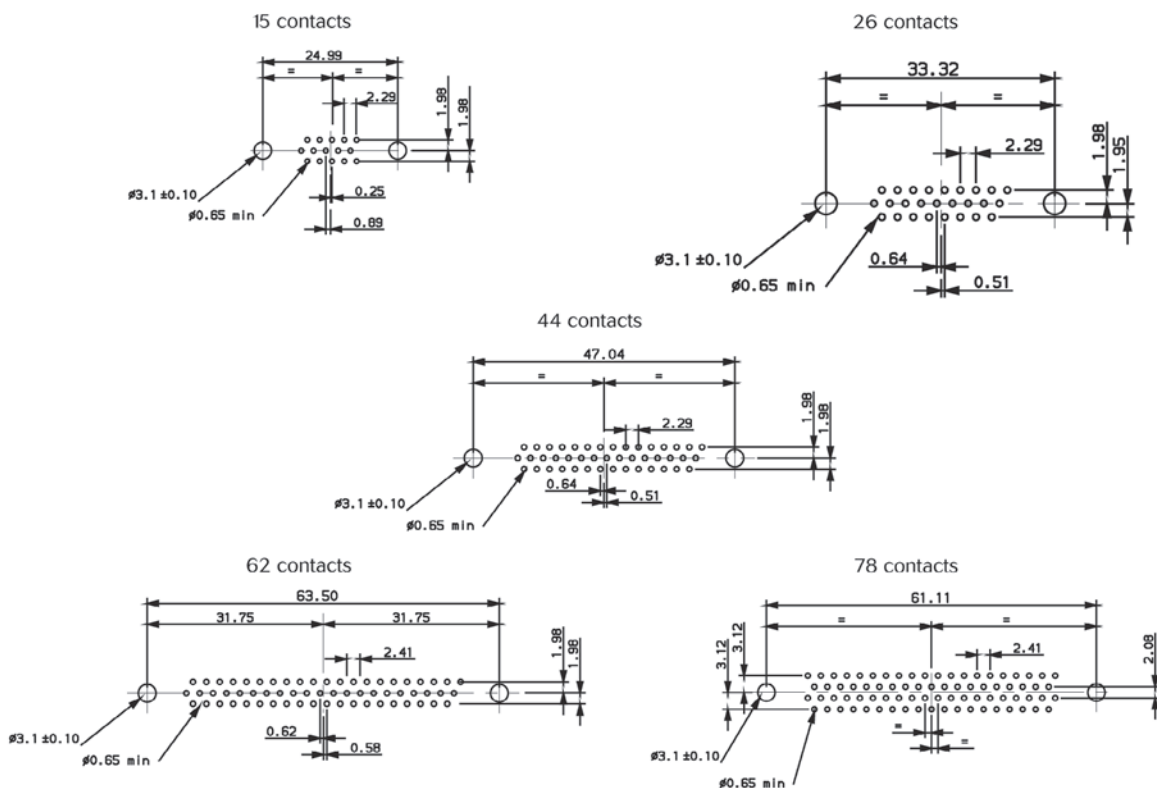

D-Sub Series



D-Subminiature Series

Series

| | |
|-----------------------------------|----|
| ■ 8630 Series HE501 | 12 |
| ■ 8630 Series HE508 | 14 |
| ■ SMA MIL-C Series | 16 |
| ■ 8635 Series | 19 |
| ■ D-Sub hermetic connectors | 21 |

D-Subminiature Series



8630 Series HE501

Connector accomodating removable machined crimp contacts for 20/24 or 26/28 AWG wires

In compliance with NFC 93425/HE501
 Standard shell plating: Cadmium
 Other platings: Tin & Zinc

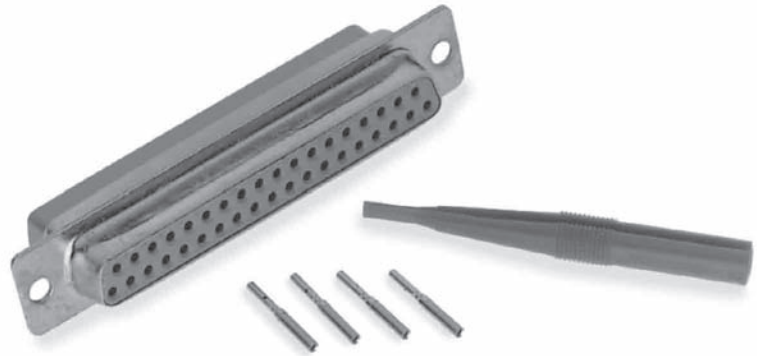

Ordering information

| | | | | |
|---|-------------|-----------|----------|----------|
| Basic Series | 8630 | 25 | P | L |
| Basic Series (float mounting) | 8631 | 25 | P | L |
| Option | | | | |
| None: Standard | | | | |
| L: Clinch nut M3 (8630 only) | | | | |
| O: Clinch nut UNC 4.40 (8630 only) | | | | |
| V: Female screw lock UNC 4.40 (8630 only) | | | | |
| Number of contacts | | | | |
| 09, 15, 25, 37, 50 | | | | |
| Contact type | | | | |
| P: Pin | | | | |
| S: Socket | | | | |
| Contacts | | | | |
| None: With standard 20/24 AWG contacts | | | | |
| L: Without contacts | | | | |
| Rear type | | | | |
| None: Standard | | | | |
| H: Shielding termination fingers (only for T plating) | | | | |
| Shell plating | | | | |
| None: Cadmium | | | | |
| T: Tin | | | | |
| Z: Zinc | | | | |
| Front type | | | | |
| None: Standard | | | | |
| X: With indents (only for front of male connector) | | | | |

D-Subminiature Series



8630 Series HE501

Removable crimp contact ordering information



| AWG | Pin | Socket | ØA |
|-----------|-----------|-----------|------|
| AWG 26/28 | 8631-4111 | 8631-6121 | 0.6 |
| AWG 20/24 | 8630-162 | 8630-165 | 1.17 |

Cross reference list for qualified part number HE501 & SOURIAU

Examples:

HE501 F 25 BP = 8631 25 P

HE501 N 37 BS = 8630 37 S

| Connector type | | HE501 | SOURIAU Reference |
|---------------------------------|----------------|--------|-------------------|
| Removal crimp contact AWG 20/24 | Standard | Pin | HE501 N ** BP |
| | | Socket | HE501 N ** BS |
| | Float mounting | Pin | HE501 F ** BP |
| | | Socket | HE501 F ** BS |

D-Subminiature Series



8630 Series HE508

Connector accomodating removable machined crimp contacts for 20/24 AWG wires

For heavy duty applications
 Class -55°C to +125°C
 Standard shell plating: Cadmium
 Other platings: Tin & Zinc
 Special proof version



Ordering information

| | | | | | | | | | | |
|---|------------|----------|-----------|----------|------------|----------|----------|--|--|--|
| Basic Series | 863 | 0 | 25 | P | 012 | L | N | | | |
| Option | | | | | | | | | | |
| 0: Standard mounting holes (Ø=3.10) | | | | | | | | | | |
| 1: Float mounting | | | | | | | | | | |
| Number of contacts | | | | | | | | | | |
| 09, 15, 25, 37, 50 | | | | | | | | | | |
| Contact type | | | | | | | | | | |
| P: Pin | | | | | | | | | | |
| S: Socket | | | | | | | | | | |
| Specification | | | | | | | | | | |
| None: Standard | | | | | | | | | | |
| 012: Splash proof | | | | | | | | | | |
| 015: Dust proof | | | | | | | | | | |
| Contacts | | | | | | | | | | |
| None: With standard 20/24 AWG contacts | | | | | | | | | | |
| L: Without contact | | | | | | | | | | |
| HE508 coding | | | | | | | | | | |
| N: Mandatory for standard version (not for 012 Splash proof version and for 015 Dust proof version) | | | | | | | | | | |
| Rear type | | | | | | | | | | |
| None: Standard | | | | | | | | | | |
| H: Shielding termination fingers (only for T plating) | | | | | | | | | | |
| Shell plating | | | | | | | | | | |
| None: Cadmium | | | | | | | | | | |
| T: Tin | | | | | | | | | | |
| Z: Zinc | | | | | | | | | | |
| Front type | | | | | | | | | | |
| None: Standard | | | | | | | | | | |
| X: With indents (only for front of male connector) | | | | | | | | | | |

D-Subminiature Series



8630 Series HE508

Cross reference list for qualified part number HE508 & SOURIAU

Example:
HE508 N 25 BP = 8630 25 PN

| Connector type | | | HE508 | SOURIAU Ref |
|------------------------------------|----------------|--------|---------------|-------------|
| Removal crimp contact AWG 20/24 | Standard | Pin | HE508 N ** BP | 8630 ** PN |
| | | Socket | HE508 N ** BS | 8630 ** SN |
| | Float mounting | Pin | HE508 F ** BP | 8631 ** PN |
| | | Socket | HE508 F ** BS | 8631 ** SN |

Special proof versions (available in HE508 Series only)

Examples:
8630 25 P012
012: Splash proof version, grommet + potting = male interface seal conform to IP65.
8630 25 P015
015: Dust proof version, rear grommet only.

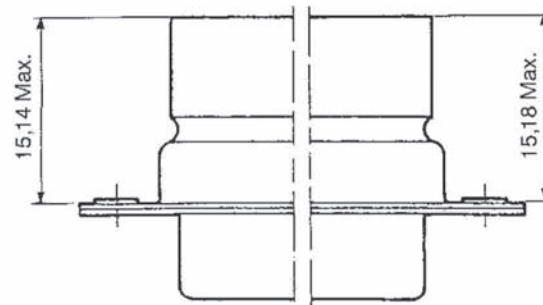



D-Subminiature Series

SMA MIL-C Series

MIL C 24308 C
Connector accomodating
removable machined
crimp contacts for 20/24
AWG wires

Class -55°C to +125°C
 Shell plating: Cadmium
 Contact #20



Ordering information

| | | | | | | | |
|---|---|---|----|----|---|---|---|
| Basic Series | S | B | MA | 25 | P | L | N |
| Shell size E, A, B, C, D | | | | | | | |
| S-MA Series MA: Mandatory | | | | | | | |
| Option None: Standard F: Float mounting | | | | | | | |
| Number of contacts 09, 15, 25, 37, 50 | | | | | | | |
| Type P: Pin S: Socket | | | | | | | |
| Contact None: With MIL contacts L: Without MIL contacts | | | | | | | |
| QPL version N: Mandatory for classified QPL version | | | | | | | |

Diameter of insulator cable max: 1.6 mm.
 This series can be ordered directly with MIL part number.

D-Subminiature Series



SMA MIL-C Series

Crimp contact for AWG 20/24 wire

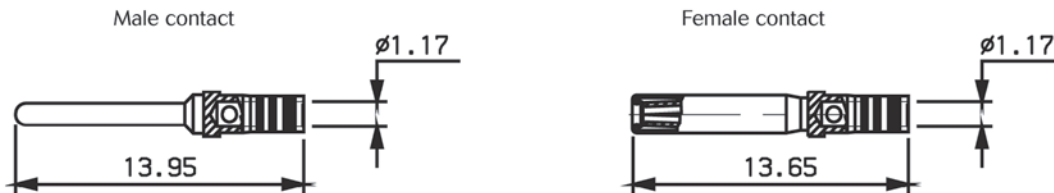

MIL C 24308 C contact

| AWG | Contact type | SOURIAU P/N | Reference | Colour code |
|-------|--------------|-------------|---------------|-------------------|
| 20/24 | Pin | 8630 3020 A | M39029/64-369 | Orange/Blue/White |
| | Socket | 8630 3022 A | M39029/63-368 | Orange/Blue/Grey |

Tool part number for 8630 Series

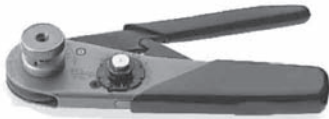

| Tools | PN | Standard | SOURIAU |
|-------------------------|----|-------------|-----------|
| | | M22520/2-01 | 8476-01 |
| Locator | | M22520/2-08 | 8476-08 |
| Extraction plastic tool | | - | 8630-06A |
| MIL extraction tool | | M81969/1-02 | 8630-3330 |

D-Subminiature Series



SMA MIL-C Series

MIL Vs SOURIAU cross reference

| Connector type | Male connector | | Female connector | |
|--------------------------------|----------------|-----------|------------------|------------|
| | MIL C 24308 C | SOURIAU | MIL C 24308 C | SOURIAU |
| Standard with contact | M24308/4-1F | SEMA09PN | M24308/2-1F | SEMA09SN |
| | M24308/4-2F | SAMA15PN | M24308/2-2F | SAMA15SN |
| | M24308/4-3F | SBMA25PN | M24308/2-3F | SBMA25SN |
| | M24308/4-4F | SCMA37PN | M24308/2-4F | SCMA37SN |
| | M24308/4-5F | SDMA50PN | M24308/2-5F | SDMA50SN |
| Standard without contact | M24308/4-259F | SEMA09PLN | M24308/2-281F | SEMA09SLN |
| | M24308/4-260F | SAMA15PLN | M24308/2-282F | SAMA15SLN |
| | M24308/4-261F | SBMA25PLN | M24308/2-283F | SBMA25SLN |
| | M24308/4-262F | SCMA37PLN | M24308/2-284F | SCMA37SLN |
| | M24308/4-263F | SDMA50PLN | M24308/2-285F | SDMA50SLN |
| Float mounting with contact | M24308/4-302F | SEMAF09PN | M24308/2-342F | SEMAF09SN |
| | M24308/4-303F | SAMAF15PN | M24308/2-343F | SAMAF15SN |
| | M24308/4-304F | SBMAF25PN | M24308/2-344F | SBMAF25SN |
| | M24308/4-305F | SCMAF37PN | M24308/2-345F | SDMAF37SN |
| | M24308/4-306F | SDMAF50PN | M24308/2-346F | SEMAF50SN |
| Float mounting without contact | | | M24308/2-482F | SEMAF09SLN |
| | | | M24308/2-483F | SAMAF15SLN |
| | | | M24308/2-484F | SBMAF25SLN |
| | | | M24308/2-485F | SCMAF37SLN |
| | | | M24308/2-486F | SDMAF50SLN |

D-Subminiature Series



8635 Series

High density connector

SOURIAU 8635 connector for aerospace and military applications offer high density (size 22) crimp and straight spill contacts in standard A, B, C, D, E shells.

The 8635 connector meet the requirements of MIL C 24308 dust and splash proof specifications.

Standard shell plating: Cadmium
Other platings: Tin & Zinc



Ordering information

| | | | | | | | | | |
|---------------------------|--|----|---|-----|---|--|--|--|--|
| Basic Series | 8635 | 44 | P | 012 | L | | | | |
| Option | <p>None: Standard mounting holes (Ø=3.10) F: Float mounting L: Clinch nut M3 O: Clinch nut UMC 4.40 V: Female screw lock UNC 4.40</p> | | | | | | | | |
| Number of contacts | 15, 26, 44, 62, 78 | | | | | | | | |
| Contact type | <p>P: Pin S: Socket</p> | | | | | | | | |
| Specification | <p>None: Standard 012: Splash proof 015: Dust proof 017: Straight spills</p> | | | | | | | | |
| Contacts | <p>None: With standard 20/24 AWG contacts L: Without contact</p> | | | | | | | | |
| Rear type | <p>None: Standard H: Shielding termination fingers (only for T plating)</p> | | | | | | | | |
| Shell plating | <p>None: Cadmium T: Tin Z: Zinc</p> | | | | | | | | |
| Front type | <p>None: Standard X: With indents (only for front of male connector)</p> | | | | | | | | |

Diameter of insulator cable max: 1.4 mm.

D-Subminiature Series



8635 Series

Dimensions

Standard version
(crimp contacts)

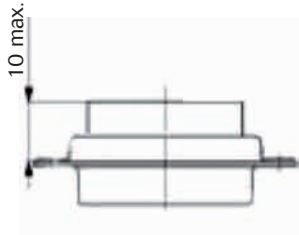

Straight spill version
(spec 017)

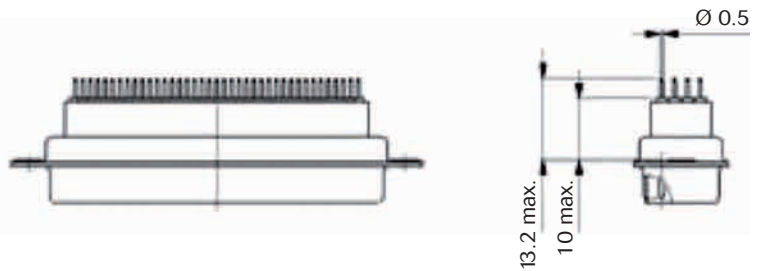

Contact part numbers

| | Type | Part number |
|-------------|--------|-------------|
| Standard | Pin | 8635-4100 |
| | Socket | 8635-9100 |
| MIL C 24308 | Pin | 8635-4110 |
| | Socket | 8635-9110 |

Tooling part numbers

| Contact size | Contact type | Plier Part number | | Locator Part number | | Plastic insertion/extraction tool Part number |
|--------------|--------------|-------------------|-------------|---------------------|-------------|---|
| | | Souriau | Standard | Souriau | Standard | Standard |
| #22D | Pin | 8476-01 | M22520/2-01 | 8476-09 | M22520/2-09 | M81969 14-01 |
| | Socket | | | 8476-06 | M22520/2-06 | |



D-Subminiature Series

D-Sub hermetic connectors

D-Sub hermetic connector

Hermetic rectangular connectors are manufactured with glass bead insulator.

They are used in all applications requiring perfect hermeticity.

Shell housing may be solder or screw mounted.

3 types of contacts terminations are available: Solder bucket, Solder eyelet or Straight spill.

They are compliant to MIL C 24308 C.

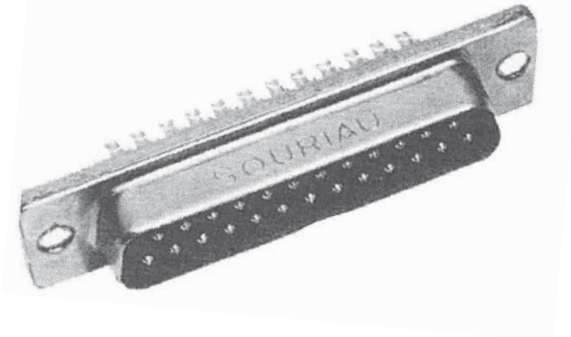

Dimensions (mm)

| Shell size | A _{0/+0.30} | B | C Screw mounting | D | E _{0/+0.30} | G max | H _{+/-0.20} | J _{+/-0.20} | K _{+0.10 -0.20} |
|------------|----------------------|-------|------------------------|-------|----------------------|-------|----------------------|----------------------|------------------------------|
| E | 30.80 | 16.94 | 24.99 | 8.41 | 12.54 | 8.45 | 18.40 | 9.40 | 2.50 |
| A | 39.14 | 25.27 | 33.32 | | | | 23.70 | | |
| B | 53.03 | 39.00 | 47.04 | | | | 37.56 | | |
| C | 69.29 | 55.45 | 63.50 | 11.10 | 15.36 | 8.75 | 53.97 | 12.70 | 2.70 |
| D | 66.92 | 52.86 | 61.11 | | | | 50.80 | | |

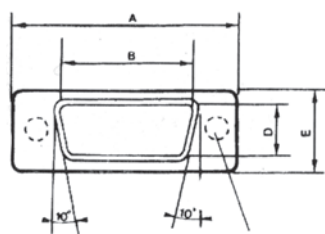

Hole $\varnothing 3.20$ $\begin{matrix} 0.10 \\ 0.05 \end{matrix}$
for screw mounting

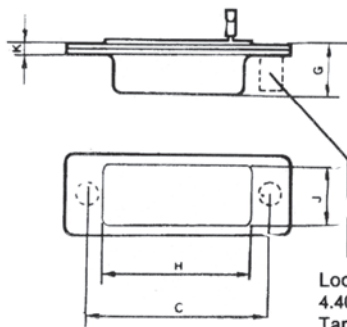

Locking stud
4.40 UNC 2B
Tapped hole

Solder bucket

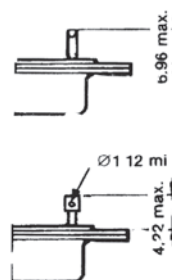

Straight spills

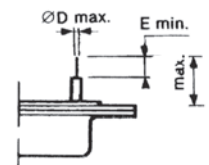



D-Subminiature Series

Part numbers & specifications

| Shell size | Plating | | Solder mounting | | | | Screw mounting | | |
|-------------|------------|----------|-------------------|----------------|----------------------|----------------|----------------|----------------|-----------|
| | Shell | Cts | With locking stub | | Without locking stub | | Solder bucket | Straight spill | Eyelet |
| | | | Solder bucket | Straight spill | Solder bucket | Straight spill | | | |
| E 9 Cts | Cadmium | Gold | DEH09P002 | DEH09P004 | DEH09P006 | DEH09P008 | DEH09P102 | DEH09P104 | - |
| | Cadmium | Gold | - | DEH09P014 | - | - | - | - | - |
| | Gold | Gold | - | - | - | - | DEH09P122 | DEH09P124 | - |
| | Tin bright | Gold | DEH09P007 | DEH09P012 | DEH09P023 | DEH09P010 | DEH09P107 | DEH09P113 | - |
| | Tin bright | Gold | - | DEH09P015 | DEH09P025 | - | - | DEH09P116 | - |
| | Tin bright | Gold | - | DEH09P016 | DEH09P005 | - | - | - | - |
| | Tin bright | Gold | - | DEH09P017 | - | - | - | - | - |
| | Tin mat | Tin mat | - | - | - | DEH09P009 | - | - | - |
| | Nickel | Nickel | - | - | - | - | - | - | DEH09P121 |
| A 15 Cts | Cadmium | Gold | DAH15P002 | DAH15P004 | DAH15P006 | DAH15P008 | DAH15P102 | DAH15P104 | - |
| | Cadmium | Gold | - | DAH15P014 | - | - | - | - | - |
| | Gold | Gold | - | - | - | - | DAH15P122 | DAH15P124 | - |
| | Tin bright | Gold | DAH15P007 | DAH15P012 | DAH15P023 | DAH15P010 | DAH15P107 | DAH15P113 | - |
| | Tin bright | Gold | - | DAH15P015 | DAH15P005 | - | DAH15P119 | DAH15P116 | - |
| | Tin bright | Gold | - | DAH15P016 | - | - | DAH15P120 | - | - |
| | Tin mat | Tin mat | - | - | - | DAH15P009 | - | - | - |
| | | | | | | | | | |
| B 25 Cts | Cadmium | Gold | DBH25P002 | DBH25P004 | DBH25P006 | DBH25P008 | DBH25P102 | DBH25P104 | - |
| | Cadmium | Gold | - | DBH25P014 | DBH25P020 | - | - | - | - |
| | Gold | Gold | - | - | - | - | DBH25P122 | DBH25P124 | - |
| | Tin bright | Gold | DBH25P007 | DBH25P011A | DBH25P023 | DBH25P010 | DBH25P107 | DBH25P113 | - |
| | Tin bright | Gold | - | DBH25P012 | DBH25P005 | - | - | DBH25P115 | - |
| | Tin bright | Gold | - | DBH25P015 | - | - | - | DBH25P116 | - |
| | Tin bright | Gold | - | DBH25P016 | - | - | - | - | - |
| | Tin bright | Gold/Tin | - | - | - | - | - | DBH25P125 | - |
| | Tin mat | Tin mat | - | - | - | DBH25P009 | - | - | - |
| C 37 Cts | Cadmium | Gold | DCH37P002 | DCH37P004 | DCH37P006 | DCH37P008 | DCH37P102 | DCH37P104 | - |
| | Cadmium | Gold | - | DCH37P014 | - | - | - | - | - |
| | Gold | Gold | - | - | - | - | DCH37P122 | DCH37P124 | - |
| | Tin bright | Gold | DCH37P007 | DCH37P012 | DCH37P023 | DCH37P010 | DCH37P107 | DCH37P113 | - |
| | Tin bright | Gold | - | DCH37P015 | DCH37P005 | DCH37P021 | - | DCH37P114 | - |
| | Tin bright | Gold | - | DCH37P016 | - | - | - | DCH37P116 | - |
| | Tin mat | Tin mat | - | - | - | DCH37P009 | - | - | - |
| | | | | | | | | | |
| D 50 Cts | Cadmium | Gold | DDH50P002 | DDH50P004 | DDH50P006 | DDH50P008 | DDH50P102 | DDH50P104 | - |
| | Cadmium | Gold | - | DDH50P014 | - | - | - | - | - |
| | Gold | Gold | - | - | - | - | DDH50P122 | DDH50P124 | - |
| | Tin bright | Gold | DDH50P007 | DDH50P012 | DDH50P023 | DDH50P010 | DDH50P107 | DDH50P113 | - |
| | Tin bright | Gold | - | DDH50P015 | DDH50P005 | - | - | DDH50P114 | - |
| | Tin bright | Gold | - | DDH50P016 | DDH50P019 | - | - | DDH50P116 | - |
| | Tin mat | Tin mat | - | - | - | DDH50P009 | - | - | - |
| | | | | | | | | | |

D-Subminiature Series



D-Sub hermetic connectors

Straight spill version dimensions

| N° specification | 004 | 008 | 009 | 010 | 011A | 012 | 014 | 015 | 016 |
|------------------|------|-----|-----|-----|------|------|------|------|------|
| L max | 7.62 | | | | 3.40 | 5.25 | 3.83 | 9.60 | 7.62 |
| E min | 6.40 | | | | 2.00 | 4.02 | 2.13 | 8.43 | 6.40 |
| ø D max | 0.83 | | | | 0.60 | 0.68 | 0.63 | 0.83 | 0.83 |

| N° specification | 017 | 021 | 104 | 113 | 114 | 115 | 116 | 124 | 125 |
|------------------|------|------|-----|------|-----|-------|------|-----|-----|
| L max | 3.83 | 7.62 | | 6.82 | | 16.35 | 7.62 | | |
| E min | 2.13 | 6.40 | | 5.60 | | 15.18 | 6.40 | | |
| ø D max | 0.60 | 0.83 | | 0.65 | | 0.85 | 0.83 | | |

Panel cut-out

| Shell size | Mounting type | A +/-0.1 | B +/-0.1 | C +/-0.1 | D +/-0.05 | E +/-0.1 | F min | G min |
|------------|---------------|-------------|-------------|-------------|--------------|-------------|-------|-------|
| E | Front | - | - | 24.99 | 3.20 | - | 18.70 | 9.70 |
| | Rear | 20.50 | 11.40 | 24.99 | 3.20 | 3.30 | - | - |
| A | Front | - | - | 33.32 | 3.20 | - | 24.00 | 9.70 |
| | Rear | 28.80 | 11.40 | 33.32 | 3.20 | 3.30 | - | - |
| B | Front | - | - | 47.04 | 3.20 | - | 37.80 | 9.70 |
| | Rear | 42.50 | 11.40 | 47.04 | 3.20 | 3.30 | - | - |
| C | Front | - | - | 63.50 | 3.20 | - | 54.20 | 9.70 |
| | Rear | 59.10 | 11.40 | 63.50 | 3.20 | 3.30 | - | - |
| D | Front | - | - | 61.11 | 3.20 | - | 51.10 | 13.00 |
| | Rear | 56.30 | 11.40 | 61.11 | 3.20 | 3.30 | - | - |

Cut-out front panel mounting
(screw mounting)

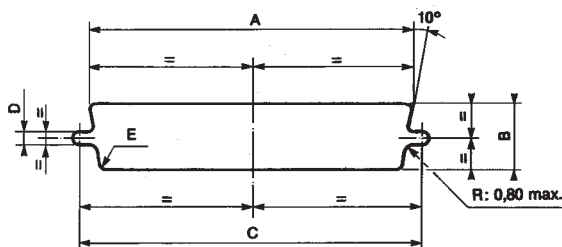

Cut-out rear panel mounting
(screw mounting)

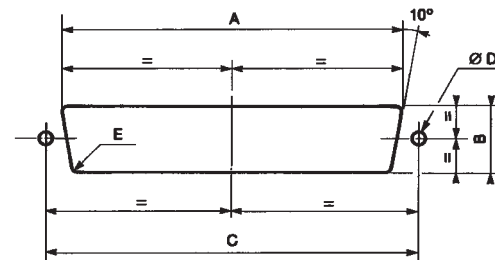

D-Sub Series



D-Subminiature Series

Common Section

| | |
|--------------------------|----|
| ■ Panel mounting | 26 |
| ■ Shell dimensions | 27 |
| ■ Mounting options | 28 |





D-Subminiature Series

Panel mounting

It is recommended that only one pair of connectors should be float mounted.
 Rigid mounted connectors require 2 screws Ø3mm.
 Float mounting connectors require Ø2mm.

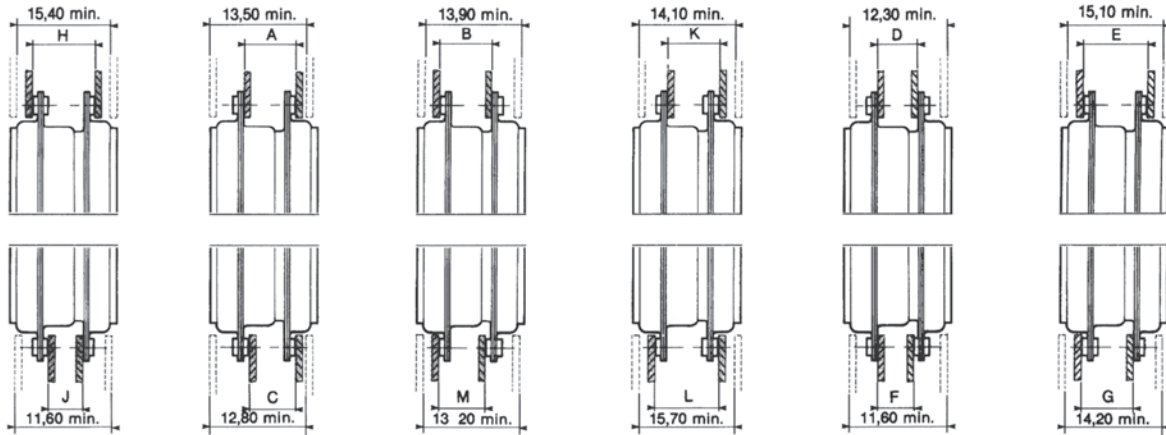

| Shell size | A 0/+0.6 | B 0/+0.6 | C 0/+0.6 | D 0/+0.6 | E 0/+0.6 | F 0/+0.6 | G 0/+0.6 | H 0/+0.6 | J 0/+0.6 | K 0/+0.6 | L 0/+0.6 | M 0/+0.6 | | | | |
|------------|-------------|-------------|-------------|-------------|-------------|-------------|-------------|-------------|-------------|-------------|-------------|-------------|--|--|------|------|
| E | 7.65 | 7.65 | 6.85 | 6.45 | 8.85 | 5.65 | 8.25 | 9.45 | 5.65 | 8.25 | 9.45 | 6.85 | | | | |
| A | | | | | | | | | | | | | | | | |
| B | | | | | 9.15 | 5.55 | 8.15 | 9.35 | 5.55 | 8.15 | 9.35 | 6.75 | | | | |
| C | 7.55 | 7.55 | 6.75 | 6.35 | | | | | | | 8.35 | | | | 9.75 | 7.15 |
| D | | | | | | | | | | | | | | | | |



D-Subminiature Series

Shell dimensions

Inner dimension
male connector

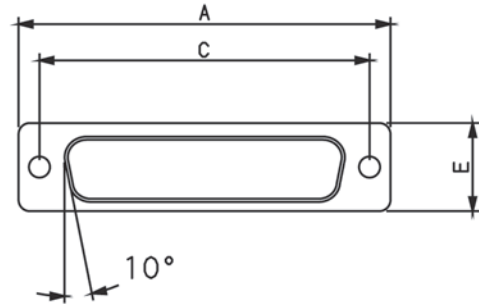
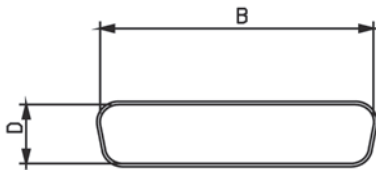

View of
mating faces

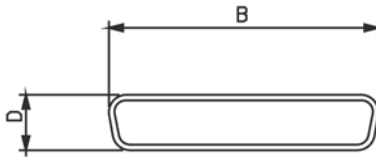
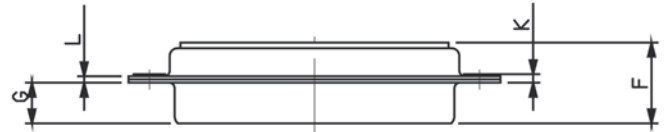

Outer view
female connector

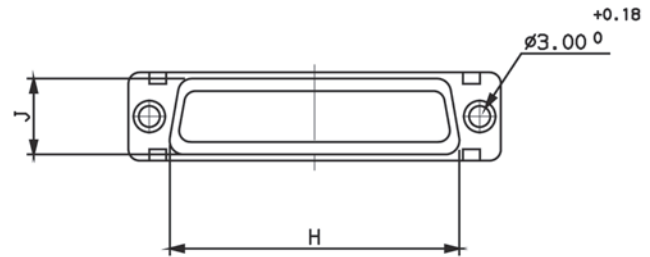

| Shell size | Contact type | A +/-0.38 | B +/-0.13 | C +/-0.13 | D +/-0.13 | E +/-0.38 | F Max | G +/-0.25 | H +/-0.25 | J +/-0.25 | K Max | L +/-0.12 |
|------------|--------------|--------------|--------------|--------------|--------------|--------------|----------|--------------|--------------|--------------|----------|--------------|
| E | Pin | 30.81 | 16.91 | 24.99 | 8.35 | 12.55 | 10.99 | 5.85 | 19.27 | 10.71 | 1.50 | 0.90 |
| | Socket | | 16.33 | | 7.89 | | 11.21 | 6.05 | | | | |
| A | Pin | 39.14 | 25.24 | 33.32 | 8.35 | | 10.99 | 5.85 | 27.50 | | | |
| | Socket | | 24.66 | | 7.89 | | 11.21 | 6.05 | | | | |
| B | Pin | 53.03 | 38.96 | 47.04 | 8.35 | | 11.07 | 5.75 | 41.27 | | | |
| | Socket | | 38.37 | | 7.89 | | 11.21 | 6.05 | | | | |
| C | Pin | 69.32 | 55.42 | 63.50 | 8.35 | 11.09 | 5.75 | 57.70 | | | | |
| | Socket | | 54.83 | | 7.89 | 11.21 | 6.05 | | | | | |
| D | Pin | 66.93 | 52.80 | 61.11 | 11.20 | 15.37 | 11.09 | 5.75 | 55.32 | 13.56 | 1.70 | 1.00 |
| | Socket | | 52.42 | | 10.74 | | 11.21 | 6.05 | | | 1.50 | 0.90 |



D-Subminiature Series

Mounting options

8630 and 8635 Series (dimensions in mm.)

F: Float mounting

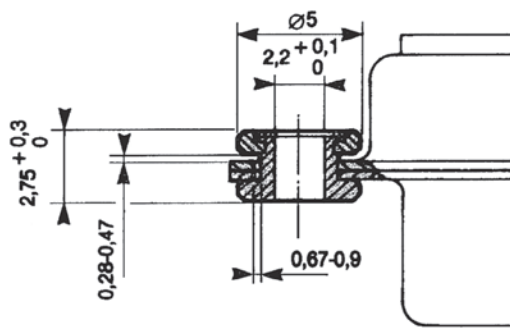

L: Clinch nut M3
O: Clinch nut UNC 4-40

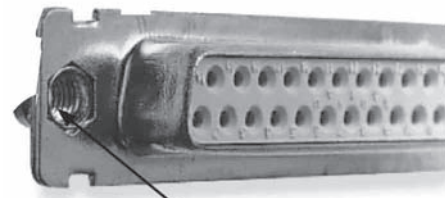

Clinch nut M3 or UNC 4-40

V: Female screw lock UNC 4-40

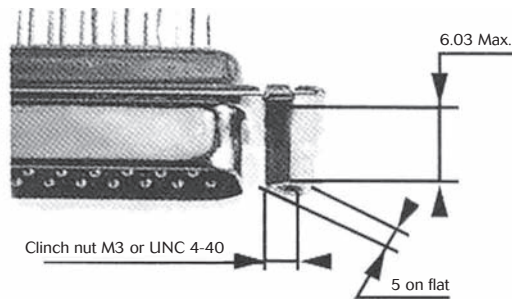

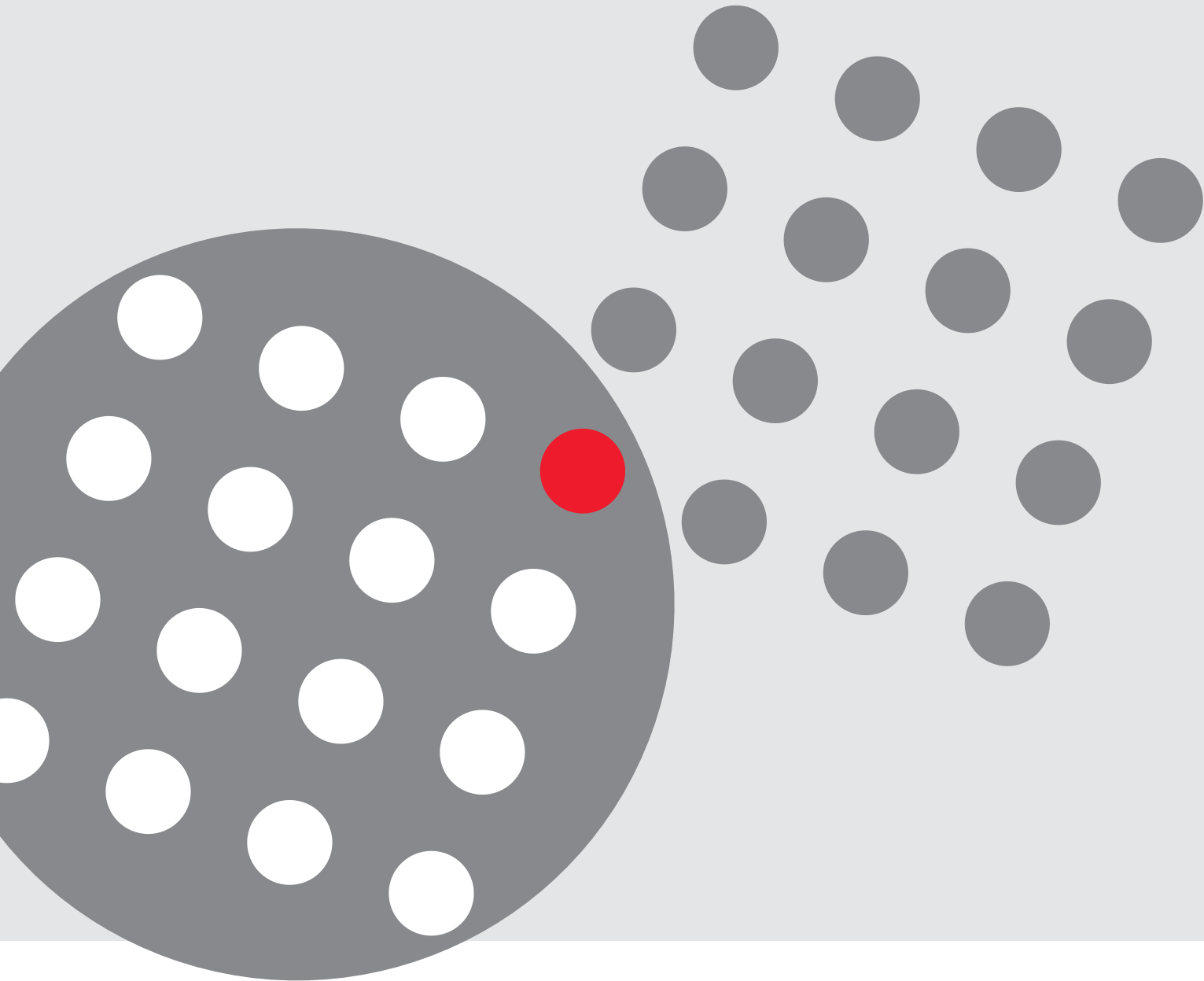

www.souriau.com
contactmilaero@souriau.com

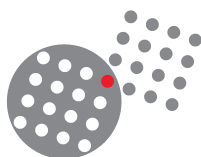

SOURIAU