

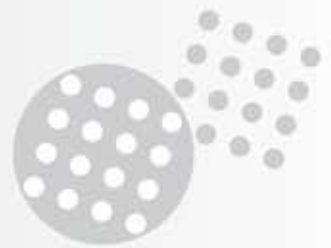

SOURIAU

Clipper Series

Industrial Plastic Connector



SOURIAU

Connectors and interconnect systems for harsh environments

The company designs, manufactures and markets high performance interconnect solutions for severe environments from industrial broadband and universal ranges to complex system with integrated functions:

filtering, high speed data transmission, hermetic seal, separation mechanism, remote handling, underwater mating, ...



Industrial



Aeronautical



Equipment & system

The dedicated end markets for SOURIAU's products are aeronautical, defense-space and industrial.



Railway
Geophysics
Manufacturing environment
Instrumentation
Automation & process



Civil & military aircraft
Helicopter
Weapon delivery system
Avionics



Military marine
Communications
Satellites
Launcher & missile

SOURIAU was established in 1917 and has been created by successive acquisitions of the industrial, aeronautical, defense and space activities of SOURIAU, JUPITER and BURNDY.

The Group's products are engineered and manufactured in the USA and Dominican Republic, Europe and Morocco, Japan and India, and sold by a worldwide sales and marketing organization, and in addition to SOURIAU's offices, a large network of licensed distributors and agents.

SOURIAU complies with most of national and international Quality Assurance Standards, production unit with ISO 14001.

**Quality Certificate
Management System**

ISO 9001

**Environment Certificate
Management System**

ISO 14001

**Quality Certificate
Management System**

Aeronautic Industry : EN 9100

Clipper Industrial Plastic Connectors



Contents

| | |
|--|----|
| <i>Description/Features/Presentation</i> | 4 |
| <i>Square flange receptacle and in-line receptacle</i> | 5 |
| <i>Plug and backnut</i> | 6 |
| <i>Electrical thread backshell</i> | 7 |
| <i>Accessories</i> | 8 |
| <i>Stamped and formed contacts</i> | 9 |
| <i>Machined contacts</i> | 10 |
| <i>IP68 configuration</i> | 11 |
| <i>IP67 configuration</i> | 13 |
| <i>Mated and unmated connectors (with backshells) overall dimensions</i> | 16 |
| <i>Dimensions (receptacle and plug)</i> | 17 |
| <i>Manual crimping tool</i> | 18 |
| <i>Automatic crimping tool</i> | 19 |
| <i>Panel mounting/panel cut-out</i> | 20 |
| <i>Wiring instruction</i> | 21 |
| <i>Assembly instruction</i> | 22 |
| <i>General technical information</i> | 24 |

Clipper Industrial Plastic Connectors

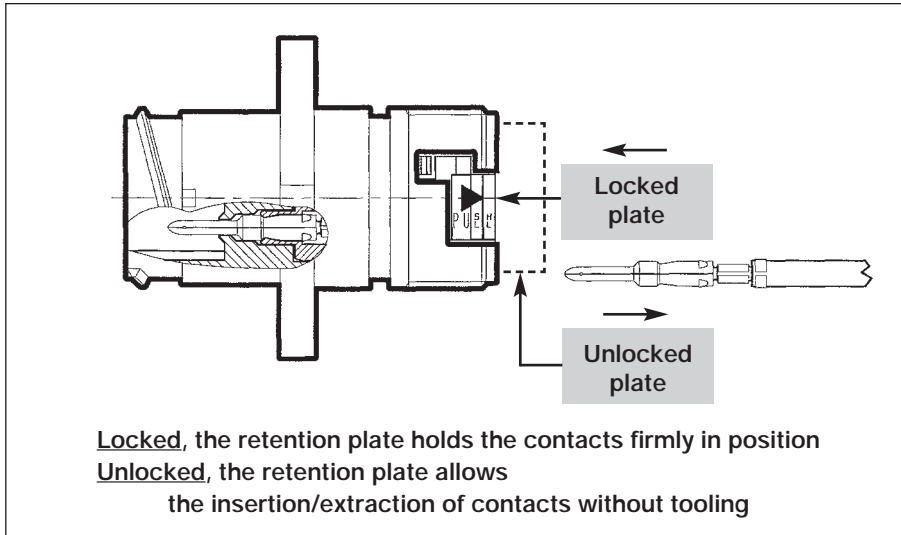

Description

Retention plate principle

Features

Mechanical

- Monobloc shell and insulator in thermoplastic material self-extinguishing to UL 94 V0.
- 180° screw coupling with positive audible safety latch.
- Scoop proof.
- Copper alloy contacts, machined or stamped and formed
- plating : gold on active part over nickel.
- Mechanical endurance :
 - connector : 250 cycles mating / unmating,
 - retention plate : 50 cycles mating / unmating.
- Retention force :
 - # 20 → 70 N
 - # 16 → 90 N.
- Vibration :
 - frequency range : 10-2000 Hz, 20 g
 - 10 cycles in accordance with CEI 68-2-6

Electrical

- Withstand voltage : 1500 Vrms min or in accordance with DIN 57110b.
- Contact resistance < 10 mW.
- Current rating per contact :
 - machined contacts :
 - # 20 (7 Amps), # 16 (13 Amps)
 - stamped and formed contacts :
 - # 20 (5 Amps), # 16 (10 Amps).

Environmental

- Sealing :
 - up to IP68
- Working temperature :
 - 40°C to +125°C. (-40°F to +257°F)
- Resistance to salt spray :
 - 48 h min
 - > 1000 h (sealed mated connectors).
- Resistance to fluids :
 - oil,
 - petrol, fuel,
 - lubricants
 - other fluids : consult us.

Presentation

CLIPPER is a plastic low cost range of industrial connectors, UL & CSA approved.

Complementing SOURIAU product range CLIPPER offers :

- a high sealing level :
 - IP67 for the sealed plug (with o'ring and mating seal)
 - IP68 for the enhanced sealed plug (with o'ring and a special mating seal). This version allows a permanent waterproof level when immersed at depths down to 30 meters.
- a retention plate system allowing insertion/extraction of the contacts without the need for tooling,
- facilities to use trade backshells with the electrical thread adaptor (PG).







CLIPPER range is composed of :

- 4 sizes of shell in molded black thermoplastic material (size 1/2/3/4).
- 7 contact layouts (4/9/14/18/26/31/40 contacts).
- #20, #16 contacts, machined or stamped and formed, crimp, solder or PC tail termination.
- An adaptor with electrical PG thread for PG backshells.
- Backnut with grommet facilities.

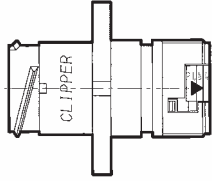
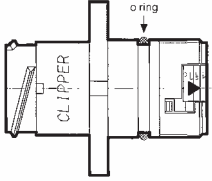
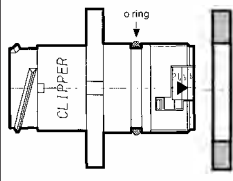
Clipper Industrial Plastic Connectors

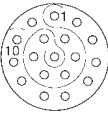
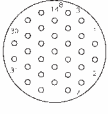
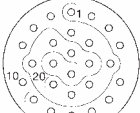
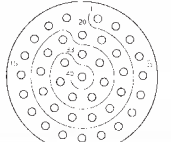

Available Style Square flange receptacle and in-line receptacle

| Contacts layouts | | Part number | | | | | | | | |
|------------------|---|---|---|---|---|--|---------------------|--------------------|---------------------|----------------------------|
| | | Unsealed receptacle (without o'ring) | | Sealed receptacle (with o'ring) for use with backshell | | Sealed receptacle (with o'ring and panel gasket) | | In-line receptacle | | |
| | |  |  |  |  | for male contacts | for female contacts | for male contacts | for female contacts | unsealed for male contacts |
| Shell sizes | 1 | 4 cts # 16  | CL1M1100 | CL1R1100 | CL1M1101 | CL1R1101 | CL1M1102 | CL1R1102 | CL1C1100 | CL1C1101 |
| | | 9 cts # 20  | CL1M1200 | | CL1M1201 | | CL1M1202 | | CL1C1200 | CL1C1201 |
| | 2 | 9 cts # 16  | CL1M2100 | CL1R2100 | CL1M2101 | CL1R2101 | CL1M2102 | CL1R2102 | CL1C2100 | CL1C2101 |
| | | 14 cts # 20  | CL1M2200 | | CL1M2201 | | CL1M2202 | | CL1C2200 | CL1C2201 |
| | 3 | 18 cts # 16  | CL1M3100 | CL1R3100 | CL1M3101 | CL1R3101 | CL1M3102 | CL1R3102 | CL1C3100 | CL1C3101 |
| | | 31 cts # 20  | CL1M3200 | | CL1M3201 | | CL1M3202 | | CL1C3200 | CL1C3201 |
| | 4 | 26 cts # 16  | CL1M4100 | | CL1M4101 | | CL1M4102 | | CL1C4100 | CL1C4101 |
| | | 40 cts # 16  | CL1M4200 | CL1R4200 | CL1M4201 | CL1R4201 | CL1M4202 | CL1R4202 | CL1C4200 | CL1C4201 |

Clipper Industrial Plastic Connectors



Plug and backnut

| | | Plug types without contacts | Part number | | | | | | | | |
|-------------|------------|-----------------------------|--|---------------------|---|------------------------------------|-------------------|---------------------|------------------------------|----------|----------|
| | | | Unsealed plug (without o'ring and mating seal) | | Sealed plug (with o'ring and mating seal) | | Sealed backnut | | Unsealed backnut | | |
| | | | for male contacts | for female contacts | for male contacts | for female contacts | for male contacts | for female contacts | for male and female contacts | | |
| Shell sizes | 1 | 4 cts # 16 | | | | | | | | | |
| | | CL1P1100 | CL1F1100 | CL1P1101 | CL1F1101 CL1F1103 (IP68) | CL111102 | CL111101 | | | CL111000 | |
| | 9 cts # 20 | | CL1F1200 | | CL1F1201 (IP67) CL1F1203 (IP68) | CL111202 | CL111201 | | | | |
| | 2 | 9 cts # 16 | CL1P2100 | CL1F2100 | CL1P2101 | CL1F2101 (IP67) CL1F2103 (IP68) | CL112102 | CL112101 | | | CL112000 |
| | | 14 cts # 20 | | CL1F2200 | | CL1F2201 (IP67) CL1F2203 (IP68) | | | | | |
| | 3 | 18 cts # 16 | CL1P3100 | CL1F3100 | CL1P3101 | CL1F3101 (IP67) CL1F3103 (IP68) | CL113102 | CL113101 | | | CL113000 |
| | | 31 cts # 20 | | CL1F3200 | | CL1F3201 (IP67) CL1F3203 (IP68) | CL113202 | CL113201 | | | |
| | 4 | 26 cts # 16 | | CL1F4100 | | CL1F4101 (IP67) CL1F4103 (IP68) | CL114102 | CL114101 | | | CL114000 |
| | | 40 cts # 16 | CL1P4200 | CL1F4200 | CL1P4201 | CL1F4201 (IP67) CL1F4203 (IP68) | CL114202 | CL114201 | | | |

Clipper Industrial Plastic Connectors



Electrical thread backshells (PG)

| Unsealed (IP40) | | | | | |
|---|--------------|----------|----------|----------|----------|
| Description | Part numbers | | | | |
| | 1 | 2 | 3 | 4 | |
| | (PG 13,5) | (PG 16) | (PG 21) | (PG 29) | (PG 36) |
| Straight backshell for flexible conduit systems | CL101040 | CL102040 | CL103040 | CL124040 | CL104040 |
| Straight cable clamp | CL101030 | CL102030 | CL103030 | CL124030 | - |

| Sealed | | | | | |
|---|--------------|----------|----------|----------|----------|
| Description | Part numbers | | | | |
| | 1 | 2 | 3 | 4 | |
| | (PG 13,5) | (PG 16) | (PG 21) | (PG 29) | (PG 36) |
| Elbow backshell with sealing gland | CL101051 | CL102051 | CL103051 | CL124051 | - |
| Straight backshell for flexible conduit systems | CL101041 | CL102041 | CL103041 | CL124041 | CL104041 |
| Anti-decoupling sealing gland backshell | CL101021 | CL102021 | CL103021 | CL124021 | CL104021 |

Note : Electrical thread backshells are always supplied complete with the adaptor.

Clipper Industrial Plastic Connectors



Accessories

Panel gasket (for square flange receptacle)

| Shell sizes | 1 | 2 | 3 | 4 |
|--------------|----------|----------|----------|----------|
| Part numbers | CL191001 | CL192001 | CL193001 | CL194001 |

90° adaptors for receptacles

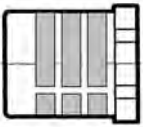

| | | | | |
|--|--|--|--|--|
| | | | | |
| | | | | |

90° adaptors for receptacles

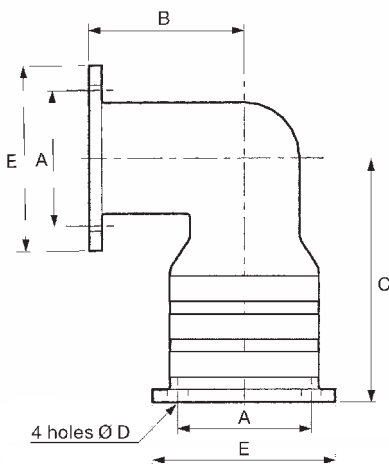

| Dim. (inches) / Shell sizes | A | B | C | D | E |
|-----------------------------|------|------|------|-----|------|
| 1 | .84 | .96 | 1.52 | .13 | 1.15 |
| 2 | .97 | 1.10 | 1.56 | .13 | 1.21 |
| 3 | 1.12 | 1.20 | 1.69 | .15 | 1.40 |
| 4 | 1.44 | 1.55 | 1.95 | .15 | 1.87 |

90° sealed adaptors for receptacles Shell 1 to 4

| Shell | Part numbers |
|-------|--------------|
| | Sealed* |
| 1 | CL131001 |
| 2 | CL132001 |
| 3 | CL133001 |
| 4 | CL134001 |

* with panel gasket

IP67 Dust cap for receptacle

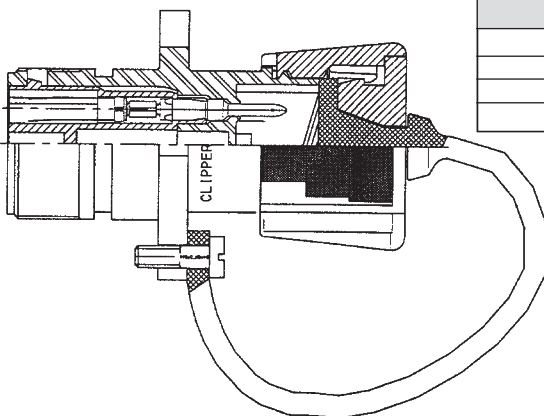





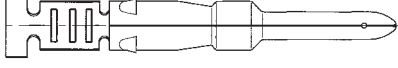

| Shell | Part number |
|-------|-------------|
| 1 | CL141001 |
| 2 | CL142001 |
| 3 | CL143001 |
| 4 | CL144001 |

Clipper Industrial Plastic Connectors

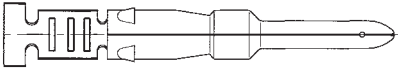

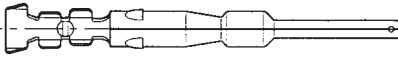
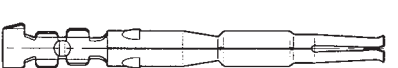
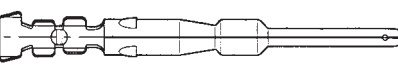
Stamped and formed contacts

| Packaging | Crimp Contact with strain relief | | Part numbers | Size | Ø mm over insulation (inches) | AWG | Admissible section mm ² |
|-----------------------|---|--------|--------------|------|---|----------|------------------------------------|
| Bulk |  | male | CF16PC10RF | 16 | 2 mm to 3 mm (0.08" to 0.12") | 18 to 16 | 0.7 to 1.5 mm ² |
| |  | female | CF16SC10RF | | | | |
| Reel 5,000 pcs. |  | male | CF16PC18RF | | | | |
| |  | female | CF16SC18RF | | | | |
| Bulk |  | male | CF10PC10RF | 20 | 1.2 mm to 2.1 mm (0.05" to 0.08") | 22 to 20 | 0.35 to 0.6 mm ² |
| |  | female | CF10SC10RF | | | | |
| Reel 5,000 pcs. |  | male | CF10PC18RF | | | | |
| |  | female | CF10SC18RF | | | | |

Plating RF : gold flash on active part for standard version (For other platings, consult FCI)

Assembly



Filler plug # 16
(for un-used contact cavities)

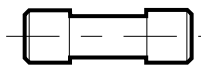

Part number : 8500 479 CL

Filler plug # 20
(for un-used contact cavities)



Part number : 8500 4144

Polarization Contact
(instruction for polarizing connector - see page 23)



Part number : CP16SW9700

Print Circuit (PC) Tail Machined Contact

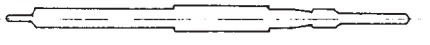
| | | | | | | |
|------|---|------|----|--|--|------------|
| Bulk |  | male | 16 | | | CM16PT10LY |
| |  | male | 20 | | | CM10PT10LY |

Clipper Industrial Plastic Connectors

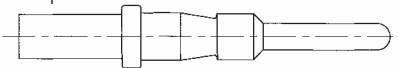
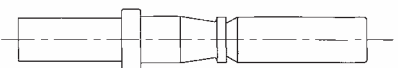
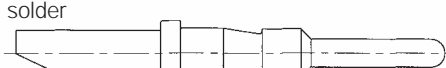
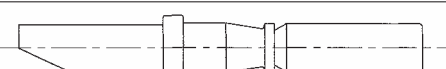
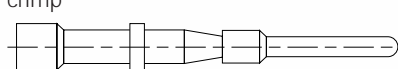
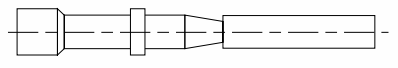
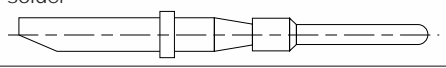
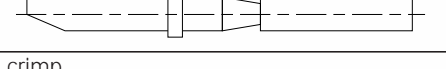
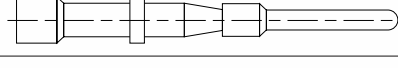
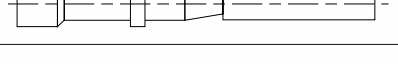
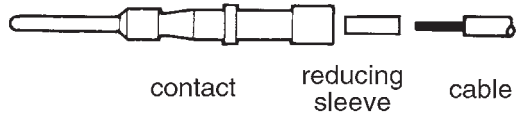

Machined contacts

| Packaging | Contact types | Part numbers | Size | Ø mm over insulation (inches) | AWG | Admissible section mm ² |
|---|---|----------------------|-----------------------------------|--------------------------------------|---------------------------------|------------------------------------|
| Bulk | crimp  | male CM16PC10MQ | 16 | 2 mm to 3 mm (0.08" to 0.12") | 18 to 14 | 0.93 to 1.91 mm ² |
| |  | female CM16SC10MQ | | | | |
| | solder  | male CM16PS10MQ | | | 14* Max | |
| |  | female CM16SS10MQ | | | | |
| | crimp  | male CM10PC10MQ | 20 | 1.2 mm to 2.1 mm (0.05" to 0.08") | 24 to 18 | 0.21 to 0.93 mm ² |
| |  | female CM10SC10MQ | | | | |
| | solder  | male CM10PS10MQ | | | 18 Max | |
| |  | female CM10SS10MQ | | | | |
| | crimp  | male CM16PC00MQ | 16 | 2 mm to 3 mm (0.08" to 0.12") | 18 to 13 | 0.93 to 2.60 mm ² |
| |  | female CM16SC00MQ | | | | |
|  | male CM16PC20MQ | 16 | 2 to 3 mm (0.08" to 0.12") | 20 | 0.21 to 0.60 mm ² | |
| | female CM16SC20MQ | | | | | |
| | male CM10PC20MQ | 20 | 1.2 to 2.1 mm (0.05" to 0.08") | 30 to 24 | 0.06 to 0.21 mm ² | |
| | female CM10SC20MQ | | | | | |

Plating MQ : 0.4µ mm gold on active part (.016µ inches) * Up to 1.91 mm²

Extended ground contact-crimp (Length + .039 inch = +1 mm)

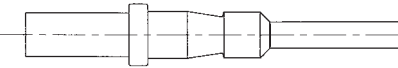
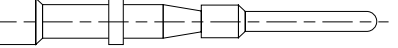
| | | | | | | |
|------|---|------|----|----------------|----------|---------------------|
| Bulk |  | male | 16 | 0.08" to 0.12" | 18 to 14 | 8501 9641 |
| |  | male | 20 | 0.05" to 0.08" | 24 to 18 | 8501 9642 CL |

Clipper Industrial Plastic Connectors



IP68 Configuration



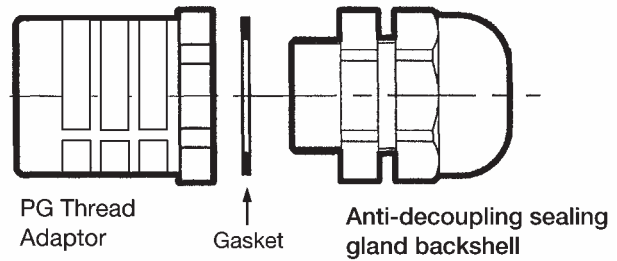
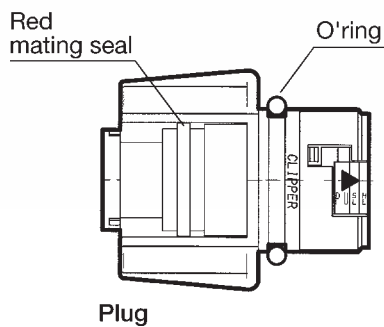
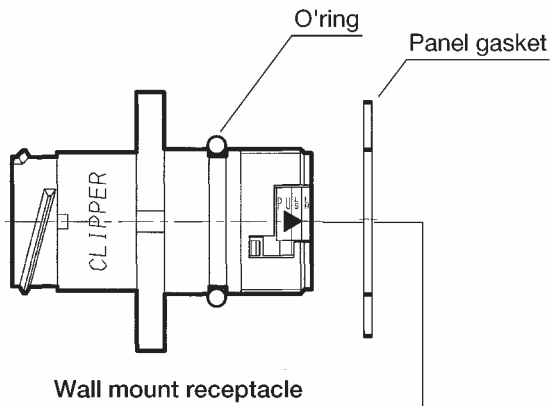





IP68 Configuration (temporary water tightness down to 100 feet)

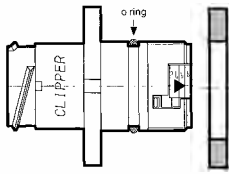
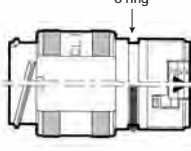
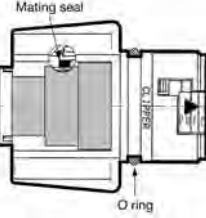
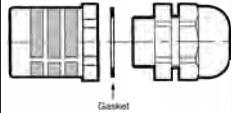

Clipper Industrial Plastic Connectors



IP68 Configuration

| | | Shell types (without contacts) and Backshell type | Part numbers | | | |
|------------------|---|--|---|---|---|--|
| | | | Sealed receptacle (with o'ring and panel gasket) | Sealed In-line receptacle | Sealed plug (with o'ring and mating seal) | Anti-decoupling sealing gland backshell |
| Contacts layouts | |  |  |  |  | |
| | | for male contacts | for male contacts | for female contacts | | |
| Shell sizes | 1 | 4 cts # 16  | CL1M1102 | CL1C1101 | CL1F1103 | CL101021 (pg 13.5) |
| | | 9 cts # 20  | CL1M1202 | CL1C1201 | CL1F1203 | |
| | 2 | 9 cts # 16  | CL1M2102 | CL1C2101 | CL1F2103 | CL102021 (pg 16) |
| | | 14 cts # 20  | CL1M2202 | CL1C2201 | CL1F2203 | |
| | 3 | 18 cts # 16  | CL1M3102 | CL1C3101 | CL1F3103 | CL103021 (pg 21) |
| | | 31 cts # 20  | CL1M3202 | CL1C3201 | CL1F3203 | |
| | 4 | 26 cts # 16  | CL1M4102 | CL1C4101 | CL1F4103 | CL124021 (pg 29) CL104021 (pg 36) |
| | | 40 cts # 16  | CL1M4202 | CL1C4201 | CL1F4203 | |

Clipper Industrial Plastic Connectors



IP67 Configuration



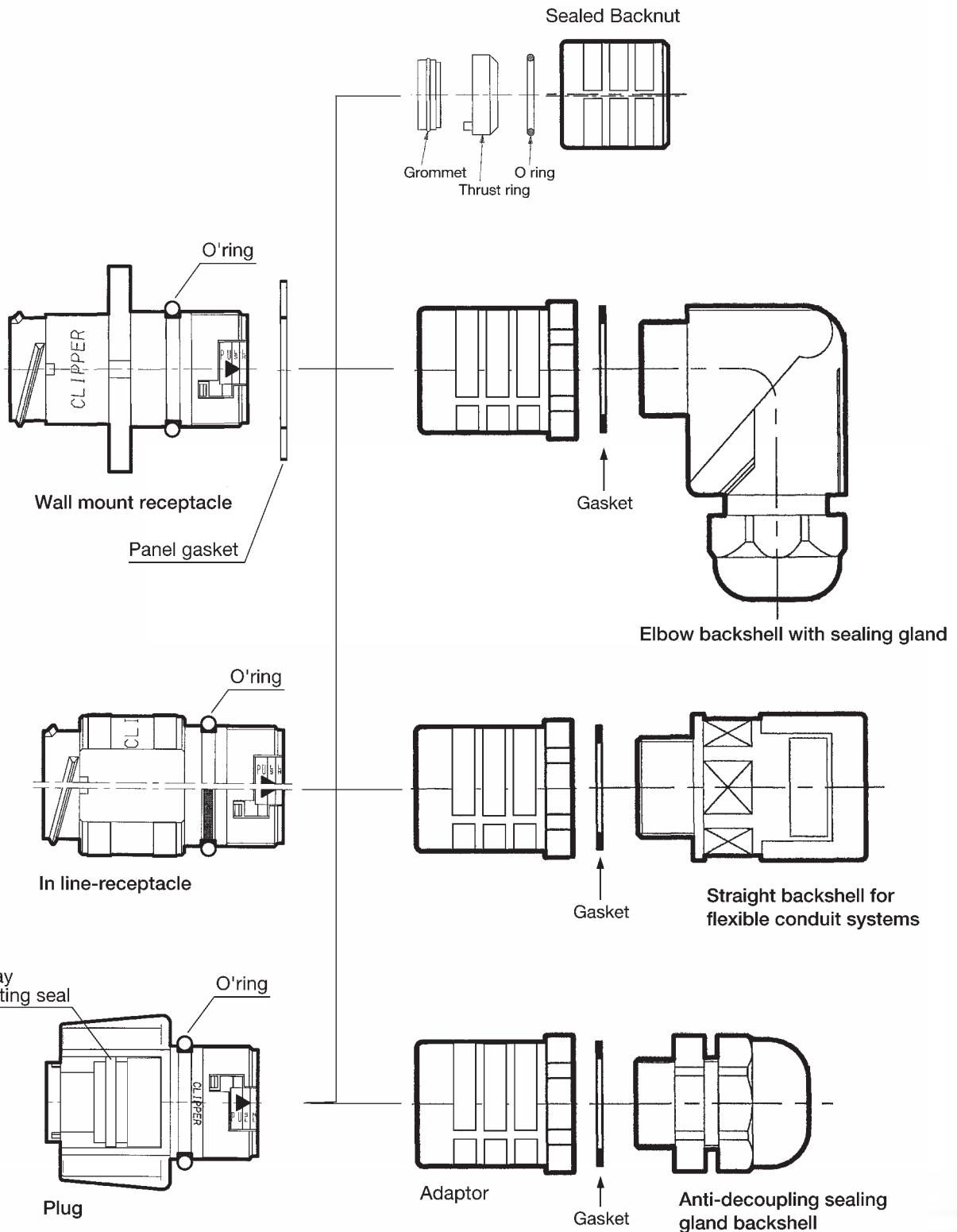





IP67 Configuration (temporary water tightness)



Clipper Industrial Plastic Connectors



IP67 Configuration

| | | Shell types without contacts | Part numbers | | | | |
|-------------|---|---|--|---------------------|---|---------------------|---------------------------|
| | | | Sealed receptacle (with o'ring and panel gasket) | | Sealed plug (with o'ring and mating seal) | | Sealed In-line receptacle |
| | | | for male contacts | for female contacts | for male contacts | for female contacts | for male contacts |
| Shell sizes | 1 | 4 cts # 16  | CL1M1102 | CL1R1102 | CL1P1101 | CL1F1101 | CL1C1101 |
| | | 9 cts # 20  | CL1M1202 | | | CL1F1201 | CL1C1201 |
| | 2 | 9 cts # 16  | CL1M2102 | CL1R2102 | CL1P2101 | CL1F2101 | CL1C2101 |
| | | 14 cts # 20  | CL1M2202 | | | CL1F2201 | CL1C2201 |
| | 3 | 18 cts # 16  | CL1M3102 | CL1R3102 | CL1P3101 | CL1F3101 | CL1C3101 |
| | | 31 cts # 20  | CL1M3202 | | | CL1F3201 | CL1C3201 |
| | 4 | 26 cts # 16  | CL1M4102 | | | CL1F4101 | CL1C4101 |
| | | 40 cts # 16  | CL1M4202 | CL1R4202 | CL1P4201 | CL1F4201 | CL1C4201 |

Clipper Industrial Plastic Connectors



IP67 Configuration

| | | Backshell types | Part numbers | | | | | | |
|-------------|---|-----------------|-------------------|---------------------|------------------------------------|---|------------------|---|------------------|
| | | | Sealed backnut | | Elbow backshell with sealing gland | Straight backshell for flexible conduit systems | | Anti-decoupling sealing gland backshell | |
| | | | for male contacts | for female contacts | | | | | |
| Shell sizes | 1 | 4 cts # 16 | CL111102 | CL111101 | CL101051 (pg 13.5) | CL101041 (pg 13.5) | | CL101021 (pg 13.5) | |
| | | 9 cts # 20 | CL111202 | CL111201 | | | | | |
| | 2 | 9 cts # 16 | CL112102 | CL112101 | CL102051 (pg 16) | CL102041 (pg 16) | | CL102021 (pg 16) | |
| | | 14 cts # 20 | | | | | | | |
| | 3 | 18 cts # 16 | CL113102 | CL113101 | CL103051 (pg 21) | CL103041 (pg 21) | | CL103021 (pg 21) | |
| | | 31 cts # 20 | CL113202 | CL113201 | | | | | |
| | 4 | 26 cts # 16 | CL114102 | CL114101 | CL124051 (pg 29) | CL124041 (pg 29) | CL104041 (pg 36) | CL124021 (pg 29) | CL104021 (pg 36) |
| | | 40 cts # 16 | CL114202 | CL114201 | | | | | |

Clipper Industrial Plastic Connectors



Mated and unmated connectors with backshells

Overall dimensions in inches

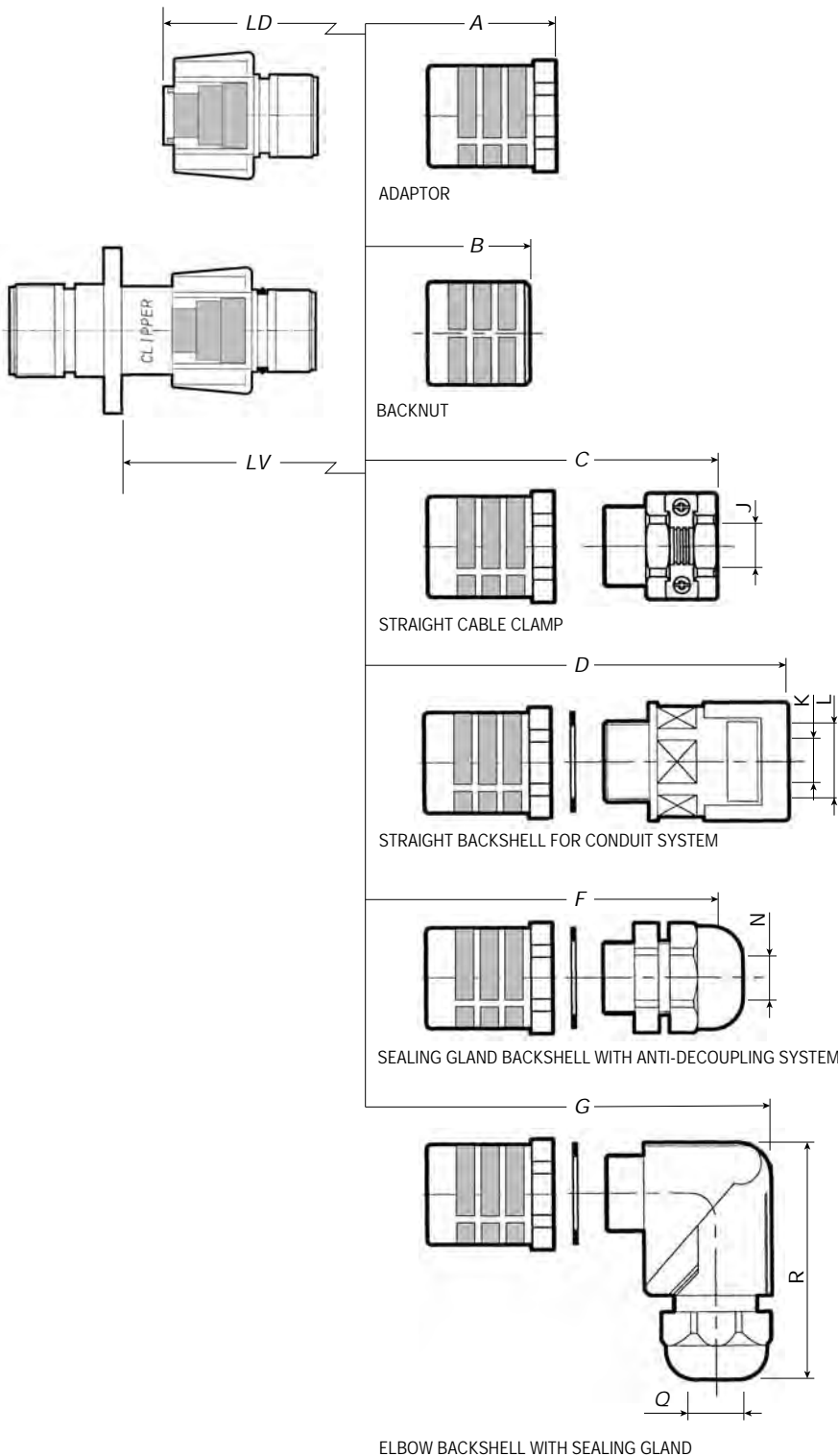

| Dimensions | | | | | |
|---------------|-------|------|------|------|----------------|
| Dim. (inches) | Shell | 1 | 2 | 3 | 4 |
| | | | | | (PG 29)(PG 36) |
| LDA | | 2.01 | 2.09 | 2.09 | 2.17 |
| LVA | | 2.29 | 2.33 | 2.33 | 2.41 |
| LDB | | 1.81 | 1.85 | 1.85 | - |
| LVB | | 2.09 | 2.09 | 2.09 | - |
| LDC | | 2.68 | 2.85 | 3.03 | 3.41 |
| LVC | | 2.97 | 3.09 | 3.27 | 3.60 |
| LDD | | 3.41 | 3.50 | 3.62 | 3.70 |
| LVD | | 3.70 | 3.74 | 3.86 | 3.94 |
| LDF | | 3.15 | 3.27 | 3.35 | 3.74 |
| LVF | | 3.43 | 3.50 | 3.58 | 3.98 |
| LDG | | 3.31 | 3.46 | 3.77 | 4.29 |
| LVG | | 3.58 | 3.70 | 4.01 | 4.52 |
| R Max. | | 2.24 | 2.34 | 2.87 | 3.58 |

| Cable acceptance* | | | | | |
|----------------------|-------|---------|---------|---------|-----------------|
| Dim. (inches) | Shell | 1 | 2 | 3 | 4 |
| | | | | | (PG 29) (PG 36) |
| J | | .24/.55 | .24/.63 | .31/.83 | .39/ 1.10 |
| Conduit L Pmaflex | | .67 | .67 | .91 | 1.14 |
| K Max | | .63 | .63 | .85 | 1.08 |
| N | | .24/.47 | .39/.55 | .51/.71 | .71/.98 |
| Q | | .24/.47 | .39/.55 | .51/.71 | .71/.98 |

* For other needs, consult FCI.

Clipper Industrial Plastic Connectors



Dimensions in inches

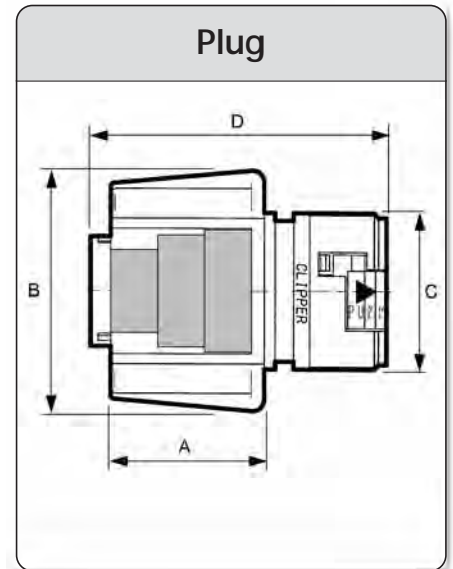
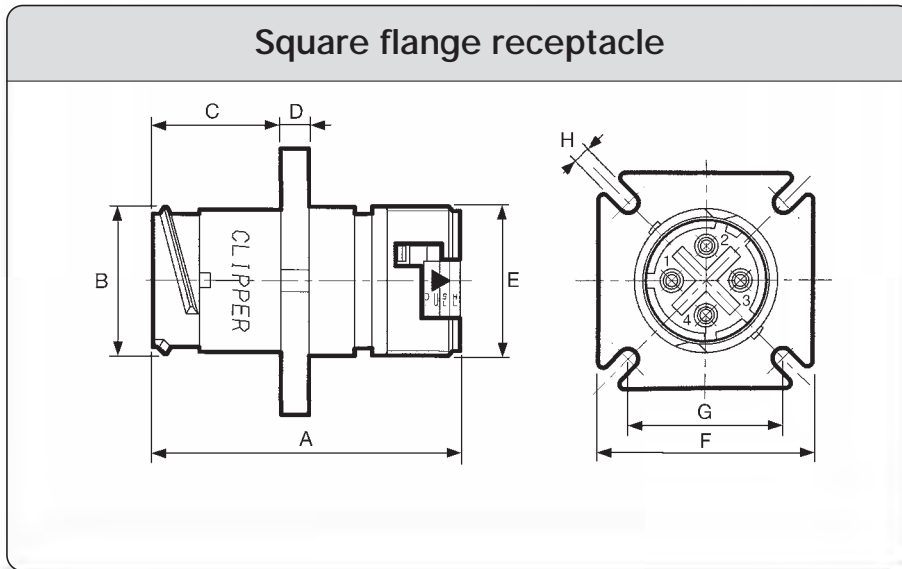

| Shell sizes | 1 | 2 | 3 | 4 |
|----------------------|------|------|------|------|
| Dim. (inches) | | | | |
| A | 1.67 | 1.67 | 1.67 | 1.67 |
| B | .83 | .96 | 1.14 | 1.59 |
| C | .71 | .71 | .71 | .71 |
| D | .16 | .16 | .16 | .16 |
| E | .81 | .94 | 1.12 | 1.57 |
| F | 1.17 | 1.23 | 1.42 | 1.89 |
| G min. | .83 | .96 | 1.11 | 1.43 |
| G Max. | .92 | .98 | 1.17 | 1.57 |
| H | .13 | .13 | .15 | .15 |

| Shell sizes | 1 | 2 | 3 | 4 |
|----------------------|------|------|------|------|
| Dim. (inches) | | | | |
| A | .8 | .8 | .8 | .8 |
| B | 1.15 | 1.28 | 1.46 | 1.92 |
| C | .81 | .94 | 1.12 | 1.57 |
| D | 1.52 | 1.56 | 1.56 | 1.56 |

Clipper Industrial Plastic Connectors



Manual Crimping Tool

Stamped and Formed Contacts (#16 and #20)

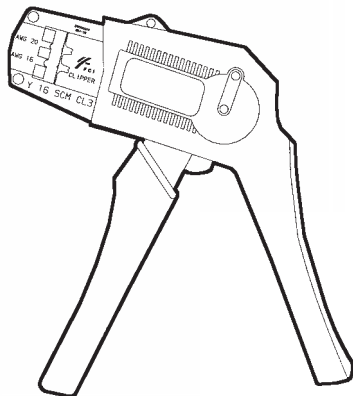

Y16SCMCL3

- Squeeze the plier handles until a final click sounds, release, the pliers should open by themselves.
- Fully insert the contact into the locator (corresponding gauge), the contact crimping lugs should be directed upwards, according to the drawing.
- Put the stripped wire in the crimping part until it comes in contact with the stopper plate. Make sure that no strands stick out of the crimping part.
- Squeeze the plier handles until a final click sounds, release, the pliers should open by themselves.
- Check the overall aspect of the crimping.

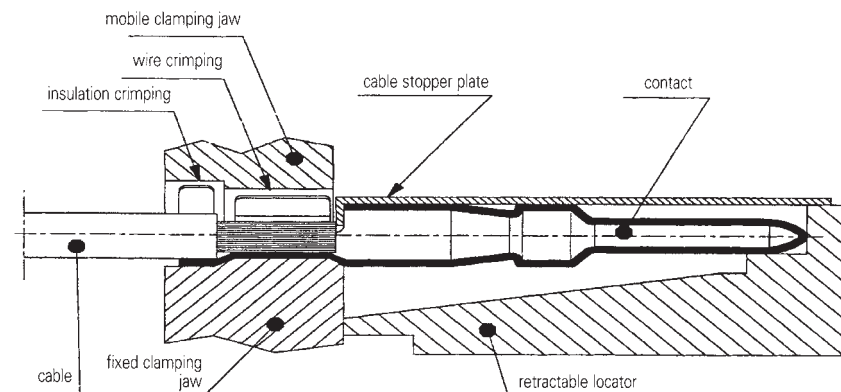

Machined Crimping Contacts (#16 and #20)

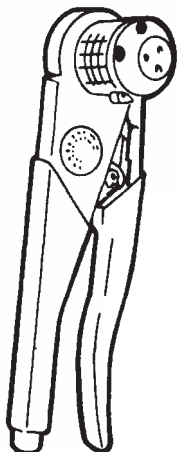

8365
with
locator
8365-02

- Push the cable into the contact barrel and make sure the cable strands stick out of the inspection hole.
- The pliers must be used on the jaws side.
- Squeeze the plier handles until a final click sounds, release, the pliers should open by themselves.
- Insert both wire and contact (or wire, reducing sleeve and contact) between the 4 jaws until stopped by the locator.
- Fully squeeze until a final click sounds, the pliers should open once the crimping is performed
- Extract the wire and crimped contact, then check the overall aspect of the crimping.

Clipper Industrial Plastic Connectors



Automatic crimping tool



UTM2 Automatic crimping tool for Clipper

Description

Electromechanical high speed semi automatic press is designed for mass production and is realized totally in assembled steel parts.

Voltage: 115VAC - 60 Hz
 Power.: 700 Watts
 Weight: 300 lbs. (including one crimp mechanism)
 Dimensions: 939.8x533.4x711.2 mm (37.0"x21.0"x28.0")

Crimping Mechanism (left side miniapplicators)

| Contacts | AWG | Contact P/N | Crimp Mech. P/N |
|----------|-------|------------------------------|-----------------|
| 16 | 16-18 | CF16 PS 18RF CF16 SC 18RF | CM30-R |
| 20 | 20-22 | CF10 PS 18RF CF10 SC 18RF | CM31-R |



Press and crimping mechanism are rental.
 Please contact Customer Service.

Clipper Industrial Plastic Connectors



Panel mounting / Panel cut-out

Panel mounting

There are two types of mounting possible: through the front or through the back of the panel.

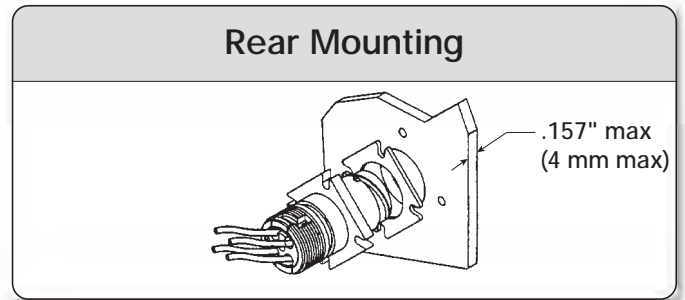
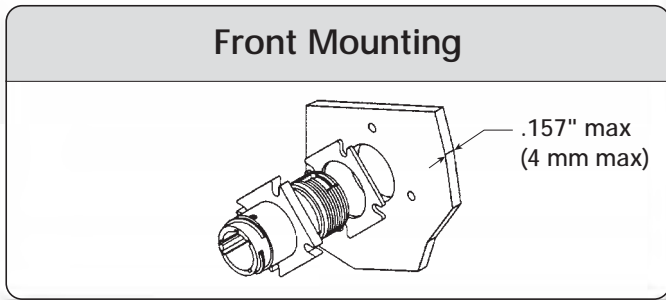

Panel cut-out

• For a sealed mounting, the seal gasket shall be used, making sure the surface is in good condition.

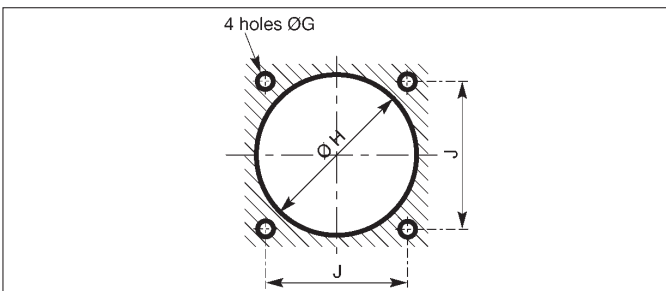

• Observe the drilling hole diameters indicated below.

- Use the recommended screws :
M3 (all shells)
or # 4.40 (shells 1 and 2)
6.32 (shells 3 and 4)

• Respect the coupling torques indicated M3
(all shells) : 0.70 N.m Max

| Shell sizes | 1 | 2 | 3 | 4 |
|---------------|-----|-----|------|------|
| Dim. (inches) | | | | |
| H | .85 | .98 | 1.22 | 1.61 |
| I | .84 | .97 | 1.13 | 1.44 |
| J | .13 | .13 | .15 | .15 |

Clipper Industrial Plastic Connectors



Wiring Instruction

Stripping Instructions

Use the upmost care with stripping operation :

- Use stripping pliers appropriate for the cable gauge and which are in perfect condition.
- In order to obtain a correct crimping and to maintain all of the connector sealing characteristics, the wires must have the dimensions described below.

Jacketed Cable Stripping Length

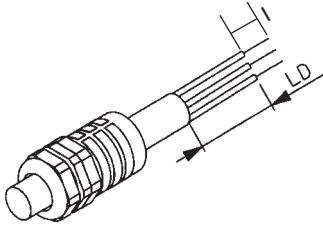

Make a 90° cut at the cable end.

carefully make an incision in order to remove the cable protection on a length LD as described.

| Shell size | 1 | 2 | 3 | 4 | |
|------------|-------------|---------|---------|---------|---------|
| layouts | Indifferent | | | 26 | 40 |
| LD mm | 60 | 65 | 65 | 80 | 100 |
| (inch) | (2.36') | (2.56') | (2.56') | (3.15") | (3.94") |

Caution : This operation should be realized without deterioration of wires insulation.

Then, follow the normal stripping instructions :

- single wire with machined crimping contacts,
- single wire with stamped and formed crimping contacts

Wire Stripping Length

- With machined crimping contacts

| Contact size | l = Wire stripping length |
|--------------|--|
| layouts | 6 mm (.236") |
| #20 | \varnothing over insulation > 2 mm \Rightarrow l = 5 (> .08" \Rightarrow l = .20") \varnothing over insulation > 2 mm \Rightarrow l = 7 (> .08" \Rightarrow l = .27") |

- With stamped and formed crimping contacts

| Contact diameter | l = Wire stripping length |
|------------------|---------------------------|
| #16 | 4 mm (.157") |
| #20 | 4 mm (.157") |



Instruction For Assembly

Insertion and extraction of contacts

Single wires

Contact insertion and extraction is performed without a tool thanks to the retainer plate system.

Insertion



1) With the thumb and index finger, squeeze the retainer plate flaps and pull backwards : the plate is then in the unlocked position.

2) Fully insert the wired contact in the cavity.



3) Repeat the same procedure for the other contacts.

4) Once again squeeze the retainer plate flaps and push forwards: the plate is then locked and retains the contacts (90 N of retention force for contacts of 1.6 mm dia.)



5) The plate can only be pushed back if the contacts are correctly engaged (backup security)

Extraction



1) With the thumb and index finger, squeeze the retainer plate flaps and pull backwards : the plate is then in the unlocked position.

2) Pull the contact wire: the contact comes out of the cavity.



3) Repeat the same procedure for the other contacts.

Special case of jacketed cables

- 1) Locate the first contact and the corresponding cavity.
- 2) The wire should be described as a buckle as described below.
- 3) Unlock the retainer plate as described above.
- 4) Fully insert the wired contact in the cavity.
- 5) Respect the same procedure for the other contacts
- 6) Once again squeeze the retainer plate flaps and push forwards : the plate is then locked

Special case of jacketed cables

- 7) Manually fully screw the adaptor and the backshell on the connector.

Caution : In the sealed version don't forget the O-ring.

- 8) Push forwards the cable of 10 mm in the backshell.
- 9) Fully screw on the backshell with a wrench while keeping the adaptor with another wrench.

Note : The plate can only be pushed back if the contacts are correctly engaged (backup- security)



Clipper Industrial Plastic Connectors



Instruction For Assembly

Adaptor and PG electrical thread backshells

The CLIPPER connector must be equipped with an adaptor in order to use a PG electrical thread backshell (e.g.: cable clamp or sealing gland, or flexible conduits system backshells, etc.)



- 1) Manually, fully screw the adaptor on the connector, the hexagonal nut towards the rear.
- 2) In the sealed version, cover the O-ring.
- 3) Manually, fully screw the PG thread backshell of your choice.



Note: In the case of an elbow backshell, it is possible to adjust the position according to the angle desired.

Heat shrink boot

Shrink sleeve as follows :

- 1) Use heat gun with an air deflector nozzle.
- 2) Adjust air deflector opening to accommodate tubing size. Turn switch ON. Wait until full heat output is reached.
- 3) Position the air deflector over section of tubing to be shrunk. Start at pre-shrunk section and work towards open end.
- 4) When tubing begins to shrink, move gun so that air is distributed in a band around the tubing circumference causing it to shrink evenly around the cable.
- 5) Move nozzle to adjacent section and shrink in the same manner. Repeat process on section at a time until entire length is shrunk.

Avoid excessive heat. Direct heat away from connector assembly to prevent damage.

Grommet Backshell Assembly

Grommet Thrust ring O ring

- 1) Position the O-ring at the bottom of the backnut.
- 2) Run the backnut around the cable.
- 3) Unlock the retainer plate.
- 4) Position the grommet in the thrust ring, resting against the retainer plate.
- 5) Insert the contacts through the grommet and the retainer plate.
- 6) Lock the retainer plate.
- 7) Screw the backshell.

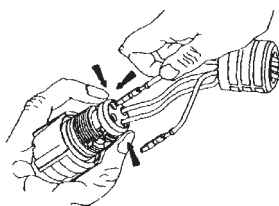

Instruction for polarizing connector mounting

CP16SW9700

When the insert is partially filled with contacts, place polarization contact into selected hole location in the FEMALE INSERT and push in until seated.

- Polarization contacts are used to provide keying capabilities for the CLIPPER series.
- Polarization contacts are used in the **socket-cavities** of standard plugs and reverse receptacles.

In order to lock the couple of chosen connectors, you have to let free the cavity in front of the polarization contact.

To avoid the connection with other connectors, you have to insert a contact in the cavity in front of the polarization contact.

Clipper Industrial Plastic Connectors



General technical information

Degree of protection in accordance with CEI 529, DIN 40050, NF EN 60529

| First index Protection against accidental or inadvertent contact. Prot. against ingress of foreign bodies. | | Second index Protection against ingress of water | | Third index Protection against mechanical strength | |
|---|---|--|--|---|---|
| Index | Test | 0 No protection | 2 Protection against diagonal drop water drips (up to <math>< 15^\circ</math> of vertical) | 0 No protection | Troisième chiffre |
| 0 | #0 No protection | #0 x 0 | | | |
| 1 | #1 Ball $\varnothing 2$ inch Protection against contact with any large area by hand, protect. against large solid foreign bodies with $\varnothing > 2$ inch. | 1 Protection against vertical drop water drips. #1 x 1 | | 1 | Impact strength : 0,225 J #1 x 1 |
| 2 | #2 Ball $\varnothing .5$ inch Test finger Protection against contact with the fingers, prot. against solid foreign bodies with $\varnothing 0.5$ inch | 3 Protection against diagonal drop water drips (up to <math>< 60^\circ</math> out of vertical) #3 x 3 | 4 Protection against splash water from all directions #4 x 4 | 3 | Impact strength : 0,5 J #3 x 3 |
| 3 | #3 Steel wire $\varnothing 0.1$ inch Protection against tools wires or similar objects with $\varnothing > 0.1$ inch, prot. against small foreign solid bodies with $\varnothing > 0.1$ inch | 5 Protection against water (out of a nozzle) from all directions #5 x 5 | | 5 | Impact strength : 2 J #5 x 5 |
| 4 | #4 Steel wire $\varnothing .04$ inch Protection against tools wires or similar objects with $\varnothing > .04$ inch, prot. against small foreign solid bodies with $\varnothing > .04$ inch | 6 Proof against temporary flooding #6 x 6 | | 7 | Impact strength : 6 J #7 x 7 |
| 5 | #5 Full protection against acid, or inadiv. contact. Prot. against interior injurious dust deposits. #6 Talc Total protection against acid, or inadiv. contact. Protection against of dust. | 7 Protection against water plunging Proof against temporary water plunging #7 x 7 | 8 Water tight W Proof against water pressure | 9 | Impact strength : 20 J #9 x 9 |

EXAMPLE : IP66-5 means: - Total protection against dust
- Proof against temporary flooding
- Proof against impact strength of 2 Joule

Clipper Industrial Plastic Connectors



Conversion Table

| (mm) | (inches) |
|------|----------|
| 0.1 | 0.00394 |
| 0.2 | 0.00788 |
| 0.3 | 0.01182 |
| 0.4 | 0.01576 |
| 0.5 | 0.01970 |
| 0.6 | 0.02364 |
| 0.7 | 0.02758 |
| 0.8 | 0.03152 |
| 0.9 | 0.03546 |
| 1.0 | 0.03940 |
| 1.1 | 0.04334 |
| 1.2 | 0.04728 |
| 1.3 | 0.05122 |
| 1.4 | 0.05516 |
| 1.5 | 0.05910 |
| 1.6 | 0.06304 |
| 1.7 | 0.06698 |
| 1.8 | 0.07092 |
| 1.9 | 0.07486 |
| 2.0 | 0.07880 |
| 2.1 | 0.08274 |
| 2.2 | 0.08668 |
| 2.3 | 0.09062 |
| 2.4 | 0.09456 |
| 2.5 | 0.09850 |
| 2.6 | 0.10244 |
| 2.7 | 0.10638 |
| 2.8 | 0.11032 |
| 2.9 | 0.11426 |
| 3.0 | 0.11820 |
| 3.1 | 0.12214 |
| 3.2 | 0.12608 |
| 3.3 | 0.13002 |
| 3.4 | 0.13396 |
| 3.5 | 0.13790 |
| 3.6 | 0.14184 |
| 3.7 | 0.14578 |
| 3.8 | 0.14972 |
| 3.9 | 0.15366 |
| 4.0 | 0.15760 |
| 4.1 | 0.16154 |
| 4.2 | 0.16548 |
| 4.3 | 0.16942 |
| 4.4 | 0.17336 |
| 4.5 | 0.17730 |
| 4.6 | 0.18124 |
| 4.7 | 0.18518 |
| 4.8 | 0.18912 |
| 4.9 | 0.19306 |
| 5.0 | 0.19700 |
| 5.2 | 0.20488 |
| 5.4 | 0.21276 |
| 5.6 | 0.22064 |
| 5.8 | 0.22852 |
| 6.0 | 0.23640 |
| 6.2 | 0.24428 |
| 6.4 | 0.25216 |
| 6.6 | 0.26004 |
| 6.8 | 0.26792 |
| 7.0 | 0.27580 |
| 7.2 | 0.28368 |
| 7.4 | 0.29156 |
| 7.6 | 0.29944 |
| 7.8 | 0.30732 |
| 8.0 | 0.31520 |

| (mm) | (inches) |
|------|----------|
| 8.2 | 0.32308 |
| 8.4 | 0.33096 |
| 8.6 | 0.33884 |
| 8.8 | 0.34672 |
| 9.0 | 0.35460 |
| 9.2 | 0.36248 |
| 9.4 | 0.37036 |
| 9.6 | 0.37824 |
| 9.8 | 0.38612 |
| 10.0 | 0.39400 |
| 10.5 | 0.41370 |
| 11.0 | 0.43340 |
| 11.5 | 0.45310 |
| 12.0 | 0.47280 |
| 12.5 | 0.49250 |
| 13.0 | 0.51220 |
| 13.5 | 0.53190 |
| 14.0 | 0.55160 |
| 14.5 | 0.57130 |
| 15.0 | 0.59100 |
| 15.5 | 0.61070 |
| 16.0 | 0.63040 |
| 16.5 | 0.65010 |
| 17.0 | 0.66980 |
| 17.5 | 0.68950 |
| 18.0 | 0.70920 |
| 18.5 | 0.72890 |
| 19.0 | 0.74860 |
| 19.5 | 0.76830 |
| 20.0 | 0.78800 |
| 20.5 | 0.80770 |
| 21.0 | 0.82740 |
| 21.5 | 0.84710 |
| 22.0 | 0.86680 |
| 22.5 | 0.88650 |
| 23.0 | 0.90620 |
| 23.5 | 0.92590 |
| 24.0 | 0.94560 |
| 24.5 | 0.96530 |
| 25.0 | 0.98500 |
| 25.5 | 1.00470 |
| 26.0 | 1.02440 |
| 26.5 | 1.04410 |
| 27.0 | 1.06380 |
| 27.5 | 1.08350 |
| 28.0 | 1.10320 |
| 28.5 | 1.12290 |
| 29.0 | 1.14260 |
| 29.5 | 1.16230 |
| 30.0 | 1.18200 |
| 30.5 | 1.20170 |
| 31.0 | 1.22140 |
| 31.5 | 1.24110 |
| 32.0 | 1.26080 |
| 32.5 | 1.28050 |
| 33.0 | 1.30020 |
| 33.5 | 1.31990 |
| 34.0 | 1.33960 |
| 34.5 | 1.35930 |
| 35.0 | 1.37900 |
| 35.5 | 1.39870 |
| 36.0 | 1.41840 |
| 36.5 | 1.43810 |
| 37.0 | 1.45780 |
| 37.5 | 1.47750 |

| (mm) | (inches) |
|--------|-----------|
| 38.0 | 1.49720 |
| 38.5 | 1.51690 |
| 39.0 | 1.53660 |
| 39.5 | 1.55630 |
| 40.0 | 1.57600 |
| 40.5 | 1.59570 |
| 41.0 | 1.61540 |
| 41.5 | 1.63510 |
| 42.0 | 1.65480 |
| 42.5 | 1.67450 |
| 43.0 | 1.69420 |
| 43.5 | 1.71390 |
| 44.0 | 1.73360 |
| 44.5 | 1.75330 |
| 45.0 | 1.77300 |
| 45.5 | 1.79270 |
| 46.0 | 1.81240 |
| 46.5 | 1.83210 |
| 47.0 | 1.85180 |
| 47.5 | 1.87150 |
| 48.0 | 1.89120 |
| 48.5 | 1.91090 |
| 49.0 | 1.93060 |
| 49.5 | 1.95030 |
| 50.0 | 1.97000 |
| 51.0 | 2.00940 |
| 52.0 | 2.04880 |
| 53.0 | 2.08820 |
| 54.0 | 2.12760 |
| 55.0 | 2.16700 |
| 56.0 | 2.20640 |
| 57.0 | 2.24580 |
| 58.0 | 2.28520 |
| 59.0 | 2.32460 |
| 60.0 | 2.36400 |
| 61.0 | 2.40340 |
| 62.0 | 2.44280 |
| 63.0 | 2.48220 |
| 64.0 | 2.52160 |
| 65.0 | 2.56100 |
| 66.0 | 2.60040 |
| 67.0 | 2.63980 |
| 68.0 | 2.67920 |
| 69.0 | 2.71860 |
| 70.0 | 2.75800 |
| 71.0 | 2.79740 |
| 72.0 | 2.83680 |
| 73.0 | 2.87620 |
| 74.0 | 2.91560 |
| 75.0 | 2.95500 |
| 80.0 | 3.15200 |
| 85.0 | 3.34900 |
| 90.0 | 3.54600 |
| 100.0 | 3.94000 |
| 200.0 | 7.88000 |
| 400.0 | 15.76000 |
| 600.0 | 23.64000 |
| 800.0 | 31.52000 |
| 1000.0 | 39.40000 |
| 1200.0 | 47.28000 |
| 1600.0 | 63.04000 |
| 2000.0 | 78.80000 |
| 3200.0 | 126.08000 |

| (°C) | (°F) |
|------|------|
| - 70 | - 94 |
| - 65 | - 85 |
| - 55 | - 67 |
| - 50 | - 58 |
| - 40 | - 40 |
| 0 | 32 |
| 37 | 98.6 |
| 80 | 176 |
| 125 | 257 |
| 150 | 302 |
| 170 | 338 |
| 200 | 392 |
| 250 | 482 |

| bar | psi | mmHg (torr) |
|-----|-------|-------------|
| 10 | 145.0 | 7600 |
| 5 | 72.5 | 3800 |
| 2 | 29.0 | 1520 |
| 1 | 14.5 | 760 |
| 0.5 | 7.2 | 380 |
| 0.1 | 1.4 | 76 |

| mbar | psi | torr (mmHg) |
|------|-------|-------------|
| 10 | 145.0 | 7600 |
| 5 | 72.5 | 3800 |
| 2 | 29.0 | 1520 |
| 1 | 14.5 | 760 |
| 0.5 | 7.2 | 380 |
| 0.1 | 1.4 | 76 |

- (1) 6145DJ - Câbles multipaires (armés, paires blindées) 250 MZH.
 (2) 6145DJ - Câbles multipaires (armés, paires non blindées) 250 MZH.

Clipper Industrial Plastic Connectors



Notes

Large grid area for notes.

SOURIAU

www.souriau-industrial.com

North America: technicalsupport@souriau.com
Europe and Asia: contactindustry@souriau.com

