

8D Series

MIL-DTL-38999 Series III



8D Series - Presentation

38999 Series III: 8D Series

Since the early 80's, Souriau is a major supplier of 38999 Series III, the screw-coupled version of MIL-C-38999. Present on the main international programs, Souriau has developed a range of products that meet the performance required in extreme environments:

- Civil and military aeronautics
- Ground military
- Industrial
- Marine and offshore

This evolution of MIL-C-38999 allows:

- A high contact density up to 128 contacts #22D
- A quick screw coupling with self locking mechanism
- High resistance to harsh environments (vibration, 200°C)

Always at the cutting edge of innovation, Souriau's teams have continuously improved this range of connectors:

- Composite version in the 90's (Its choice is recommended wherever weight is critical)
- Titanium version for weight saving and very high and mechanical resistance
- Today Souriau remains innovative with cadmium free and RoHS solutions.
In 2009 Souriau was the first to be QPL qualified for Zinc Nickel plating.

This product family is in accordance with MIL-DTL-38999 Series III, EN 3645, CECC (standard for bronze shell), ... and also meets many customers' standards (Rolls Royce, ABS, BACC, ...)

8D Series

MIL-DTL-38999 Series III



8D Series - Product overview

Standard Series

- ▶ 5 different materials
- ▶ A full platform that matches any environment
- ▶ Different platings (including RoHS & Cadmium free platings)

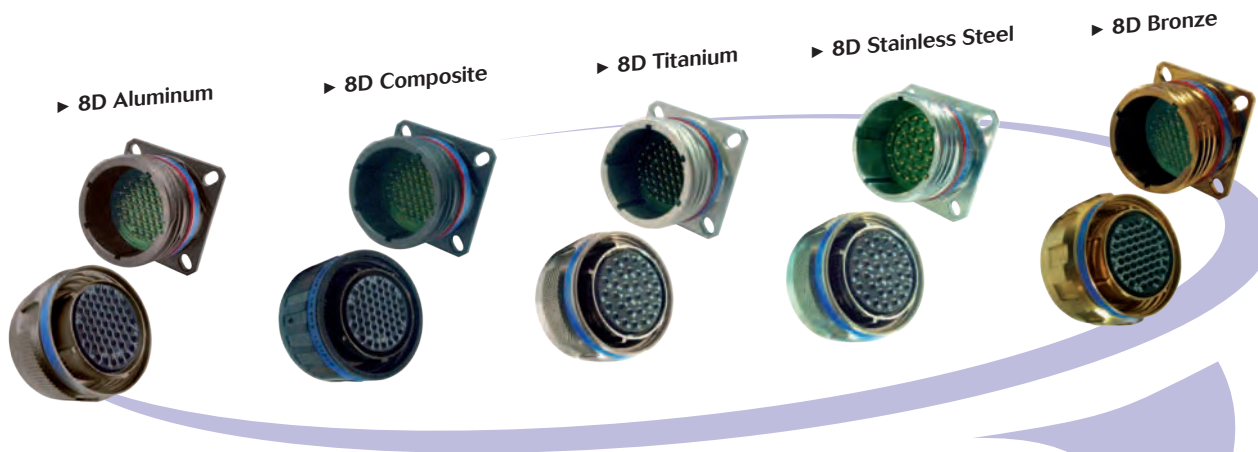

Derived Series

- ▶ Various possibilities of range extension & shell variant from Standard Series
- ▶ The only limit is your imagination: Consult us !

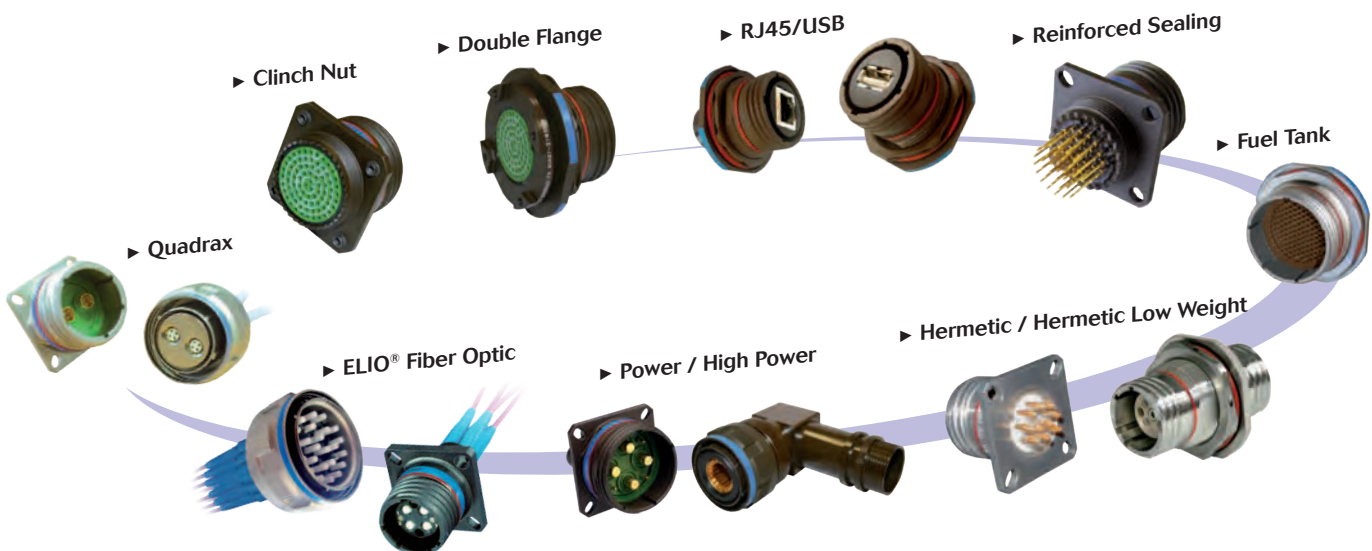

8D Series

MIL-DTL-38999 Series III



8D Series - A superior concept

A full range of contact

► Multi-contact technology provides versatile connectors

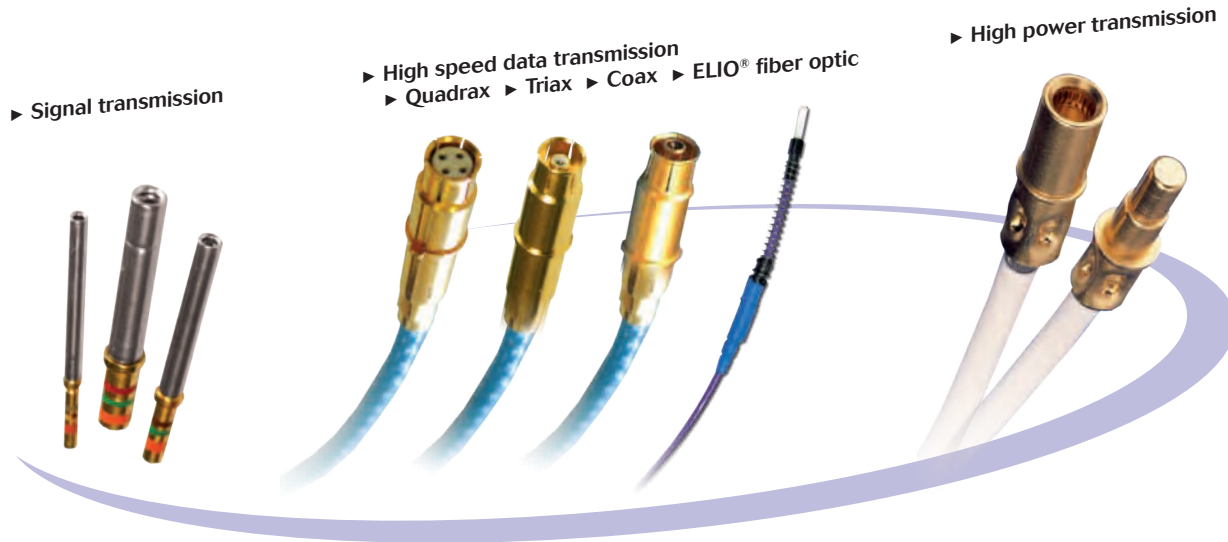

► Various contact styles

- Crimp
- Solder cup
- PC tails
- Wire wrap
- PCB contacts without shoulder

► Common cavity for all #8 contacts

Metal clips patented by Souriau

► Unique clip retention technology

► High performance contact retention system:

- Insure high temperature withstanding
- Provides superior strenght in vibrations
- Better retention characteristics than plastic clips

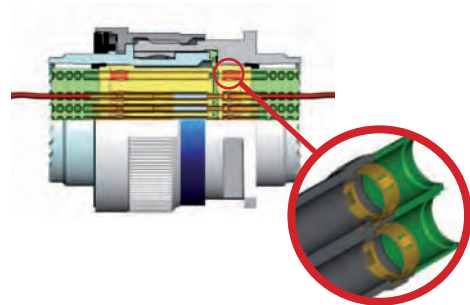

High performance sealing (IP67)

- Each contact cavity is individually sealed

Accessories available

- Protective caps, backshells, tools, ...

8D Series

MIL-DTL-38999 Series III



A performing MIL standard connector design

Scoop proof connector

- ▶ No risk of damaging the contact during the coupling operation

Unique self locking mechanism

- ▶ Connector will never unscrew even under high vibration (44g)

Visual mating indication

- ▶ Red band visible = not correctly mated



- ▶ Red band hidden = correctly mated



Quick screw coupling

- ▶ 1 1/4 turn to mate



Fully shielded connector

- ▶ 360° shielding



- ▶ Shell to shell bottoming = perfect shield continuity



8D Series

MIL-DTL-38999 Series III



Description

- High contact density
- Screw coupling
- Contact protection: 100% Scoop proof
- Shell size from 9 to 25
- Accessories available (protective caps, backshells, etc...)
- RFI - EMI shielding and shell to shell continuity
- Hermetic
- Protected by cadmium, nickel, green zinc cobalt or black zinc nickel plating

Applications

- Civil and Military Aerospace
- Marine and Offshore Equipment
- Defense and Ground Military
- Industrial

Standards

- MIL-DTL-38999 Series III
- EN3645
- BACC63CT/CU; BACC63DB/DC

Technical features

Mechanical

- **Shell:**
Aluminum, composite, stainless steel, bronze
- **Shells plating:**
 - . Aluminum shell:
 - Cadmium olive drab (W)
 - Nickel (F)
 - Black zinc nickel (Z)
 - Green zinc cobalt (ZO)
 - . Composite shell:
 - Cadmium olive drab (J)
 - Nickel (M)
 - Without plating (X)

- . Stainless steel shell:
 - Passivated (K)
 - Nickel (S)
 - . Titanium shell:
 - Without plating (TT)
 - Nickel (TF)
 - . Bronze shell:
 - Without plating
 - **Insulator:** Thermoplastic
 - **Grommet and interfacial seal:**
Silicone elastomer
 - **Contacts:** Copper alloy
 - **Contacts plating:** Gold over nickel plated
 - **Endurance:**
 - . 500 mating/unmating operations whatever the material used
 - . 1500 mating/unmating operations with composite connectors + specifics contacts
 - **Shock:**
300g, 3 ms according EN 2591-D2 method A
 - **Vibration:**
 - . Sinus:
 - . 10 à 2000 Hz, 3x12 hrs (60g, 140 - 2000 Hz) with T° cycling
 - . Random:
 - . 50 to 2000 Hz, 2x8 Hrs (1g2/ Hz, 100 - 2000Hz) at T° max.
 - . 25 to 2000 Hz, 2x8 Hrs (5g2/ Hz, 100 - 300Hz) at ambient T°
- Test with accessories in acc with EN2591-D3

• Contact retention:

Contacts size	22	20	16	12	8	4
Min force in N	44	67	111	111	111	200

Weight comparison

Example for a plug shell size 15

Materials	Weight	
Stainless steel	58.80 g	42% lighter
Titanium	33.90 g	
Aluminum	20.35 g	40% lighter
Composite	14.30 g	30% lighter



8D Series

MIL-DTL-38999 Series III

Electrical

• Test voltage rating (Vrms)

Service	sea level	at 21000 m
M	1 300	800
N	1 000	600
I	1 800	1 000
II	2 300	1 000

• Contact resistance

Contacts size	22	20	16	12	8	4
Resistance mΩ	14.6	7.3	3.8	3.5	3	2

• Insulation resistance:

≥ 5 000 MΩ (under 500 Vdc)

• Contact rating:

Contacts size	22	20	16	12	8	4
Rating (A)	5	7.5	13	23	45	80

• Shell continuity

- . Aluminum shell:
 - Cadmium olive drab (W): 2.5 Ω
 - Nickel (F): 1 Ω
 - Black zinc nickel (Z): 2.5 Ω
 - Green zinc cobalt (ZO): 2.5 Ω
- . Composite shell:
 - Cadmium olive drab (J): 3 Ω
 - Nickel (M): 3 Ω
- . Stainless steel shell:
 - Passivated (K): 10 Ω
 - Nickel (S): 1 Ω
- . Titanium shell:
 - Without plating (TT): 10 Ω
 - Nickel (TF): 1 Ω
- . Bronze shell:
 - Without plating: 5 Ω

• Shielding:

- . Aluminum shell:
 - F: 65 db at 10 GHz
 - F: 85 db at 1 GHz
 - W: 50 db at 10 GHz
 - Z & ZC: Consult us
- . Composite shell:
 - J: 90 db at 10 GHz
 - M: 85 db at 1 GHz
- . Stainless steel shell:
 - K: 45 db at 10 GHz
 - S: 65 db at 10 GHz
- . Titanium shell:
 - TT: 45 db at 10 GHz
 - TF: 65 db at 10 GHz
- . Bronze shell:
 - 85 db at 10 GHz

Climatics

• Temperature range:

- . Aluminum shell:
 - W: -65°C +175°C
 - F: -65°C +200°C
 - Z: -65°C +200°C
 - ZC: -65°C +175°C
- . Composite shell:
 - J: -65°C +175°C
 - M: -65°C +200°C
 - Without plating (X): -65°C +175°C
- . Stainless steel shell:
 - K: -65°C +200°C
 - S: -65°C +200°C
- . Titanium shell:
 - TT: -65°C +200°C
 - TF: -65°C +200°C
- . Bronze shell:
 - Without plating: -65°C +175°C

• Sealing:

Mated connectors meet altitude immersion requirements of MIL-DTL-38999.

• Salt spray:

- . Aluminum shell:
 - W: 500 Hrs
 - F: 48 Hrs
 - Z: 500 Hrs
 - ZC: 250 Hrs
- . Composite shell:
 - J: 2000 Hrs
 - M: 2000 Hrs
 - Without plating (X): 2000 Hrs
- . Stainless steel shell:
 - K: 500 Hrs
 - S: 48 Hrs
- . Titanium shell:
 - TT: 500 Hrs
 - TF: 48 Hrs
- . Bronze shell:
 - Without plating: 500 Hrs

Resistance to fluids

- **According to MIL-DTL-38999 standard**
 - . Gasoline: JP5 (OTAN F44)
 - . Mineral hydrolic fluid: MIL-H-5606 (OTAN H515)
 - . Synthetic hydraulic fluid: Skydrol 500 B4
- **LD4 (SAE AS 1241)**
 - . Mineral lubricating: MIL-L-7870A (OTAN 0142)
 - . Synthetic lubricating: MIL-L-23699 (OTAN 0156), MIL-L-7808
 - . Cleaning fluid: MIL-DTL-25769 diluted
 - . De-icing fluid: MIL-A-8243
 - . Extinguishing fluid: Chlorobrométhane
 - . Cooling fluid: Coolanol

8D Series

MIL-DTL-38999 Series III



Contact layouts

09 / A

01 1 Optical position	05 1#8 Quadrax	35 6#22D Service M	98 3#20 Service I
-------------------------------------	------------------------------	----------------------------------	---------------------------------

- Contact #22D
- Contact #20
- Contact #16
- Contact #12
- Contact #10
- Contact #8 Triax
- Contact #8 Power
- Contact #8 Quadrax
- Contact ELIO® (optical fiber)
- Contact #4 Power

11 / B

01 1#12 Service II all series excepted JVS	01 1#8 Coax Service I only for JVS	02 2#16 Service I	02 2 Optical positions	04 4#20 Service I	05 5#20 Service I	12 1#12 Service II only for JVS	22 4#22D Service M
35 13#22D Service M	80 1#8 Triax Service I	81 1#8 Quadrax	98 6#20 Service I	99 7#20 Service I			

13 / C

03 3#16 Service I	04 4#16 Service I	04 4 Optical positions	08 8#20 Service I	26 2#12 6#22D Service M	35 22#22D Service M	98 10#20 Service I
---------------------------------	---------------------------------	--------------------------------------	---------------------------------	---------------------------------------	-----------------------------------	----------------------------------

ELIO® fiber optic Ethernet Quadrax

8D Series

MIL-DTL-38999 Series III



Contact layouts

15 / D

05 5#16 Service II	15 1#16 14#20 Service I	18 18#20 Service I	19 19#20 Service I	35 37#22D Service M	97 4#16 8#20 Service I
-------------------------------------	---------------------------------------------	-------------------------------------	-------------------------------------	--------------------------------------	--------------------------------------------

17 / E

02 38#22D 1#8 Triax Service M	06 6#12 Service I	08 8#16 Service II	20 4#12 16#22D Service M	22 2#12 2#8 Triax Service M	26 26#20 Service I	35 55#22D Service M	75 2#8 Triax Service M	
80 2#12 2#8 Quadrax	81 38#22D 1#8 Quadrax	82 2#8 Quadrax	99 2#16 21#20 Service I					

19 / F

08 8 Optical positions	11 11#16 Service II	18 14#22D 4#8 Triax Service M	28 26#20 2#16 Service I	32 32#20 Service I	35 66#22D Service M	53* 53#22D	84 14#22D 4#8 Quadrax
-----------------------------------------	--------------------------------------	---------------------------------------------------	---------------------------------------------	-------------------------------------	--------------------------------------	--------------------------	----------------------------------------

ELIO® fiber optic
 Ethernet Quadrax
 * Pending layout





8D Series

MIL-DTL-38999 Series III

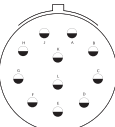
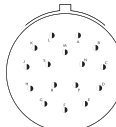
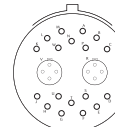
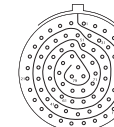

Contact layouts

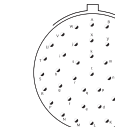
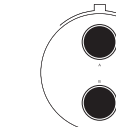
21 / G

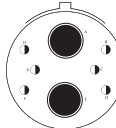
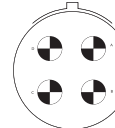
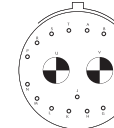
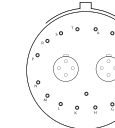
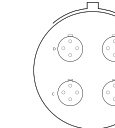
<p>11</p>  <p>11#12 Service I</p>	<p>16</p>  <p>16#16 Service II</p>	<p>20*</p>  <p>18#20 2#8 Quadrax</p>	<p>35</p>  <p>79#22D Service M</p>	<p>39</p>  <p>2#16 37#20 Service I</p>	<p>41</p>  <p>41#20 Service I</p>	<p>42</p>  <p>2#4 Power Service I</p>	<p>48</p>  <p>4#8 Power Service I</p>
<p>59</p>  <p>55#22D 4#12 Service M</p>	<p>72</p>  <p>2#4 Power 6#16 Service I</p>	<p>75</p>  <p>4#8 Triax Service M</p>	<p>77</p>  <p>17#22D 2#8 Coax Service M</p>	<p>78</p>  <p>17#22D 2#8 Quadrax</p>	<p>84</p>  <p>4#8 Quadrax</p>		

23 / H

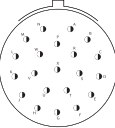
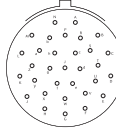
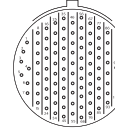
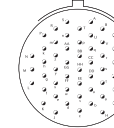
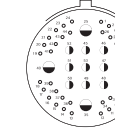
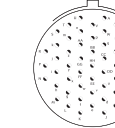
<p>21</p>  <p>21#16 Service II</p>	<p>32</p>  <p>32#20 Service I</p>	<p>35</p>  <p>100#22D Service M</p>	<p>53</p>  <p>53#20 Service I</p>	<p>54</p>  <p>4#12, 9#16 40#22D Service M</p>	<p>55</p>  <p>55#20 Service I</p>
----------------------------------------------------------------------------------------------------------------------------------	---------------------------------------------------------------------------------------------------------------------------------	-----------------------------------------------------------------------------------------------------------------------------------	---------------------------------------------------------------------------------------------------------------------------------	-------------------------------------------------------------------------------------------------------------------------------------------------	----------------------------------------------------------------------------------------------------------------------------------

8D Series

MIL-DTL-38999 Series III



Contact layouts

25 / J							
<p>04</p> <p>8#16 48#20 Service I</p>	<p>07</p> <p>2#8 Triax 97#22D Service M</p>	<p>08</p> <p>8#8 Triax Service M</p>	<p>11</p> <p>2#20 9#10 Service N</p>	<p>17</p> <p>36#22D 6#8 Triax</p>	<p>19</p> <p>19#12 Service I</p>	<p>20*</p> <p>10#20, 13#16 4#12 Coax 3#8 Triax Service N</p>	<p>24</p> <p>12#16 12#12 Service II</p>
<p>24</p> <p>24 Optical positions</p>	<p>29</p> <p>29#16 Service I</p>	<p>35</p> <p>128#22D Service M</p>	<p>37</p> <p>37#16 Service I</p>	<p>41</p> <p>22#22D, 3#20 11#16, 2#12 3#8 Triax Service M</p>	<p>43</p> <p>23#20 20#16 Service I</p>	<p>44</p> <p>4#4 Power 4#16 Service I</p>	<p>46</p> <p>40#20, 4#16 2#8 Coax Service I</p>
<p>61</p> <p>61#20 Service I</p>	<p>80</p> <p>10#20 13#16 4#12 Coax 3#8 Quadrax</p>	<p>81</p> <p>22#22D 3#20, 11#16 2#12 3#8 Quadrax</p>	<p>82</p> <p>97#22D 2#8 Quadrax</p>	<p>86</p> <p>40#20 4#16 2#8 Quadrax</p>	<p>87</p> <p>36#22D 6#8 Quadrax</p>	<p>88</p> <p>8#8 Quadrax</p>	<p>90</p> <p>40#20, 4#16 2#8 Twinax Service I</p>



8D Series

MIL-DTL-38999 Series III



Contact layouts (matrix)

Shell size	Layout	MIL-DTL-38999 (QPL) Aluminum, Stainless steel & Composite	8D Titanium	JVS (CECC) Bronze connectors	Hermetics	EN3645	BACC63 CT/CI DB/DC	Number of contacts	#22D	#20	#16	#12	#10	#8	#4 Power	Optical posi- tions
09 / A	09-01							1								1
	09-05 (1)	Consult us	Consult us	Consult us				1						1 Qdx		
	09-35							6	6							
	09-98							3		3						
11 / B	11-01							1				1				
	11-01							1						1 Coax		
	11-02							2			2					
	11-02							2								2
	11-04							4		4						
	11-05							5		5						
	11-12							1				1				
	11-22							4	4							
	11-35							13	13							
	11-80							1						1 Triax		
	11-81							1						1 Qdx		
11-98							6		6							
11-99							7		7							
13 / C	13-03							3								
	13-04							4			4					
	13-04							4								4
	13-08							8		8						
	13-26							8	6			2				
	13-35							22	22							
13-98							10		10							
15 / D	15-05							5			5					
	15-15							15		14	1					
	15-18							18		18						
	15-19							19		19						
	15-35							37	37							
	15-97							12		8	4					
17 / E	17-02							39	38					1 Triax		
	17-06							6				6				
	17-08							8			8					
	17-20							20	16			4				
	17-22							4				2		2 Triax		
	17-26							26		26						
	17-35							55	55							
	17-75							2						2 Triax		
	17-80							4				2		2 Qdx		
	17-81							39	38					1 Qdx		
17-82							2						2 Qdx			
17-99							23		21	2						
19 / F	19-08							8								8
	19-11							11			11					
	19-18							18	14					4 Triax		
	19-28							28		26	2					
	19-32							32		32						
	19-35							66	66							
	19-53							53	53							
19-84							18	14					4 Qdx			

 Souriau's layout
 Souriau's layout & Layout according to corresponding norm
 (1) Grounded insert only
 #8 Pow: Power; Qdx: Quadrax; Twx: Twinax

8D Series

MIL-DTL-38999 Series III



Contact layouts (matrix)

Shell size	Layout	MIL-DTL-38999 (QPL) Aluminum, Stainless steel & Composite	8D Titanium	JVS (CECC) Bronze connectors	Hermetics	EN3645	BACC63 CT/CI DB/DC	Number of contacts	#22D	#20	#16	#12	#10	#8	#4 Power	Optical posi- tions	
21 / G	21-11							11				11					
	21-16							16			16						
	21-20							20		18					2 Qdx		
	21-35							79	79								
	21-39							39		37	2						
	21-41							41		41							
	21-42							2							2		
	21-48							4							4 Pow		
	21-59							59	55				4				
	21-72							8							2		
	21-75							4							4 Triax		
	21-77							19	17						2 Coax		
21-78							19	17						2 Qdx			
21-84							4							4 Qdx			
23 / H	23-21							21			21						
	23-32							32		32							
	23-35							100	100								
	23-53							53		53							
	23-54							53	40		9	4					
	23-55							55		55							
25 / J	25-04							56		48	8						
	25-07							99	97						2 Triax		
	25-08			(2)				8							8 Triax		
	25-11							11		2			9				
	25-17							42	36						6 Triax		
	25-19							19				19					
	25-20	(3)		(4)		(5)	(6)	30		10	13	4			3 Triax		
	25-24							24			12	12					
	25-24							24								24	
	25-29							29			29						
	25-35							128	128								
	25-37							37			37						
	25-41							41	22	3	11	2			3 Triax		
	25-43							43		23	20						
	25-44							8			4				4		
	25-46							46		40	4				2 Coax		
	25-61							61		61							
	25-80							30			10	13	4		3 Qdx		
25-81							41	22	3	11	2			3 Qdx			
25-82							99	97						2 Qdx			
25-86							46		40	4				2 Qdx			
25-87							42	36						6 Qdx			
25-88							8							8 Qdx			
25-90							46		40	4				2 Twx			

- Souriau's layout
- Souriau's layout & Layout according to corresponding norm
- (2) For CECC, layout 25-08 only delivered without contact
- (3) For Aluminum & Stainless steel only
- (4) For classes F, W, S, K only
- (5) For classes F, W, K only
- (6) Qualified BACC63DB/DC only
- #8 Pow: Power; Qdx: Quadrax; Twx: Twinax



8D Series

D38999 Aluminum Series

Connector part numbers

Basic Series	8D	0	-	11	W	35	P	N	-	-	L
Shell style:											
<ul style="list-style-type: none"> 0: Square flange receptacle 1: In line receptacle 7: Jam nut receptacle 5: Plug with RFI shielding 											
<i>Also available:</i>											
<ul style="list-style-type: none"> . Square flange receptacle with clinch nuts (see page 80) . Jam nut receptacle with double flange (see page 83) 											
Type:											
<ul style="list-style-type: none"> None: Connectors with standard crimp contacts. L: Receptacle with long PC tail (male and female size #22D, #20). C: Receptacle with short PC tail (male and female #22D, #20, #16). S: Receptacle with specific PC tail (male et female #22D) W: Receptacle with male contacts #22D for wire wrap (3 wraps) T: Receptacle with male contacts #20 for wire wrap (2 wraps) P: Receptacle with solder cup - only available for Reinforced sealing Series (see page 75) - male and female size #22D; male #16 & #12; female #16 & #12 and male female #20 please consult us 											
Shell size: 09, 11, 13, 15, 17, 19, 21, 23, 25											
Plating:											
<ul style="list-style-type: none"> W: Olive drab cadmium F: Nickel ZC: Green zinc cobalt Z: Black zinc nickel 											
Contact layout: See pages 13 to 16											
Contact type:											
<ul style="list-style-type: none"> P: Pin A: Connector supplied less pin contact or with specific contacts (connector marking: A + orientation) S: Socket B: Connector supplied less socket contact or with specific contacts (connector marking: B + orientation) 											
Orientation: N, A, B, C, D, E (see page 64)											
Specification:											
<ul style="list-style-type: none"> 046: Tinned straight PC tail 251: Connector provided with power contacts (layouts with contact #8) 022: Fuel tank 											
Special custom:											
<ul style="list-style-type: none"> None: Standard plastic cap M: Antistatic plastic cap L: For P or S contact type only, connectors delivered without contacts, connectors marking P or S plus orientation 											



8D Series

D38999 Aluminum Series

MIL-DTL-38999 part numbers*

Basic Series	D38999/	20	W	B	35	P	N	L
Shell style:								
20: Square flange receptacle								
24: Jam nut receptacle								
26: Plug with RFI shielding.								
Plating:								
Z: Black zinc nickel								
W: Olive drab cadmium								
F: Nickel								
Shell size: A, B, C, D, E, F, G, H, J								
Contact layout: See page 17 for layout according to MIL-DTL-38999								
Contact type:								
P: Pin								
A: Connector supplied less pin contact or with specific contacts (connector marking: A + orientation)								
S: Socket								
B: Connector supplied less socket contact or with specific contacts (connector marking: B + orientation)								
Orientation: N, A, B, C, D, E (see page 64)								
L: For P or S contact type only, connector delivered without contacts, connector marking P or S (without L)								

* Note: To place an order of MIL connectors delivered without MIL removable crimp contacts and keep P or S plus orientation marking, it must be specify clearly on the order (by adding a suffix L at the end of the P/N or specified in comment).

EN3645 part numbers

Basic Series	EN3645	W	6	G	N	35	B	N
Plating:								
W: Olive drab cadmium								
F: Nickel								
Shell style:								
0: Square flange receptacle								
6: Plug								
7: Jam nut receptacle								
Shell size:								
09=A, 11=B, 13=C, 15=D, 17=E, 19=F, 21=G, 23=H, 25=J								
Grounding:								
N: Standard insert not grounded								
Contact layout:								
See page 17 for layout according to EN3645								
Contact type:								
A: Connector supplied less pin contact								
B: Connector supplied less socket contact								
F: Socket								
M: Pin								
Orientation:								
N, A, B, C, D, E (see page 64)								

8D Series

D38999 Aluminum Series



Dimensions

Receptacle type 0

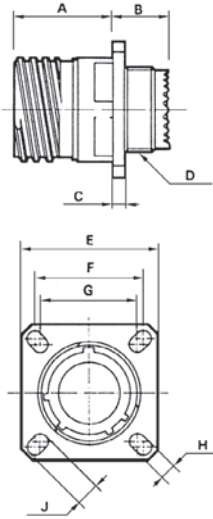

Shell size	A Max	B Max	C Max	D Thread	E ± 0.3	F	G	H ± 0.2	J ± 0.2
09 (A)	20.9	10.72	2.5	M12 x 1-6g	23.8	18.26	15.09	3.25	5.49
11 (B)				M15 x 1-6g	26.2	20.62	18.26		4.93
13 (C)				M18 x 1-6g	28.6	23.01	20.62		4.4
15 (D)				M22 x 1-6g	31	24.61	23.01		4.93
17 (E)				M25 x 1-6g	33.3	26.97	24.61		
19 (F)	20.1	11.54	3.2	M28 x 1-6g	36.5	29.36	26.97	3.91	6.15
21 (G)				M31 x 1-6g	39.7	31.75	29.36		
23 (H)				M34 x 1-6g	42.9	34.93	31.75		
25 (J)				M37 x 1-6g	46	38.1	34.93		

Receptacle type 7

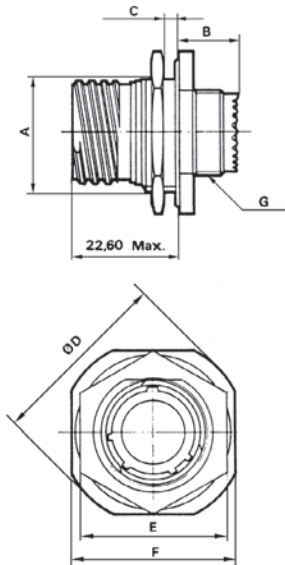

Shell size	A ± 0.15	B Max	C Max	D Max	E Max	F ± 0.4	G Thread
09 (A)	16.53	9.9	3.2	30.5	23	27	M12 x 1-6g
11 (B)	19.07			35.2	26	31.8	M15 x 1-6g
13 (C)	23.82			38.4	31	34.9	M18 x 1-6g
15 (D)	26.97			41.6	34	38.1	M22 x 1-6g
17 (E)	30.15			44.8	37	41.3	M25 x 1-6g
19 (F)	33.32			49.5	41	46	M28 x 1-6g
21 (G)	36.50			52.7	46	49.2	M31 x 1-6g
23 (H)	39.67			55.9	47	52.4	M34 x 1-6g
25 (J)	42.85			59	51.23	55.6	M37 x 1-6g

Recommended coupling torque on panel for jam nut receptacle (type 7)

Shell	09 (A)	11 (B)	13 (C)	15 (D)	17 (E)	19 (F)	21 (G)	23 (H)	25 (J)
Coupling torque (± 0.5 N.m)	4	5	7	8	9	10	12	13	14

Note: All dimensions are in millimeters (mm)

8D Series

D38999 Aluminum Series



In line receptacle type 1

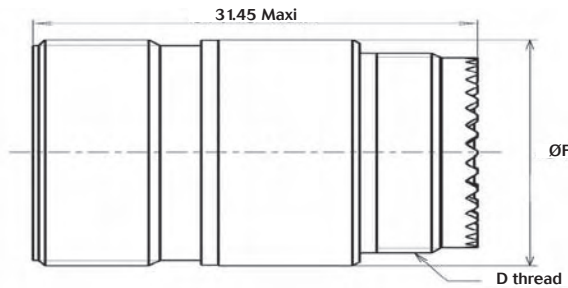

Shell size	D thread	Ø F
09 (A)	M12 x 1 6g	15.90
11 (B)	M15 x 1 6g	19.05
13 (C)	M18 x 1 6g	22.25
15 (D)	M22 x 1 6g	25.40
17 (E)	M25 x 1 6g	30.15
19 (F)	M28 x 1 6g	31.75
21 (G)	M31 x 1 6g	34.75
23 (H)	M34 x 1 6g	37.10
25 (J)	M37 x 1 6g	41.30

Plug type 5

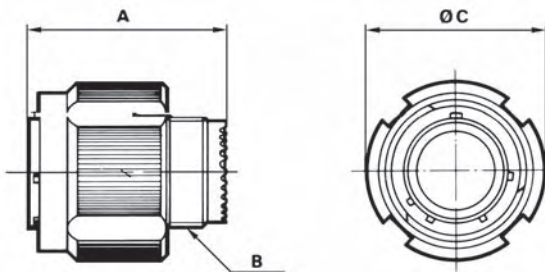

Shell size	A Max	B thread	C Max.
09 (A)	3 .0	M12 x g	21 80
11 (B)	3 .0	M15 x g	25 0
13 (C)	31.00	M18 x 1 6g	29 40
15 (D)	31.00	M22 x 1 6g	32 50
17 (E)	31.00	M25 x 1 6g	35 70
19 (F)	31.00	M28 x 1 6g	38.50
21 (G)	31.00	M31 x 1 6g	41.70
23 (H)	31.00	M34 x 1 6g	44.90
25 (J)	31.00	M37 x 1 6g	48.00

Mated connectors dimensions

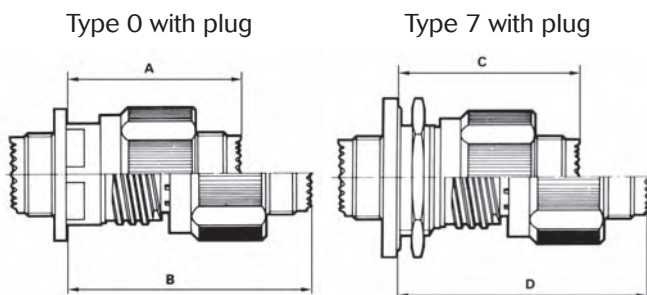

Shell size	A Max.	B Max.	C Max.	D Max.
09 (A)	37.00	52.30	38.30	53.60
11 (B)	37.00	52.30	38.30	53.60
13 (C)	37.00	52.30	38.50	53.80
15 (D)	37.00	52.30	38.50	53.80
17 (E)	37.00	52.30	38.50	53.80
19 (F)	37.00	52.30	38.50	53.80
21 (G)	36.00	51.30	38.50	53.80
23 (H)	36.00	51.30	38.50	53.80
25 (J)	36.00	51.30	38.50	53.80

Note: All dimensions are in millimeters (mm)

8D Series

D38999 Aluminum Series



Receptacle with straight PC tail contacts

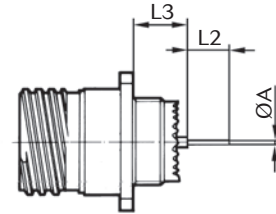
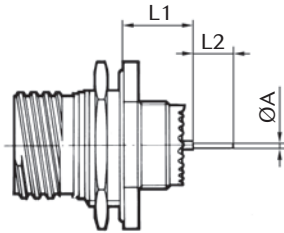

		Shell size			09 (A)	11 (B)	13 (C)	15 (C)	17 (E)	19 (F)	21 (G)	23 (H)	25 (J)
		Contact size	Contact type	PC tail type									
A		#22D	M & F	L & C	0.70								
		#22D	M & F	S	0.50								
		#20	M & F	C	0.70								
		#16	M & F	C	1.15								
L1	Min	#22D	M	L & C	10.52	10.34							
	Max	#22D	M	L & C	11.46	11.28							
	Min	#22D	F	L & C	10.19	10.01							
	Max	#22D	F	L & C	11.46	11.28							
	Min	#22D	M	S	10.19	10.01							
	Max	#22D	M	S	11.46	11.28							
	Min	#22D	F	S	10.69	10.51							
	Max	#22D	F	S	11.63	11.45							
	Min	#20	M	C	10.36	10.18							
	Max	#20	M	C	11.63	11.45							
	Min	#20	F	C	10.69	10.51							
	Max	#20	F	C	11.63	11.45							
	Min	#16	M	C	10.69	10.51							
	Max	#16	M	C	11.63	11.45							
	Min	#16	F	C	10.69	10.51							
	Max	#16	F	C	11.63	11.45							
L2		#22D	M & F	L	8.50								
		#22D	M & F	C	4.00								
		#22D	M & F	S	5.10								
		#20	M & F	C	5.10								
		#16	M & F	C	5.10								
L3	Min	#22D	M	L & C	9.48							9.59	
	Max	#22D	M	L & C	10.58							10.69	
	Min	#22D	F	L & C	9.15							9.26	
	Max	#22D	F	L & C	10.58							10.69	
	Min	#22D	M	S	9.65							9.76	
	Max	#22D	M	S	10.75							10.86	
	Min	#22D	F	S	9.15							9.26	
	Max	#22D	F	S	10.75							10.86	
	Min	#20	M	C	9.65							9.76	
	Max	#20	M	C	10.75							10.86	
	Min	#20	F	C	9.65							9.76	
	Max	#20	F	C	10.75							10.86	
	Min	#16	M	C	9.65							9.76	
	Max	#16	M	C	10.75							10.86	
	Min	#16	F	C	9.65							9.76	
	Max	#16	F	C	10.75							10.86	

M: Male contact F: Female contact L: Long PC tail C: Short PC tail S: Specific PC tail *Dimensions in millimeters*



8D Series

D38999 Aluminum Series

Souriau backshells part numbers

Basic Series								8D	102	B	02
Shell style:											
09	11	13	15	17	19	21	23	25			
101	102	103	104	105	106	107	108	109			
Plating:											
B: Olive drab cadmium											
F: Nickel											
Backshell type:											
01: Back nut (please consult us)											
02: Straight cable clamp											
03: 90° cable clamp											
13: Backshell for heat shrink boots											

Cross reference table

Backshell type	AS85049 Standard	Souriau Part Numbers
Back nut	M85049/14-**-x	8D101x01
Straight cable clamp	M85049/38-**-x	8D101x02
90° cable clamp	M85049/39-**-x	8D101x03
Backshell for heat shrink boots	M85049/69-**-x	8D101x13
Backshell for screen termination and cable clamp	M85049/19-**-x	N/A

x: Plating **: Shell size: see pages 13 to 16

8D Series

D38999 Aluminum Series



Backshells - Cable clamp

Straight cable clamp (Type 38)

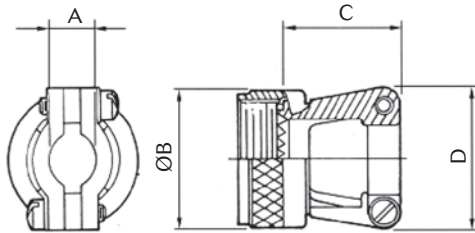

90° cable clamp (Type 39)

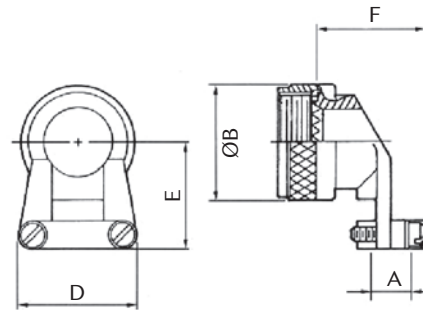

Shell size	A		ØB Max	C Max	D Max	E	F
	Min	Max					
09	2.50	5.90	21.80	23.10	21.60	25.40	25.70
11	3.90	5.90	25.00	23.10	22.90	27.90	25.70
13	4.80	8.30	29.40	25.70	27.90	27.90	30.70
15	6.60	11.60	32.50	26.90	29.20	31.80	32.00
17	7.20	15.60	35.70	29.50	33.00	33.00	35.80
19	8.30	16.10	38.50	35.80	38.10	34.30	38.40
21	8.70	17.70	41.70	38.40	40.60	40.60	42.20
23	9.70	20.90	44.90	42.20	43.20	44.50	44.70
25	10.60	21.70	48.00	44.70	45.70	47.00	48.50

Basic Series	M85049	38	-	11	W
Backshell type:					
38: Straight cable clamp					
39: 90° cable clamp					
Nut type:					
-: Without self-locking					
S: With self-locking					
Shell size:					
09, 11, 13, 15, 17, 19, 21, 23, 25					
Plating:					
Type 38 & 39:					
A: Black anodized (500 hours salt spray)					
W: Olive drab cadmium over nickel (500 hours salt spray)					
Type 38S & 39S:					
W: Olive drab cadmium over nickel (500 hours salt spray)					
N: Nickel (48 hours salt spray)					

Note: All dimensions are in millimeters (mm)

8D Series

D38999 Aluminum Series



Backshell for screen termination and cable clamp

Backshell for screen termination and cable clamp (Type 19)

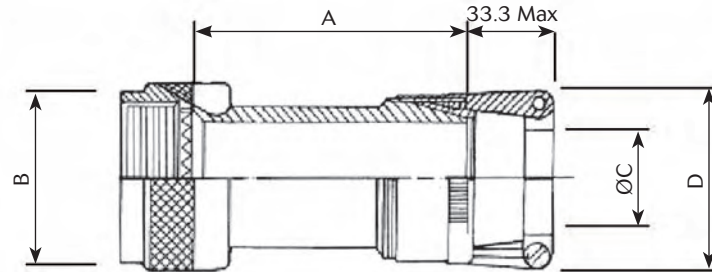

Shell size	A Max	B Max	Clamp indicator base on shell size
09	38.10	19.10	01 - 02
11		21.60	01 - 02 - 03
13		25.40	02 - 03 - 04
15		27.90	02 - 03 - 04 - 05
17		31.80	02 - 03 - 04 - 05 - 06
19		35.60	03 - 04 - 05 - 06 - 07
21		38.10	03 - 04 - 05 - 06 - 07 - 08
23		41.90	03 - 04 - 05 - 06 - 07 - 08
25		44.50	04 - 05 - 06 - 07 - 08 - 10

Clamp size indicator	C		D
	Min	Max	
01	1.60	3.20	20.30
02	3.20	6.35	25.40
03	6.35	9.50	27.90
04	7.90	12.70	30.50
05	11.10	15.90	31.80
06	14.30	19.00	35.60
07	17.45	22.20	38.10
08	20.60	24.40	41.90
09	23.80	28.60	44.50
10	27.00	31.75	48.30

Basic Series M85049 19 11 W 03

Shell style:
19: Backshell for screen termination and cable clamp

Shell size:
09, 11, 13, 15, 17, 19, 21, 23, 25

Plating:
W: Olive drab cadmium
N: Nickel

Clamp size indicator:
See tables above

8D Series

D38999 Aluminum Series



Backshells for heat shrink boots

Backshell for heat shrink boots (Type 69)

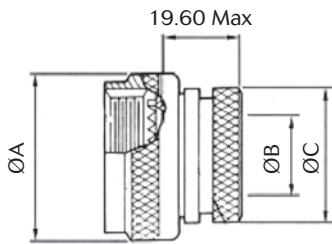

Shell size	ØA Max	ØB Max	ØC Max
09	19.10	6.35	13.55
11	21.60	9.50	15.40
13	25.40	12.70	19.70
15	29.20	15.90	21.30
17	31.80	19.00	24.50
19	35.60	20.60	26.50
21	39.40	23.80	30.90
23	41.90	27.00	34.40
25	47.00	30.20	36.65

Straight backshell for EMI/RFI heat shrink boots (Type 88)

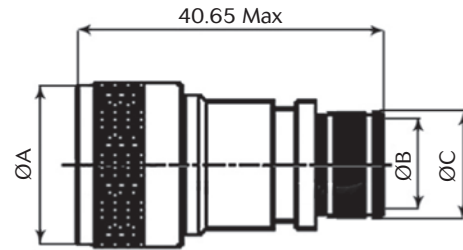

Shell size	ØA Max	ØB ^{±0.10} Entry size		ØC	
		02	03	02	03
09	21.79	-	6.35	-	10.03
11	24.99	-	7.92	-	11.61
13	29.39	7.92	11.13	11.61	14.81
15	32.49	11.13	14.27	14.81	17.96
17	35.71	12.70	15.88	16.38	19.56
19	38.51	15.88	19.05	19.56	22.73
21	41.71	15.88	20.62	19.56	24.30
23	44.91	17.47	23.83	21.06	27.51
25	47.98	19.05	25.40	22.73	29.08

Basic Series

M85049

69

11

A

D

Backshell type:

69: Backshell for heat shrink boots

88: Straight backshell for heat shrink boots

Shell size:

09, 11, 13, 15, 17, 19, 21, 23, 25

Plating:

Type 69:

A: Black anodised (500 hours salt spray)

Type 88:

W: Olive drab cadmium

N: Nickel

Option (Type 69 only):

Empty: Without drain hole

D: With drain hole

Entry size (Type 88 only):

02: See table above

03: See table above

8D Series

D38999 Aluminum Series



Dummy receptacle

Dimensions

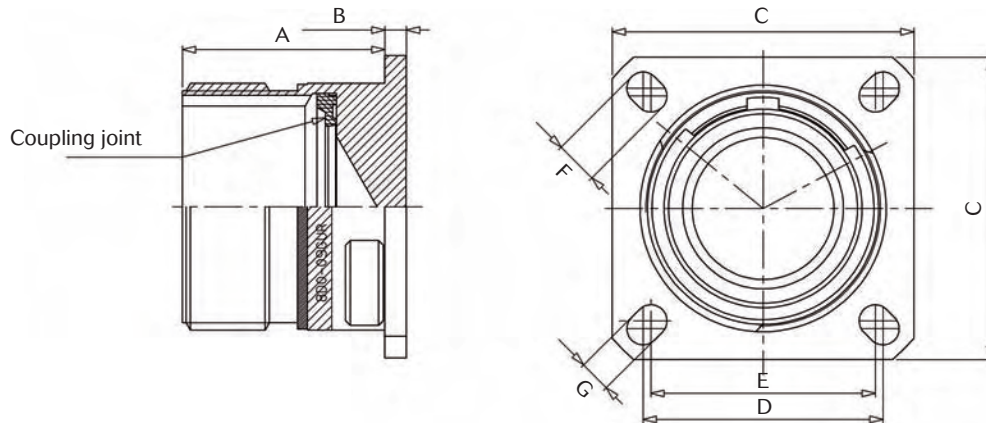

Shell size	Souriau Part number *	A Max	B Max	C ± 0.30	D	E	F ± 0.20	G ± 0.20
09	8D0-09GUR 8D0-09FUR	20.90	2.50	23.80	18.26	15.09	4.49	3.25
11	8D0-11GUR 8D0-11FUR	20.90	2.50	26.20	20.62	18.26	4.93	3.25
13	8D0-13GUR 8D0-13FUR	20.90	2.50	28.60	23.01	20.62	4.93	3.25
15	8D0-15GUR 8D0-15FUR	20.90	2.50	31.00	24.61	23.01	4.93	3.25
17	8D0-17GUR 8D0-17FUR	20.90	2.50	33.30	26.97	24.61	4.93	3.25
19	8D0-19GUR 8D0-19FUR	20.90	2.50	36.50	26.97	24.61	4.93	3.25
21	8D0-21GUR 8D0-21FUR	20.10	3.20	39.70	31.75	29.36	4.93	3.25
23	8D0-23GUR 8D0-23FUR	20.10	3.20	42.90	34.93	31.75	6.15	3.91
25	8D0-25GUR 8D0-25FUR	20.10	3.20	46.00	38.10	34.93	6.15	3.91

* G: Olive green cadmium
F: Nickel

8D Series

D38999 Aluminum Series



Caps

Caps for receptacle (D38999/33 - S2453)

With rope and eyelet

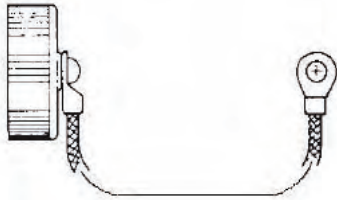

With rope and ring

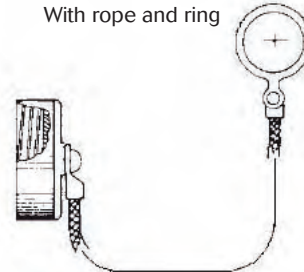

Shell size	Part numbers	
	Plating **	Olive green plating
9	S2453-09W-**	D38999/33 W 09 R
11	S2453-11W-**	D38999/33 W 11 R
13	S2453-13W-**	D38999/33 W 13 R
15	S2453-15W-**	D38999/33 W 15 R
17	S2453-17W-**	D38999/33 W 17 R
19	S2453-19W-**	D38999/33 W 19 R
21	S2453-21W-**	D38999/33 W 21 R
23	S2453-23W-**	D38999/33 W 23 R
25	S2453-25W-**	D38999/33 W 25 R

Shell size	Part numbers	
	Plating **	Olive green plating
9	S2453-09W**-1	D38999/33 W 09 N
11	S2453-11W**-1	D38999/33 W 11 N
13	S2453-13W**-1	D38999/33 W 13 N
15	S2453-15W**-1	D38999/33 W 15 N
17	S2453-17W**-1	D38999/33 W 17 N
19	S2453-19W**-1	D38999/33 W 19 N
21	S2453-21W**-1	D38999/33 W 21 N
23	S2453-23W**-1	D38999/33 W 23 N
25	S2453-25W**-1	D38999/33 W 25 N

Caps for plug (D38999/32 - S2454)

With rope and eyelet

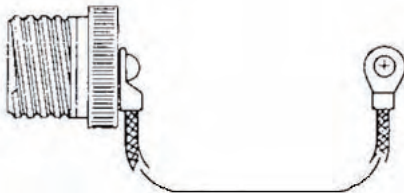

With rope and ring

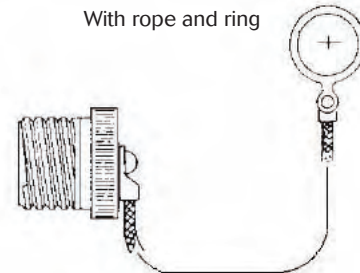

Shell size	Part numbers	
	Plating **	Olive green plating
9	S2454-09F-** S	D38999/32 W 09 R
11	S2454-11F-** S	D38999/32 W 11 R
13	S2454-13F-** S	D38999/32 W 13 R
15	S2454-15F-** S	D38999/32 W 15 R
17	S2454-17F-** S	D38999/32 W 17 R
19	S2454-19F-** S	D38999/32 W 19 R
21	S2454-21F-** S	D38999/32 W 21 R
23	S2454-23F-** S	D38999/32 W 23 R
25	S2454-25F-** S	D38999/32 W 25 R

Shell size	Part numbers	
	Plating **	Olive green plating
9	S2454-09W**-S	D38999/32 W 09 N
11	S2454-11W**-S	D38999/32 W 11 N
13	S2454-13W**-S	D38999/32 W 13 N
15	S2454-15W**-S	D38999/32 W 15 N
17	S2454-17W**-S	D38999/32 W 17 N
19	S2454-19W**-S	D38999/32 W 19 N
21	S2454-21W**-S	D38999/32 W 21 N
23	S2454-23W**-S	D38999/32 W 23 N
25	S2454-25W**-S	D38999/32 W 25 N

** Plating - 34 : Olive green cadmium. Plating - 12 : Nickel.
 Note: Method of attachment to cover and ring is optional. Please consult us.

8D Series

D38999 Aluminum Series



Connectors weight

	With contacts						Without contact					
	Plug (type 5)		Receptacle (type 0)		Receptacle (type 7)		Plug (type 5)		Receptacle (type 0)		Receptacle (type 7)	
	Male	Female	Male	Female	Male	Female	Male	Female	Male	Female	Male	Female
09 – 35	11.47	13.05	9.15	10.73	13.91	15.49	11.05	11.55	8.73	9.23	13.49	13.99
09 – 98	11.47	12.77	9.15	10.45	13.91	15.21	11.05	11.57	8.73	9.25	13.49	14.01
11 – 01	14.98	17.92	12.01	14.95	18.17	21.11	14.32	16.32	11.35	13.35	17.51	19.51
11 – 02	14.61	17.15	11.64	14.18	17.80	20.34	13.99	15.59	11.02	12.62	17.18	18.78
11 – 04	14.80	17.86	11.83	14.89	17.99	21.05	14.24	16.26	11.27	13.29	17.43	19.45
11 – 05	14.83	18.04	11.86	15.07	19.48	21.23	14.13	16.04	11.16	13.07	17.32	19.23
11 – 22	14.47	16.89	11.50	13.92	17.66	20.08	14.19	15.89	11.22	12.92	17.38	19.08
11 – 35	14.73	18.20	11.76	15.23	17.68	21.39	13.82	14.95	10.85	11.98	17.01	18.14
11 – 80	18.30	21.90	15.30	18.90	21.50	28.39	13.80	14.90	10.80	11.90	17.00	18.10
11 – 98	14.70	17.46	11.73	14.49	17.89	20.65	13.86	15.06	10.89	12.09	17.05	18.25
11 – 99	14.87	18.09	11.90	15.12	18.06	21.28	13.89	15.29	10.92	12.32	17.08	18.48
13 – 04	21.04	24.82	15.71	19.49	24.14	27.92	19.80	21.70	14.47	16.37	22.90	24.80
13 – 08	21.42	26.60	16.09	21.27	24.52	29.70	20.30	23.40	14.97	18.07	23.40	26.50
13 – 26	21.79	27.44	16.46	22.11	24.89	30.54	20.05	22.74	14.72	17.41	23.15	25.84
13 – 35	21.22	26.99	15.89	21.66	24.32	30.09	19.68	21.49	14.35	16.16	22.78	24.59
13 – 98	21.08	25.70	15.75	20.37	24.18	28.80	19.68	21.70	14.35	16.37	22.78	24.80
15 – 05	26.04	31.38	19.54	24.88	29.62	34.96	24.49	27.48	17.99	20.98	28.07	31.06
15 – 15	26.84	34.00	20.34	27.50	30.42	37.58	24.57	27.62	18.07	21.12	28.15	31.20
15 – 18	27.05	35.93	20.55	29.43	30.63	39.51	24.53	28.73	18.03	22.23	28.11	32.31
15 – 19	26.58	34.31	20.08	27.81	30.16	37.89	23.92	26.71	17.42	20.21	27.50	30.29
15 – 35	26.68	35.92	20.18	29.42	30.26	39.50	24.09	26.67	17.59	20.17	27.67	30.25
15 – 97	26.51	33.56	20.01	27.06	30.09	37.14	24.15	27.24	17.65	20.74	27.73	30.82
17 – 02	32.96	46.30	31.26	44.60	42.06	55.40	25.80	29.80	24.10	28.10	34.90	38.90
17 – 06	29.90	39.50	28.21	37.81	39.00	48.60	25.94	29.90	24.25	28.21	35.04	39.00
17 – 08	28.89	37.62	27.20	35.93	37.99	46.72	26.41	31.38	24.72	29.69	35.51	40.48
17 – 26	29.47	40.26	27.78	38.57	38.57	49.36	25.83	29.86	24.14	28.17	34.93	38.96
17 – 35	29.71	43.26	28.02	41.57	38.81	52.36	25.86	29.51	24.17	27.82	34.96	38.61
17 – 75	35.31	46.60	33.62	44.91	44.41	55.70	26.31	32.60	24.62	30.91	35.41	41.70
17 – 99	29.52	40.08	27.83	38.39	38.62	49.18	25.96	30.12	24.27	28.43	35.06	39.22
19 – 11	37.77	51.36	31.07	44.66	44.62	58.21	34.36	42.78	27.66	46.43	30.86	49.63
19 – 32	36.98	50.38	30.28	43.68	43.83	57.23	32.50	37.58	25.80	41.23	29.00	44.43
19 – 35	37.29	53.74	30.59	47.04	44.14	44.09	32.67	37.24	25.97	40.89	29.17	44.09
21 – 11	45.51	65.35	39.31	59.15	53.19	73.03	38.25	47.75	32.05	51.93	35.55	55.43
21 – 16	42.61	57.89	36.41	51.69	50.29	65.57	37.65	45.41	31.45	49.59	34.95	53.09
21 – 35	42.89	63.55	36.69	57.35	50.57	71.23	37.36	43.80	31.16	47.98	34.66	51.48
21 – 39	44.27	64.60	38.07	58.40	51.95	72.28	38.47	48.24	32.27	52.42	35.77	55.92
21 – 41	42.81	60.18	36.61	64.36	50.49	67.86	37.07	43.78	30.87	47.96	34.37	51.46
21 – 48	49.59	49.93	43.39	43.73	55.27	57.61	36.48	43.38	30.28	37.18	44.16	51.06
21 – 75	54.48	71.38	48.28	65.18	62.16	79.06	36.48	43.38	30.28	37.18	44.16	51.06
23 – 21	50.49	73.74	44.19	67.44	59.23	82.48	43.98	57.36	37.68	62.20	41.58	66.10
23 – 35	48.85	75.00	42.55	68.70	57.59	83.74	41.85	50.00	35.55	54.84	39.45	58.74
23 – 53	48.91	71.10	42.61	64.80	57.65	79.84	41.49	49.90	35.19	54.74	39.09	58.64
23 – 55	49.66	72.73	43.36	66.43	58.40	81.47	41.96	50.73	35.66	55.57	39.56	59.47
25 – 07	61.89	90.70	55.73	85.10	71.15	99.10	46.41	56.20	40.25	61.26	44.45	65.46
25 – 11	54.48	71.38	48.28	65.18	62.16	79.06	36.48	43.38	42.94	55.94	58.36	71.36
25 – 19	59.76	91.77	53.60	85.61	69.02	101.03	47.22	61.37	41.06	66.43	45.26	70.63
25 – 24	59.26	90.62	53.10	84.46	68.52	99.88	47.62	62.06	41.46	67.12	45.66	71.32
25 – 29	57.58	86.55	51.42	80.39	66.84	95.81	48.59	63.93	42.43	68.99	46.63	73.19
25 – 35	55.37	88.20	49.21	82.04	64.63	97.46	46.41	56.20	40.25	61.26	44.45	65.46
25 – 37	57.57	89.86	51.41	59.36	66.83	90.06	46.10	61.00	39.94	60.50	55.36	61.20
25 – 44	52.80	67.61	46.53	65.39	62.05	83.39	44.40	59.22	38.14	57.00	53.66	75.00
25 – 43	57.62	88.30	51.46	82.14	66.88	97.56	48.20	63.50	42.04	68.56	46.24	72.76
25 – 46	59.92	83.76	53.76	77.60	69.18	93.02	45.28	55.44	39.12	60.50	43.32	64.70
25 – 61	54.67	81.42	48.51	75.26	63.93	90.68	46.13	57.02	39.97	62.08	44.17	66.28
25 – 08	81.00	112.83	74.84	106.67	90.26	122.09	45.00	56.83	38.84	61.69	43.04	66.09
25 – 20	66.02	96.24	59.86	90.08	75.28	105.50	44.45	54.70	38.29	59.76	42.49	63.96
25 – 04	58.42	88.27	52.26	82.11	67.68	97.53	49.22	62.83	43.06	67.89	47.26	72.09

Weight in gram (+/- 15%)

8D Series Common Section



Orientations

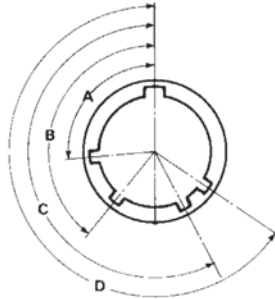

Viewed from front face of receptacle

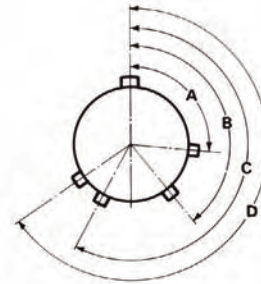

Viewed from front face of plug

Shell size	Angles	N	A	B	C	D	E
9 (A)	A°	105	102	80	35	64	91
	B°	140	132	118	140	155	131
	C°	215	248	230	205	234	197
	D°	265	320	312	275	304	240
11 (B), 13 (C) & 15 (D)	A°	95	113	90	53	119	51
	B°	141	156	145	156	146	141
	C°	208	182	195	220	176	184
	D°	236	292	252	255	298	242
17 (E), 19 (F), 21 (G), 23 (H), & 25 (J)	A°	80	135	49	66	62	79
	B°	142	170	169	140	145	153
	C°	196	200	200	200	180	197
	D°	293	310	244	257	280	272

Panel cut-out

Square flange receptacle (Type 0)

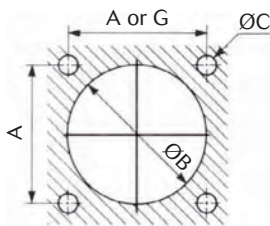

Rear mounting

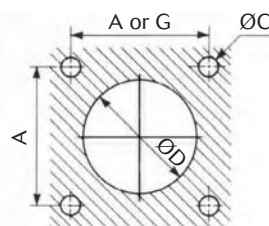

Front mounting

Jam nut receptacle (Type 7)

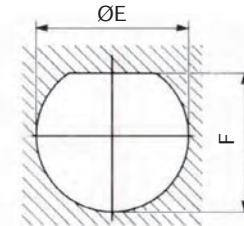

Shell size	A	G	B min.	C ± 0.13	D min.	E ± 0.25	F
9 (A)	18.26	15.09	16.66	3.25	13.11	17.78	17.02
11 (B)	20.62	18.26	20.22		15.88	20.96	19.59
13 (C)	23.01	20.62	23.42		19.05	25.65	24.26
15 (D)	24.61	23.01	26.59		23.01	28.83	27.56
17 (E)	26.97	24.61	30.96		25.81	32.01	30.73
19 (F)	29.36	26.97	32.94		28.98	35.18	33.91
21 (G)	31.75	29.36	36.12		32.16	38.35	37.08
23 (H)	34.93	31.75	39.29	3.91	34.93	41.53	40.26
25 (J)	38.10	34.94	42.47		37.69	44.70	43.43

Max. thickness panel for receptacle: Type 0: front mounting = 3.2 mm, rear mounting = 2.5 mm
Type 7: 3.2 mm











Note: All dimensions are in millimeters (mm)

8D Series

Common Section



Crimp contacts

Contact size	Contact type	Souriau Part number (without color code)	MIL-DTL-38999 contacts		
			Part number	Profile and color code	
#22D	Pin	8599-0702 JJ	M39029/58 360	 Black / Blue / Orange	
	Socket	8599-0706 900	M39029/56 348	 Grey / Yellow / Orange	
#20	Pin	8599-0703 SA	M39029/58 363	 Orange / Blue / Orange	
	Socket	8599-0707 900	M39029/56 351	 Brown / Green / Orange	
#16	Pin	8599-0704 MJ	M39029/58 364	 Yellow / Blue / Orange	
	Socket	8599-0708 900	M39029/56 352	 Red / Green / Orange	
#16 Coaxial	Pin	-	M39029/76 424	 Yellow / Red / Yellow	
	Socket	-	M39029/77 428	 Grey / Red / Yellow	
#12	Pin	8599-0705 MJ	M39029/58 365	 Green / Blue / Orange	
	Socket	8599-0709 900	M39029/56 353	 Orange / Green / Orange	
#12 Coaxial	Pin	-	M39029/102 558		
	Socket	-	M39029/103 559		
	Pin	-	M39029/28 211		
	Socket	-	M39029/75 416		
#10 Power	Pin	-	M39029/58 528		
	Socket	-	M39029/56 527		
#8 Power	Pin	8599-7544 *	-		
	Socket	8599-7541 *	-		
	Pin	8599-7580	-		
	Socket	8599-7581	-		
	Boot		8599-4542	-	For wire #8
			8599-4547	-	For wire #10
Reductor		8599-7645	-		
#8 Coaxial	Pin	-	M39029/60 367		
	Socket	-	M39029/59 366		
	Boot	8590-4571	-		
#8 Triaxial	Pin	-	M39029/90 529		
	Socket	-	M39029/91 530		
	Boot	8590-4571	-		
#4 Power	Pin	8599-7598 900 **	-	For wire 25 mm ²	
	Socket	8599-7599 900 **	-		
	Pin	8599-7534	-	For wire 21.15 mm ²	
	Socket	8599-7535	-		
	Boot	for cable 16 mm ²	8599-4594	-	
		for cable 10 mm ²	8599-4593	-	
Reductor cable 10 mm ²		8400-2351A	-		
#4 Power with reduced barrel	Pin	8599-7528 900	-	Mating part #4 / Barrel #6	
	Socket	8599-7529 900	-		
	Boot	8599-4593	-		

* JVS only. ** Not included in connector Part number. Must be ordered separately.

8D Series

Common Section



Crimp contacts

Contact size	Contact type	Contact Ø	Conductor section				External Ø over insulator	
			AWG		mm ²		Min	Max
			Min	Max	Min	Max	Min	Max
#22D	Pin	0.76	28	22	0.095	0.34	0.76	1.37
	Socket							
#20	Pin	1.00	24	20	0.21	0.60	1.02	2.11
	Socket							
#16	Pin	1.60	20	16	0.60	1.34	1.65	2.77
	Socket							
#16 Coaxial	Pin	1.60	RG 174				1.65	2.60
	Socket		RG 179 RG 316					
#12	Pin	2.40	14	12	1.91	3.18	2.46	3.61
	Socket							
#12 Coaxial	Pin	2.40	RG 174				2.40	2.60
	Socket		RG 179					
	Pin		RG 316					
	Socket							
#10 Power	Pin	3.20	Please consult us				-	2.95
	Socket							
#8 Power	Pin	3.64	-	8	-	8.98	-	-
	Socket		-	-	-	-	4.50	6.50
	Boot		-	-	-	-	2.50	4
			-	-	-	-	-	-
	Reductor		-	-	-	-	-	-
#8 Coaxial	Pin	3.64	RG 180 A/U				-	2.80
	Socket							
	Boot							
#8 Triaxial	Pin	5.50	0,76MIL-C17/176 00002				3.15	3.40
	Socket		FILECA F.2703/14					
	Boot		RAYCHEM CHEMINAX 10612 FILOTEX M 17/176 00002					
#4 Power	Pin	5.74	-	3	-	25	-	-
	Socket		5	4	16	21.15	-	-
	Pin		-	-	-	-	6.35	7.50
	Socket		-	-	-	-	4	5.80
	Boot		-	-	-	-	-	-
	Reductor cable 10 mm ²		-	-	-	-	-	-
#4 Power with reduced barrel	Pin	5.74	6		13.3		-	-
	Socket							
	Boot		-	-	-	-		

8D Series

Common Section



Straight PC tail contacts

Contact size	Contact type	PC tail type	Part number	Profile
#22D	Pin	L	8599-0720 900	
	Pin	L	8599-0750 900	-
	Pin	M	8599-8028 900	-
	Pin	C	8599-0730 900	
	Pin	S	8599-0796 900	
	Socket	L	8599-0721 900	
	Socket	C	8599-0731 900	
	Socket	S	8599-0797 900	
#20	Pin	M	8599-0658 JJ	-
	Socket	M	8599-0759 900	-
	Pin	C	8599-0724 900	
	Socket	C	8599-0725 900	
	Pin	L	8599-0771 900	-
#16	Pin	C	8599-0726 900	-
	Pin	C	8599-07482A 900	-
	Socket	C	8599-0727 900	
Coaxial #16	Pin	C	8599-1000 900	
#12	Pin	C	8599-7929 900	
	Socket	C	8599-7932 900	-
	Socket	C	8599-7485A 900	-

S: Specific PC tail
 L: Long PC tail
 M: Medium PC tail
 C: Short PC tail

8D Series

Common Section



Coaxial contacts #12

Designation	Part number
Coaxial socket solder #12	THA1-0151A
Coaxial pin solder #12	THA1-0152A
Coaxial pin crimp contact #12	THA1-0155A
Coaxial crimp contact #12	THA1-0156A

Solder cup



Contact size	Contact type	Part number
#22D	Pin	8599-0750 900
#16	Pin	8599-7482A 900
#12	Socket	8599-7485A 900

For other contacts type please consult us.

Crimp contacts: 1500 mating

Contact size	MIL-DTL-38999 contacts		
	Contact type	Part number	Color code
#22D	Pin (H)	M39029/107 620	Blue / Red / Black
	Socket (J)	M39029/106 614	Blue / Brown / Yellow
#20	Pin (H)	M39029/107 621	Blue / Red / Brown
	Socket (J)	M39029/106 615	Blue / Brown / Green
#16	Pin (H)	M39029/107 622	Blue / Red / Red
	Socket (J)	M39029/106 616	Blue / Brown / Blue
#12	Pin (H)	M39029/107 623	Blue / Red / Orange
	Socket (J)	M39029/106 617	Blue / Brown / Gray

Wire wrap contacts

Contact size	Contact type	Part number	Contact Ø (mm)	Profile	 (mm)
#22D	Pin	8599-0790 JJ	0.76		0.86
#20	Pin	8599-0791 900	1		0.86

Quadrax #8 contacts







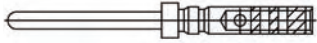

Contact type	Version	Souriau Part Number	Cross Norm	T°	Impedance	Sealing	Release
Pin	PCB mount	ETH1-1237A	-	125°C	100Ω	Sealed	Rear
		ETH1-1501A	-		150Ω		
	Crimp	ETH1-1345A	EN3155-074	200°C	100Ω		
		ETH1-1503A	-		150Ω		
Socket	PCB mount	ETH1-1238A	-	125°C	100Ω		
		ETH1-1502A	-		150Ω		
	Crimp	ETH1-1346A	EN3155-075	200°C	100Ω		
		ETH1-1504A	-		150Ω		

8D Series

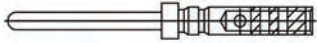
Common Section



Thermocouple contacts

Contact size	Contact type	Souriau part numbers (without color code)	MIL-DTL-38999 contacts		Ø Contact (mm)	Wire section				Ø Over insulation (mm)	
			Part numbers	Profile and color code		Awg		mm ²		min	max
						min	max	min	max		
#22D Chromel	Pin	-	M39029/87-472	 Red / Violet / Yellow	0.75	28	22	0.095	0.34	0.76	1.37
	Socket	-	M39029/88-484	 Yellow / Grey / Yellow							
#22D Alumel	Pin	-	M39029/87-471	 Brown / Violet / Yellow	1	24	20	0.21	0.6	1.02	2.11
	Socket	-	M39029/88-483	 Orange / Grey / Yellow							
#20 Chromel	Pin	8599-0749 900	8599-0949 900	 Blue / Violet / Yellow	1	24	20	0.21	0.6	1.02	2.11
	Socket	8599-0753 900	8599-0953 900	 Grey / Grey / Yellow							
#20 Alumel	Pin	8599-0761 900	8599-0961 900	 Green / Violet / Yellow	1	24	20	0.21	0.6	1.02	2.11
	Socket	8599-0765 900	8599-0965 900	 Violet / Grey / Yellow							

Dummy contacts

Size	Part number
#16	8599-6A016001A
#8	8599-0308
#4	8599-0310

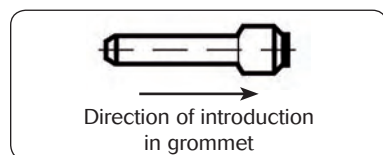

Filler plugs

Contact size	Filler plugs		
	MS Part number (Rev. N)	Souriau Part number	Color
#22D	MS27488-22-2	8660-212	Black
#20	MS27488-20-2	8522-389A	Red
#16	MS27488-16-2	8522-390A	Blue
#12	MS27488-12-2	8522-391A	Yellow

8D Series

Common Section



Insertion & extraction tools

Contact size	Material	Part number		Color	
		MIL standard	Souriau	Insertion	Extraction
#22D	Plastic	M81969/14-01	-	Green	White
#20	Plastic	M81969/14-10	-	Red	Orange
#16	Plastic	M81969/14-03	-	Blue	White
#12	Plastic	M81969/14-04	-	Yellow	White
#10	Plastic	M81969/14-05	-	Grey	-
#8	Plastic	M81969/14-12	-	-	Green
	Metalic	-	8660-197	-	-
#4	Plastic	M81969/14-07	-	-	Blue
	Metalic	-	8533-8175	-	-

Crimping tools

Contact size	Contact type	Plier M22520/1-01		Plier M22520/2-01 (Souriau 8476-01)		Plier M300BT	Plier * M22520/23-01	
		Turret Part number		Locator Part number		Locator Part number	Turret Part number	Locator Part number
		Norm	Souriau	Norm	Souriau			
#22D	Pin	-	-	M22520/2-09	8476-09	-	-	-
	Socket	-	-	M22520/2-07	8476-07	-	-	-
#20	Pin	M22520/1-04	8365-04	M22520/2-10	8476-10	-	-	-
	Socket					-	-	-
#16	Pin	M22520/1-04	8365-04	-	-	-	-	-
	Socket			-	-	-	-	
#12	Pin	M22520/1-04	8365-04	-	-	-	-	-
	Socket			-	-	-	-	
#8 Power	Pin	-	-	-	-	SP 593	M22520/23-02	8599-9601
	Socket	-	-	-	-			
#4 Power	pin	-	-	-	-	-	M22520/23-04	M22520/23-11
	Socket	-	-	-	-	-		

Contact size	Contact type	Plier M22520/2-01 (Souriau 8476-01)	Plier M22520/31-01	Plier M22520/4-01	Plier M22520/5-01
		Locator Part Number	Locator Part number	Locator Part Number	Die set Part Number
#12 Coaxial M39029/102-558 M39029/103-559	Inner	-	-	-	M22520/5-03
	Outer	-	-	-	
#12 Coaxial M39029/28-211 M39029/75-416	Inner	M22520/2-34	-	-	-
	Outer	-	M22520/31-02	-	-
#16 Coaxial	Inner	M22520/2-35	-	-	-
	Outer	-	-	M22520/4-02	-
#8 Coaxial	Inner	M22520/2-31	-	-	-
	Outer	-	-	-	M22520/5-05 closure B
#8 Triaxial	Inner	K709	-	-	-
	Middle	-	-	-	Y631 closure B
	Ferrule	-	-	-	Y631 closure A

* Pneumatic plier

Note: for the #10 contact's plier and locator, please consult us.

8D Series

Common Section



Wiring instruction

Cable preparation and wire stripping

Contact size	#22D	#20	#16	#12	#8	#4
L min	3.58 .14	5.31 .21	5.31 .21	5.31 .21	12.5 .49	12.5 .49
L max	3.99 .16	5.82 .23	5.82 .23	5.82 .23	13 .51	13 .51

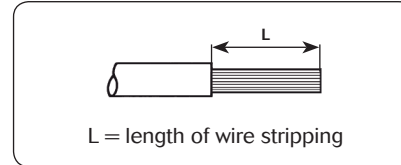

Insertion of wire in contact barrel

When inserting the stripped wire into the contact barrel check that no strands are left outside and that the wire is visible through the wire inspection hole in the barrel.

Important :

- Slide any accessories over wire strands before carrying out the following operations.
- Contacts are inserted and extracted from the rear of the connector.

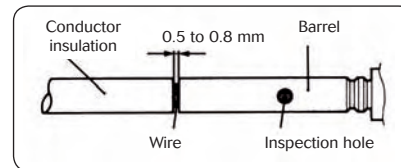

Insertion of the contacts

1 - Engage the crimp cable / contact assembly into the longitudinal slot of the plastic tool (coloured tip). Slide the tool down the cable until the tip of the tool abuts the contact retention shoulder.

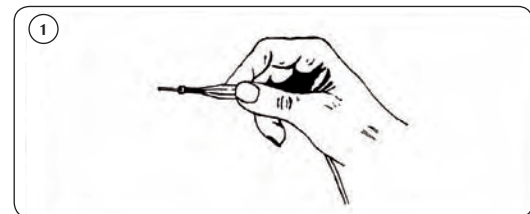

2 - Introduce the contact into the required contact cavity in the insulator, pushing tool axially, until the contact snaps into position in clip.

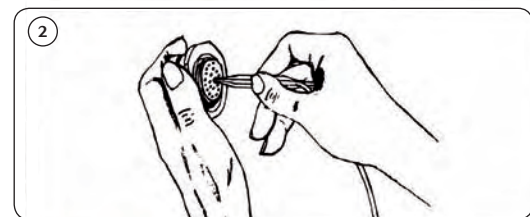

3 - Withdraw the tool (from rear). Check that contact is firmly locked by pulling wire gently. When connector is fully loaded, check the position of contact tips. They should all be in the same plane.

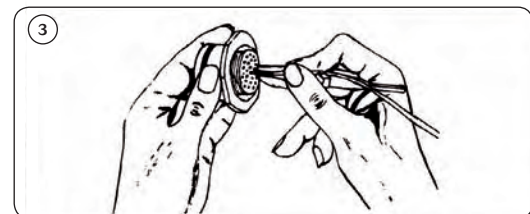

Nota : For larger sizes of cable which are stiff enough manual insertion without tool is preferable.

8D Series

Common Section



Wiring instruction

Extraction of the contacts

1 - Engage the appropriate cable into the longitudinal slot of the tool with the white tip towards connector.

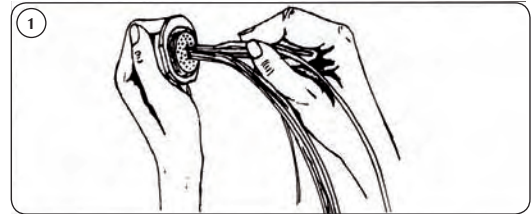

2 - Slide the tool down towards the contact. Insert the tool in the insulator until it abuts the contact shoulder.

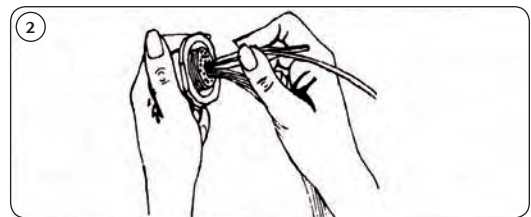

3 - Holding the tool-contact and cable assembly together, remove them simultaneously.

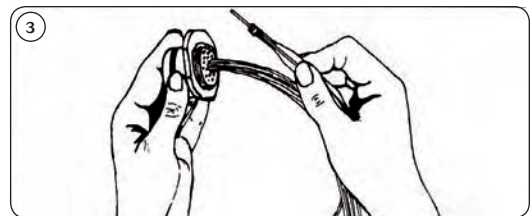

Backshell tightening and slackening tools

Backshell tightening pliers, part number : 8498-03

Square jaws, part number : 8500-1015 (order 2 jaws)

Strap clamp : 8498-04

Spare strap : 8498-103

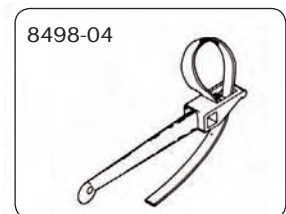
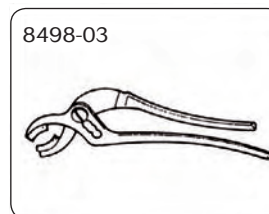

Tightening support

Part number: 8599-0831

This tool is made up of dummy receptable housings of all 9 sizes for all key polarisation, and locates free connectors during wiring and fitting of rear accessories.

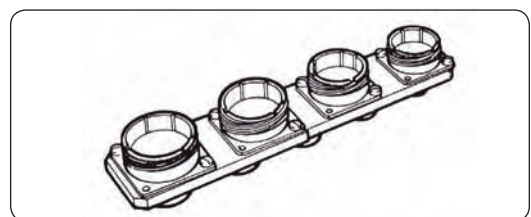

8D Series

Common Section



Gaskets

Shell size	Gasket for receptacles Type 0* (ordered separately)	O ring for receptacle Type 7
9 (A)	8599-5541	AS3582-019
11 (B)	8599-5542	AS3582-022
13 (C)	8599-5543	AS3582-024
15 (D)	8599-5544	AS3582-026
17 (E)	8599-5545	AS3582-028
19 (F)	8599-5546	AS3582-128
21 (G)	8599-5547	AS3582-130
23 (H)	8599-5548	AS3582-132
25 (J)	8599-5549	AS3582-134

*For front mounting

Plastic protective caps*

Shell size	Caps for receptacles	Caps for plugs	Caps for composite plugs only (J & M)	Antistatic caps for receptacles	Antistatic caps for plugs
9 (A)	70777	8500-5587 A	MS90376-12R	70777N	8500-5587N
11 (B)	MS90376-12R	70198	8500-5598	MS9037612RF	8500-5588N
13 (C)	MS90376-14R	8500-5600	8500-5600	MS9037614RF	8500-5600N
15 (D)	MS90376-16R	8500-5601	8500-5601	MS9037616RF	8500-5601N
17 (E)	70201	8500-5602	8500-5602	70201N	8500-5602N
19 (F)	70209	8500-5592 A	8500-5592 A	8500-5590N	8500-5592N
21 (G)	MS90376-22R	8500-5593 A	8500-5593 A	8500-5591N	8500-5593N
23 (H)	MS90376-24R	8500-5593 A	70472	8500-5592N	8500-5591N
25 (J)	8500-5593 A	J599ABC6009A00	J599ABC6009A00	8500-5593N	8500-5592N

*Excepted 8D composite version (X): supplied without cap