



851 Series

MIL-DTL-26482 Connectors



SOURIAU



851 Series

Sommaire / Contents

• Sommaire / Contents.....	3	• Accessoires / Accessories.....	42
• Etendue de la gamme / Product Overview.....	3	• Bouchons / Caps.....	44-45
• Présentation / Presentation.....	4-5	• Références des raccords / Backshell ordering information.....	46-47
• Description / Description.....	6	• Outillages / Tools.....	48-50
• Tableau comparatif références SOURIAU et normes équivalentes / Cross reference list.....	7-8	• Notice de câblage / Wiring instructions.....	51
• Caractéristiques techniques / Technical characteristics.....	9	• Sertissage / Crimping.....	52-54
• Contacts / Contacts.....	10	• Schémas d'implantations pour circuits imprimés / Coordinates for PC tail.....	55-59
• Références / Ordering information.....	11-13	• Prise largable push-pull / Push-pull lanyard release plug.....	60-61
• Arrangements / Contact layouts.....	14-15	• Connecteurs filtres 8F51 / 8F51 filter connector.....	62
• Positionnements / Orientations.....	16	• Connecteurs spécifiques & accessoires SNC / Specific products & SNC accessories.....	63
• Encombrements Connecteurs Etanches / Dimensions Environmental Connectors.....	17-38	• Traversée de cloison 851 RJ45 / 851 RJ45 feedthru.....	65-68
• Encombrements Connecteurs Hermétiques / Dimensions Hermetic Connectors.....	39-40	• Traversée de cloison 851 USB / 851 USB feedthru.....	69-72
• Encombrements Connecteurs pour connexions enroulées et à picots droits / Dimensions Wire-wrap and PC tail Connectors.....	40-41	• 8XE / 8XE.....	73-76
• Perçage cloison / Panel cut-out.....	41	• Protection sans cadmium / Cadmium free plating.....	77

Etendue de la gamme / Product Overview

851
page 4-63



851 RJ45 Feedthru
page 65-68



851 USB Feedthru
page 69-72



8XE
page 73-76





Présentation

- Versions étanches et hermétiques
- Large choix de raccords et accessoires
- Protection cadmiée vert olive, oxydée anodique noire, nickelée ou zinc nickel
- Contacts à souder, à sertir, à picot droit ou pour enroulement de fils
- Contacts spéciaux thermocouples
- La version 851 avec contacts à souder est qualifiée QPL (USA)
- La gamme 851 est aussi commercialisée par un réseau de distributeurs.

Les connecteurs circulaires 851 Souriau, initialement conçus pour la connexion des circuits électriques en aéronautique et armement, ont aujourd'hui conquis les domaines diversifiés de l'électricité et de l'électronique industrielles (Mesure, Instrumentation, Transport, Machine, Outil, Productique...).

Ils correspondent aux normes et spécifications internationales et nationales en vigueur MIL-DTL-26482G série 1, NFC 93422, HE 301B, VG 95328, liste GAM/T1.

Les connecteurs fixes (embases) et mobiles (fiches), mâles ou femelles, se verrouillent entre eux par un système mécanique endurant du type à baïonnette à 3 rampes hélicoïdales.

Cinq clavettes de guidage longitudinal et cinq positionnements angulaires possibles de l'isolant assurent le détrompage entre connecteurs.

Les mécaniques sont en alliage d'aluminium traité et protégé pour la version 851 étanche, et en acier protégé pour la version 851 hermétique.

Les isolants sont en élastomère de la classe +125°C pour la version étanche et en verre pour la version hermétique.

Les contacts sont dorés ou étamés sur sous-couche nickel.

Nous proposons, afin de faciliter le câblage, des contacts à souder et à picot taille 20 (y compris version hermétique) avec protection dorure sur la partie avant et étamage sur la partie arrière.

851 Series



Presentation

- Sealed and hermetic types
- Wide choice of body styles and back fittings
- Olive green, black anodised, nickel or zinc nickel plated
- Solder, crimp, PC-tail and wire-wrap versions
- Thermocouple crimp contacts available
- The 851 version with solder contacts is on US QPL
- 851 connectors are also widely available from distributors.

Souriau 851 circular connectors were originally conceived to ensure reliable electrical connections in aircraft but their lightweight compact size and general characteristics have contributed to successful adoption in numerous civil and military aviation applications and also in the fields of professional and general electronics (machine tools, automation, measuring equipment...).

851 connectors conform to the following international standards, MIL-DTL-26482G series 1, NFC 93422, HE 301B, VG 95328, GAM/T1 list.

851 connectors feature a positive bayonet coupling mechanism which ensures reliable mechanical and electrical connection between mating halves. A helical locking ring on the plug couples with three dowel pegs on the receptacle ensuring rapid locking. Orientation and location is ensured by a system of five raised keys on the plugs which couple with corresponding slots on the receptacles. Connectors with different angular positioning of the insulator relative to the shell can be provided to prevent mating of adjacent connectors with the same contact arrangements.

The connector shells are manufactured from aluminium alloy. The insulators are moulded from elastomer and are bonded into the shells. Grommets are also made from elastomer and are supplied with appropriate accessories in the solder version, but are integral with the insulator for the crimp version. Copper alloy contacts have gold or tin over nickel plating.

Hermetic receptacles with gold plated solder contacts are made from steel shells with nickel plating (01H) or yellow cadmium plating (02H and 07H). The contacts are permanently fused into a glass insulator providing a high level of sealing.

To facilitate cabling we offer solder and straight spill contacts size 20 (including hermetic versions) with a gold plated active part and tin plated terminations.



851 Series

Description

Connecteurs assemblés avec contacts à sertir à clips

Connectors with clip retained crimp contacts

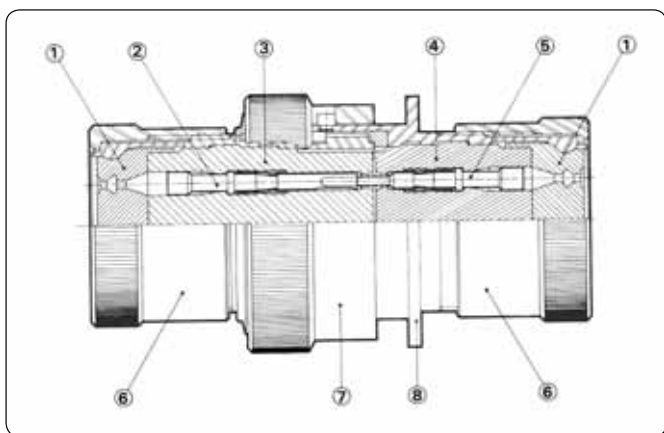

- | | |
|----------------------------------|------------------------------|
| 1 • Isolant arrière (passe-fils) | 1 • Rear insulator (grommet) |
| 2 • Contact femelle à sertir | 2 • Female crimp contact |
| 3 • Isolant femelle | 3 • Female insulator |
| 4 • Isolant mâle | 4 • Male insulator |
| 5 • Contact mâle à sertir | 5 • Male crimp contact |
| 6 • Raccord simple | 6 • Backnut |
| 7 • Corps de fiche | 7 • Plug body |
| 8 • Embase | 8 • Receptacle |

Connecteurs assemblés avec contacts à souder

Connectors assemblies with solder contacts

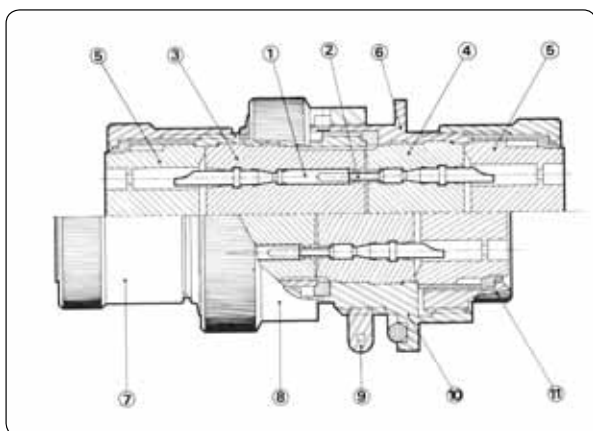

- | | |
|--|---------------------------------------|
| 1 • Contact femelle à souder | 1 • Female solder contact |
| 2 • Contact mâle à souder | 2 • Male solder contact |
| 3 • Isolant femelle | 3 • Female insulator |
| 4 • Isolant mâle | 4 • Male insulator |
| 5 • Isolant arrière (passe-fils) | 5 • Rear insulator (grommet) |
| 6 • Embase à collerette carrée | 6 • Square flange receptacle |
| 7 • Raccord simple | 7 • Backnut |
| 8 • Corps de fiche | 8 • Plug body |
| 9 • Ecrou de fixation | 9 • Fixing nut |
| 10 • Embase à fixation par écrou | 10 • Jam nut receptacle |
| 11 • Raccord simple (pour embase à fixation par écrou) | 11 • Backnut (for jam nut receptacle) |

Connecteurs assemblés (embase avec contacts à picots ou avec contacts pour connexions enroulées)

Connectors assemblies (receptacle with PC tail or wire-wrap terminals)

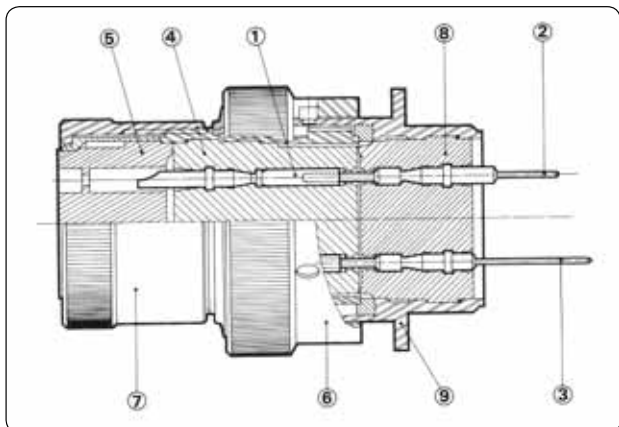

- | | |
|---|--|
| 1 • Contact mâle ou femelle à souder ou à sertir | 1 • Male or female crimp or solder contact |
| 2 • Contact mâle ou femelle à picots droits | 2 • Male or female PC tail contact |
| 3 • Contact mâle ou femelle pour connexions enroulées | 3 • Male or female wire-wrap contact |
| 4 • Isolant mâle ou femelle | 4 • Male or female insulator |
| 5 • Isolant arrière (passe-fils) | 5 • Rear insulator (grommet) |
| 6 • Corps de fiche | 6 • Plug body |
| 7 • Raccord simple | 7 • Backnut |
| 8 • Isolant mâle ou femelle | 8 • Male or female insulator |
| 9 • Embase sans possibilité de raccord | 9 • Receptacle not suitable for backshells |

851 Series



Tableau comparatif / *Cross refence list*

Version 851 avec contacts à sertir (protection vert olive)
 851 Version with crimp contacts (olive green cadmium plating)

Connecteurs avec raccords / *Connectors with backshells*

SOURIAU	NCF 93422 (modèle HE 301B)	MIL-DTL-26482G série 1	VG 95328
851 00 R 50 ..	HE 301 B 00 R 1A	* MS 3120 E	VG 95328 A
851 00 RC 50 ..	HE 301 B 00 RC 1A	* MS 3120 F	VG 95328 B
851 00 RP 50 ..	HE 301 B 00 RP 1A	* MS 3120 P	
851 00 RG 50 ..			VG 95328 R
851 00 RA 50 ..	HE 301 B 00 RA 1A		
851 01 R 50 ..	HE 301 B 01 R 1A	* MS 3121 E	
851 01 RC 50 ..	HE 301 B 01 RC 1A	* MS 3121 F	
851 01 RP 50 ..	HE 301 B 01 RP 1A	* MS 3121 P	
851 01 RA 50 ..	HE 301 B 01 RA 1A		
851 02 R 50 ..	HE 301 B 02 R 1A	* MS 3122 E	VG 95328 C
851 06 R 50 ..	HE 301 B 06 R 1A	* MS 3126 E	
851 06 RC 50 ..	HE 301 B 06 RC 1A	* MS 3126 F	VG 95328 K
851 06 RP 50 ..	HE 301 B 06 RP 1A	* MS 3126 P	
851 06 RT 50 ..			VG 95328 J
851 06 RA 50 ..	HE 301 B 06 RA 1A		
851 36 RG 50 ..			VG 95328 M
851 36 RA 50 ..			
851 07 R 50 ..	HE 301 B 07 R 1A	* MS 3124 E	VG 95328 D
851 07 RC 50 ..	HE 301 B 07 RC 1A	* MS 3124 F	VG 95328 E
851 07 RP 50 ..	HE 301 B 07 RP 1A	* MS 3124 P	
851 07 RT 50 ..			VG 95328 S
851 07 RG 50 ..			VG 95328 T
851 76 RU 50 ..			
851 08 RC 50 ..	HE 301 B 08 RC 1A		
851 08 RP 50 ..	HE 301 B 08 RP 1A		

* Non QPL - *Not QPL*

Autres protections / *Other plating*

Protections <i>Plating</i>	SOURIAU		NFC 93422 (modèle HE 301B)
	Version à souder/ <i>Solder version</i>	Version à sertir/ <i>Crimp version</i>	
Anodique noire <i>Black anodised</i>	851 5029	851 50031	HE 301B 4A
Nickelé <i>Nickel</i>	851 5044	851 5044	HE 301B 5A
Zinc Nickel RoHS <i>Zinc Nickel RoHS</i>	851 57	851 57	-

851 Series



Tableau comparatif / *Cross reference list*

Version 851 avec contacts à souder (protection vert olive)

851 Version with solder contacts (olive green cadmium plating)

Connecteurs avec raccords / *Connectors with backshells*

SOURIAU	NCF 93422 (modèle HE 301B)	MIL-DTL-26482G série 1	VG 95328
851 00 E 50 ..	HE 301 B 00 E 1A	MS 3110 E	
851 00 EC 50 ..	HE 301 B 00 EC 1A	MS 3110 F	
851 00 AC 50 ..	HE 301 B 00 AC 1A		
851 00 P 50 ..	HE 301 B 00 P 1A	MS 3110 P	
851 00 A 50 ..	HE 301 B 00 A 1A		
851 00 J 50 ..	HE 301 B 00 J 1A		
851 00 JC 50 ..		MS 3110 J	
851 01 E 50 ..	HE 301 B 01 E 1A	MS 3111 E	
851 01 EC 50 ..	HE 301 B 01 EC 1A	MS 3111 F	
851 01 AC 50 ..	HE 301 B 01 AC 1A		
851 01 P 50 ..	HE 301 B 01 P 1A	MS 3111 P	
851 01 A 50 ..	HE 301 B 01 A 1A		
851 01 J 50 ..	HE 301 B 01 J 1A		
851 01 JC 50 ..		MS 3111 J	
851 02 E 50 ..	HE 301 B 02 E 1A	MS 3112 E	VG 95328 H
851 06 E 50 ..	HE 301 B 06 E 1A	MS 3116 E	
851 06 EC 50 ..	HE 301 B 06 EC 1A	MS 3116 F	
851 06 AC 50 ..	HE 301 B 06 AC 1A		
851 06 P 50 ..	HE 301 B 06 P 1A	MS 3116 P	
851 06 A 50 ..	HE 301 B 06 A 1A		
851 06 J 50 ..	HE 301 B 06 J 1A		
851 06 JC 50 ..		MS 3116 J	
851 08 EC 50 ..	HE 301 B 08 EC 1A		
851 08 P 50 ..	HE 301 B 08 P 1A		
851 07 E 50 ..	HE 301 B 07 E 1A	MS 3114 E	
851 07 EC 50 ..	HE 301 B 07 EC 1A	MS 3114 F	
851 07 AC 50 ..	HE 301 B 07 AC 1A		
851 07 P 50 ..	HE 301 B 07 P 1A	MS 3114 P	
851 07 A 50 ..	HE 301 B 07 A 1A		

Version 851 hermétique / *851 Hermetic version*

SOURIAU	NFC 93422 (modèle HE 301B)	MIL-DTL-26482G série 1	VG 95328
851 02 H ... P.50	HE 301 B 02 H ... P.3A		
851 07 H ... P.50	HE 301 B 07 H ... P.3A	* MS 3114 H P.	VG 95328 F
851 I H ... P.50	HE 301 B 1 H ... P.3A	* MS 3113 H P.	VG 95328 G

* Non QPL - *Not QPL*



Caractéristiques techniques / Technical characteristics

Mécaniques

Boîtier

- Version étanche : alliage d'aluminium
- Protection : - cadmié vert olive
 - oxydation anodique noire
 - cadmium incolore
 - nickelé satiné brillant
 - zinc cobalt (vert olive)
 - zinc nickel
- Version hermétique : acier
- Protection : - cadmié jaune irisé
 - nickelé

Isolant

- Partie avant : élastomère néoprène (dureté 85 shore)
- Partie arrière (passe-fils) : élastomère néoprène (dureté 40 shore)

Contact

- A sertir : montable et démontable par l'arrière de l'isolant et retenu par clips métalliques, à souder et à picot non démontable, à connexion enroulée démontable et non démontable
- Matière : alliage cuivreux
- Protection : or ou sur parties actives et étain/plomb sur parties raccordement
- Effort mini de rétention des contacts dans l'isolant

Taille des contacts	A sertir à clip	A souder A picot A wrapper
20 (Ø1mm)	≥ 68 N	≥ 68 N
16 (Ø1.6mm)	≥ 113 N	≥ 113 N

- Endurance mécanique : 500 cycles complets (verrouillage et déverrouillage)

Vibration

Selon NFC 20-616

Mechanical

Shell

- Environmental version : aluminium alloy
- Plating : - olive green cadmium
 - black anodised
 - white cadmium
 - satin finish bright nickel
 - zinc cobalt (olive green)
 - zinc nickel
- Hermetic version : steel
- Plating : - iridescent yellow cadmium
 - nickel

Isolant

- Front section : neoprene elastomer (85 shore)
- Rear section : neoprene elastomer (40 shore)

Contact

- Crimp : inserted and removed from rear of insulator retained by metallic clips, solder

and PC tail, non removable, wire-wrap removable or not removable

- Material : copper alloy
- Plating : gold overall or gold plated active zone and tin/lead plated termination
- Min retention force of contacts in insulator

Contact size	Crimp	Solder PC tail Wire wrap
20 (Ø1mm)	≥ 68 N	≥ 68 N
16 (Ø1.6mm)	≥ 113 N	≥ 113 N

- Mechanical endurance : 500 cycles (full mating-unmating)

Vibration

To NFC 20-616

Electriques

Tension de tenue

- A pression normale : connecteurs accouplés et non accouplés
 - 1500 Veff entre contacts taille 20 (service 1)
 - 2300 Veff entre contacts taille 16 (service 2)
 - 1500 Veff entre contacts panachés de taille 16 et de taille 20 (service 1)
- A basse pression 10 mbar : connecteurs accouplés et non accouplés
 - 200 Veff entre contacts taille 20 (service 1)
 - 300 Veff entre contacts taille 16 (service 2)

Résistance d'isolement

≥ 5000 MΩ sous 500 Vcc

Intensité admissible par contact

Taille 20 = 7,5 A / Taille 16 = 13 A

Résistance de contact

- Version étanche : Taille 20 ≤ 4 mΩ / Taille 16 ≤ 3 mΩ
- Version hermétique : Taille 20 ≤ 30 mΩ / Taille 16 ≤ 14 mΩ

Blindage

70 dB à 5 MHz / 40 dB à 100 MHz

Tension de claquage mini

Breakdown voltage (mini)

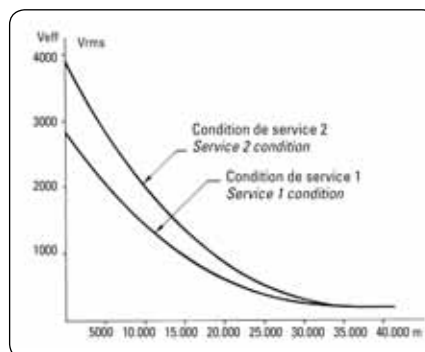

Electrical

Dielectric withstanding voltage

- At standard pressure : mated and unmated connectors
 - 1500 Vrms between size 20 contacts (service 1)
 - 2300 Vrms between size 16 contacts (service 2)
 - 1500 Vrms between mixed size 20 and 16 contacts (service 1)
- At reduced pressure 10 mbar : connectors mated and unmated
 - 200 Vrms between size 20 contacts (service 1)
 - 300 Vrms between size 16 contacts (service 2)

Insulation resistance

≥ 5000 MΩ under 500 Vcc

Current rating per contact

Size 20 = 7.5 A / Size 16 = 13 A

Contact resistance

- Environmental version : Taille 20 ≤ 4 mΩ / Taille 16 ≤ 3 mΩ
- Hermetic version : Taille 20 ≤ 30 mΩ / Taille 16 ≤ 14 mΩ

Shielding

70 dB to 5 MHz / 40 dB to 100 MHz

Climatiques

Température d'utilisation

-55°C à +125°C

Étanchéité

- Version contact à sertir sous pression différentielle de 1 bar, fuite ≤ 8 cm³/heure
- Version contact à souder sous pression différentielle de 2 bars, fuite ≤ 16 cm³/heure

Herméticité

- Sous pression différentielle de 1 bar, fuite ≤ 2,8 mm³/heure

Tenue aux agents chimiques : suivant norme MIL-DTL-26482G série 1 et NFC 93422 - HE 301 B code A

Résistance au brouillard salin

- 48 heures, à température ambiante

Chaleur humide : 21 jours

Climatic

Working temperature

-55°C to +125°C

Sealing

- Crimp contact version, 1 bar differential pressure, leakage ≤ 8 cm³/hr
- Solder contact version, 2 bar differential pressure, leakage ≤ 16 cm³/hr

Hermeticity

- 1 bar differential pressure, leakage ≤ 2,8 mm³/hr

Chemical resistance : to MIL-DTL-26482G series 1 and NFC 93422 - HE 301 B code A

Resistance to salt spray

- 48 hours at environmental temperature

Damp heat : 21 days



Contacts

Contacts à sertir / *Crimp contacts*

Type de contact / <i>Contact type</i>			Taille de contact <i>Contact size</i>	Références <i>Part numbers</i>	Câble admissible <i>Cable acceptance</i>		Ø extérieur sur gaine <i>Ø over insulation</i>		
					Section (mm²)	Jauge <i>Gauge AWG</i>	min.	max.	
standards standard	mâle male	pour arrange- ments 8-2, 8-3, 8-4 & 12-14 for layouts 8-2, 8-3, 8-4 & 12-14	20	8500-9573*	0.21 à/to 0.93	24 à/to 18	1.20	2.11	
	femelle female			8500-9213 900*					
	mâle male			8500-697					
	femelle female			8500-1758A 900					
		mâle male	16	8500-1300	0.93 à/to 1.91	18 à/to 14	1.60	2.80	
	femelle female	8500-9331 900							
embout réducteur reducing sleeve			20	8500-781 B1	0.06 à/to 0.21	30 à/to 24			
			16	8500-1985 B1	0.60	20			
thermocouple thermocouple	chromel	mâle male	20	8500-809 A	0.21 à/to 0.93	24 à/to 18	1.20	2.11	
	alumel			8500-812 A					
	chromel			8500-2054 900					
	alumel			8500-2055 900					
	chromel	mâle male	16	8500-1053	0.93 à/to 1.91	18 à/to 14	1.60	2.80	
	alumel			8500-1058					
	chromel			8500-1054 900					
	alumel			8500-1059 900					

Contacts pour connexions enroulées / *Wire-wrap contacts*

Type de contact <i>Contact type</i>		Taille de contact <i>Contact size</i>	Références <i>Part numbers</i>	Diagonales <i>Diagonals</i>	Jauge <i>Gauge (AWG)</i>	Nombre d'en- roulements <i>Number of wraps</i>	
	mâle male	20	8500-4220 MQ	0.78 0.85	26 28 30	3	
	femelle female		8500-9351 900	0.78 0.85	26 28 30	3	
	mâle male	16	8500-4304 LY	1.55 1.70	20 22 24 26	3	
	femelle female		8500-4305 900	1.55 1.70	20 22 24 26	3	



851 Series

Références / Ordering Information

Connecteurs étanches / Environmental connectors

Racine / <i>Basic series</i>	Version à souder / <i>Solder version</i>	851	00	E	8	3A	P	-	50	---
Version à sertir / <i>Crimp version</i>		851	00	R	8	3A	P	-	50	---

Type de boîtier / *Shell type*

à souder / <i>solder</i>	à sertir / <i>crimp</i>	Description
00	00	embase à collerette carrée avec possibilité de raccord <i>square flange receptacle accepting backshells</i>
01	01	prolongateur / <i>cable connecting receptacle</i>
02E	02R	embase à collerette carrée sans possibilité de raccord <i>square flange receptacle not accepting backshells</i>
07	07	embase à fixation par écrou avec possibilité de raccord <i>jam nut receptacle accepting backshells</i>
07A		embase à fixation par écrou sans possibilité de raccord <i>jam nut receptacle not accepting backshells</i>
06	06	fiche droite sans bague de blindage <i>plug for use with straight backshells</i>
08	08	fiche avec raccord coudé sans bague de blindage <i>plug for use with 90° backshells</i>
36	36	fiche droite avec bague de blindage <i>screened plug for use with straight backshells</i>
76	76	fiche droite avec bague de blindage et doigt de verrouillage <i>screened plug with lock finger</i>

Type de raccord / *Backshell type*

Voir tableau page 12 - *See table page 12*

Taille de boîtier / *Shell size*

8 - 10 - 12 - 14 - 16 - 18 - 20 - 22 - 24

Arrangements / *Contact layouts*

Voir tableau page 14/15 - *See table page 14/15*

Type de contact / *Contact type*

P = mâle/male - S = femelle/female

Positionnement / *Orientation*

Normal (n'apparaît pas dans la référence) w, x, y, z - voir tableau page 16

Normal (not included in part number) w, x, y, z - see table page 16

Indice obligatoire / *Obligatory suffix*

- B version à sertir sans clip avec arrangements 8-2 / 8-3 / 8-4 / 12-14 *crimped version without clip which used layouts 8-2 / 8-3 / 8-4 / 12-14*
- 50 contacts à sertir: dorés, toutes tailles / *crimp contacts: gold plated, all sizes*
contacts à souder: taille 20, contacts dorés en partie active + étamés en partie arrière sauf arrangements 8-2, 8-3, 8-4 & 12-14; taille 16, contacts dorés; mixte taille 20 & 16, contacts dorés / *Solder contacts: size 20, contacts with gold plated active zone + tin plated termination area except layouts 8-2, 8-3, 8-4 & 12-14; size 16, gold plated contacts all over; Mix size 20 & 16, gold plated contacts all over*
- 51 contacts à souder taille 20: dorés / *solder contacts gold plated size 20*
- 54 protection zinc nickel noir (contacts: idem spécif.50) / *black zinc nickel plating (contacts idem specif.50)*
- 57 protection zinc nickel noir (contacts dorés: idem spécif.50) / *black zinc nickel plating (gold plated contacts idem specif.50)*

Spécification / *Specification*

sans spécification: protection cadmiée vert olive / *without specification: olive green cadmium plating*

29 protection oxydation anodique noire (version à souder) / *black anodised (solder version)*

031 protection oxydation anodique noire (version à sertir) / *black anodised (crimp version)*

44 protection nickelée / *nickel plating*

38 protection nickelée / *nickel plating*

42 protection cadmiée vert olive / *olive green cadmium plating*

Pour raccord à reprise de tresse T* & RT*

Backshell for screen termination, type T* & RT*] Voir page 12

] See page 12

66 version à sertir: livrée sans raccord, ni bague conique / *crimp version: delivered without backshell, nor conical ring*

version à souder: idem version à sertir + sans grommet / *solder version: idem crimp version + no grommet*

Q7 protection cadmiée vert olive, 500 heures brouillard salin - versions à sertir et à souder / *olive green cadmium plating, salt spray 500 hr - crimp and solder versions*

R3 protection cadmiée vert olive, 500 heures brouillard salin - versions à picots / *olive green cadmium plating, salt spray 500 hr - PC tail version*

G4 version à sertir: protection nickelée, livrée sans raccord, ni bague conique / *crimp version: nickel plating, delivered without backshell, nor conical ring*

version à souder: idem version à sertir + sans grommet / *solder version: idem crimp version + no grommet*



Types de raccord / Backshell types

à souder solder	à sertir crimp		à souder solder							à sertir crimp						
			00	01	07	06	08	36	76	00	01	07	06	08	36	76
E	R	raccord simple <i>backnut</i>	17	26	22	31	-	-	-	17	26	22	31	-	-	-
EC	RC	raccord droit à serre-câbles <i>straight cable clamp</i>	17	26	22	31	-	-	-	17	26	22	31	-	-	-
EC	RC	raccord coudé à serre-câbles <i>90° cable clamp</i>	-	-	-	-	35	-	-	-	-	-	-	35	-	-
AC		raccord droit à serre-câbles sans passe-fils <i>straight cable clamp without grommet</i>	17	26	22	31	-	-	-	-	-	-	-	-	-	-
P	RP	raccord droit pour potting <i>straight backshell for potting</i>	18	27	23	32	-	-	-	18	27	23	32	-	-	-
P	RP	raccord coudé pour potting <i>90° backshell for potting</i>	-	-	-	-	35	-	-	-	-	-	-	35	-	-
A	RA	raccord droit intermédiaire <i>straight adaptor</i>	18	27	-	32	-	36	-	18	27	-	32	-	36	-
T	RT	raccord droit pour gaine thermorétractable <i>straight backshell for heatshrink sleeving</i>	19	28	23	33	-	-	-	19	28	23	33	-	-	-
M	RM	raccord droit démontable pour gaine thermorétractable <i>straight removable backshell for heatshrink sleeving</i>	19	28	-	33	-	-	-	19	28	-	33	-	-	-
T*	RT*	raccord droit démontable pour reprise de tresse et gaine thermorétractable <i>straight removable backshell for screen termination and heatshrink sleeving</i> Pour spécif. 38 & 42 / <i>for specif. 38 & 42</i>	20	29	24	-	-	36	-	20	29	24	-	-	36	-
G	RG	raccord droit démontable pour reprise de tresse et gaine thermorétractable <i>straight removable backshell for screen termination and heatshrink sleeving</i>	20	29	24	-	-	37	-	20	29	24	-	-	37	-
J		raccord droit à presse-étoupe <i>straight backshell with sealing gland</i>	21	30	-	34	-	-	-	-	-	-	-	-	-	-
JC		raccord droit à presse-étoupe et serre-câbles <i>straight backshell with sealing gland and cable clamp</i>	21	30	-	34	-	-	-	-	-	-	-	-	-	-
U	RU	raccord droit court pour reprise de tresse et gaine thermorétractable <i>short backshell for screen termination and heatshrink sleeving</i>	-	-	-	-	-	-	38	-	-	-	-	-	-	38
Z	RZ	raccord droit intermédiaire pour adaptation de raccord au pas électrique <i>straight adaptor for electrical pitch access</i>	-	-	-	37	-	-	-	-	-	-	37	-	-	-

- Embases sans possibilité de raccord - 02E/02R/07A - voir page 25
 - Receptacle not accepting backshells - 02E/02R/07A - see page 25



851 Series

Références / Ordering Information

Connecteurs hermétiques / Hermetic connectors

Racine / Basic series	851	02H	8	3A	P	-	50	--
Type de boîtier / Shell type								
02H	embase à collerette carrée / square flange receptacle							
07H	embase à fixation par écrou / jam nut receptacle							
IH	embase à collerette ronde fixation par brasage / solder fixing receptacle							
Taille de boîtier / Shell size								
8 - 10 - 12 - 14 - 16 - 18 - 20 - 22 - 24								
Arrangements / Contact layouts								
Voir tableau page 14/15 - See table page 14/15								
Type de contact / Contact type								
P = mâle uniquement / male only								
Positionnement / Orientation								
normal (n'apparaît pas dans la référence) w, x, y, z - voir tableau page 16								
normal (not included in part number) w, x, y, z - see table page 16								
Indice obligatoire / Obligatory suffix								
50	Contacts #20 et # 16: dorés							
	Gold plating for size 20 and size 16							
Spécification / Specification								
sans spécification: 02H et 07H, protection cadmiée jaune / without specification: 02H and 07H, yellow cadmium plating								
	IH, protection nickelée / IH, nickel							
44	02H et 07H, protection nickelée / 02H and 07H, nickel							

Connecteurs à picots & connexions enroulées / PC tail & wire-wrap connectors

Racine / Basic series	851	02E	8	3A	P	-	50	16
Type de boîtier / Shell type								
02E	embase à collerette carrée sans possibilité de raccord							
	square flange receptacle not accepting backshell							
07A	embase à fixation par écrou sans possibilité de raccord							
	jam nut receptacle not accepting backshell							
Taille de boîtier / Shell size								
8 - 10 - 12 - 14 - 16 - 18 - 20 - 22 - 24								
Arrangements / Contact layouts								
Voir tableau page 14/15 - See table page 14/15								
Type de contact / Contact type								
P = mâle/male - S = femelle/female								
Positionnement / Orientation								
normal (n'apparaît pas dans la référence) w, x, y, z - voir tableau page 16								
normal (not included in part number) w, x, y, z - see table page 16								
Indice obligatoire / Obligatory suffix								
50	contacts à picots: taille 20, contacts dorés en partie active + étamés en partie arrière sauf arrangements 8-2, 8-3, 8-4 & 12-14; Taille 16, contacts dorés; Mixte taille 20 & 16, contacts dorés / PC tail contacts: size 20, contacts with gold plated active zone + tin plated termination area except 8-2, 8-3, 8-4 & 12-14 layouts; Size 16, gold plated contacts all over; Mix size 20 & 16, gold plated contacts all over							
51	contacts à picots taille 20: dorés / gold plating for PC tail contacts size 20							
54	protection zinc nickel noir (contacts: idem spécif.50) / black zinc nickel plating (contacts idem spécif.50)							
57	protection zinc nickel noir (contacts dorés: idem spécif.50) / black zinc nickel plating (gold plated contacts idem spécif.50)							
Spécification obligatoire / Obligatory specification								
à picot droit	16: corps cadmié vert olive	- contact Ø 1 mm, picot de Ø 0.6 mm / contact Ø 1.6 mm, picot de Ø 1 mm						
	45: corps nickelé	- contact Ø 1 mm, picot de Ø 0.6 mm / contact Ø 1.6 mm, picot de Ø 1 mm						
pour connexion enroulée	34: contacts démontables, corps cadmié vert olive (voir tableau page 10)							
	34A: contacts non démontables, corps cadmié vert olive							
PC tail	16: olive green cadmium plated body	- Ø 1 mm contact, Ø 0.6 mm terminal / Ø 1.6 mm contact, Ø 1 mm terminal						
	45: nickel plating	- Ø 1 mm contact, Ø 0.6 mm terminal / Ø 1.6 mm contact, Ø 1 mm terminal						
wire-wrap	34: non-banded contacts, olive green cadmium plated shell (see table, page 10)							
	34A: banded contacts, olive green cadmium plated							



851 Series

Arrangements / Contact layouts

Vue de face avant isolant mâle / Viewed from front face of male insulator

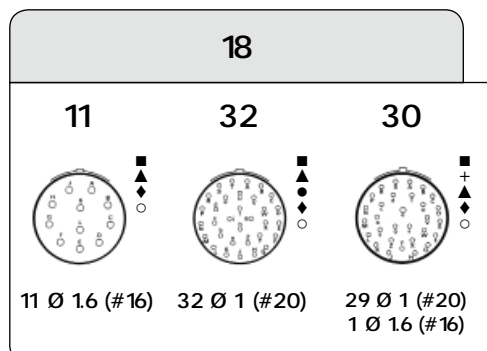
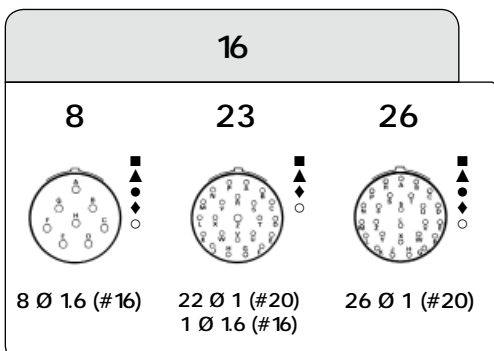



851 Series

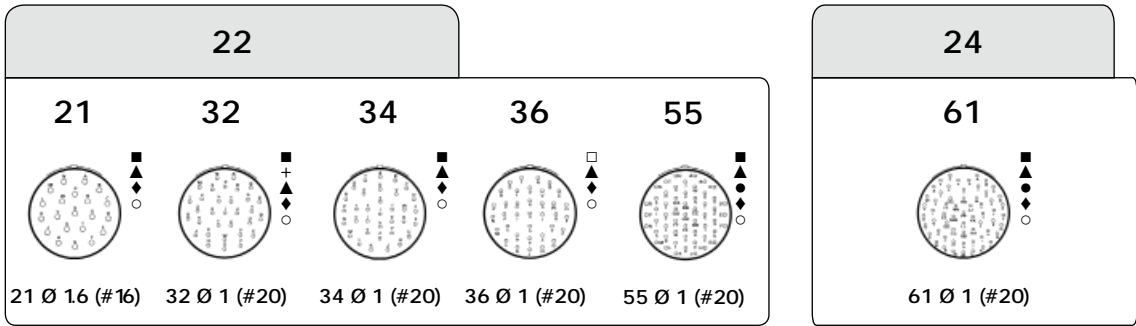

- Arrangements contacts à souder (QPL) / *Solder contact layouts (QPL)*
- Arrangements contacts à souder / *Solder contact layouts*
- + Arrangements contacts à souder sans possibilité de passe-fils / *Solder contact layouts without grommet*
- ▲ Arrangements contacts à sertir / *Crimp contact layouts*
- Arrangements version hermétique / *Hermetic version contact layouts*
- ◆ Arrangements contacts à picots / *PC tail contact layouts*
- Arrangements contacts pour connexions enroulées / *Wire-wrap contact layouts*
- * Version à sertir avec clip de retention n'existe pas / *Crimp version do not exist with retention clip*

Autres arrangements, nous consulter / *Other layouts, please consult us*



851 Series

Positionnements / Orientations

Isolant tournant à l'intérieur du corps métallique / Insulator rotated inside metal body

Vue face avant isolant mâle (corps d'embase ou corps de fiche) / Viewed from front face of male insulator (receptacle or plug)

boîtiers shells	arrange-ments layouts	angles en degrés / angle in degrees				NFC 93422 HE 301B		MIL-DTL-26482G serie 1		service1 1500 Veff 1500 Vrms	service 2 2300 Veff 2300 Vrms
		W	X	Y	Z	souder solder	sertir crimp	souder solder	sertir crimp		
8	2	58	122	-	-			•		X	
	3	60	210	-	-			•		X	
	3A (98)*	60	210	-	-			•	•	X	
	4	45	-	-	-			•		X	
	33	90	-	-	-		•	•	•	X	
10	6	90	-	-	-	•	•	•	•	X	
	7*	90	-	-	-					X	
	98	90	180	240	270			•	•	X	
12	3	-	-	180	-	•	•	•	•		X
	8	90	112	203	292			•	•	X	
	10	60	155	270	295	•	•	•	•	X	
	2	-	-	-	-						X
14	14*	45						•		X	
	5	40	92	184	273	•	•	•	•		X
	12	43	90	-	-	•	•	•	•	X	
	15	17	110	155	234	•	•	•	•	X	
	18	15	90	180	270			•	•	X	
16	19	30	165	315	-	•	•	•	•	X	
	8	54	152	180	331	•	•	•	•		X
	23	158	270	-	-	•	•	•	•	X	
18	26	60	-	275	338	•	•	•	•	X	
	11	62	119	241	340	•	•	•	•		X
	32	85	138	222	265	•	•	•	•	X	
20	30	180	193	285	350		•		•	X	
	16	238	318	333	347	•	•	•	•		X
	39	63	144	252	333	•	•	•	•	X	
	41	45	126	225	-	•	•	•	•	X	
	24	70	145	215	290			•	•	X	
	25	72	144	216	288					X	
22	27	72	144	216	288		•		•	X	
	21	16	135	175	349	•	•	•	•		X
	36	72	144	216	288		•			X	
	55	30	142	226	314	•	•	•	•	X	
	32	72	145	215	288				•	X	
24	34	62	142	218	298				•	X	
	61	90	180	270	324	•	•	•	•	X	

* Arrangement 8-98 : positionnements W et X non normalisés / 8-98 layout, W and X non standard orientations
 Arrangements 10-7 & 12-14 : positionnement W non normalisé / 10-7 & 12-14 layouts, W non standard orientation

851 Series



Encombrements / Dimensions

Embase à collerette carrée avec raccord simple Square flange receptacle with backnut

00 E	HE 301 B 00 E
	MS 3110 E
00 R	HE 301 B 00 R
	MS 3120 E
	VG 95328 A

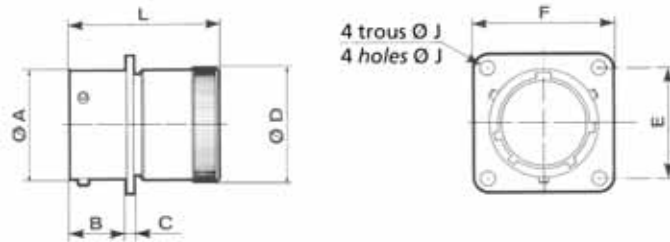

Taille de boîtier Shell size	Références / Part numbers		L max		A	B max	C max	D max	E	F max	J
	contacts à souder solder contacts	contacts à sertir crimp contacts	souder solder	sertir crimp							
8	851 00 E 8.. P _S . 50..	851 00 R 8.. P _S . 50..	32.70	32.00	12.03	11.70	1.32	13.50	15.09	20.99	3.13
10	851 00 E 10.. P _S . 50..	851 00 R 10.. P _S . 50..	32.70	32.00	15.01	11.70	1.32	16.70	18.26	24.19	3.13
12	851 00 E 12.. P _S . 50..	851 00 R 12.. P _S . 50..	32.70	32.00	19.07	11.70	1.32	19.90	20.62	26.54	3.13
14	851 00 E 14.. P _S . 50..	851 00 R 14.. P _S . 50..	32.70	32.00	22.25	11.70	1.32	23.40	23.00	28.89	3.13
16	851 00 E 16.. P _S . 50..	851 00 R 16.. P _S . 50..	32.70	32.00	25.42	11.70	1.32	26.60	24.61	31.29	3.13
18	851 00 E 18.. P _S . 50..	851 00 R 18.. P _S . 50..	32.70	32.00	28.60	11.70	1.32	29.50	26.97	33.69	3.13
20	851 00 E 20.. P _S . 50..	851 00 R 20.. P _S . 50..	34.50	33.40	31.77	14.35	2.15	32.70	29.36	36.89	3.13
22	851 00 E 22.. P _S . 50..	851 00 R 22.. P _S . 50..	34.50	33.40	34.95	14.35	2.15	36.00	31.75	39.99	3.13
24	851 00 E 24.. P _S . 50..	851 00 R 24.. P _S . 50..	34.50	33.40	38.12	15.20	2.15	39.10	34.92	43.15	3.81

Embase à collerette carrée avec raccord droit à serre-câbles Square flange receptacle with straight cable clamp backshell

00 EC	HE 301 B 00 EC
	MS 3110 F
00 AC	HE 301 B 00 AC
00 RC	HE 301 B 00 RC
	MS 3120 F
	VG 95328 B

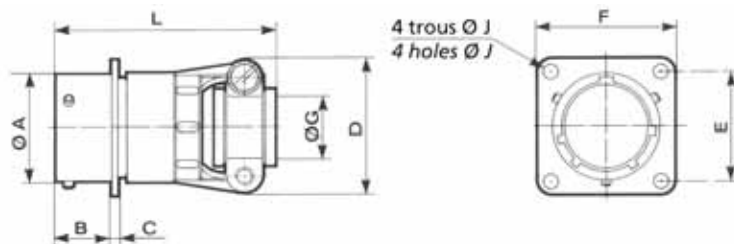

Taille de boîtier Shell size	Références / Part numbers		L max		A	B max	C max	D max	E	F max	G	J
	contacts à souder solder contacts	contacts à sertir crimp contacts	souder solder	sertir crimp								
8	851 00 ^{EC} _{AC} 8.. P _S . 50..	851 00 RC 8.. P _S . 50 ..	48.00	47.30	12.03	11.70	1.32	19.90	15.09	20.99	3.50	3.13
10	851 00 ^{EC} _{AC} 10.. P _S . 50..	851 00 RC 10.. P _S . 50..	48.00	47.30	15.01	11.70	1.32	21.50	18.26	24.19	5.00	3.13
12	851 00 ^{EC} _{AC} 12.. P _S . 50..	851 00 RC 12.. P _S . 50..	48.00	47.30	19.07	11.70	1.32	25.00	20.62	26.54	8.20	3.13
14	851 00 ^{EC} _{AC} 14.. P _S . 50..	851 00 RC 14.. P _S . 50..	48.00	47.30	22.25	11.70	1.32	27.80	23.00	28.89	10.00	3.13
16	851 00 ^{EC} _{AC} 16.. P _S . 50..	851 00 RC 16.. P _S . 50..	51.00	50.50	25.42	11.70	1.32	29.40	24.61	31.29	13.00	3.13
18	851 00 ^{EC} _{AC} 18.. P _S . 50..	851 00 RC 18.. P _S . 50..	51.00	50.50	28.60	11.70	1.32	35.30	26.97	33.69	16.00	3.13
20	851 00 ^{EC} _{AC} 20.. P _S . 50..	851 00 RC 20.. P _S . 50..	53.00	51.50	31.77	14.35	2.15	35.30	29.36	36.89	16.00	3.13
22	851 00 ^{EC} _{AC} 22.. P _S . 50..	851 00 RC 22.. P _S . 50..	53.00	51.50	34.95	14.35	2.15	41.10	31.75	39.99	19.30	3.13
24	851 00 ^{EC} _{AC} 24.. P _S . 50..	851 00 RC 24.. P _S . 50..	53.00	51.50	38.12	15.20	2.15	42.40	34.92	43.15	20.60	3.81

Note : toutes les dimensions sont en mm / all dimensions are in mm

851 Series



Embase à collerette carrée avec raccord droit pour potting Square flange receptacle with straight backshell for potting

00 P	HE 301 B 00 P
	MS 3110 P
00 RP	HE 301 B 00 RP
	MS 3120 P



Taille de boîtier Shell size	Références / Part numbers		L max		A	B max	C max	D max	E	F max	G max	J
	contacts à souder solder contacts	contacts à sertir crimp contacts	souder solder	sertir crimp								
8	851 00 P 8.. $\frac{P}{S} . 50..$	851 00 RP 8.. $\frac{P}{S} . 50..$	36.20	41.70	12.03	11.70	1.32	15.34	15.09	20.99	10.46	3.13
10	851 00 P 10.. $\frac{P}{S} . 50..$	851 00 RP 10.. $\frac{P}{S} . 50..$	36.20	41.70	15.01	11.70	1.32	17.70	18.26	24.19	13.55	3.13
12	851 00 P 12.. $\frac{P}{S} . 50..$	851 00 RP 12.. $\frac{P}{S} . 50..$	36.20	41.70	19.07	11.70	1.32	21.69	20.62	26.54	13.96	3.13
14	851 00 P 14.. $\frac{P}{S} . 50..$	851 00 RP 14.. $\frac{P}{S} . 50..$	36.20	41.70	22.25	11.70	1.32	23.90	23.00	28.89	17.42	3.13
16	851 00 P 16.. $\frac{P}{S} . 50..$	851 00 RP 16.. $\frac{P}{S} . 50..$	36.20	41.70	25.42	11.70	1.32	27.00	24.61	31.29	20.56	3.13
18	851 00 P 18.. $\frac{P}{S} . 50..$	851 00 RP 18.. $\frac{P}{S} . 50..$	36.91	44.46	28.60	11.70	1.32	30.50	26.97	33.69	23.66	3.13
20	851 00 P 20.. $\frac{P}{S} . 50..$	851 00 RP 20.. $\frac{P}{S} . 50..$	43.80	50.93	31.77	14.35	2.15	33.65	29.36	36.89	23.92	3.13
22	851 00 P 22.. $\frac{P}{S} . 50..$	851 00 RP 22.. $\frac{P}{S} . 50..$	43.80	50.93	34.95	14.35	2.15	37.10	31.75	39.99	25.52	3.13
24	851 00 P 24.. $\frac{P}{S} . 50..$	851 00 RP 24.. $\frac{P}{S} . 50..$	43.80	51.40	38.12	15.20	2.15	40.00	34.92	43.15	32.00	3.81

Embase à collerette carrée avec raccord droit intermédiaire Square flange receptacle with straight adaptor

00 A	HE 301 B 00 A
00 RA	HE 301 B 00 RA

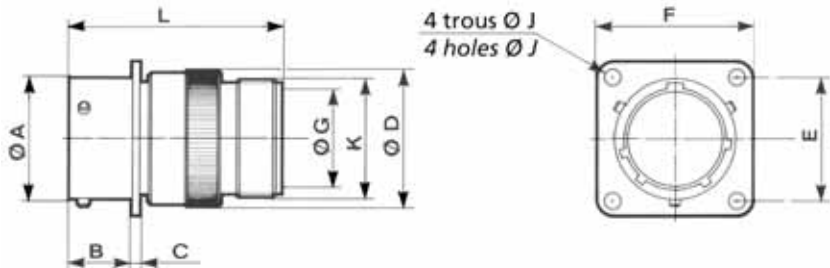

Taille de boîtier Shell size	Références / Part numbers		L max		A	B max	C max	D max	E	F max	G max	J	K filletage threading UNEF 2A
	contacts à souder solder contacts	contacts à sertir crimp contacts	souder solder	sertir crimp									
8	851 00 A 8.. $\frac{P}{S} . 50..$	851 00 RA 8.. $\frac{P}{S} . 50..$	41.00		12.03	11.70	1.32	14.50	15.09	20.99	9.10	3.13	1/2 18
10	851 00 A 10.. $\frac{P}{S} . 50..$	851 00 RA 10.. $\frac{P}{S} . 50..$	41.00		15.01	11.70	1.32	18.70	18.26	24.19	12.08	3.13	5/8 24
12	851 00 A 12.. $\frac{P}{S} . 50..$	851 00 RA 12.. $\frac{P}{S} . 50..$	41.00		19.07	11.70	1.32	21.70	20.62	26.54	15.25	3.13	3/4 20
14	851 00 A 14.. $\frac{P}{S} . 50..$	851 00 RA 14.. $\frac{P}{S} . 50..$	41.00		22.25	11.70	1.32	25.10	23.00	28.89	18.15	3.13	7/8 20
16	851 00 A 16.. $\frac{P}{S} . 50..$	851 00 RA 16.. $\frac{P}{S} . 50..$	41.00		25.42	11.70	1.32	28.13	24.61	31.29	21.32	3.13	1-20
18	851 00 A 18.. $\frac{P}{S} . 50..$	851 00 RA 18.. $\frac{P}{S} . 50..$	41.00		28.60	11.70	1.32	31.38	26.97	33.69	24.32	3.13	1-3/16 18
20	851 00 A 20.. $\frac{P}{S} . 50..$	851 00 RA 20.. $\frac{P}{S} . 50..$	44.00		31.77	14.35	2.15	34.30	29.36	36.89	26.73	3.13	1-3/16 18
22	851 00 A 22.. $\frac{P}{S} . 50..$	851 00 RA 22.. $\frac{P}{S} . 50..$	44.00		34.95	14.35	2.15	37.60	31.75	39.99	30.67	3.13	1-7/16 18
24	851 00 A 24.. $\frac{P}{S} . 50..$	851 00 RA 24.. $\frac{P}{S} . 50..$	44.00		38.12	15.20	2.15	40.70	34.92	43.15	33.08	3.81	1-7/16 18

Note : toutes les dimensions sont en mm / all dimensions are in mm

851 Series



Embase à collerette carrée avec raccord pour gaine thermorétractable Square flange receptacle with straight backshell for heatshrink sleeving

OO T	
OO RT	

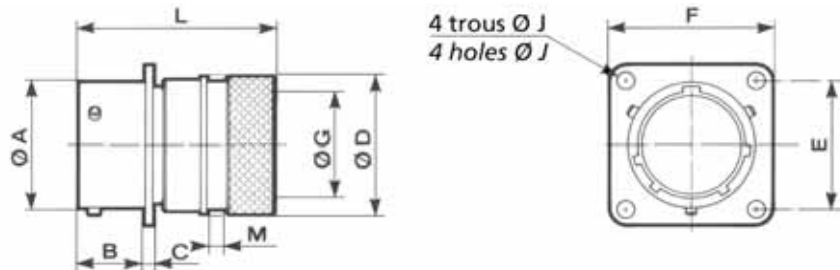

Taille de boîtier Shell size	Références / Part numbers		L max		A	B max	C max	D max	E	F max	G max		J	M max
	contacts à souder solder contacts	contacts à sertir crimp contacts	souder solder	sertir crimp							souder solder	sertir crimp		
8	851 00 T 8.. ^P / _S . 50..	851 00 RT 8.. ^P / _S . 50 ..	36.70	36.00	12.03	11.70	1.32	15.35	15.09	20.99	7.20	6.70	3.13	3.70
10	851 00 T 10.. ^P / _S . 50..	851 00 RT 10.. ^P / _S . 50..	36.70	36.00	15.01	11.70	1.32	18.15	18.26	24.19	10.20	9.40	3.13	3.70
12	851 00 T 12.. ^P / _S . 50..	851 00 RT 12.. ^P / _S . 50..	36.70	36.00	19.07	11.70	1.32	23.45	20.62	26.54	13.20	11.95	3.13	3.70
14	851 00 T 14.. ^P / _S . 50..	851 00 RT 14.. ^P / _S . 50..	36.70	36.00	22.25	11.70	1.32	24.25	23.00	28.89	16.10	15.15	3.13	3.70
16	851 00 T 16.. ^P / _S . 50..	851 00 RT 16.. ^P / _S . 50..	39.00	38.30	25.42	11.70	1.32	29.55	24.61	31.29	19.25	18.05	3.13	3.70
18	851 00 T 18.. ^P / _S . 50..	851 00 RT 18.. ^P / _S . 50..	39.00	38.30	28.60	11.70	1.32	31.75	26.97	33.69	21.30	19.95	3.13	3.70
20	851 00 T 20.. ^P / _S . 50..	851 00 RT 20.. ^P / _S . 50..	45.30	44.20	31.77	14.35	2.15	35.85	29.36	36.89	24.40	23.05	3.13	3.70
22	851 00 T 22.. ^P / _S . 50..	851 00 RT 22.. ^P / _S . 50..	45.30	44.20	34.95	14.35	2.15	38.20	31.75	39.99	27.50	25.55	3.13	3.70
24	851 00 T 24.. ^P / _S . 50..	851 00 RT 24.. ^P / _S . 50..	44.00	42.60	38.12	15.20	2.15	41.30	34.92	43.15	30.60	28.65	3.81	3.70

Embase à collerette carrée avec raccord droit démontable pour gaine thermorétractable Square flange receptacle with removable straight backshell for heatshrink sleeving

OO M	
OO RM	

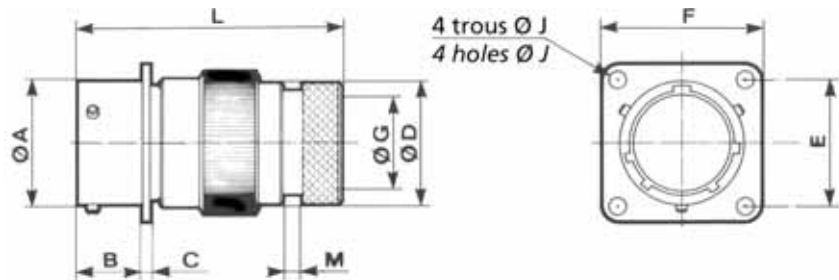

Taille de boîtier Shell size	Références / Part numbers		L max		A	B max	C max	D max	E	F max	G max	J	M max
	contacts à souder solder contacts	contacts à sertir crimp contacts	souder solder	sertir crimp									
8	851 00 M 8.. ^P / _S . 50..	851 00 RM 8.. ^P / _S . 50 ..	50.00		12.03	11.70	1.32	13.55	15.09	20.99	7.05	3.13	3.50
10	851 00 M 10.. ^P / _S . 50..	851 00 RM 10.. ^P / _S . 50..	50.00		15.01	11.70	1.32	15.35	18.26	24.19	9.90	3.13	3.50
12	851 00 M 12.. ^P / _S . 50..	851 00 RM 12.. ^P / _S . 50..	50.00		19.07	11.70	1.32	19.48	20.62	26.54	12.60	3.13	3.50
14	851 00 M 14.. ^P / _S . 50..	851 00 RM 14.. ^P / _S . 50..	50.00		22.25	11.70	1.32	21.30	23.00	28.89	15.90	3.13	3.50
16	851 00 M 16.. ^P / _S . 50..	851 00 RM 16.. ^P / _S . 50..	50.00		25.42	11.70	1.32	24.50	24.61	31.29	18.95	3.13	3.50
18	851 00 M 18.. ^P / _S . 50..	851 00 RM 18.. ^P / _S . 50..	50.00		28.60	11.70	1.32	26.45	26.97	33.69	20.90	3.13	3.50
20	851 00 M 20.. ^P / _S . 50..	851 00 RM 20.. ^P / _S . 50..	53.30		31.77	14.35	2.15	30.73	29.36	36.89	23.70	3.13	3.50
22	851 00 M 22.. ^P / _S . 50..	851 00 RM 22.. ^P / _S . 50..	53.30		34.95	14.35	2.15	34.24	31.75	39.99	26.60	3.13	3.50
24	851 00 M 24.. ^P / _S . 50..	851 00 RM 24.. ^P / _S . 50..	53.30		38.12	15.20	2.15	36.47	34.92	43.15	29.30	3.81	3.50

Note : toutes les dimensions sont en mm / all dimensions are in mm

851 Series



Embase à collerette carrée avec raccord droit démontable pour reprise de tresse et gaine thermorétractable (spécifications 38 & 42) / Square flange receptacle with removable backshell for screen termination and heatshrink sleeving (38 & 42 suffix)

00 T	
00 RT	

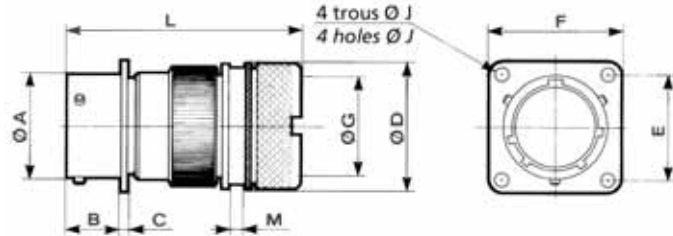

Taille de boîtier Shell size	Références / Part numbers		L max		A	B max	C max	D max	E	F max	G max	J	M max
	contacts à souder solder contacts	contacts à sertir crimp contacts	souder solder	sertir crimp									
8	851 00 T 8.. P _S . 50 ³⁸ / ₄₂	851 00 RT 8.. P _S . 50 ³⁸ / ₄₂	51.60		12.03	11.70	1.32	18.25	15.09	20.99	7.45	3.13	3.70
10	851 00 T 10.. P _S . 50 ³⁸ / ₄₂	851 00 RT 10.. P _S . 50 ³⁸ / ₄₂	51.60		15.01	11.70	1.32	20.25	18.26	24.19	9.00	3.13	3.70
12	851 00 T 12.. P _S . 50 ³⁸ / ₄₂	851 00 RT 12.. P _S . 50 ³⁸ / ₄₂	51.60		19.07	11.70	1.32	24.75	20.62	26.54	13.30	3.13	3.70
14	851 00 T 14.. P _S . 50 ³⁸ / ₄₂	851 00 RT 14.. P _S . 50 ³⁸ / ₄₂	51.60		22.25	11.70	1.32	27.75	23.00	28.89	16.50	3.13	3.70
16	851 00 T 16.. P _S . 50 ³⁸ / ₄₂	851 00 RT 16.. P _S . 50 ³⁸ / ₄₂	51.60		25.42	11.70	1.32	30.05	24.61	31.29	18.50	3.13	3.70
18	851 00 T 18.. P _S . 50 ³⁸ / ₄₂	851 00 RT 18.. P _S . 50 ³⁸ / ₄₂	52.00		28.60	11.70	1.32	34.15	26.97	33.69	21.90	3.13	3.70
20	851 00 T 20.. P _S . 50 ³⁸ / ₄₂	851 00 RT 20.. P _S . 50 ³⁸ / ₄₂	55.10		31.77	14.35	2.15	37.25	29.36	36.89	25.10	3.13	3.70
22	851 00 T 22.. P _S . 50 ³⁸ / ₄₂	851 00 RT 22.. P _S . 50 ³⁸ / ₄₂	55.10		34.95	14.35	2.15	40.45	31.75	39.99	28.20	3.13	3.70
24	851 00 T 24.. P _S . 50 ³⁸ / ₄₂	851 00 RT 24.. P _S . 50 ³⁸ / ₄₂	55.10		38.12	15.20	2.15	43.65	34.92	43.15	31.40	3.81	3.70

Embase à collerette carrée avec raccord droit démontable pour reprise de tresse et gaine thermorétractable / Square flange receptacle with removable straight backshell for screen termination and heatshrink sleeving

00 G	
00 RG	VG 95328 R

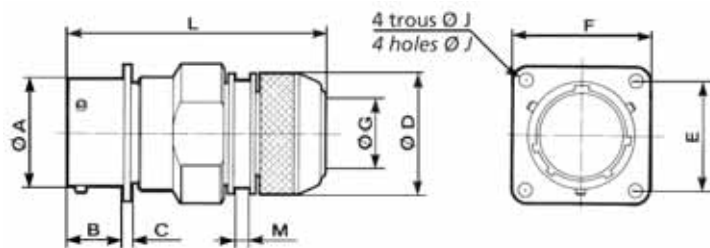

Taille de boîtier Shell size	Références / Part numbers		L max		A	B max	C max	D max	E	F max	G max	J	M max
	contacts à souder solder contacts	contacts à sertir crimp contacts	souder solder	sertir crimp									
8	851 00 G 8.. P _S . 50..	851 00 RG 8.. P _S . 50 ..	54.00		12.03	11.70	1.32	16.30	15.09	20.99	7.45	3.13	3.60
10	851 00 G 10.. P _S . 50..	851 00 RG 10.. P _S . 50..	54.00		15.01	11.70	1.32	18.30	18.26	24.19	10.30	3.13	3.60
12	851 00 G 12.. P _S . 50..	851 00 RG 12.. P _S . 50..	54.00		19.07	11.70	1.32	22.30	20.62	26.54	13.20	3.13	3.60
14	851 00 G 14.. P _S . 50..	851 00 RG 14.. P _S . 50..	54.00		22.25	11.70	1.32	25.30	23.00	28.89	16.50	3.13	3.60
16	851 00 G 16.. P _S . 50..	851 00 RG 16.. P _S . 50..	54.00		25.42	11.70	1.32	28.30	24.61	31.29	19.35	3.13	3.60
18	851 00 G 18.. P _S . 50..	851 00 RG 18.. P _S . 50..	54.00		28.60	11.70	1.32	32.30	26.97	33.69	21.60	3.13	3.60
20	851 00 G 20.. P _S . 50..	851 00 RG 20.. P _S . 50..	59.30		31.77	14.35	2.15	34.30	29.36	36.89	24.80	3.13	3.60
22	851 00 G 22.. P _S . 50..	851 00 RG 22.. P _S . 50..	59.30		34.95	14.35	2.15	38.30	31.75	39.99	27.90	3.13	3.60
24	851 00 G 24.. P _S . 50..	851 00 RG 24.. P _S . 50..	59.30		38.12	15.20	2.15	41.30	34.92	43.15	31.00	3.81	3.60

Note : toutes les dimensions sont en mm / all dimensions are in mm

851 Series



Embase à collerette carrée avec raccord droit presse-étoupe Square flange receptacle with straight sealing gland backshell

00 J HE 301 B 00J



Taille de boîtier Shell size	Références / Part numbers		L max		A	B max	C max	D max	E	F max	G		J
	contacts à souder solder contacts	contacts à sertir crimp contacts	souder solder	sertir crimp							min	max	
8	851 00 J 8.. $\frac{P}{S}$.50..	-	47.60	-	12.03	11.70	1.32	14.40	15.09	20.99	5.02	5.84	3.13
10	851 00 J 10.. $\frac{P}{S}$.50..	-	47.60	-	15.01	11.70	1.32	17.60	18.26	24.19	5.94	6.76	3.13
12	851 00 J 12.. $\frac{P}{S}$.50..	-	48.70	-	19.07	11.70	1.32	21.10	20.62	26.54	9.34	10.16	3.13
14	851 00 J 14.. $\frac{P}{S}$.50..	-	53.50	-	22.25	11.70	1.32	24.40	23.00	28.89	11.32	12.14	3.13
16	851 00 J 16.. $\frac{P}{S}$.50..	-	59.00	-	25.42	11.70	1.32	27.60	24.61	31.29	14.73	15.55	3.13
18	851 00 J 18.. $\frac{P}{S}$.50..	-	65.00	-	28.60	11.70	1.32	30.80	26.97	33.69	16.00	16.82	3.13
20	851 00 J 20.. $\frac{P}{S}$.50..	-	79.10	-	31.77	14.35	2.15	34.10	29.36	36.89	16.89	17.70	3.13
22	851 00 J 22.. $\frac{P}{S}$.50..	-	80.00	-	34.95	14.35	2.15	37.30	31.75	39.99	17.78	18.60	3.13
24	851 00 J 24.. $\frac{P}{S}$.50..	-	90.00	-	38.12	15.20	2.15	40.50	34.92	43.15	20.34	21.16	3.81

Embase à collerette carrée avec raccord droit à presse-étoupe et serre-câbles Square flange receptacle with straight sealing gland and cable clamp

00 JC MS 3110 J



Taille de boîtier Shell size	Références / Part numbers		L max		A	B max	C max	D max	E	F max	G		J
	contacts à souder solder contacts	contacts à sertir crimp contacts	souder solder	sertir crimp							min	max	
8	851 00 JC 8.. $\frac{P}{S}$.50..	-	57.68	-	12.03	11.70	1.32	19.90	15.09	20.99	5.02	5.84	3.13
10	851 00 JC 10.. $\frac{P}{S}$.50..	-	57.68	-	15.01	11.70	1.32	21.50	18.26	24.19	5.94	6.76	3.13
12	851 00 JC 12.. $\frac{P}{S}$.50..	-	61.24	-	19.07	11.70	1.32	25.00	20.62	26.54	9.34	10.16	3.13
14	851 00 JC 14.. $\frac{P}{S}$.50..	-	66.01	-	22.25	11.70	1.32	27.80	23.00	28.89	11.32	12.14	3.13
16	851 00 JC 16.. $\frac{P}{S}$.50..	-	74.75	-	25.42	11.70	1.32	29.40	24.61	31.29	14.73	15.55	3.13
18	851 00 JC 18.. $\frac{P}{S}$.50..	-	80.57	-	28.60	11.70	1.32	35.30	26.97	33.69	16.00	16.82	3.13
20	851 00 JC 20.. $\frac{P}{S}$.50..	-	91.69	-	31.77	14.35	2.15	35.30	29.36	36.89	16.89	17.70	3.13
22	851 00 JC 22.. $\frac{P}{S}$.50..	-	95.66	-	34.95	14.35	2.15	41.10	31.75	39.99	17.78	18.60	3.13
24	851 00 JC 24.. $\frac{P}{S}$.50..	-	101.22	-	38.12	15.20	2.15	42.40	34.92	43.15	20.34	21.16	3.81

Note : toutes les dimensions sont en mm / all dimensions are in mm

851 Series

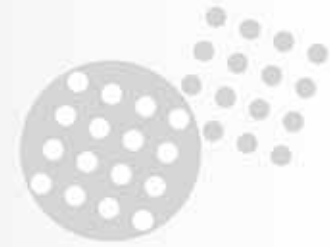

Embase à fixation par écrou avec raccord simple Jam nut receptacle with backnut

07 E	HE 301 B 07 E
	MS 3114 E
07 R	HE 301 B 07 R
	MS 3124 E
	VG 95328 D

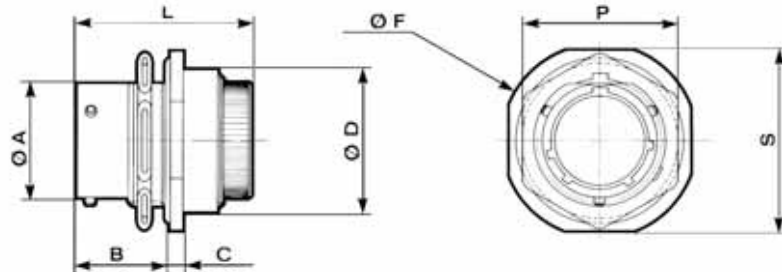

Taille de boîtier Shell size	Références / Part numbers		L max		A	B max	C max	D max	F max	P max	S max
	contacts à souder solder contacts	contacts à sertir crimp contacts	souder solder	sertir crimp							
8	851 07 E 8.. P _S . 50..	851 07 R 8.. P _S . 50 ..	34.10	33.50	12.03	17.90	2.64	18.50	26.94	19.29	23.94
10	851 07 E 10.. P _S . 50..	851 07 R 10.. P _S . 50..	34.10	33.50	15.01	17.90	2.64	21.70	30.14	22.38	26.94
12	851 07 E 12.. P _S . 50..	851 07 R 12.. P _S . 50..	34.10	33.50	19.07	17.90	2.64	24.90	34.94	27.13	31.74
14	851 07 E 14.. P _S . 50..	851 07 R 14.. P _S . 50..	34.10	33.50	22.25	17.90	2.64	28.10	38.04	30.33	34.94
16	851 07 E 16.. P _S . 50..	851 07 R 16.. P _S . 50..	34.10	33.50	25.42	17.90	2.64	31.20	41.24	33.48	38.24
18	851 07 E 18.. P _S . 50..	851 07 R 18.. P _S . 50..	34.10	33.50	28.60	17.90	2.64	34.40	44.44	36.68	41.34
20	851 07 E 20.. P _S . 50..	851 07 R 20.. P _S . 50..	39.30	37.90	31.77	22.45	3.44	38.30	49.14	39.83	46.04
22	851 07 E 22.. P _S . 50..	851 07 R 22.. P _S . 50..	39.30	37.90	34.95	22.45	3.44	41.50	52.24	43.03	49.24
24	851 07 E 24.. P _S . 50..	851 07 R 24.. P _S . 50..	39.30	37.90	38.12	22.30	3.44	44.70	55.54	46.18	52.74

Embase à fixation par écrou avec raccord droit à serre-câbles Jam nut receptacle with straight cable clamp

07 EC	HE 301 B 07 EC
	MS 3114 F
07 AC	HE 301 B 07 AC
07 RC	HE 301 B 07 RC
	MS 3124 F
	VG 95328 E



Taille de boîtier Shell size	Références / Part numbers		L max		A	B max	C max	D max	F max	G	P max	S max
	contacts à souder solder contacts	contacts à sertir crimp contacts	souder solder	sertir crimp								
8	851 07 EC 8.. P _S . 50..	851 07 RC 8.. P _S . 50 ..	49.31	49.10	12.03	17.90	2.64	19.90	26.94	3.50	19.29	23.94
10	851 07 EC 10.. P _S . 50..	851 07 RC 10.. P _S . 50..	49.31	49.10	15.01	17.90	2.64	21.50	30.14	5.00	22.38	26.94
12	851 07 EC 12.. P _S . 50..	851 07 RC 12.. P _S . 50..	49.17	49.10	19.07	17.90	2.64	25.00	34.94	8.20	27.13	31.74
14	851 07 EC 14.. P _S . 50..	851 07 RC 14.. P _S . 50..	49.17	49.10	22.25	17.90	2.64	27.80	38.04	10.00	30.33	34.94
16	851 07 EC 16.. P _S . 50..	851 07 RC 16.. P _S . 50..	52.34	52.20	25.42	17.90	2.64	29.40	41.24	13.00	33.48	38.24
18	851 07 EC 18.. P _S . 50..	851 07 RC 18.. P _S . 50..	53.22	53.10	28.60	17.90	2.64	35.30	44.44	16.00	36.68	41.34
20	851 07 EC 20.. P _S . 50..	851 07 RC 20.. P _S . 50..	58.10	58.00	31.77	22.45	3.44	35.30	49.14	16.00	39.83	46.04
22	851 07 EC 22.. P _S . 50..	851 07 RC 22.. P _S . 50..	58.10	58.00	34.95	22.45	3.44	41.10	52.24	19.30	43.03	49.24
24	851 07 EC 24.. P _S . 50..	851 07 RC 24.. P _S . 50..	58.10	58.00	38.12	23.30	3.44	42.40	55.54	20.60	46.18	52.74

Note : toutes les dimensions sont en mm / all dimensions are in mm

851 Series



Embase à fixation par écrou avec raccord droit pour potting Jam nut receptacle with straight backshell for potting

07 P	HE 301 B 07 P MS 3114 P
07 RP	HE 301 B 07 RP MS 3124 P



Taille de boîtier Shell size	Références / Part numbers		L max		A	B max	C max	D max	F max	G max	P max	S max
	contacts à souder solder contacts	contacts à sertir crimp contacts	souder solder	sertir crimp								
8	851 07 P 8.. $\frac{P}{S}$. 50..	851 07 RP 8.. $\frac{P}{S}$. 50..	34.30	39.80	12.03	17.90	2.64	15.34	26.94	10.46	19.29	23.94
10	851 07 P 10.. $\frac{P}{S}$. 50..	851 07 RP 10.. $\frac{P}{S}$. 50..	34.30	39.80	15.01	17.90	2.64	17.70	30.14	13.55	22.38	26.94
12	851 07 P 12.. $\frac{P}{S}$. 50..	851 07 RP 12.. $\frac{P}{S}$. 50..	34.30	39.80	19.07	17.90	2.64	21.69	34.94	13.96	27.13	31.74
14	851 07 P 14.. $\frac{P}{S}$. 50..	851 07 RP 14.. $\frac{P}{S}$. 50..	34.30	39.80	22.25	17.90	2.64	23.90	38.04	17.42	30.33	34.94
16	851 07 P 16.. $\frac{P}{S}$. 50..	851 07 RP 16.. $\frac{P}{S}$. 50..	34.30	39.80	25.42	17.90	2.64	27.00	41.24	20.56	33.48	38.24
18	851 07 P 18.. $\frac{P}{S}$. 50..	851 07 RP 18.. $\frac{P}{S}$. 50..	34.10	41.80	28.60	17.90	2.64	30.50	44.44	23.66	36.68	41.34
20	851 07 P 20.. $\frac{P}{S}$. 50..	851 07 RP 20.. $\frac{P}{S}$. 50..	42.25	49.92	31.77	22.45	3.44	33.65	49.14	23.92	39.83	46.04
22	851 07 P 22.. $\frac{P}{S}$. 50..	851 07 RP 22.. $\frac{P}{S}$. 50..	42.25	49.92	34.95	22.45	3.44	37.10	52.24	25.52	43.03	49.24
24	851 07 P 24.. $\frac{P}{S}$. 50..	851 07 RP 24.. $\frac{P}{S}$. 50..	43.26	51.30	38.12	23.30	3.44	40.00	55.54	32.00	46.18	52.74

Embase à fixation par écrou avec raccord droit pour gaine thermorétractable Jam nut receptacle with straight backshell for heatshrink sleeve

07 T	
07 RT	VG 95328 S



Taille de boîtier Shell size	Références / Part numbers		L max		A	B max	C max	D max	F max	G max		M max	P max	S max
	contacts à souder solder contacts	contacts à sertir crimp contacts	souder solder	sertir crimp						souder solder	sertir crimp			
8	851 07 T 8.. $\frac{P}{S}$. 50..	851 07 RT 8.. $\frac{P}{S}$. 50..	42.60	41.50	12.03	17.90	2.64	15.35	26.94	7.20	6.70	3.70	19.29	23.94
10	851 07 T 10.. $\frac{P}{S}$. 50..	851 07 RT 10.. $\frac{P}{S}$. 50..	42.60	41.50	15.01	17.90	2.64	18.15	30.14	10.20	9.40	3.70	22.38	26.94
12	851 07 T 12.. $\frac{P}{S}$. 50..	851 07 RT 12.. $\frac{P}{S}$. 50..	42.60	41.50	19.07	17.90	2.64	23.45	34.94	13.20	11.95	3.70	27.13	31.74
14	851 07 T 14.. $\frac{P}{S}$. 50..	851 07 RT 14.. $\frac{P}{S}$. 50..	42.60	41.50	22.25	17.90	2.64	24.25	38.04	16.10	15.15	3.70	30.33	34.94
16	851 07 T 16.. $\frac{P}{S}$. 50..	851 07 RT 16.. $\frac{P}{S}$. 50..	44.40	43.80	25.42	17.90	2.64	29.55	41.24	19.25	18.05	3.70	33.48	38.24
18	851 07 T 18.. $\frac{P}{S}$. 50..	851 07 RT 18.. $\frac{P}{S}$. 50..	44.40	43.80	28.60	17.90	2.64	31.75	44.44	21.30	19.95	3.70	36.68	41.24
20	851 07 T 20.. $\frac{P}{S}$. 50..	851 07 RT 20.. $\frac{P}{S}$. 50..	50.90	49.80	31.77	22.45	3.44	35.85	49.14	24.40	23.05	3.70	39.83	46.04
22	851 07 T 22.. $\frac{P}{S}$. 50..	851 07 RT 22.. $\frac{P}{S}$. 50..	50.90	49.80	34.95	22.45	3.44	38.20	52.24	27.50	25.55	3.70	43.03	49.24
24	851 07 T 24.. $\frac{P}{S}$. 50..	851 07 RT 24.. $\frac{P}{S}$. 50..	49.90	48.50	38.12	23.30	3.44	41.30	55.54	30.60	28.65	3.70	46.18	52.74

Note : toutes les dimensions sont en mm / all dimensions are in mm

851 Series



Embase à fixation par écrou avec raccord droit démontable pour reprise de tresse et gaine thermorétractable (spécifications 38 & 42) / *Jam nut receptacle with removable straight backshell for screen termination and heatshrink sleeving (38 & 42 suffix)*

07 T	
07 RT	



Taille de boîtier Shell size	Références / Part numbers		L max		A	B max	C max	D max	F max	G max	M max	P max	S max
	contacts à souder solder contacts	contacts à sertir crimp contacts	souder solder	sertir crimp									
8	851 07 T 8.. ^P _S . 50 ³⁸ ₄₂	851 07 RT 8.. ^P _S . 50 ³⁸ ₄₂	60.00		12.03	17.90	2.64	18.25	26.94	7.45	3.70	19.29	23.94
10	851 07 T 10.. ^P _S . 50 ³⁸ ₄₂	851 07 RT 10.. ^P _S . 50 ³⁸ ₄₂	60.00		15.01	17.90	2.64	20.25	30.14	9.00	3.70	22.38	26.94
12	851 07 T 12.. ^P _S . 50 ³⁸ ₄₂	851 07 RT 12.. ^P _S . 50 ³⁸ ₄₂	60.00		19.07	17.90	2.64	24.75	34.94	13.30	3.70	27.13	31.74
14	851 07 T 14.. ^P _S . 50 ³⁸ ₄₂	851 07 RT 14.. ^P _S . 50 ³⁸ ₄₂	60.00		22.25	17.90	2.64	27.75	38.04	16.50	3.70	30.33	34.94
16	851 07 T 16.. ^P _S . 50 ³⁸ ₄₂	851 07 RT 16.. ^P _S . 50 ³⁸ ₄₂	60.00		25.42	17.90	2.64	30.05	41.24	18.50	3.70	33.48	38.24
18	851 07 T 18.. ^P _S . 50 ³⁸ ₄₂	851 07 RT 18.. ^P _S . 50 ³⁸ ₄₂	60.40		28.60	17.90	2.64	34.15	44.44	21.90	3.70	36.68	41.34
20	851 07 T 20.. ^P _S . 50 ³⁸ ₄₂	851 07 RT 20.. ^P _S . 50 ³⁸ ₄₂	63.40		31.77	22.45	3.44	37.25	49.14	25.10	3.70	39.83	46.04
22	851 07 T 22.. ^P _S . 50 ³⁸ ₄₂	851 07 RT 22.. ^P _S . 50 ³⁸ ₄₂	63.40		34.95	22.45	3.44	40.45	52.24	28.20	3.70	43.03	49.24
24	851 07 T 24.. ^P _S . 50 ³⁸ ₄₂	851 07 RT 24.. ^P _S . 50 ³⁸ ₄₂	63.40		38.12	23.30	3.44	43.65	55.54	31.40	3.70	46.18	52.74

Embase à fixation par écrou avec raccord droit démontable pour reprise de tresse et gaine thermorétractable / *Jam nut receptacle with removable straight backshell for screen termination and heatshrink sleeving*

07 G	
07 RG	VG 95328 T



Taille de boîtier Shell size	Références / Part numbers		L max		A	B max	C max	D max	F max	G max	M max	P max	S max
	contacts à souder solder contacts	contacts à sertir crimp contacts	souder solder	sertir crimp									
8	851 07 G 8.. ^P _S . 50	851 07 RG 8.. ^P _S . 50	62.20		12.03	17.90	2.64	16.30	26.94	7.45	3.60	19.29	23.94
10	851 07 G 10.. ^P _S . 50	851 07 RG 10.. ^P _S . 50	62.20		15.01	17.90	2.64	18.30	30.14	10.30	3.60	22.38	26.94
12	851 07 G 12.. ^P _S . 50	851 07 RG 12.. ^P _S . 50	62.20		19.07	17.90	2.64	22.30	34.94	13.20	3.60	27.13	31.74
14	851 07 G 14.. ^P _S . 50	851 07 RG 14.. ^P _S . 50	62.40		22.25	17.90	2.64	25.30	38.04	16.50	3.60	30.33	34.94
16	851 07 G 16.. ^P _S . 50	851 07 RG 16.. ^P _S . 50	62.40		25.42	17.90	2.64	28.30	41.24	19.35	3.60	33.48	38.24
18	851 07 G 18.. ^P _S . 50	851 07 RG 18.. ^P _S . 50	62.40		28.60	17.90	2.64	32.30	44.44	21.60	3.60	36.68	41.34
20	851 07 G 20.. ^P _S . 50	851 07 RG 20.. ^P _S . 50	67.50		31.77	22.45	3.44	34.30	49.14	24.80	3.60	39.83	46.04
22	851 07 G 22.. ^P _S . 50	851 07 RG 22.. ^P _S . 50	67.50		34.95	22.45	3.44	38.30	52.24	27.90	3.60	43.03	49.24
24	851 07 G 24.. ^P _S . 50	851 07 RG 24.. ^P _S . 50	67.50		38.12	23.30	3.44	41.30	55.54	31.00	3.60	46.18	52.74

Note : toutes les dimensions sont en mm / all dimensions are in mm

851 Series



Embase à collerette carrée sans possibilité de raccord Square flange receptacle not accepting backshell

02 E	HE 301 B 02 E
	MS 3112 E
	VG 95328 H
02 R	HE 301 B 02 R
	MS 3122 E
	VG 95328 C



Taille de boîtier Shell size	Références / Part numbers		L max		A	B max	C max	D max	E	F max	J
	contacts à souder solder contacts	contacts à sertir crimp contacts	souder solder	sertir crimp							
8	851 02 E 8.. $\frac{P}{S}$. 50..	851 02 R 8.. $\frac{P}{S}$. 50..	25.18	32.35	12.03	11.70	1.32	10.84	15.09	20.99	3.13
10	851 02 E 10.. $\frac{P}{S}$. 50..	851 02 R 10.. $\frac{P}{S}$. 50..	25.10	32.35	15.01	11.70	1.32	13.99	18.26	24.19	3.13
12	851 02 E 12.. $\frac{P}{S}$. 50..	851 02 R 12.. $\frac{P}{S}$. 50..	25.10	32.35	19.07	11.70	1.32	17.37	20.62	26.54	3.13
14	851 02 E 14.. $\frac{P}{S}$. 50..	851 02 R 14.. $\frac{P}{S}$. 50..	25.10	32.35	22.25	11.70	1.32	20.57	23.00	28.89	3.13
16	851 02 E 16.. $\frac{P}{S}$. 50..	851 02 R 16.. $\frac{P}{S}$. 50..	25.10	32.35	25.42	11.70	1.32	23.72	24.61	31.29	3.13
18	851 02 E 18.. $\frac{P}{S}$. 50..	851 02 R 18.. $\frac{P}{S}$. 50..	25.10	32.35	28.60	11.70	1.32	26.69	26.97	33.69	3.13
20	851 02 E 20.. $\frac{P}{S}$. 50..	851 02 R 20.. $\frac{P}{S}$. 50..	26.67	33.95	31.77	14.35	2.15	29.89	29.36	36.89	3.13
22	851 02 E 22.. $\frac{P}{S}$. 50..	851 02 R 22.. $\frac{P}{S}$. 50..	26.67	33.95	34.95	14.35	2.15	33.04	31.75	39.99	3.13
24	851 02 E 24.. $\frac{P}{S}$. 50..	851 02 R 24.. $\frac{P}{S}$. 50..	26.67	33.95	38.12	15.20	2.15	36.24	34.92	43.15	3.81

Embase à fixation par écrou sans possibilité de raccord Jam nut receptacle not accepting backshell

07 A	HE 301 B 07 A
------	---------------



Taille de boîtier Shell size	Références / Part numbers		L max		A	B max	C max	F max	P max	S max
	contacts à souder solder contacts	contacts à sertir crimp contacts	souder solder	sertir crimp						
8	851 07 A 8.. $\frac{P}{S}$. 50..	-	25.18	-	12.03	17.90	2.64	26.94	19.29	23.94
10	851 07 A 10.. $\frac{P}{S}$. 50..	-	25.10	-	15.01	17.90	2.64	30.14	22.38	26.94
12	851 07 A 12.. $\frac{P}{S}$. 50..	-	25.10	-	19.07	17.90	2.64	34.94	27.13	31.74
14	851 07 A 14.. $\frac{P}{S}$. 50..	-	25.10	-	22.25	17.90	2.64	38.04	30.33	34.94
16	851 07 A 16.. $\frac{P}{S}$. 50..	-	25.10	-	25.42	17.90	2.64	41.24	33.48	38.24
18	851 07 A 18.. $\frac{P}{S}$. 50..	-	25.10	-	28.60	17.90	2.64	44.44	36.68	41.34
20	851 07 A 20.. $\frac{P}{S}$. 50..	-	26.67	-	31.77	22.45	3.44	49.14	39.83	46.04
22	851 07 A 22.. $\frac{P}{S}$. 50..	-	26.67	-	34.95	22.45	3.44	52.24	43.03	49.24
24	851 07 A 24.. $\frac{P}{S}$. 50..	-	26.67	-	38.12	23.30	3.44	55.54	46.18	52.74

Note : toutes les dimensions sont en mm / all dimensions are in mm

851 Series



Prolongateur avec raccord simple Cable connecting receptacle with backnut

01 E	HE 301 B 01 E
	MS 3111 E
01 R	HE 301 B 01 R
	MS 3121 E



Taille de boîtier Shell size	Références / Part numbers		L max		A	B max	C max	D max	F max	P max
	contacts à souder solder contacts	contacts à sertir crimp contacts	souder solder	sertir crimp						
8	851 01 E 8.. ^P / _S . 50..	851 01 R 8.. ^P / _S . 50..	32.70	32.00	12.03	10.60	2.10	13.50	24.24	20.99
10	851 01 E 10.. ^P / _S . 50..	851 01 R 10.. ^P / _S . 50..	32.70	32.00	15.01	10.60	2.10	16.70	27.44	24.19
12	851 01 E 12.. ^P / _S . 50..	851 01 R 12.. ^P / _S . 50..	32.70	32.00	19.07	10.60	2.10	19.90	29.79	26.54
14	851 01 E 14.. ^P / _S . 50..	851 01 R 14.. ^P / _S . 50..	32.70	32.00	22.25	10.60	2.10	23.40	32.10	28.89
16	851 01 E 16.. ^P / _S . 50..	851 01 R 16.. ^P / _S . 50..	32.70	32.00	25.42	10.60	2.10	26.60	34.59	31.29
18	851 01 E 18.. ^P / _S . 50..	851 01 R 18.. ^P / _S . 50..	32.70	32.00	28.60	10.60	2.10	29.50	36.94	33.69
20	851 01 E 20.. ^P / _S . 50..	851 01 R 20.. ^P / _S . 50..	34.50	33.40	31.77	13.85	2.65	32.70	40.14	36.89
22	851 01 E 22.. ^P / _S . 50..	851 01 R 22.. ^P / _S . 50..	34.50	33.40	34.95	13.85	2.65	36.00	43.24	40.00
24	851 01 E 24.. ^P / _S . 50..	851 01 R 24.. ^P / _S . 50..	34.50	33.40	38.12	14.70	2.65	39.10	46.44	43.29

Prolongateur avec raccord droit à serre-câbles Cable connecting receptacle with straight cable clamp

01 EC	HE 301 B 01 EC
	MS 3111 F
01 AC	HE 301 B 01 AC
01 RC	HE 301 B 01 RC
	MS 3121 F



Taille de boîtier Shell size	Références / Part numbers		L max		A	B max	C max	D max	F max	G	P max
	contacts à souder solder contacts	contacts à sertir crimp contacts	souder solder	sertir crimp							
8	851 01 ^{EC} / _{AC} 8.. ^P / _S . 50..	851 01 RC 8.. ^P / _S . 50..	48.00	47.30	12.03	10.60	2.10	19.90	24.24	3.50	20.99
10	851 01 ^{EC} / _{AC} 10.. ^P / _S . 50..	851 01 RC 10.. ^P / _S . 50..	48.00	47.30	15.01	10.60	2.10	21.50	27.44	5.00	24.19
12	851 01 ^{EC} / _{AC} 12.. ^P / _S . 50..	851 01 RC 12.. ^P / _S . 50..	48.00	47.30	19.07	10.60	2.10	25.00	29.79	8.20	26.54
14	851 01 ^{EC} / _{AC} 14.. ^P / _S . 50..	851 01 RC 14.. ^P / _S . 50..	48.00	47.30	22.25	10.60	2.10	27.80	32.10	10.00	28.89
16	851 01 ^{EC} / _{AC} 16.. ^P / _S . 50..	851 01 RC 16.. ^P / _S . 50..	51.00	50.50	25.42	10.60	2.10	29.40	34.59	13.00	31.29
18	851 01 ^{EC} / _{AC} 18.. ^P / _S . 50..	851 01 RC 18.. ^P / _S . 50..	51.00	50.50	28.60	10.60	2.10	35.30	36.94	16.00	33.69
20	851 01 ^{EC} / _{AC} 20.. ^P / _S . 50..	851 01 RC 20.. ^P / _S . 50..	53.00	51.50	31.77	13.85	2.65	35.30	40.14	16.00	36.89
22	851 01 ^{EC} / _{AC} 22.. ^P / _S . 50..	851 01 RC 22.. ^P / _S . 50..	53.00	51.50	34.95	13.85	2.65	41.10	43.24	19.30	40.00
24	851 01 ^{EC} / _{AC} 24.. ^P / _S . 50..	851 01 RC 24.. ^P / _S . 50..	53.00	51.50	38.12	14.70	2.65	42.40	46.44	20.60	43.29

Note : toutes les dimensions sont en mm / all dimensions are in mm

851 Series



Prolongateur avec raccord droit pour potting Cable connecting receptacle with straight backshell for potting

01 P	HE 301 B 01 P MS 3111 P
01 RP	HE 301 B 01 RP MS 3121 P

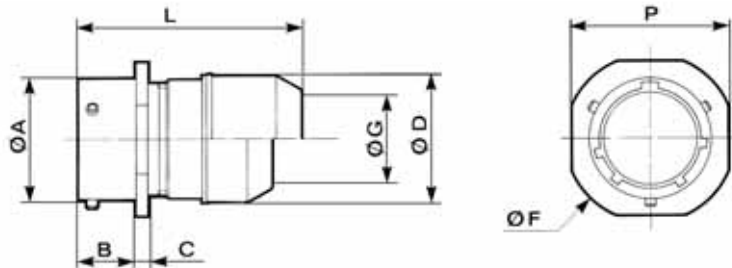

Taille de boîtier Shell size	Références / Part numbers		L max		A	B max	C max	D max	F max	G max	P max
	contacts à souder solder contacts	contacts à sertir crimp contacts	souder solder	sertir crimp							
8	851 01 P 8.. ^P / _S . 50..	851 01 RP 8.. ^P / _S . 50..	36.20	41.70	12.03	10.60	2.10	15.34	24.24	10.46	20.99
10	851 01 P 10.. ^P / _S . 50..	851 01 RP 10.. ^P / _S . 50..	36.20	41.70	15.01	10.60	2.10	17.70	27.44	13.55	24.19
12	851 01 P 12.. ^P / _S . 50..	851 01 RP 12.. ^P / _S . 50..	36.20	41.70	19.07	10.60	2.10	21.69	29.79	13.96	26.54
14	851 01 P 14.. ^P / _S . 50..	851 01 RP 14.. ^P / _S . 50..	36.20	41.70	22.25	10.60	2.10	23.90	32.10	17.42	28.89
16	851 01 P 16.. ^P / _S . 50..	851 01 RP 16.. ^P / _S . 50..	36.20	41.70	25.42	10.60	2.10	27.00	34.59	20.56	31.29
18	851 01 P 18.. ^P / _S . 50..	851 01 RP 18.. ^P / _S . 50..	36.91	44.46	28.60	10.60	2.10	30.50	36.94	23.66	33.69
20	851 01 P 20.. ^P / _S . 50..	851 01 RP 20.. ^P / _S . 50..	43.80	50.93	31.77	13.85	2.65	33.65	40.15	23.92	36.89
22	851 01 P 22.. ^P / _S . 50..	851 01 RP 22.. ^P / _S . 50..	43.80	50.93	34.95	13.85	2.65	37.10	42.24	25.52	40.00
24	851 01 P 24.. ^P / _S . 50..	851 01 RP 24.. ^P / _S . 50..	43.80	50.93	38.12	14.70	2.65	40.00	46.44	32.00	43.29

Prolongateur avec raccord droit intermédiaire Cable connecting receptacle with straight adaptor

01 A	HE 301 B 01 A
01 RA	HE 301 B 01 RA



Taille de boîtier Shell size	Références / Part numbers		L max		A	B max	C max	D max	F max	G max	K filetage threading UNEF 2A	P max
	contacts à souder solder contacts	contacts à sertir crimp contacts	souder solder	sertir crimp								
8	851 01 A 8.. ^P / _S . 50..	851 01 RA 8.. ^P / _S . 50..	41.00		12.03	10.60	2.10	14.50	24.24	9.10	1/2 28	20.99
10	851 01 A 10.. ^P / _S . 50..	851 01 RA 10.. ^P / _S . 50..	41.00		15.01	10.60	2.10	18.70	27.44	12.08	5/8 24	24.19
12	851 01 A 12.. ^P / _S . 50..	851 01 RA 12.. ^P / _S . 50..	41.00		19.07	10.60	2.10	21.70	29.79	15.25	3/4 20	26.54
14	851 01 A 14.. ^P / _S . 50..	851 01 RA 14.. ^P / _S . 50..	41.00		22.25	10.60	2.10	25.10	32.10	18.15	7/8 20	28.89
16	851 01 A 16.. ^P / _S . 50..	851 01 RA 16.. ^P / _S . 50..	41.00		25.42	10.60	2.10	28.13	34.59	21.32	1-20	31.29
18	851 01 A 18.. ^P / _S . 50..	851 01 RA 18.. ^P / _S . 50..	41.00		28.60	10.60	2.10	31.38	36.94	24.32	1-3/16 18	33.69
20	851 01 A 20.. ^P / _S . 50..	851 01 RA 20.. ^P / _S . 50..	44.00		31.77	13.85	2.65	34.30	40.15	26.73	1-3/16 18	36.89
22	851 01 A 22.. ^P / _S . 50..	851 01 RA 22.. ^P / _S . 50..	44.00		34.95	13.85	2.65	37.60	42.24	30.67	1-7/16 18	40.00
24	851 01 A 24.. ^P / _S . 50..	851 01 RA 24.. ^P / _S . 50..	44.00		38.12	14.70	2.65	40.70	46.44	33.08	1-7/16 18	43.29

Note : toutes les dimensions sont en mm / all dimensions are in mm

851 Series



Prolongateur avec raccord droit pour gaine thermorétractable Cable connecting receptacle with straight backshell for heatshrink sleeving

01 T	
01 RT	



Taille de boîtier Shell size	Références / Part numbers		L max		A	B max	C max	D max	F max	G max		P max	M max
	contacts à souder solder contacts	contacts à sertir crimp contacts	souder solder	sertir crimp						souder solder	sertir crimp		
8	851 01 T 8.. ^P / _S .50..	851 01 RT 8.. ^P / _S .50..	36.70	36.00	12.03	10.60	2.10	15.35	24.24	7.20	6.70	20.99	3.70
10	851 01 T 10.. ^P / _S .50..	851 01 RT 10.. ^P / _S .50..	36.70	36.00	15.01	10.60	2.10	18.15	27.44	10.20	9.40	24.19	3.70
12	851 01 T 12.. ^P / _S .50..	851 01 RT 12.. ^P / _S .50..	36.70	36.00	19.07	10.60	2.10	23.45	29.70	13.20	11.95	26.54	3.70
14	851 01 T 14.. ^P / _S .50..	851 01 RT 14.. ^P / _S .50..	36.70	36.00	22.25	10.60	2.10	24.25	32.10	16.10	15.15	28.89	3.70
16	851 01 T 16.. ^P / _S .50..	851 01 RT 16.. ^P / _S .50..	39.00	38.30	25.42	10.60	2.10	29.55	34.59	19.25	18.05	31.29	3.70
18	851 01 T 18.. ^P / _S .50..	851 01 RT 18.. ^P / _S .50..	39.00	38.30	28.60	10.60	2.10	31.75	36.94	21.30	19.95	33.69	3.70
20	851 01 T 20.. ^P / _S .50..	851 01 RT 20.. ^P / _S .50..	45.30	44.20	31.77	13.85	2.65	35.85	40.15	24.40	23.05	36.89	3.70
22	851 01 T 22.. ^P / _S .50..	851 01 RT 22.. ^P / _S .50..	45.30	44.20	34.95	13.85	2.65	38.20	42.24	27.50	25.55	40.00	3.70
24	851 01 T 24.. ^P / _S .50..	851 01 RT 24.. ^P / _S .50..	44.00	42.60	38.12	14.70	2.65	41.30	46.44	30.60	28.65	43.29	3.70

Prolongateur avec raccord droit démontable pour gaine thermorétractable Cable connecting receptacle with removable straight backshell for heatshrink sleeving

01 M	
01 RM	



Taille de boîtier Shell size	Références / Part numbers		L max		A	B max	C max	D max	F max	G max	P max	M max
	contacts à souder solder contacts	contacts à sertir crimp contacts	souder solder	sertir crimp								
8	851 01 M 8.. ^P / _S .50..	851 01 RM 8.. ^P / _S .50..	50.00		12.03	10.60	2.10	13.55	24.24	7.05	20.99	3.50
10	851 01 M 10.. ^P / _S .50..	851 01 RM 10.. ^P / _S .50..	50.00		15.01	10.60	2.10	15.35	27.44	9.90	24.19	3.50
12	851 01 M 12.. ^P / _S .50..	851 01 RM 12.. ^P / _S .50..	50.00		19.07	10.60	2.10	19.48	29.79	12.60	26.54	3.50
14	851 01 M 14.. ^P / _S .50..	851 01 RM 14.. ^P / _S .50..	50.00		22.25	10.60	2.10	21.30	32.10	15.90	28.89	3.50
16	851 01 M 16.. ^P / _S .50..	851 01 RM 16.. ^P / _S .50..	50.00		25.42	10.60	2.10	24.50	34.59	18.95	31.29	3.50
18	851 01 M 18.. ^P / _S .50..	851 01 RM 18.. ^P / _S .50..	50.00		28.60	10.60	2.10	26.45	36.94	20.90	33.69	3.50
20	851 01 M 20.. ^P / _S .50..	851 01 RM 20.. ^P / _S .50..	53.30		31.77	13.85	2.65	30.75	40.15	23.70	36.89	3.50
22	851 01 M 22.. ^P / _S .50..	851 01 RM 22.. ^P / _S .50..	53.30		34.95	13.85	2.65	34.24	42.24	26.60	40.00	3.50
24	851 01 M 24.. ^P / _S .50..	851 01 RM 24.. ^P / _S .50..	53.30		38.12	14.70	2.65	36.47	46.44	29.30	43.29	3.50

Note : toutes les dimensions sont en mm / all dimensions are in mm

851 Series



Prolongateur avec raccord droit démontable pour reprise de tresse et gaine thermorétractable (spécifications 38 & 42) / Cable connecting receptacle with removable straight backshell for screen termination and heatshrink sleeving (38 & 42 suffix)

01 T	
01 RT	



Taille de boîtier Shell size	Références / Part numbers		L max		A	B max	C max	D max	F max	G max	M max	P max
	contacts à souder solder contacts	contacts à sertir crimp contacts	souder solder	sertir crimp								
8	851 01 T 8.. P _S .50 ³⁸ ₄₂	851 01 RT 8.. P _S .50 ³⁸ ₄₂	51.60		12.03	10.60	2.10	18.25	24.24	7.45	3.70	20.99
10	851 01 T 10.. P _S .50 ³⁸ ₄₂	851 01 RT 10.. P _S .50 ³⁸ ₄₂	51.60		15.01	10.60	2.10	20.25	27.44	9.00	3.70	24.19
12	851 01 T 12.. P _S .50 ³⁸ ₄₂	851 01 RT 12.. P _S .50 ³⁸ ₄₂	51.60		19.07	10.60	2.10	24.75	29.79	13.30	3.70	26.54
14	851 01 T 14.. P _S .50 ³⁸ ₄₂	851 01 RT 14.. P _S .50 ³⁸ ₄₂	51.60		22.25	10.60	2.10	27.75	32.10	16.50	3.70	28.89
16	851 01 T 16.. P _S .50 ³⁸ ₄₂	851 01 RT 16.. P _S .50 ³⁸ ₄₂	51.60		25.42	10.60	2.10	30.05	34.59	18.50	3.70	31.29
18	851 01 T 18.. P _S .50 ³⁸ ₄₂	851 01 RT 18.. P _S .50 ³⁸ ₄₂	52.00		28.60	10.60	2.10	34.15	36.94	21.90	3.70	33.69
20	851 01 T 20.. P _S .50 ³⁸ ₄₂	851 01 RT 20.. P _S .50 ³⁸ ₄₂	55.10		31.77	13.85	2.65	37.25	40.15	25.10	3.70	36.89
22	851 01 T 22.. P _S .50 ³⁸ ₄₂	851 01 RT 22.. P _S .50 ³⁸ ₄₂	55.10		34.95	13.85	2.65	40.45	42.24	28.20	3.70	40.00
24	851 01 T 24.. P _S .50 ³⁸ ₄₂	851 01 RT 24.. P _S .50 ³⁸ ₄₂	55.10		38.12	14.70	2.65	43.65	46.44	31.40	3.70	43.29

Prolongateur avec raccord droit démontable pour reprise de tresse et gaine thermorétractable / Cable connecting receptacle with removable straight backshell for screen termination and heatshrink sleeving

01 G	
01 RG	



Taille de boîtier Shell size	Références / Part numbers		L max		A	B max	C max	D max	F max	G max	M max	P max
	contacts à souder solder contacts	contacts à sertir crimp contacts	souder solder	sertir crimp								
8	851 01 G 8.. P _S .50..	851 01 RG 8.. P _S .50..	54.00		12.03	10.60	2.10	16.30	24.24	7.45	3.60	20.99
10	851 01 G 10.. P _S .50..	851 01 RG 10.. P _S .50..	54.00		15.01	10.60	2.10	18.30	27.44	10.30	3.60	24.19
12	851 01 G 12.. P _S .50..	851 01 RG 12.. P _S .50..	54.00		19.07	10.60	2.10	22.30	29.79	13.20	3.60	26.54
14	851 01 G 14.. P _S .50..	851 01 RG 14.. P _S .50..	54.00		22.25	10.60	2.10	25.30	32.10	16.50	3.60	28.89
16	851 01 G 16.. P _S .50..	851 01 RG 16.. P _S .50..	54.00		25.42	10.60	2.10	28.30	34.59	19.35	3.60	31.29
18	851 01 G 18.. P _S .50..	851 01 RG 18.. P _S .50..	54.00		28.60	10.60	2.10	32.30	36.94	21.60	3.60	33.69
20	851 01 G 20.. P _S .50..	851 01 RG 20.. P _S .50..	59.30		31.77	13.85	2.65	34.30	40.15	24.80	3.60	36.89
22	851 01 G 22.. P _S .50..	851 01 RG 22.. P _S .50..	59.30		34.95	13.85	2.65	38.30	42.24	27.90	3.60	40.00
24	851 01 G 24.. P _S .50..	851 01 RG 24.. P _S .50..	59.30		38.12	14.70	2.65	41.30	46.44	31.00	3.60	43.29

Note : toutes les dimensions sont en mm / all dimensions are in mm

851 Series

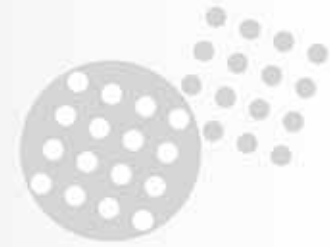

Prolongateur avec raccord droit à presse-étoupe Cable connecting receptacle with straight sealing gland backshell

01 J HE 301 B 01 J



Taille de boîtier Shell size	Références / Part numbers		L max		A	B max	C max	D max	F max	G		P max
	contacts à souder solder contacts	contacts à sertir crimp contacts	souder solder	sertir crimp						min	max	
8	851 01 J 8.. ^P / _§ .50..	-	47.60	-	12.03	10.60	2.10	14.40	24.24	5.02	5.84	20.99
10	851 01 J 10.. ^P / _§ .50..	-	47.60	-	15.01	10.60	2.10	17.60	27.44	5.94	6.76	24.19
12	851 01 J 12.. ^P / _§ .50..	-	48.70	-	19.07	10.60	2.10	21.10	29.79	9.34	10.16	26.54
14	851 01 J 14.. ^P / _§ .50..	-	53.50	-	22.25	10.60	2.10	24.40	32.10	11.32	12.14	28.89
16	851 01 J 16.. ^P / _§ .50..	-	59.00	-	25.42	10.60	2.10	27.60	34.59	14.73	15.55	31.29
18	851 01 J 18.. ^P / _§ .50..	-	65.00	-	28.60	10.60	2.10	30.80	36.94	16.00	16.82	33.69
20	851 01 J 20.. ^P / _§ .50..	-	79.10	-	31.77	13.85	2.65	34.10	40.15	16.89	17.71	36.89
22	851 01 J 22.. ^P / _§ .50..	-	80.00	-	34.95	13.85	2.65	37.30	42.24	17.78	18.60	40.00
24	851 01 J 24.. ^P / _§ .50..	-	90.00	-	38.12	14.70	2.65	40.50	46.44	20.34	21.16	43.29

Prolongateur avec raccord droit à presse-étoupe et serre-câbles Cable connecting receptacle with straight sealing gland and cable clamp backshell

01 JC MS 311 J



Taille de boîtier Shell size	Références / Part numbers		L max		A	B max	C max	D max	F max	G		P max
	contacts à souder solder contacts	contacts à sertir crimp contacts	souder solder	sertir crimp						min	max	
8	851 01 JC 8.. ^P / _§ .50..	-	57.68	-	12.03	10.60	2.10	19.90	24.24	5.02	5.84	20.99
10	851 01 JC 10.. ^P / _§ .50..	-	57.68	-	15.01	10.60	2.10	21.50	27.44	5.94	6.76	24.19
12	851 01 JC 12.. ^P / _§ .50..	-	61.24	-	19.07	10.60	2.10	25.00	29.79	9.34	10.16	26.54
14	851 01 JC 14.. ^P / _§ .50..	-	66.01	-	22.25	10.60	2.10	27.80	32.10	11.32	12.14	28.89
16	851 01 JC 16.. ^P / _§ .50..	-	74.75	-	25.42	10.60	2.10	29.40	34.59	14.73	15.50	31.29
18	851 01 JC 18.. ^P / _§ .50..	-	80.57	-	28.60	10.60	2.10	35.30	36.94	16.00	16.82	33.69
20	851 01 JC 20.. ^P / _§ .50..	-	91.69	-	31.77	13.85	2.65	35.30	40.15	16.89	17.71	36.89
22	851 01 JC 22.. ^P / _§ .50..	-	95.66	-	34.95	13.85	2.65	41.10	42.24	17.78	18.60	40.00
24	851 01 JC 24.. ^P / _§ .50..	-	101.22	-	38.12	14.70	2.65	42.40	46.44	20.34	21.16	43.29

Note : toutes les dimensions sont en mm / all dimensions are in mm

851 Series



Fiche avec raccord simple Plug with backnut

06 E	HE 301 B 06 E
	MS 3116 E
06 R	HE 301 B 06 R
	MS 3126 E

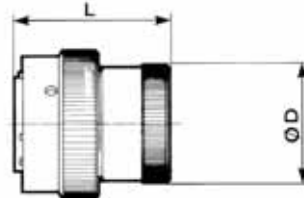

Taille de boîtier Shell size	Références / Part numbers		L max		A max	D max
	contacts à souder solder contacts	contacts à sertir crimp contacts	souder solder	sertir crimp		
8	851 06 E 8 .. _S ^P . 50..	851 06 R 8 .. _S ^P . 50 ..	32.54	32.00	19.05	13.50
10	851 06 E 10 .. _S ^P . 50..	851 06 R 10 .. _S ^P . 50..	32.54	32.00	21.80	16.70
12	851 06 E 12 .. _S ^P . 50..	851 06 R 12 .. _S ^P . 50..	32.54	32.00	26.15	19.90
14	851 06 E 14 .. _S ^P . 50..	851 06 R 14 .. _S ^P . 50..	32.54	32.00	29.35	23.40
16	851 06 E 16 .. _S ^P . 50..	851 06 R 16 .. _S ^P . 50..	32.54	32.00	32.50	26.60
18	851 06 E 18 .. _S ^P . 50..	851 06 R 18 .. _S ^P . 50..	32.54	32.00	35.30	29.60
20	851 06 E 20 .. _S ^P . 50..	851 06 R 20 .. _S ^P . 50..	33.30	32.10	38.85	32.70
22	851 06 E 22 .. _S ^P . 50..	851 06 R 22 .. _S ^P . 50..	33.30	32.10	42.05	36.00
24	851 06 E 24 .. _S ^P . 50..	851 06 R 24 .. _S ^P . 50..	33.30	32.10	45.10	39.10

Fiche avec raccord droit à serre-câbles Plug with straight cable clamp

06 EC	HE 301 B 06 EC
	MS 3116 F
06 AC	HE 301 B 06 AC
06 RC	HE 301 B 06 RC
	MS 3126 F VG 95328 K

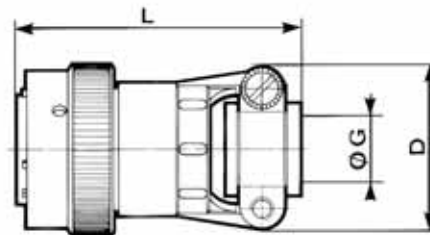

Taille de boîtier Shell size	Références / Part numbers		L max		A max	D max	G
	contacts à souder solder contacts	contacts à sertir crimp contacts	souder solder	sertir crimp			
8	851 06 ^{EC} _{AC} 8 .. _S ^P . 50..	851 06 RC 8 .. _S ^P . 50 ..	48.00	47.30	19.05	19.90	3.50
10	851 06 ^{EC} _{AC} 10 .. _S ^P . 50..	851 06 RC 10 .. _S ^P . 50..	48.00	47.30	21.80	21.50	5.00
12	851 06 ^{EC} _{AC} 12 .. _S ^P . 50..	851 06 RC 12 .. _S ^P . 50..	48.00	47.30	26.15	25.00	8.20
14	851 06 ^{EC} _{AC} 14 .. _S ^P . 50..	851 06 RC 14 .. _S ^P . 50..	48.00	47.30	29.35	27.80	10.00
16	851 06 ^{EC} _{AC} 16 .. _S ^P . 50..	851 06 RC 16 .. _S ^P . 50..	51.00	50.50	32.50	29.40	13.00
18	851 06 ^{EC} _{AC} 18 .. _S ^P . 50..	851 06 RC 18 .. _S ^P . 50..	51.00	50.50	35.30	35.30	16.00
20	851 06 ^{EC} _{AC} 20 .. _S ^P . 50..	851 06 RC 20 .. _S ^P . 50..	52.00	50.20	38.85	35.30	16.00
22	851 06 ^{EC} _{AC} 22 .. _S ^P . 50..	851 06 RC 22 .. _S ^P . 50..	52.00	50.20	42.05	41.10	19.30
24	851 06 ^{EC} _{AC} 24 .. _S ^P . 50..	851 06 RC 24 .. _S ^P . 50..	52.00	50.20	45.10	42.40	20.60

Note : toutes les dimensions sont en mm / all dimensions are in mm

851 Series



Fiche avec raccord droit pour potting Plug with straight backshell for potting

06 P	HE 301 B 06 P
	MS 3116 P
06 RP	HE 301 B 06 RP
	MS 3126 P



Taille de boîtier Shell size	Références / Part numbers		L max		A max	D max	G
	contacts à souder solder contacts	contacts à sertir crimp contacts	souder solder	sertir crimp			
8	851 06 P 8 .. _S . 50..	851 06 RP 8 .. _S . 50..	36.20	42.10	19.05	15.34	10.46
10	851 06 P 10 .. _S . 50..	851 06 RP 10 .. _S . 50..	36.20	42.10	21.80	17.70	13.55
12	851 06 P 12 .. _S . 50..	851 06 RP 12 .. _S . 50..	36.20	42.10	26.15	21.69	13.96
14	851 06 P 14 .. _S . 50..	851 06 RP 14 .. _S . 50..	36.20	42.10	29.35	23.90	17.42
16	851 06 P 16 .. _S . 50..	851 06 RP 16 .. _S . 50..	36.20	42.10	32.50	27.00	20.56
18	851 06 P 18 .. _S . 50..	851 06 RP 18 .. _S . 50..	37.70	45.40	35.30	30.50	23.66
20	851 06 P 20 .. _S . 50..	851 06 RP 20 .. _S . 50..	42.40	50.00	38.85	33.65	23.92
22	851 06 P 22 .. _S . 50..	851 06 RP 22 .. _S . 50..	42.40	50.00	42.05	37.10	25.52
24	851 06 P 24 .. _S . 50..	851 06 RP 24 .. _S . 50..	42.85	50.00	45.10	40.00	32.00

Fiche avec raccord droit intermédiaire Plug with straight adaptor

06 A	HE 301 B 06 A
06 RA	HE 301 B 06 RA



Taille de boîtier Shell size	Références / Part numbers		L max		A max	D max	G max	F filetage threading UNEF 2A
	contacts à souder solder contacts	contacts à sertir crimp contacts	souder solder	sertir crimp				
8	851 06 A 8 .. _S . 50..	851 06 RA 8 .. _S . 50..	41.00	41.00	19.05	14.50	9.10	1/2 28
10	851 06 A 10 .. _S . 50..	851 06 RA 10 .. _S . 50..	41.00	41.00	21.80	18.70	12.08	5/8 24
12	851 06 A 12 .. _S . 50..	851 06 RA 12 .. _S . 50..	41.00	41.00	26.15	21.70	15.25	3/4 20
14	851 06 A 14 .. _S . 50..	851 06 RA 14 .. _S . 50..	41.00	41.00	29.35	25.10	18.15	7/8 20
16	851 06 A 16 .. _S . 50..	851 06 RA 16 .. _S . 50..	41.00	41.00	32.50	28.13	21.32	1-20
18	851 06 A 18 .. _S . 50..	851 06 RA 18 .. _S . 50..	41.00	41.00	35.30	31.38	24.32	1-3/16 18
20	851 06 A 20 .. _S . 50..	851 06 RA 20 .. _S . 50..	44.00	43.30	38.85	34.30	26.73	1-3/16 18
22	851 06 A 22 .. _S . 50..	851 06 RA 22 .. _S . 50..	44.00	43.30	42.05	37.60	30.67	1-7/16 18
24	851 06 A 24 .. _S . 50..	851 06 RA 24 .. _S . 50..	44.00	43.50	45.10	40.70	33.08	1-7/16 18

Note : toutes les dimensions sont en mm / all dimensions are in mm

851 Series



Fiche avec raccord droit pour gaine thermorétractable Plug with straight backshell for heatshrink sleeving

06 T	
06 RT	VG 95328 J



Taille de boîtier Shell size	Références / Part numbers		L max		A max	D max	G max		M max
	contacts à souder solder contacts	contacts à sertir crimp contacts	souder solder	sertir crimp			souder solder	sertir crimp	
8	851 06 T 8.. $\frac{P}{S}$. 50..	851 06 RT 8.. $\frac{P}{S}$. 50..	36.70	36.00	19.05	15.35	7.20	6.70	3.70
10	851 06 T 10.. $\frac{P}{S}$. 50..	851 06 RT 10.. $\frac{P}{S}$. 50..	36.70	36.00	21.80	18.15	10.20	9.40	3.70
12	851 06 T 12.. $\frac{P}{S}$. 50..	851 06 RT 12.. $\frac{P}{S}$. 50..	36.70	36.00	26.15	23.45	13.20	11.95	3.70
14	851 06 T 14.. $\frac{P}{S}$. 50..	851 06 RT 14.. $\frac{P}{S}$. 50..	36.70	36.00	29.35	24.25	16.10	15.15	3.70
16	851 06 T 16.. $\frac{P}{S}$. 50..	851 06 RT 16.. $\frac{P}{S}$. 50..	39.00	38.30	32.50	29.55	19.25	18.05	3.70
18	851 06 T 18.. $\frac{P}{S}$. 50..	851 06 RT 18.. $\frac{P}{S}$. 50..	39.00	38.30	35.30	31.75	21.30	19.95	3.70
20	851 06 T 20.. $\frac{P}{S}$. 50..	851 06 RT 20.. $\frac{P}{S}$. 50..	44.00	42.90	38.85	35.85	24.40	23.05	3.70
22	851 06 T 22.. $\frac{P}{S}$. 50..	851 06 RT 22.. $\frac{P}{S}$. 50..	44.00	42.90	42.05	38.20	27.50	25.55	3.70
24	851 06 T 24.. $\frac{P}{S}$. 50..	851 06 RT 24.. $\frac{P}{S}$. 50..	42.70	41.60	45.10	41.30	30.60	28.65	3.70

Fiche avec raccord droit démontable pour gaine thermorétractable Plug with removable straight backshell for heatshrink sleeving

06 M	
06 RM	

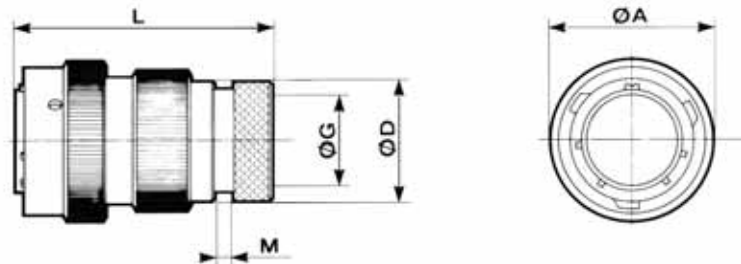

Taille de boîtier Shell size	Références / Part numbers		L max		A max	D max	G max	M max
	contacts à souder solder contacts	contacts à sertir crimp contacts	souder solder	sertir crimp				
8	851 06 M 8 .. $\frac{P}{S}$. 50..	851 06 RM 8 .. $\frac{P}{S}$. 50..	50.00		19.05	13.55	7.05	3.50
10	851 06 M 10 .. $\frac{P}{S}$. 50..	851 06 RM 10 .. $\frac{P}{S}$. 50..	50.00		21.80	15.35	9.90	3.50
12	851 06 M 12 .. $\frac{P}{S}$. 50..	851 06 RM 12 .. $\frac{P}{S}$. 50..	50.00		26.15	19.48	12.60	3.50
14	851 06 M 14 .. $\frac{P}{S}$. 50..	851 06 RM 14 .. $\frac{P}{S}$. 50..	50.00		29.35	21.30	15.90	3.50
16	851 06 M 16 .. $\frac{P}{S}$. 50..	851 06 RM 16 .. $\frac{P}{S}$. 50..	50.00		32.50	24.50	18.95	3.50
18	851 06 M 18 .. $\frac{P}{S}$. 50..	851 06 RM 18 .. $\frac{P}{S}$. 50..	50.00		35.30	26.45	20.90	3.50
20	851 06 M 20 .. $\frac{P}{S}$. 50..	851 06 RM 20 .. $\frac{P}{S}$. 50..	52.00		38.85	30.73	23.70	3.50
22	851 06 M 22 .. $\frac{P}{S}$. 50..	851 06 RM 22 .. $\frac{P}{S}$. 50..	52.00		42.05	34.24	26.60	3.50
24	851 06 M 24 .. $\frac{P}{S}$. 50..	851 06 RM 24 .. $\frac{P}{S}$. 50..	52.00		45.10	36.47	29.30	3.50

Note : toutes les dimensions sont en mm / all dimensions are in mm

851 Series



Fiche avec raccord droit à presse-étoupe Plug with straight sealing gland backshell

06 J HE 301 B 06 J

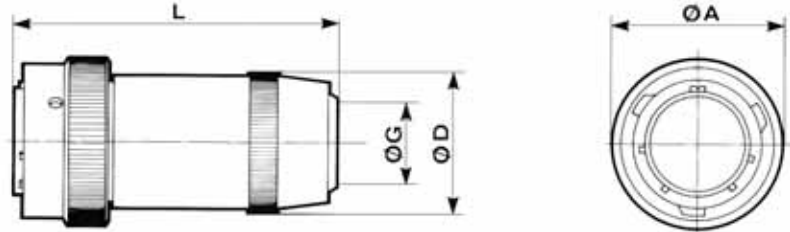

Taille de boîtier Shell size	Références / Part numbers		L max		A max	D max	G max	
	contacts à souder solder contacts	contacts à sertir crimp contacts	souder solder	sertir crimp			min	max
8	851 06 J 8 .. ^P / _S . 50..	-	47.60	-	19.05	14.40	5.02	5.84
10	851 06 J 10 .. ^P / _S . 50..	-	47.60	-	21.80	17.60	5.94	6.76
12	851 06 J 12 .. ^P / _S . 50..	-	49.20	-	26.15	21.10	9.34	10.16
14	851 06 J 14 .. ^P / _S . 50..	-	54.00	-	29.35	24.40	11.32	12.14
16	851 06 J 16 .. ^P / _S . 50..	-	59.60	-	32.50	27.60	14.73	15.55
18	851 06 J 18 .. ^P / _S . 50..	-	65.60	-	35.30	30.80	16.00	16.80
20	851 06 J 20 .. ^P / _S . 50..	-	78.00	-	38.85	34.10	16.89	17.71
22	851 06 J 22 .. ^P / _S . 50..	-	79.50	-	42.05	37.30	17.78	18.60
24	851 06 J 24 .. ^P / _S . 50..	-	90.00	-	45.10	40.50	20.34	21.16

Fiche avec raccord droit à presse-étoupe et serre-câbles Plug with straight sealing gland and cable clamp backshells

06 JC MS 3116 J



Taille de boîtier Shell size	Références / Part numbers		L max		A max	D max	G max	
	contacts à souder solder contacts	contacts à sertir crimp contacts	souder solder	sertir crimp			min	max
8	851 06 JC 8 .. ^P / _S . 50..	-	57.68	-	19.05	19.90	5.02	5.84
10	851 06 JC 10 .. ^P / _S . 50..	-	57.68	-	21.80	21.50	5.94	6.76
12	851 06 JC 12 .. ^P / _S . 50..	-	61.24	-	26.15	25.00	9.34	10.16
14	851 06 JC 14 .. ^P / _S . 50..	-	66.01	-	29.35	27.80	11.32	12.14
16	851 06 JC 16 .. ^P / _S . 50..	-	74.75	-	32.50	29.40	14.73	15.50
18	851 06 JC 18 .. ^P / _S . 50..	-	80.57	-	35.30	35.30	16.00	16.82
20	851 06 JC 20 .. ^P / _S . 50..	-	91.69	-	38.85	35.30	16.89	17.71
22	851 06 JC 22 .. ^P / _S . 50..	-	95.66	-	42.05	41.10	17.78	18.60
24	851 06 JC 24 .. ^P / _S . 50..	-	101.22	-	45.10	42.40	20.34	21.16

Note : toutes les dimensions sont en mm / all dimensions are in mm

851 Series



Fiche avec raccord coudé à serre-câbles Plug with elbow cable clamp backshell

08 EC	HE 301 B 08 EC
08 RC	HE 301 B 08 RC



Taille de boîtier Shell size	Références / Part numbers		L max		A max	D max	G	R max
	contacts à souder solder contacts	contacts à sertir crimp contacts	souder solder	sertir crimp				
8	851 08 EC 8 .. $\frac{P}{S}$. 50..	851 08 RC 8 .. $\frac{P}{S}$. 50..	50.10		19.05	19.70	3.50	16.00
10	851 08 EC 10 .. $\frac{P}{S}$. 50..	851 08 RC 10 .. $\frac{P}{S}$. 50..	52.60		21.80	21.20	5.00	18.00
12	851 08 EC 12 .. $\frac{P}{S}$. 50..	851 08 RC 12 .. $\frac{P}{S}$. 50..	54.90		26.15	24.20	8.20	19.50
14	851 08 EC 14 .. $\frac{P}{S}$. 50..	851 08 RC 14 .. $\frac{P}{S}$. 50..	58.50		29.35	27.50	10.00	22.00
16	851 08 EC 16 .. $\frac{P}{S}$. 50..	851 08 RC 16 .. $\frac{P}{S}$. 50..	60.80		32.50	29.10	13.00	23.50
18	851 08 EC 18 .. $\frac{P}{S}$. 50..	851 08 RC 18 .. $\frac{P}{S}$. 50..	65.00		35.30	35.70	16.00	25.00
20	851 08 EC 20 .. $\frac{P}{S}$. 50..	851 08 RC 20 .. $\frac{P}{S}$. 50..	69.10		38.85	35.70	16.00	26.50
22	851 08 EC 22 .. $\frac{P}{S}$. 50..	851 08 RC 22 .. $\frac{P}{S}$. 50..	71.00		42.05	39.70	19.30	28.00
24	851 08 EC 24 .. $\frac{P}{S}$. 50..	851 08 RC 24 .. $\frac{P}{S}$. 50..	75.50		45.10	43.50	20.60	31.00

Fiche avec raccord coudé pour potting Plug with elbow backshell for potting

08 P	HE 301 B 08 P
08 RP	HE 301 B 08 RP



Taille de boîtier Shell size	Références / Part numbers		L max		A max	G max	R max	S max
	contacts à souder solder contacts	contacts à sertir crimp contacts	souder solder	sertir crimp				
8	851 08 P 8 .. $\frac{P}{S}$. 50..	851 08 RP 8 .. $\frac{P}{S}$. 50..	40.70		19.05	8.10	11.70	11.30
10	851 08 P 10 .. $\frac{P}{S}$. 50..	851 08 RP 10 .. $\frac{P}{S}$. 50..	44.90		21.80	11.30	14.35	14.50
12	851 08 P 12 .. $\frac{P}{S}$. 50..	851 08 RP 12 .. $\frac{P}{S}$. 50..	46.90		26.15	13.30	15.90	17.70
14	851 08 P 14 .. $\frac{P}{S}$. 50..	851 08 RP 14 .. $\frac{P}{S}$. 50..	49.20		29.35	16.10	16.30	20.10
16	851 08 P 16 .. $\frac{P}{S}$. 50..	851 08 RP 16 .. $\frac{P}{S}$. 50..	50.60		32.50	16.90	19.30	22.80
18	851 08 P 18 .. $\frac{P}{S}$. 50..	851 08 RP 18 .. $\frac{P}{S}$. 50..	51.80		35.30	18.10	20.60	25.60
20	851 08 P 20 .. $\frac{P}{S}$. 50..	851 08 RP 20 .. $\frac{P}{S}$. 50..	53.70		38.85	19.70	21.90	28.80
22	851 08 P 22 .. $\frac{P}{S}$. 50..	851 08 RP 22 .. $\frac{P}{S}$. 50..	54.80		42.05	20.80	23.50	31.60
24	851 08 P 24 .. $\frac{P}{S}$. 50..	851 08 RP 24 .. $\frac{P}{S}$. 50..	58.20		45.10	24.20	30.15	35.20

Note : toutes les dimensions sont en mm / all dimensions are in mm

851 Series



Fiche avec bracelet de blindage et raccord intermédiaire *Screened plug with straight adaptor*

36 A	
36 RA	VG 95328 N



Taille de boîtier Shell size	Références / Part numbers		L max		A max	D max	G max	F filetage threading UNEF 2A
	contacts à souder solder contacts	contacts à sertir crimp contacts	souder solder	sertir crimp				
8	851 36 A 8 .. P _S . 50..	851 36 RA 8 .. P _S . 50..	41.00		19.05	14.50	9.10	1/2 28
10	851 36 A 10 .. P _S . 50..	851 36 RA 10 .. P _S . 50..	41.00		21.80	18.70	12.08	5/8 24
12	851 36 A 12 .. P _S . 50..	851 36 RA 12 .. P _S . 50..	41.00		26.15	21.70	15.25	3/4 20
14	851 36 A 14 .. P _S . 50..	851 36 RA 14 .. P _S . 50..	41.00		29.35	25.10	18.15	7/8 20
16	851 36 A 16 .. P _S . 50..	851 36 RA 16 .. P _S . 50..	41.00		32.50	28.13	21.32	1-20
18	851 36 A 18 .. P _S . 50..	851 36 RA 18 .. P _S . 50..	41.00		35.30	31.38	24.32	1-3/16 18
20	851 36 A 20 .. P _S . 50..	851 36 RA 20 .. P _S . 50..	43.30		38.85	34.30	26.73	1-3/16 18
22	851 36 A 22 .. P _S . 50..	851 36 RA 22 .. P _S . 50..	43.30		42.05	37.60	30.67	1-7/16 18
24	851 36 A 24 .. P _S . 50..	851 36 RA 24 .. P _S . 50..	43.50		45.10	40.70	33.08	1-7/16 18

Fiche avec bague de blindage et raccord droit démontable pour reprise de tresse et gaine thermorétractable (spécifications 38 & 42)/ *Screened plug with removable straight backshell for screen termination and heatshrink sleeving (38 & 42 suffix)*

36 T	
36 RT	



Taille de boîtier Shell size	Références / Part numbers		L max		A max	D max	G max	M max
	contacts à souder solder contacts	contacts à sertir crimp contacts	souder solder	sertir crimp				
8	851 36 T 8 .. P _S . 50.. ³⁸ / ₄₂	851 36 RT 8 .. P _S . 50.. ³⁸ / ₄₂	51.60		19.05	18.25	7.45	3.70
10	851 36 T 10 .. P _S . 50.. ³⁸ / ₄₂	851 36 RT 10 .. P _S . 50.. ³⁸ / ₄₂	51.60		21.80	20.25	9.00	3.70
12	851 36 T 12 .. P _S . 50.. ³⁸ / ₄₂	851 36 RT 12 .. P _S . 50.. ³⁸ / ₄₂	51.60		26.15	24.75	13.30	3.70
14	851 36 T 14 .. P _S . 50.. ³⁸ / ₄₂	851 36 RT 14 .. P _S . 50.. ³⁸ / ₄₂	51.60		29.35	27.75	16.50	3.70
16	851 36 T 16 .. P _S . 50.. ³⁸ / ₄₂	851 36 RT 16 .. P _S . 50.. ³⁸ / ₄₂	51.60		32.50	30.05	18.50	3.70
18	851 36 T 18 .. P _S . 50.. ³⁸ / ₄₂	851 36 RT 18 .. P _S . 50.. ³⁸ / ₄₂	52.00		35.30	34.15	21.90	3.70
20	851 36 T 20 .. P _S . 50.. ³⁸ / ₄₂	851 36 RT 20 .. P _S . 50.. ³⁸ / ₄₂	53.90		38.85	37.25	25.10	3.70
22	851 36 T 22 .. P _S . 50.. ³⁸ / ₄₂	851 36 RT 22 .. P _S . 50.. ³⁸ / ₄₂	53.90		42.05	40.45	28.20	3.70
24	851 36 T 24 .. P _S . 50.. ³⁸ / ₄₂	851 36 RT 24 .. P _S . 50.. ³⁸ / ₄₂	53.90		45.10	43.65	31.40	3.70

Note : toutes les dimensions sont en mm / all dimensions are in mm

851 Series



Fiche avec bague de blindage et raccord droit démontable pour reprise de tresse et gaine thermorétractable / Screened plug with removable straight backshell for screen termination and heatshrink sleeving

36 G	
36 RG	VG 95328 M



Taille de boîtier Shell size	Références / Part numbers		L max		A max	D max	G max	M max
	contacts à souder solder contacts	contacts à sertir crimp contacts	souder solder	sertir crimp				
8	851 36 G 8 .. ^P / _S . 50..	851 36 RG 8 .. ^P / _S . 50..	54.00		19.05	16.30	7.45	3.60
10	851 36 G 10 .. ^P / _S . 50..	851 36 RG 10 .. ^P / _S . 50..	54.00		21.80	18.30	10.30	3.60
12	851 36 G 12 .. ^P / _S . 50..	851 36 RG 12 .. ^P / _S . 50..	54.00		26.15	22.30	13.20	3.60
14	851 36 G 14 .. ^P / _S . 50..	851 36 RG 14 .. ^P / _S . 50..	54.00		29.35	25.30	16.50	3.60
16	851 36 G 16 .. ^P / _S . 50..	851 36 RG 16 .. ^P / _S . 50..	54.00		32.50	28.30	19.35	3.60
18	851 36 G 18 .. ^P / _S . 50..	851 36 RG 18 .. ^P / _S . 50..	54.00		35.30	32.30	21.60	3.60
20	851 36 G 20 .. ^P / _S . 50..	851 36 RG 20 .. ^P / _S . 50..	58.00		38.85	34.30	24.80	3.60
22	851 36 G 22 .. ^P / _S . 50..	851 36 RG 22 .. ^P / _S . 50..	58.00		42.05	38.30	27.90	3.60
24	851 36 G 24 .. ^P / _S . 50..	851 36 RG 24 .. ^P / _S . 50..	58.00		45.10	41.30	31.00	3.60

Fiche avec raccord pour adaptation d'accessoires au pas électrique Plug with straight adaptor for electrical pitch access

06 Z	
06 RZ	

Le manchon intermédiaire spécial de type Z qui équipe la fiche à sertir 851 06 RZ est adapté aux accessoires de câblages.

- Raccord à griffes et presse-étoupe
- Raccord pour gaine polyflex
- Raccord pour tuyau C.N.O.M.O.

The Z type special adaptor which equips crimp plug 851 06 RZ fits following accessories.

- Packing gland collet backshell
- Backshell for polyflex sleeving
- Backshell for C.N.O.M.O. tube



Taille de boîtier Shell size	Références / Part numbers		L max		A max	B max	C max	D filetage threading PE
	contacts à souder solder contacts	contacts à sertir crimp contacts	souder solder	sertir crimp				
8								
10								
12	851 06 Z 12 .. ^P / _S . 50..	851 06 RZ 12 .. ^P / _S . 50..	43.00		26.15	9.10	24.80	11
14	851 06 Z 14 .. ^P / _S . 50..	851 06 RZ 14 .. ^P / _S . 50..	45.00		29.35	11.00	28.80	16
16	851 06 Z 16 .. ^P / _S . 50..	851 06 RZ 16 .. ^P / _S . 50..	45.00		32.50	11.00	30.80	16
18	851 06 Z 18 .. ^P / _S . 50..	851 06 RZ 18 .. ^P / _S . 50..	46.00		35.30	12.00	40.80	21
20	851 06 Z 20 .. ^P / _S . 50..	851 06 RZ 20 .. ^P / _S . 50..	46.50		38.85	12.00	40.80	21
22	851 06 Z 22 .. ^P / _S . 50..	851 06 RZ 22 .. ^P / _S . 50..	46.50		42.05	12.00	40.80	21
24	851 06 Z 24 .. ^P / _S . 50..	851 06 RZ 24 .. ^P / _S . 50..	65.50		45.10	31.40	45.00	29

Note : toutes les dimensions sont en mm / all dimensions are in mm



851 Series

Fiche avec bague de blindage et doigt de verrouillage, avec raccord droit court à reprise de tresse et gaine thermorétractable / *Screened plug with lock finger and short backshell for screen termination and heatshrink sleeving*

76 U	
76 RU	



Taille de boîtier Shell size	Références / Part numbers		L max		A max	D max	H max	G max	E max	M max
	contacts à souder solder contacts	contacts à sertir crimp contacts	souder solder	sertir crimp						
8										
10										
12	851 76 U 12.. ^P / _S .50..	851 76 R U 12.. ^P / _S .50..	35.60		25.00	22.50	32.00	13.20	19.50	3.70
14	851 76 U 14.. ^P / _S .50..	851 76 R U 14.. ^P / _S .50..	35.60		29.00	25.50	32.00	16.10	21.00	3.70
16	851 76 U 16.. ^P / _S .50..	851 76 R U 16.. ^P / _S .50..	35.60		32.00	28.50	32.00	19.25	22.50	3.70
18										
20										
22										
24										

Note : toutes les dimensions sont en mm / all dimensions are in mm



Connecteurs hermétiques / Hermetic connectors

Embase à collerette carrée Square flange receptacle

02 H HE 301 B 02 H

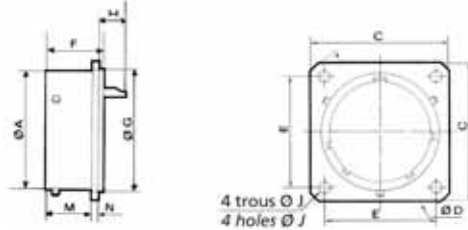

Taille de boîtier Shell size	Références / Part numbers	A	C max	D max	E	F	G	H max	J	M max	N max
8	851 02 H 8 .. ^P / _S .. 50..	12.03	21.42	27.09	15.09	13.84	14.27	6.97	3.13	11.24	1.67
10	851 02 H 10 .. ^P / _S .. 50..	15.01	24.62	31.87	18.26	13.84	17.06	6.97	3.13	11.24	1.67
12	851 02 H 12 .. ^P / _S .. 50..	19.07	26.98	35.04	20.62	13.84	19.85	6.97	3.13	11.24	1.67
14	851 02 H 14 .. ^P / _S .. 50..	22.25	29.36	38.22	23.00	13.84	23.00	6.97	3.13	11.24	1.67
16	851 02 H 16 .. ^P / _S .. 50..	25.42	31.73	41.39	24.61	13.84	26.18	6.97	3.13	11.24	1.67
18	851 02 H 18 .. ^P / _S .. 50..	28.60	34.12	44.57	26.97	13.84	29.36	6.97	3.13	11.24	1.67
20	851 02 H 20 .. ^P / _S .. 50..	31.77	37.20	47.74	29.36	15.42	31.74	6.99	3.13	12.00	2.48
22	851 02 H 22 .. ^P / _S .. 50..	34.95	40.47	50.92	31.75	16.23	34.92	6.99	3.13	12.00	2.48
24	851 02 H 24 .. ^P / _S .. 50..	38.12	43.66	55.69	34.92	17.04	38.10	6.19	3.81	12.81	2.48

Embase à fixation par écrou Jam nut receptacle

07 H
HE 301 B 07 H
MS 3114 H
VG 95328 F



Taille de boîtier Shell size	Références / Part numbers	A	C max	D max	G	L max	M max	P
8	851 07 H 8 .. ^P / _S .. 50..	12.03	24.07	27.37	14.26	20.53	17.93	13.33
10	851 07 H 10 .. ^P / _S .. 50..	15.01	27.22	30.57	17.43	20.53	17.93	16.51
12	851 07 H 12 .. ^P / _S .. 50..	19.07	32.00	35.32	22.19	20.53	17.93	20.63
14	851 07 H 14 .. ^P / _S .. 50..	22.25	35.17	38.50	25.36	20.53	17.93	23.78
16	851 07 H 16 .. ^P / _S .. 50..	25.42	38.35	41.67	28.54	20.53	17.93	26.93
18	851 07 H 18 .. ^P / _S .. 50..	28.60	41.52	44.85	31.71	20.53	17.93	30.10
20	851 07 H 20 .. ^P / _S .. 50..	31.77	46.27	49.62	34.89	26.10	22.70	33.28
22	851 07 H 22 .. ^P / _S .. 50..	34.95	49.47	52.77	38.06	26.10	22.70	36.45
24	851 07 H 24 .. ^P / _S .. 50..	38.12	52.62	55.97	41.24	26.93	23.54	39.63

Note : toutes les dimensions sont en mm / all dimensions are in mm

851 Series



Embase à collerette ronde, fixation par brasage Solder fixing receptacle

IH	HE 301 B 1H
	MS 3113 H
	VG 95328 G



Taille de boîtier Shell size	Références / Part numbers	A	D max	H max	F	G max	M max	N max
8	851 IH 8 .. P _S . 50..	12.03	16.40	8.19	13.84	14.27	10.69	0.76
10	851 IH 10 .. P _S . 50..	15.01	19.40	8.19	13.84	17.06	10.69	0.76
12	851 IH 12 .. P _S . 50..	19.07	21.80	8.19	13.84	19.83	10.69	0.76
14	851 IH 14 .. P _S . 50..	22.25	25.00	8.19	13.84	23.00	10.69	0.76
16	851 IH 16 .. P _S . 50..	25.42	28.10	8.19	13.84	26.18	10.69	0.76
18	851 IH 18 .. P _S . 50..	28.60	31.30	8.19	13.84	29.36	10.69	0.76
20	851 IH 20 .. P _S . 50..	31.77	33.70	8.16	15.42	31.74	12.32	0.76
22	851 IH 22 .. P _S . 50..	34.95	36.90	8.16	16.23	34.92	12.32	0.76
24	851 IH 24 .. P _S . 50..	38.12	40.10	7.36	17.04	38.10	13.12	0.76

Connecteurs pour connexions enroulées et à picots droits Wire-wrap and PC tail connectors

Embase à collerette carrée type 02E Square flange receptacle type 02E

Version pour connexions enroulées (WW)
Wire-wrap version



Version à picots droits
PC tail version

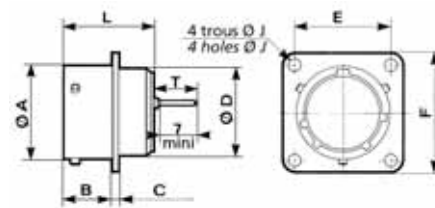

Taille de boîtier Shell size	Références / Part numbers		A	B max	C max	Ø D max	E	F max	H +163 0	J	L max	T +125 0
	version WW WW version	version à picots PC tail version										
8	851 02 E 8.. P _S . 50.. ³⁴ _{34A}	851 02 E 8.. P _S . 50.. ¹⁶ ₄₀	12.03	11.70	1.32	10.84	15.09	20.99	12.42	3.13	20.50	9.46
10	851 02 E 10.. P _S . 50.. ³⁴ _{34A}	851 02 E 10.. P _S . 50.. ¹⁶ ₄₀	15.01	11.70	1.32	13.99	18.26	24.19	12.42	3.13	20.50	9.46
12	851 02 E 12.. P _S . 50.. ³⁴ _{34A}	851 02 E 12.. P _S . 50.. ¹⁶ ₄₀	19.07	11.70	1.32	17.37	20.62	26.54	12.42	3.13	20.50	9.46
14	851 02 E 14.. P _S . 50.. ³⁴ _{34A}	851 02 E 14.. P _S . 50.. ¹⁶ ₄₀	22.25	11.70	1.32	20.57	23.00	28.89	12.42	3.13	20.50	9.46
16	851 02 E 16.. P _S . 50.. ³⁴ _{34A}	851 02 E 16.. P _S . 50.. ¹⁶ ₄₀	25.42	11.70	1.32	23.62	24.61	31.29	12.42	3.13	20.50	9.46
18	851 02 E 18.. P _S . 50.. ³⁴ _{34A}	851 02 E 18.. P _S . 50.. ¹⁶ ₄₀	28.60	11.70	1.32	26.69	26.97	33.69	12.42	3.13	20.50	9.46
20	851 02 E 20.. P _S . 50.. ³⁴ _{34A}	851 02 E 20.. P _S . 50.. ¹⁶ ₄₀	31.77	14.35	2.15	29.89	29.36	36.89	10.69	3.13	23.80	7.76
22	851 02 E 22.. P _S . 50.. ³⁴ _{34A}	851 02 E 22.. P _S . 50.. ¹⁶ ₄₀	34.95	14.35	2.15	33.04	31.75	39.99	10.69	3.13	23.80	7.76
24	851 02 E 24.. P _S . 50.. ³⁴ _{34A}	851 02 E 24.. P _S . 50.. ¹⁶ ₄₀	38.12	15.20	2.15	36.24	34.92	43.15	10.69	3.81	23.80	7.76

Note : toutes les dimensions sont en mm / all dimensions are in mm

851 Series



Embase à fixation par écrou type 07A Jam nut receptacle type 07A

Version pour connexions enroulées (WW)
Wire-wrap version



Version à picots droits
PC tail version



Taille de boîtier Shell size	Références / Part numbers		A	B max	C max	F max	H +163 0	L max	P max	S max	T +125 0
	version WW WW version	version à picots PC tail version									
8	851 07 A 8.. ^P _S .50.. ³⁴ _{34A}	851 07 A 8.. ^P _S .50.. ¹⁶ ₄₀	12.03	17.90	2.64	26.94	12.42	20.64	19.29	23.94	9.46
10	851 07 A 10.. ^P _S .50.. ³⁴ _{34A}	851 07 A 10.. ^P _S .50.. ¹⁶ ₄₀	15.01	17.90	2.64	30.14	12.42	20.64	22.38	26.95	9.46
12	851 07 A 12.. ^P _S .50.. ³⁴ _{34A}	851 07 A 12.. ^P _S .50.. ¹⁶ ₄₀	19.07	17.90	2.64	34.94	12.42	20.64	27.13	31.74	9.46
14	851 07 A 14.. ^P _S .50.. ³⁴ _{34A}	851 07 A 14.. ^P _S .50.. ¹⁶ ₄₀	22.25	17.90	2.64	38.04	12.42	20.64	30.33	34.94	9.46
16	851 07 A 16.. ^P _S .50.. ³⁴ _{34A}	851 07 A 16.. ^P _S .50.. ¹⁶ ₄₀	25.42	17.90	2.64	41.26	12.42	20.64	33.48	38.24	9.46
18	851 07 A 18.. ^P _S .50.. ³⁴ _{34A}	851 07 A 18.. ^P _S .50.. ¹⁶ ₄₀	28.60	17.90	2.64	44.44	12.42	20.64	36.68	41.34	9.46
20	851 07 A 20.. ^P _S .50.. ³⁴ _{34A}	851 07 A 20.. ^P _S .50.. ¹⁶ ₄₀	31.77	22.45	3.44	49.14	8.64	25.99	39.83	46.04	8.49
22	851 07 A 22.. ^P _S .50.. ³⁴ _{34A}	851 07 A 22.. ^P _S .50.. ¹⁶ ₄₀	34.95	22.45	3.44	52.24	8.64	25.99	43.03	49.24	8.49
24	851 07 A 24.. ^P _S .50.. ³⁴ _{34A}	851 07 A 24.. ^P _S .50.. ¹⁶ ₄₀	38.12	23.30	3.44	55.54	7.79	26.84	46.18	52.74	7.79

Perçage cloison / Panel cut-out

Embase à collerette carrée
Square flange receptacle



Embase à fixation par écrou
Jam nut receptacle



Embase à collerette ronde
Solder fixing receptacle



Taille de boîtier Shell size	A ^{±0.1}	B ^{±0.1}	C ^{±0.1}	E ^{±0.15}	J ^{±0.15}	N		p ^{±0.1}	X min
						min	max		
8	15.55	14.60	14.70	15.10	3.15	1.57	3.17	13.75	2.90
10	18.80	17.75	17.50	18.26	3.15	1.57	3.17	16.95	2.90
12	22.15	22.50	20.20	20.62	3.15	1.57	3.17	21.50	2.90
14	25.30	25.70	23.40	23.00	3.15	1.57	3.17	24.20	2.90
16	28.45	28.85	26.60	24.60	3.15	1.57	3.17	27.35	2.90
18	31.65	32.05	29.80	26.97	3.15	1.57	3.17	30.55	2.90
20	34.80	35.20	32.10	29.36	3.15	1.57	6.35	33.70	5.50
22	38.00	38.40	35.30	31.75	3.15	1.57	6.35	36.90	5.50
24	41.20	41.55	38.40	34.92	3.73	1.57	6.35	40.05	5.50

Note : toutes les dimensions sont en mm / all dimensions are in mm



Accessoires / Accessories

Embase de repos / Dummy receptacle

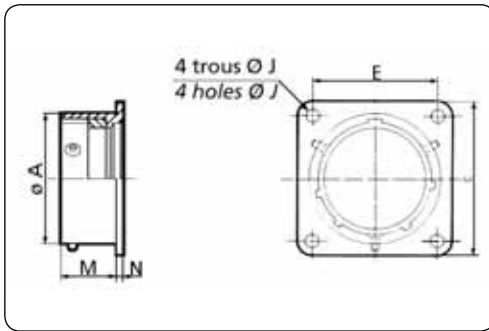

Taille de boîtier Shell size	Références Part numbers	A	C max	E	J	M max	N max
8	8500-18	12.03	20.99	15.09	3.13	11.70	1.32
10	8500-19	15.01	24.19	18.26	3.13	11.70	1.32
12	8500-20	19.07	26.54	20.62	3.13	11.70	1.32
14	8500-21	22.25	28.89	23.00	3.13	11.70	1.32
16	8500-26	25.42	31.29	24.61	3.13	11.70	1.32
18	8500-22	28.60	33.69	26.97	3.13	11.70	1.32
20	8500-23	31.77	36.89	29.36	3.13	14.35	2.15
22	8500-24	34.95	39.99	31.75	3.13	14.35	2.15
24	8500-25	38.12	43.15	34.92	3.81	15.20	2.15

Bouchons de protection plastique pour embase & fiche Plastic protective caps for receptacle and plug

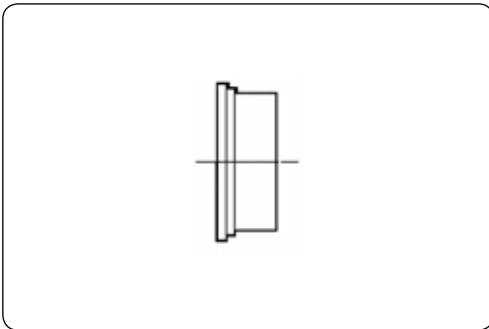

Taille de boîtier Shell size	Bouchons pour embase Caps for receptacles	Bouchons pour fiches Caps for plugs
8	8500-5585 A	8500-5594
10	8500-5586 A	8500-5595
12	8500-5587 A	8500-5596
14	8500-5588 A	8500-5597
16	8500-5589 A	8500-5598
18	8500-5590 A	8500-5599
20	8500-5591 A	8500-5600
22	8500-5592 A	8500-5601
24	8500-5593 A	8500-5602

Joint de cloison / Gaskets

Taille de boîtier Shell size	Joints pour embase à collerette carrée / Gaskets for square flange receptacle		Joints pour embase à fixation par écrou / Gaskets for jam nut receptacle	
	néoprène	fairprène	néoprène	vitton
8	8500-275	8500-4164	3330102	3330675
10	8500-276	8500-4165	3330103	3330670
12	8500-277	8500-4166	3330104	3330671
14	8500-278	8500-4167	3330105	3330672
16	8500-283	8500-4168	3330106	3331048
18	8500-279	8500-4169	3330107	3331049
20	8500-280	8500-4170	3330108	3331050
22	8500-281	8500-4171	3330109	3331051
24	8500-282	8500-4172	3330110	3331052

851 Series



Bouchons / Caps

Références / Ordering Information

Racine / Basic series								8500	05	---
Type de boîtier / Shell size	8	10	12	14	16	18	20	22	24	
Référence pour embase / Part numbers for receptacle	02	03	04	05	27	06	07	08	09	
Référence pour fiche / Part numbers for plug	10	11	12	13	28	14	15	16	17	

Spécifications / Specifications
pour type de bouchon & protection, voir tableau ci-dessous / for cap & plating, see table below

Types et protections / Type and plating

Type de bouchon Cap type	Bouchons pour embase / Receptacle cap				Bouchons pour fiche / Plug cap			
	Cadmiage vert olive Olive green cadmium	Cadmium incolore White cadmium	Oxydation noir Black anodised	Nickelage Nickel	Cadmiage vert olive Olive green cadmium	Cadmium incolore White cadmium	Oxydation noir Black anodised	Nickelage Nickel
Bouchon avec chaînette métallique et oeillet de fixation Cap with chain and ring	D	02 D	29 D	44 D	D	02 D	29 D	44 D
Bouchon avec cordonnet nylon et oeillet de fixation Cap with nylon cord and ring	B	02 B	29 B	44 B	B	02 B	29 B	44 B
Bouchon avec cordonnet nylon et rondelle de fixation (boîtier 10, 12, 14, 16 & 18) Cap with nylon cord and washer (shell 10, 12, 14, 16 & 18)	-	-	-	-	E	-	-	-
Bouchon avec cordonnet nylon et rondelle de fixation Cap with nylon cord and washer	H	-	-	44 H	-	-	-	-
Bouchon avec chaînette métallique et rondelle de fixation Cap with chain and washer	J	-	-	-	-	-	-	-
Bouchon 500 H brouillard salin Cap 500hr salt spray	JQ7	-	-	-	-	-	-	-
Bouchon sans cordonnet Cap without chain	M	-	-	-	M	-	-	-

Bouchons pour fiches / Caps for plugs

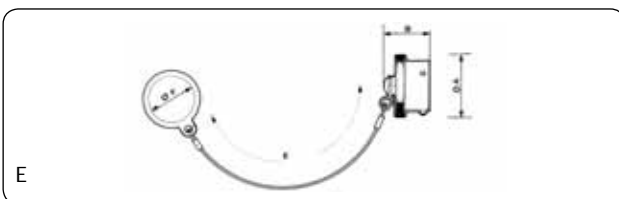
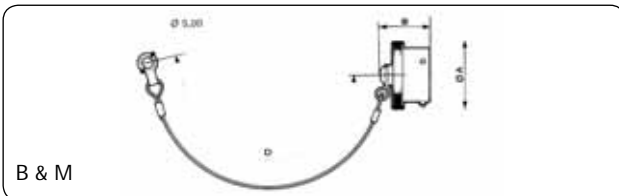
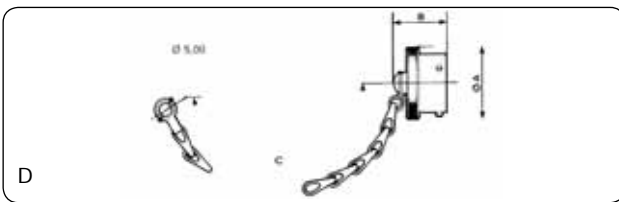

Taille de boîtier Shell size	Ø A max	B max	C ⁺⁶	D ⁺²	E	Ø F
8	16.80	19.84	132	128	-	-
10	19.80	19.84	132	128	132	14.00
12	23.90	19.84	148	140	148	17.60
14	27.00	19.84	148	140	148	20.80
16	30.20	19.84	148	140	148	25.60
18	33.40	19.84	148	140	148	28.70
20	36.50	21.44	168	153	-	-
22	39.80	21.44	168	153	-	-
24	42.90	22.22	168	153	-	-

« - » nous contacter / consult us

Note : toutes les dimensions sont en mm / all dimensions are in mm



851 Series

Bouchons pour embases / Caps for receptacles

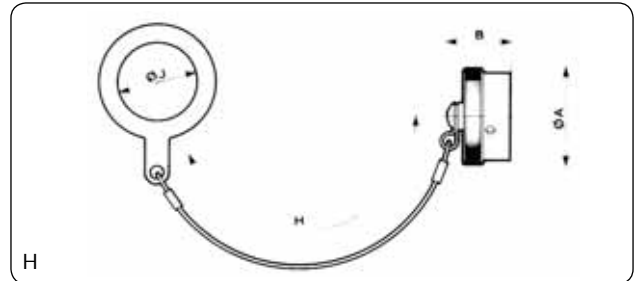
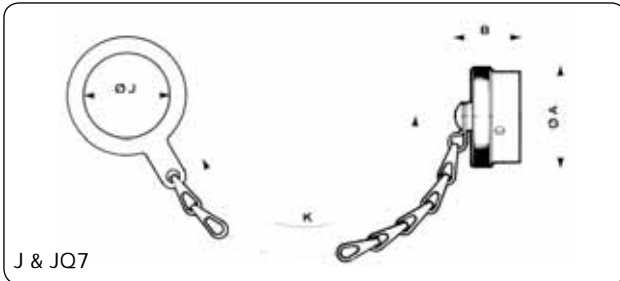
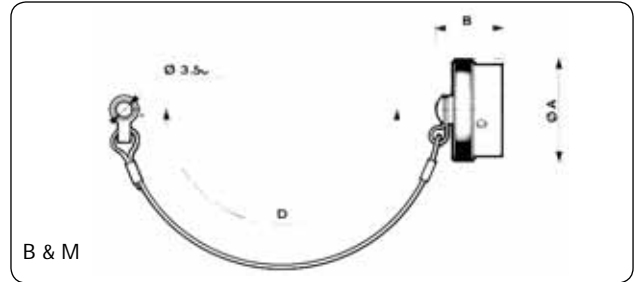
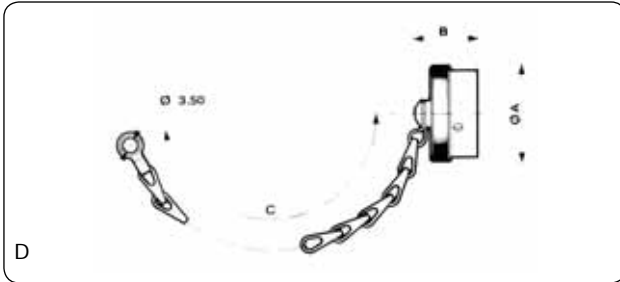

Taille de boîtier Shell size	Ø A max	B max	C ⁺⁶ ₀	D ⁺² ₀	J max	H ⁺² ₀	K ⁺⁶ ₀
8	19.00	21.44	84	77	14.80	80	84
10	21.80	21.44	84	77	17.90	80	84
12	26.10	21.44	100	89	22.70	90	100
14	29.30	21.44	100	89	25.90	90	100
16	32.50	21.44	100	89	29.00	90	100
18	35.30	21.44	100	89	32.20	90	100
20	38.80	21.44	116	102	35.40	110	116
22	42.00	21.44	116	102	38.60	110	116
24	45.10	22.22	116	102	41.70	110	116

Note : toutes les dimensions sont en mm / all dimensions are in mm

851 Series



Références des raccords / Backshell ordering information

Pour les types de protection voir références page 11 / For plating types see part numbers page 11

Raccords droits / Straight backshells	taille de boîtier Shell size		protection plating	8	10	12	14	16	18	20	22	24
	désignation designation	écrou nut P/RP										
raccord simple backnut	E/R	-	8500-5882 LP	8500-5883 LP	8500-5884 LP	8500-5885 LP	8500-5886 LP	8500-5887 LP	8500-5888 LP	8500-5889 LP	8500-5890 LP	
		29 ou/ou 031	8500-5882 110	8500-5883 110	8500-5884 110	8500-5885 110	8500-5886 110	8500-5887 110	8500-5888 110	8500-5889 110	8500-5890 110	
		44	8500-5882 202	8500-5883 202	8500-5884 202	8500-5885 202	8500-5886 202	8500-5887 202	8500-5888 202	8500-5889 202	8500-5890 202	
raccord droit à serre-câbles straight cable clamp	EC AC/RC	-	8500-2469 900	8500-2470 900	8500-2471 900	8500-2472 900	8500-2473 900	8500-2474 900	8500-2475 900	8500-2476 900	8500-2477 900	
		29 ou/ou 031	8500-2469 902	8500-2470 902	8500-2471 902	8500-2472 902	8500-2473 902	8500-2474 902	8500-2475 902	8500-2476 902	8500-2477 902	
		44	8500-2469 903	8500-2470 903	8500-2471 903	8500-2472 903	8500-2473 903	8500-2474 903	8500-2475 903	8500-2476 903	8500-2477 903	
raccord droit pour potting straight backshell for potting	écrou nut P/RP	-	8500-1559 LP	8500-1560 LP	8500-1561 LP	8500-1562 LP	8500-1563 LP	8500-1564 LP	8500-1565 LP	8500-1566 LP	8500-1567 LP	
		P	8500-466	8500-467	8500-468	8500-469	8500-470	8500-471	8500-472	8500-473	8500-474	
		Potting RP	8500-682	8500-683	8500-684	8500-685	8500-686	8500-687	8500-688	8500-689	8500-690	
raccord droit intermédiaire straight adaptor	A/RA	-	8500-448 LP	8500-449 LP	8500-450 LP	8500-451 LP	8500-452 LP	8500-453 LP	8500-454 LP	8500-455 LP	8500-456 LP	
		29 ou/ou 031	-	-	-	-	-	-	-	-	-	-
		44	-	-	-	-	-	-	-	-	-	-
raccord droit pour gaine thermorétractable straight backshell for heatshrink sleeving	T/RT	-	8500-4021 LP	8500-4022 LP	8500-4023 LP	8500-4024 LP	8500-4025 LP	8500-4026 LP	8500-4027 LP	8500-4028 LP	8500-4029 LP	
		29 ou/ou 031	8500-4021 110	8500-4022 110	8500-4023 110	8500-4024 110	8500-4025 110	8500-4026 110	8500-4027 110	8500-4028 110	8500-4029 110	
		44	-	-	-	-	-	-	-	-	-	-
raccord droit démontable pour gaine thermorétractable removable straight backshell for heatshrink sleeving	M/RM	-	8500-4245 900	8500-4246 900	8500-4247 900	8500-4248 900	8500-4249 900	8500-4250 900	8500-4251 900	8500-4252 900	8500-4253 900	
		29 ou/ou 031	-	-	-	-	-	-	-	-	-	-
		44	-	-	-	-	-	-	-	-	-	-
raccord droit démontable pour reprise de tresse et gaine thermorétractable removable straight backshell for screen termination and heatshrink sleeving	G/RG	-	8501-0188 900	8500-8977 900	8501-0189 900	8500-8978 900	8501-0190 900	8500-8979 900	8501-0190 903	8500-8980 900	8501-0190 903	8500-8981 900
		29 ou/ou 031	-	-	-	-	-	-	-	-	-	-
		44	8501-0188 903	8500-8977 903	8501-0189 903	8500-8978 903	8501-0190 903	8500-8979 903	8501-0190 903	8500-8980 903	8501-0190 903	8500-8981 903
raccord droit démontable pour reprise de tresse et gaine thermorétractable removable straight backshell for screen termination and heatshrink sleeving	T/RT	38	851 T 08-38	851 T 10-38	851 T 12-38	851 T 14-38	851 T 16-38	851 T 18-38	851 T 20-38	851 T 22-38	851 T 24-38	
		42	851 T 08-42	851 T 10-42	851 T 12-42	851 T 14-42	851 T 16-42	851 T 18-42	851 T 20-42	851 T 22-42	851 T 24-42	
		specifica- tion 38 & 42										
raccord droit à presse-étoupe straight sealing gland backshell	J	presse- étoupe sealing gland	8500-5873	8500-5874	8500-5875	8500-5876	8500-5877	8500-5878	8500-5879	8500-5880	8500-5881	
			8500-5900 LP	8500-5901 LP	8500-5902 LP	8500-5903 LP	8500-5904 LP	8500-5905 LP	8500-5906 LP	8500-5907 LP	8500-5908 LP	
			écrou nut									



Références des raccords / Backshell ordering information

Pour les types de protection voir références page 11 / For plating types see part numbers page 11

Raccords droits / Straight backshells	taille de boîtier / shell size											
	désignation / designation	protection / plating	8	10	12	14	16	18	20	22	24	
raccord droit à presse-étoupe et serre-câbles / straight sealing gland and cable clamp backshell	JC	presse-étoupe / sealing gland	8500-5873	8500-5874	8500-5875	8500-5876	8500-5877	8500-5878	8500-5879	8500-5880	8500-5881	
		écrou / nut	8500-5989 900	8500-5990 900	8500-5991 900	8500-5992 900	8500-5993 900	8500-5994 900	8500-5995 900	8500-5996 900	8500-5997 900	
raccord droit court pour reprise de tresse et gaine thermorétractable / short backshell for screen termination and heatshrink sleeving		U/RU 29 ou/ou 031 44	-	-	8500-8474 900	8500-8475 900	8500-8476 900	-	-	-	-	
raccord pour adaptation d'accessoire au pas électrique / straight adaptor for electrical pitch access		Z/RZ 29 ou/ou 031 44	-	-	8500-8185 LP	8500-8186 LP	8500-8187 LP	8500-8188 LP	8500-8189 LP	8500-8190 LP	8500-8191 A LP	

Raccords droits pour embase 07 / Straight backshells for receptacle 07

raccord simple / backnut	E/R	29 ou/ou 031 44	8500-374 LP	8500-374 LP	8500-375 LP	8500-376 LP	8500-377 LP	8500-378 LP	8500-379 LP	8500-380 LP	8500-381 LP
			8500-374 110	8500-374 110	8500-375 110	8500-376 110	8500-377 110	8500-378 110	8500-379 110	8500-380 110	8500-381 110
			8500-374 202	8500-374 202	8500-375 202	8500-376 202	8500-377 202	8500-378 202	8500-379 202	8500-380 202	8500-381 202
raccord droit à serre-câbles / straight cable clamp	EC / RC	29 ou/ou 031 44	8500-8351 900	8500-1790 900	8500-1791 900	8500-1792 900	8500-1793 900	8500-1794 900	8500-1795 900	8500-1796 900	8500-1797 900
			-	-	-	-	-	-	-	-	-
raccord droit pour potting / straight backshell for potting	P		8500-466	8500-467	8500-468	8500-469	8500-470	8500-471	8500-472	8500-473	8500-474
	RP		8500-682	8500-683	8500-684	8500-685	8500-686	8500-687	8500-688	8500-689	8500-690
raccord droit pour gaine thermorétractable / straight backshell for heatshrink sleeving	T/RT	29 ou/ou 031 44	8500-4776 LP	8500-4777 LP	8500-4778 LP	8500-4779 LP	8500-4780 LP	8500-4781 LP	8500-4782 LP	8500-4783 LP	8500-4784 LP
			8500-4776 110	8500-4777 110	8500-4778 110	8500-4779 110	8500-4780 110	8500-4781 110	8500-4782 110	8500-4783 110	8500-4784 110

Raccords coudés / Elbow backshells

raccord coudé à serre-câbles / elbow cable clamp backshell	EC/RC	29 ou/ou 031 44	8500-791 900	8500-792 900	8500-793 900	8500-794 900	8500-795 900	8500-796 900	8500-799 900
			8500-791 902	8500-792 902	8500-793 902	8500-794 902	8500-795 902	8500-796 902	8500-3225 902



Outillages / Tools

Outillage de sertissage / Crimping pliers

Tailles de contacts Contact sizes	Section de câbles / Wire sizes		Références / Part numbers	
	mm ²	AWG	pince à sertir / crimping tool	positionneur / locator
20	0.93	18	8476-01 (M 22520/2-01) 8365 (M 22520/1-01)	8476-02 (M 22520/2-02) 8365-02 (M 22520/1-02)
	0.60	20		
	0.38	22		
	0.21	24		
16	1.91	14	8365 (M 22520/1-01)	8365-02 (M 22520/1-02)
	1.34	16		
	0.93	18		

Outillage d'insertion et d'extraction / Insertion and extraction tools

Type de contacts Contact types	Tailles de contacts Contact sizes	Références / Part numbers	
		outil d'insertion / insertion tools	outil d'extraction / extraction tools
à sertir crimp	20	8500-29B*	8500-36A
	16	8500-39	8500-38A
pour connexion enroulée for wire-wrap	20	8500-31	8500-31
	16	8500-39 ou/ or 8500-37	8500-37

Tube de rechange pour outil / Square tube for tool :

- 8500-36A : ref. 8500-1163
- 8500-38A : ref. 8500-1486 021

* Sauf arrangements 8-2, 8-3, 8-4, 12-14 : outil 8500-93B

* Except 8-2, 8-3, 8-4, 12-14 contact layouts : insertion tool 8500-93B

Obturateurs / Filler plugs

Tailles de contacts Contact sizes	Références / part numbers	Couleur / Colour	Profil / Profile
20	8500-4144	gris / grey	
16	8500-479	bleu / blue	
20	8500-4144 A (MS 3187 A 20)	rouge / red	
16	8500-4267 (MS 3187-16)	bleu / blue	



851 Series

Outils de sertissage / Crimping pliers

8476-01 (M 22520/2-01)
avec / with
8476-02 (M 22520/2-02)



8365 (M 22520/1-01)
avec / with
8365-02 (M 22520/1-02)



Outils de d'insertion / Insertion tools

8500-39



8500-29B





851 Series

Outils d'extraction / *Extraction tools*

8500-36 A (Contact à sertir #20 / Crimp contact #20)
8500-38 A (Contact à sertir #16 / Crimp contact #16)



8500-31 (pour connexion enroulée #20 / *for wire-wrap #20*)
8500-37 (pour connexion enroulée #16 / *for wire-wrap #16*)



Accessoires / *Accessories*

8498-04
Clé à sangle pour serrage
des accessoires arrière
*Strap backshell tightening
spanner*



8500-30
Support de serrage
Tightening support





Notice de câblage / Wiring instructions

Préparation des câbles / cable preparation

Contacts à sertir

Dénudage

- Apporter le plus grand soin à cette opération. Utiliser une pince à dénuder appropriée à la section du câble et en parfait état.
- Afin de conserver toutes les caractéristiques d'étanchéité du connecteur et permettre un câblage rationnel, les fils doivent avoir les dimensions ci-dessous :

Taille des contacts	Ø sur gaine	
	min.	max.
20	1.20	2.11
16	1.60	2.80

- Taux de remplissage conseillé :
 - 50 % Ø maxi / 50 % Ø mini
 - 100 % Ø moyen
- Contacts de taille 20 pour les câbles de :
 - Ø sur gaine ≤ à 2 mm, dénuder sur une longueur de 4,5 mm
 - Ø sur gaine > à 2 mm, dénuder sur une longueur de 7 mm.
- Contacts de taille 16, dénuder le câble sur 6 mm.

Raccordement câbles-contacts

- Enfiler le câble dans le fût du contact et s'assurer que les brins du câble sont apparents dans le trou de visite.

Utilisation de l'embout réducteur

- Contacts de taille 20, si le câble a une section inférieure à 0,21 mm², il est indispensable d'intercaler un embout réducteur : réf. 8500-781.
- Contacts de taille 16, embout réducteur : réf. 8500-1985, si le câble a une section égale à 0,60 mm².

Crimp contacts

Stripping

- This operation should be carried out with great care. Use stripping pliers which are in good condition and which are designed for use with the size of wire being stripped.
- In order to maintain the connector's excellent sealing characteristics and, at the same time, meet the highest cabling standards the wires should have the following external sheath dimensions :

Contacts size	Ø over sheath	
	min.	max.
20	1.20	2.11
16	1.60	2.80

- Recommended loading :
 - 50 % with max. diam. wires / 50 % with min. diam. wires
 - 100 % with medium size wires.
- Size 20 contacts for cables :
 - when Ø over insulation ≤ 2 mm strip to a 4.5 mm length
 - when Ø over insulation > 2 mm strip to a 7-mm length.
- Size 16 contacts, strip the cable to a length of 6 mm.

Cable-contact assembly

- Insert the wire into the crimp barrel and ensure that it has penetrated correctly by checking that it may be seen through the lateral hole in the barrel.

Reducing sleeve

- If a wire with a cross sectional area of less than 0.21 mm² is used with a size 20 contact, it will be necessary to use a reducing sleeve : ref. 8500-781.
- Wires of cross sectional area of 0.6 mm² may be used with size 16 contacts by using a reducing sleeve, ref. 8500-1985.

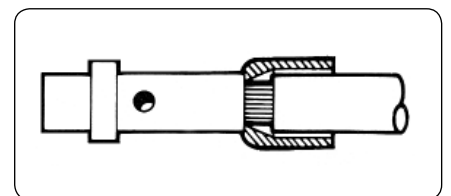
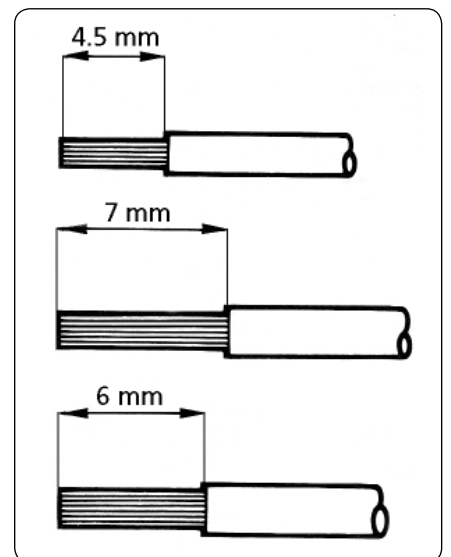
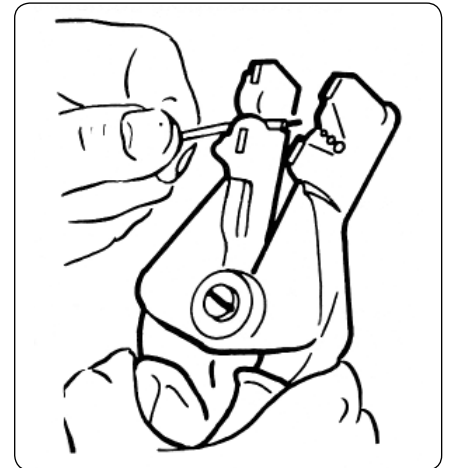

contact / contact

embout / sleeve

câble / cable





Sertissage des contacts / Contact crimping

- Avec pince à sertir MS 22520/1-01 référence Souriau 8365 et tourelle MS 22520/1-02 8365-02:
 - position «rouge» pour contact taille 20
 - position «bleue» pour contact taille 16.

- Avec pince à sertir MS 22520/2-01 référence Souriau 8476-01 et positionneur MS 22520/2-02 8476-02 :
 - contact taille 20 uniquement.

Nota : ne pas utiliser avec embout réducteur.

Les pinces doivent être utilisées côté poinçons.

- Presser sur les poignées de la pince jusqu'au déclic final, relâcher ; la pince doit s'ouvrir d'elle-même.
- Introduire l'ensemble fil et contact, ou fil embout réducteur et contact entre les 4 poinçons jusqu'à venir en butée dans le positionneur.
- Presser à fond jusqu'au déclic final, la pince doit s'ouvrir une fois le sertissage effectué.
- Extraire fil et contact serti et contrôler l'aspect du sertissage.

- *With crimping pliers MS 22520/1-01 Souriau part number 8365 and turret MS 22520/1-02 8365-02 :*
 - «red» position for size 20 contacts
 - «blue» position for size 16 contacts.

- *With crimping pliers MS 22520/2-01 Souriau part number 8476-01 and locator MS 22520/2-02 8476-02 :*
 - for size 20 contacts only.

Note : not be used with reducing sleeve.

Squeeze pliers firmly until a click is heard, the pliers should spring open when the ratched mechanism is released.

- *Hold indentor side up-insert the wire-contact assembly or mire-reducing sleeve-contact assembly between the four indentors, ensuring that the contact bottoms in the locator.*

- *Fully close the jaws, once the contact is crimped the pliers must spring open remove wire + crimped contact, check crimp aspect.*

8365



8476-01





851 Series

Insertion des contacts / *Crimp contact insertion*

Avant les opérations suivantes, démonter et enfilez sur les câbles l'accessoire arrière du connecteur.

Outils d'insertion

- Contacts taille 20* : pince 8500-29B
- Contacts taille 16 : outil 8500-39.

Utilisation des outils d'insertion

Engager manuellement le contact dans l'alvéole de l'isolant.

- Contacts de taille 20 : prendre le fil entre les 2 becs de la pince en butée sur l'arrière de la jupe du contact.
- Contacts de taille 16 : mettre la partie sertie du contact dans le bec de l'outil, l'extrémité de celui-ci venant en butée sur la collerette principale du contact.

Introduire chaque contact dans le logement de l'isolant en poussant dans l'axe jusqu'à l'accrochage du contact dans le clip.

Obturbateurs

Lorsque certains contacts ne sont pas câblés, afin de conserver les caractéristiques d'étanchéité, il est indispensable de prévoir un obturbateur à l'arrière du contact : le contact doit être monté dans son alvéole avant l'obturbateur.

* Sauf arrangements 8-2, 8-3, 8-4, 12-14 : outil 8500-93B

First disassemble and slide connector rear accessory over cables.

Insertion tools

- Size 20 contacts* : pliers 8500-29B
- Size 16 contacts : tool 8500-39.

Use of insertion tools

Manually insert the contact into the desired insert cavity.

- Size 20 contacts : insert the wire between the pliers jaws, the tip of the jaws butting the contact shoulder.
- Size 16 contacts : introduce the contact crimped section in the tool jaws, the tip of the tool butting against the contact main flange.

Introduce contacts one by one in insert cavities pushing straight in until the contact snaps into position and the clip ensures contact retention.

Filler plugs

Where certain contacts are unwired and where it is necessary to fully maintain the connector's sealing characteristics, a filler plug must be used. Note that the contact must be inserted before the filler plug.

* Except 8-2, 8-3, 8-4, 12-14 contact layouts : tool 8500-93B

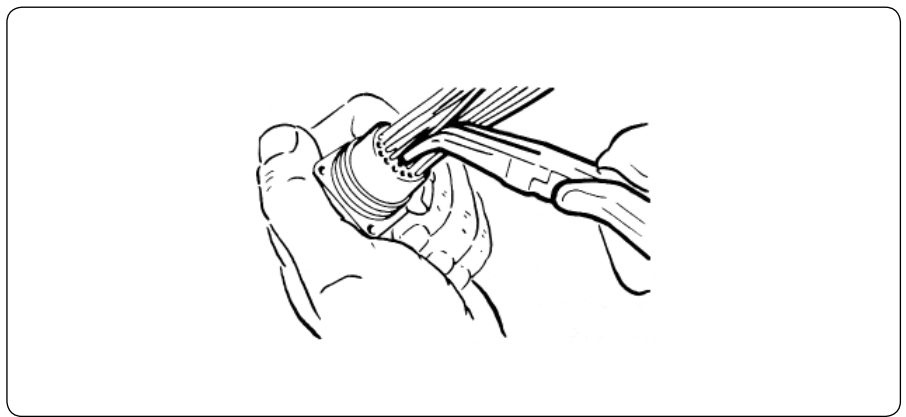
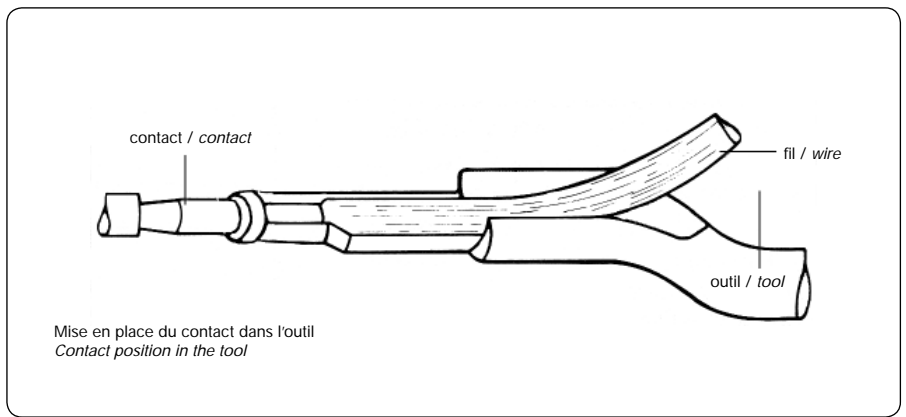
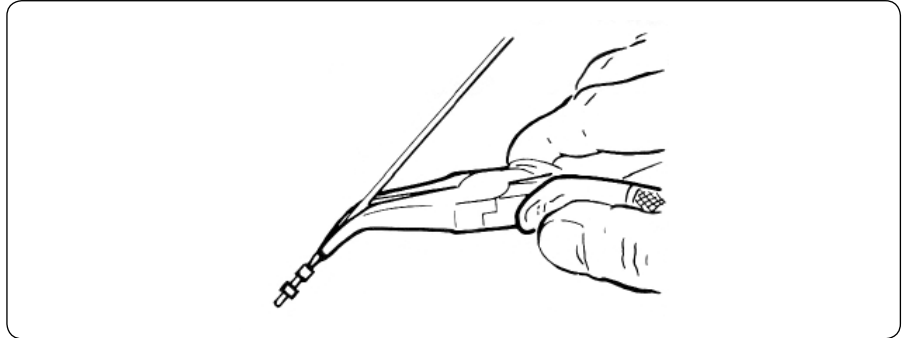



Extraction des contacts à sertir / *Crimp contact extraction*

Outils d'extraction

Tous les contacts pour isolants à clips sont démontables à l'aide d'un outil semi-automatique :

- contacts taille 20 : outil référence 8500-36A
- contacts taille 16 : outil référence 8500-38A.

Avant les opérations suivantes, démonter et faire glisser sur les câbles l'accessoire arrière du conducteur.

- Ne pas agir sur le poussoir de l'outil.
- Introduire par l'avant du connecteur (côté accouplement) le tube de l'outil sur le contact mâle ou femelle jusqu'au 1^{er} repère pour les contacts mâles et au 2^{ème} repère pour les contacts femelles.
- Cette opération doit être effectuée délicatement, dans l'axe du contact à l'aide d'un léger mouvement rotatif.
- Extraire le contact en actionnant le poussoir, retirer l'outil avec précaution et tirer sur le fil pour dégager l'ensemble fil-contact.

Nota : les outils possèdent un système à ressort réglable (par le bouton moleté arrière), permettant ainsi le décrochage automatique du contact.

Extraction tools

All contacts for use in insulators with clips are extracted using a semi-automatic tool :

- size 20 contacts : tool type 8500-36A
- size 16 contacts : tool type 8500-38A.

First disassemble and slide connector rear accessory over cables.

- Do not operate the tool slide button.
- Bring the tool tip over the male or female contact to be removed from connector front (mating face) as far as the first mark for male contacts and the second mark for female contacts.
- This operation, should be carried out delicately in a direction parallel to the contact centre line with a light turning action.
- Extract contact pushing the slide button fully forward, carefully remove tool and pull wire to release the wire-contact assembly.

Note : tools have an adjustable spring system (rear knurled knob) also for automatic contact disengagement.



851 Series



Schémas d'implantations pour circuits imprimés / Co-ordinates for PC tail contacts

Isolant mâle, vue face arrière (côté soudure) / Terminations viewed from male rear face (soldering side)

Ø trous de perçage 0,90 mm min. (# 20) + trous de perçage 1,3 mm min. (# 16)
tolérance de positionnement des trous sur carte / Hole size : 0.90 mm min. (# 20)
+ Hole sizes : 1.3 mm min. (# 16) hole position tolerance.

⊕	∅	0.10
---	---	------





851 Series

14-19

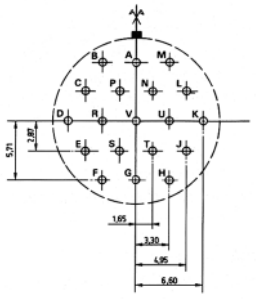

16-8

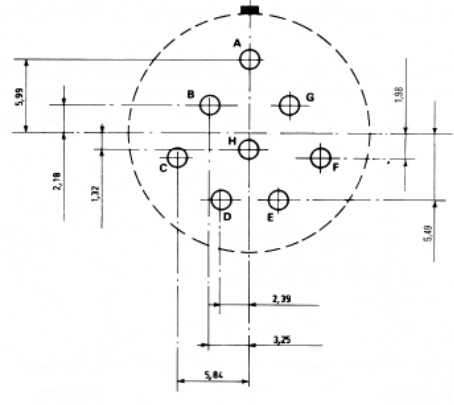

16-23

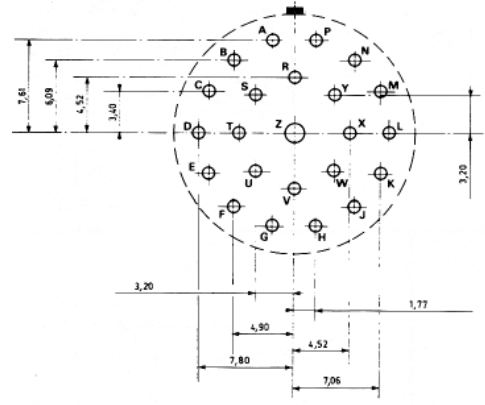

16-26

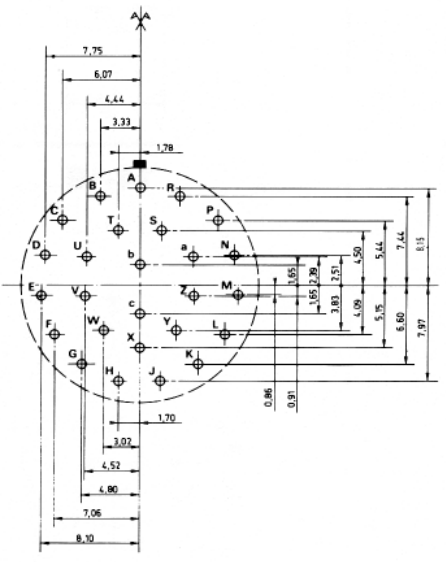

18-11

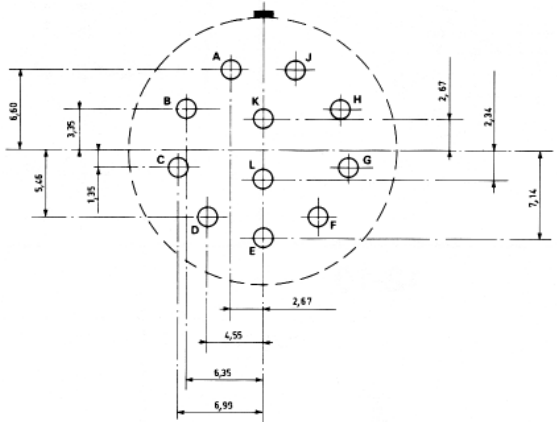

18-30

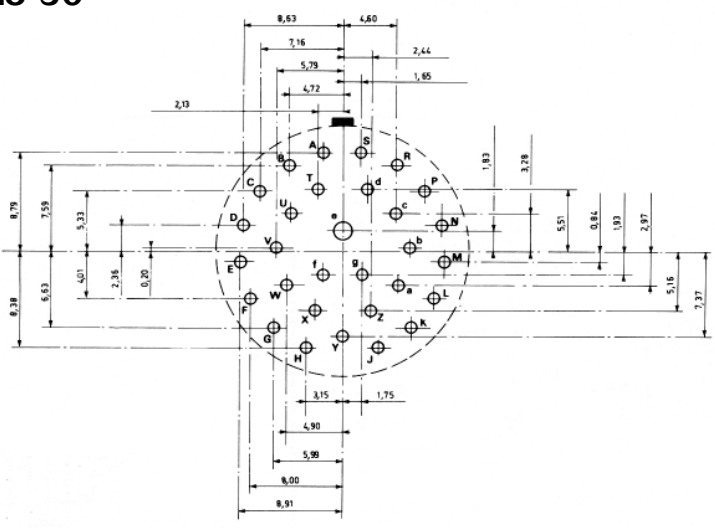

18-32

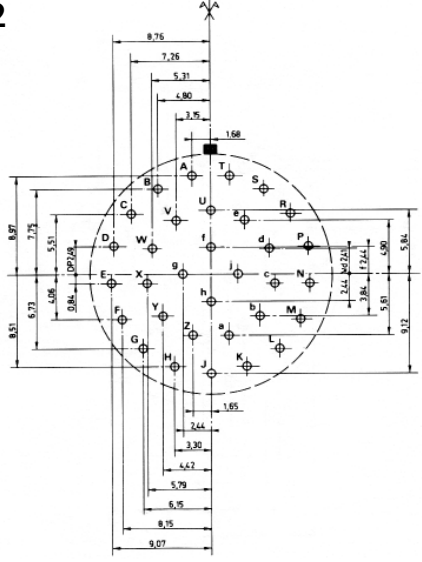

851 Series



20-16

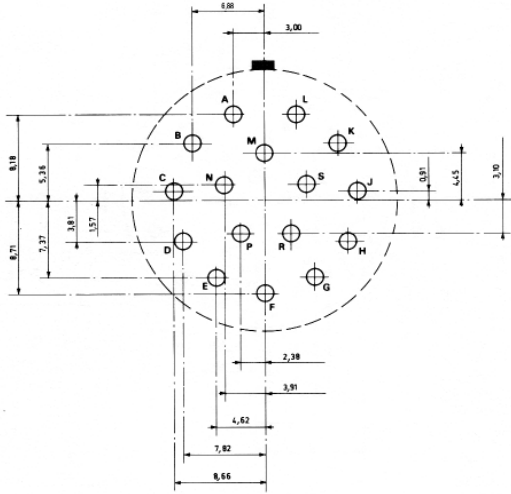

20-24

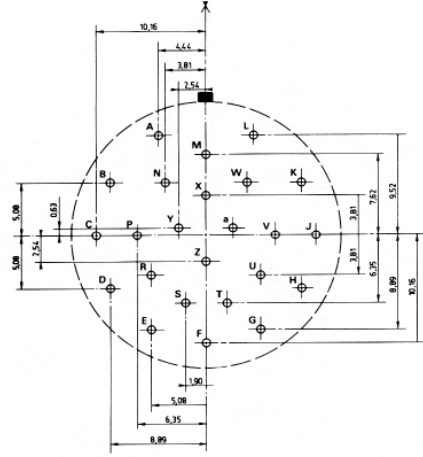

20-25

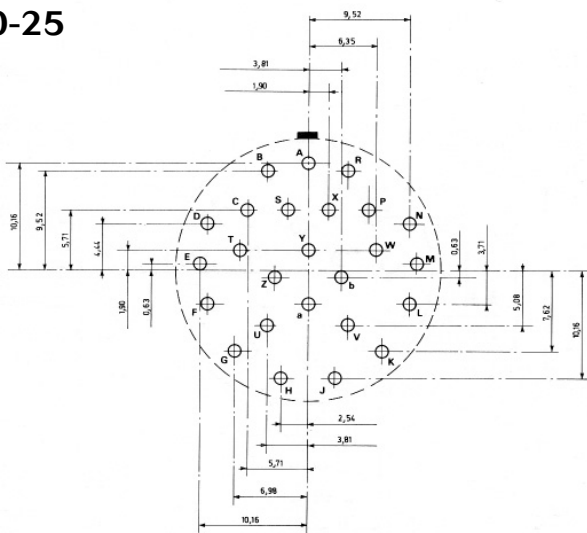

20-27



20-39

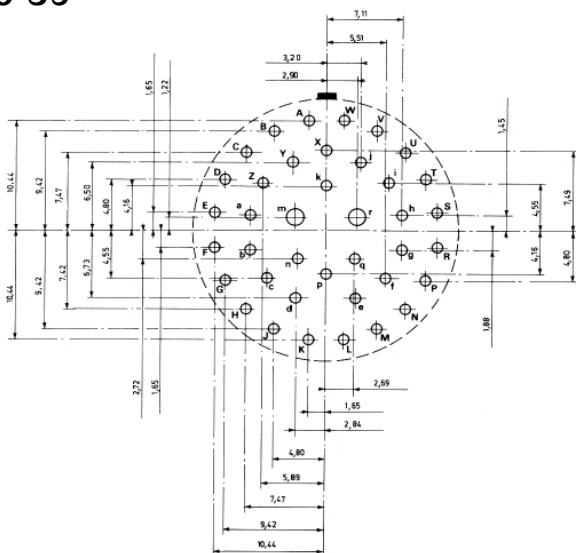

20-41

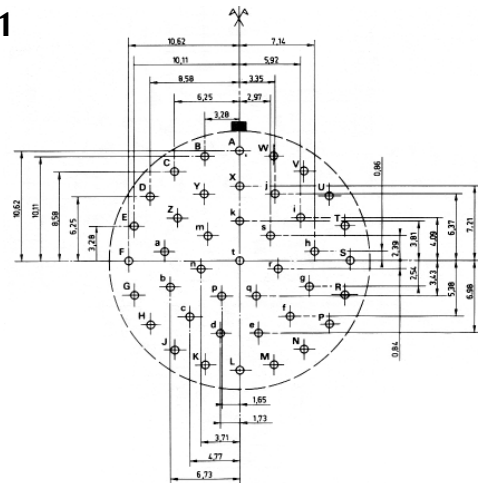



851 Series

22-21

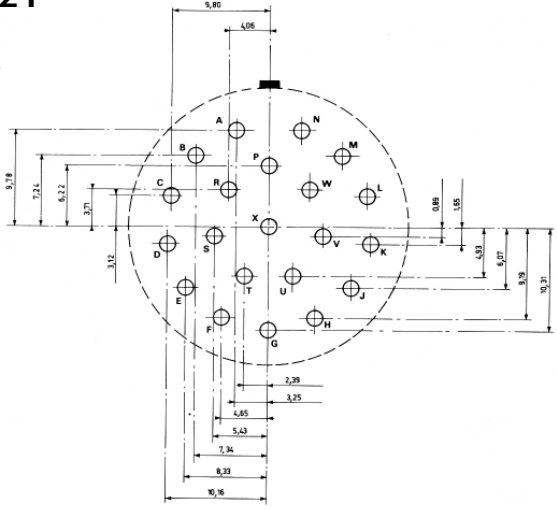

22-32

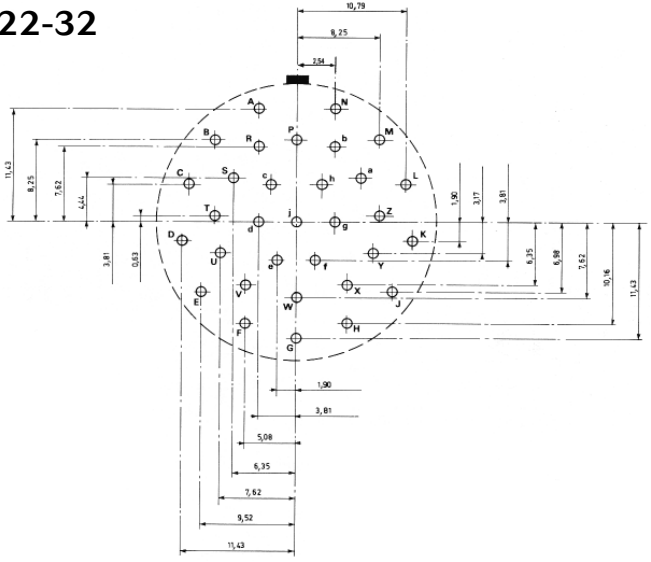

22-34

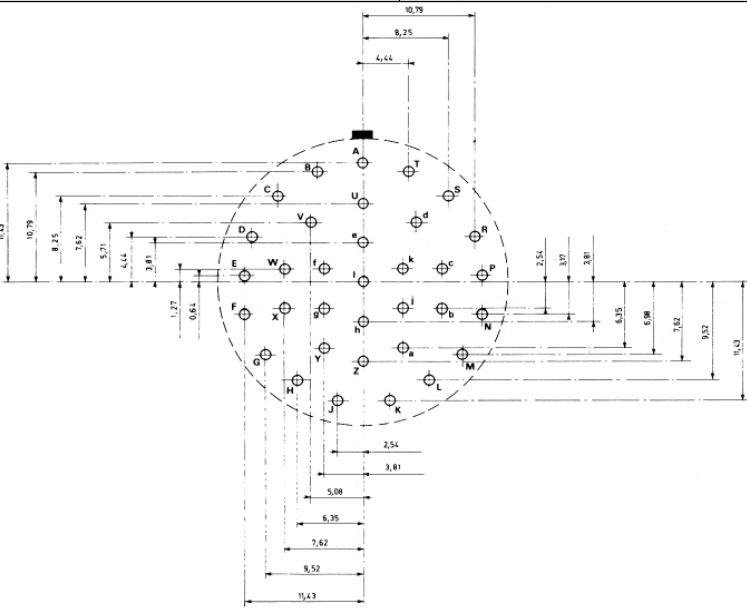

22-36

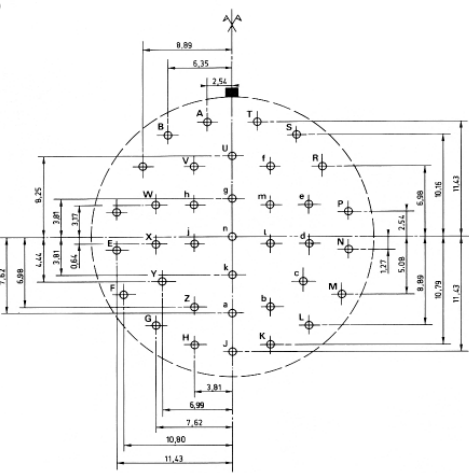

22-55

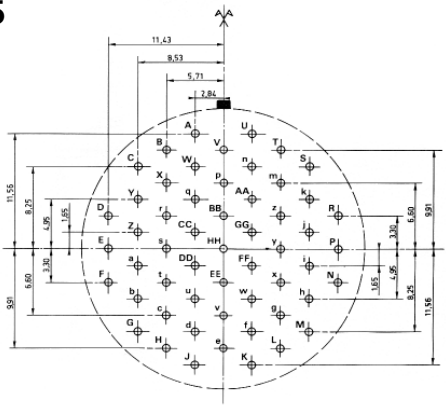

851 Series



24-61

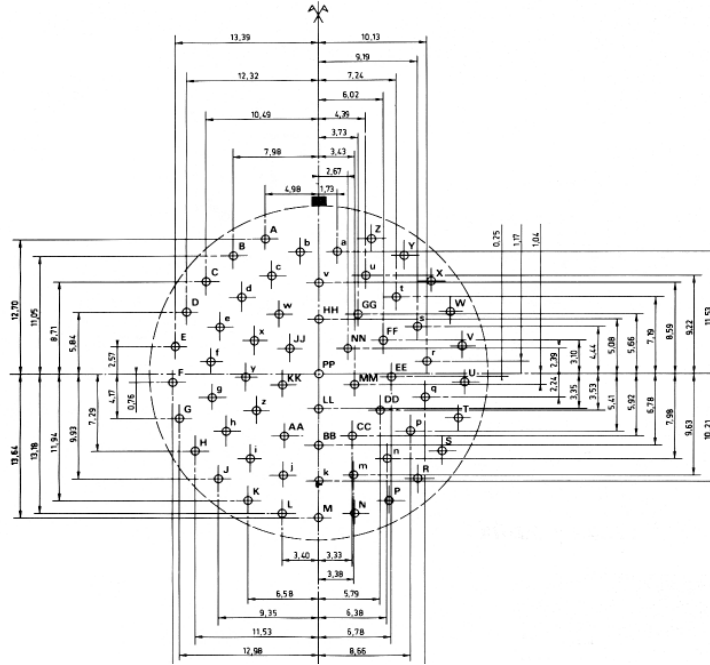



851 Series

Prise largable push-pull / Push-pull locking plug

Caractéristiques générales

- Verrouillage : en poussant sur la bague
- Déverrouillage : par traction sur la tirette de largage
- Montage : sur toutes les embases 851
- Arrangements et contacts à sertir et à souder : (voir pages 10 et 14/15)
- Autres caractéristiques : (voir page 9)

General characteristics

- Locking : by pushing on the coupling nut
- Unlocking : by pulling a lanyard
- Mounted : on all 851 receptacles
- Layouts and crimp solder contacts : (see pages 10 and 14/15)
- Other characteristics : (see page 9)

Références / Ordering information

Racine / Basic series	version à sertir - crimp version version à souder - solder version	856	06	R	••	••	P	•	50	••
		856	06	E	••	••	P	•	50	••
Type de boîtier / Shell type										
06	fiche droite - plug for use with straight backshell									
08	fiche coudée - plug for use with 90° backshell									
Type de raccord / Backshell type										
R/E	raccord simple / backnut									
RC/EC	raccord droit à serre-câbles / straight cable clamp									
RA/A	raccord droit intermédiaire / straight adaptor									
RP/P	raccord droit pour potting / straight backshell for potting									
RT/T	raccord droit pour gaine thermorétractable / straight backshell for heatshrink sleeving									
RM/M	raccord droit démontable pour gaine thermorétractable straight removable backshell for heatshrink sleeving									
*RT/*T	spécification 38 ou/or 42: raccord droit démontable pour reprise de tresse et gaine thermo- rétractable / straight removable backshell for screen termination and heatshrink sleeving									
RC/EC	raccord coudé à serre-câbles / 90° cable clamp									
Taille de boîtier / Shell size										
8 - 10 - 12 - 14 - 16 - 18 - 20 - 22 - 24										
Arrangements / Contact layouts										
Voir tableau des arrangements page 14/15 - See table page 14/15										
Type de contact/ Contact type										
P = mâle / male - S = femelle / female										
Positionnement / Orientation										
Normal (n'apparaît pas dans la référence) w, x, y, z - voir tableau page 16 Normal (not included in part number) w, x, y, z - see table page 16										
Indice obligatoire / Obligatory suffix										
Spécification / Specification										
07	protection cadmié vert olive (version à souder) olive-green cadmium plating (solder version)									
08	protection cadmié vert olive (version à sertir) olive green cadmium plating (crimp version)									
09	protection cadmié blanc (version à sertir et à souder) white cadmium plating (crimp and solder version)									

851 Series

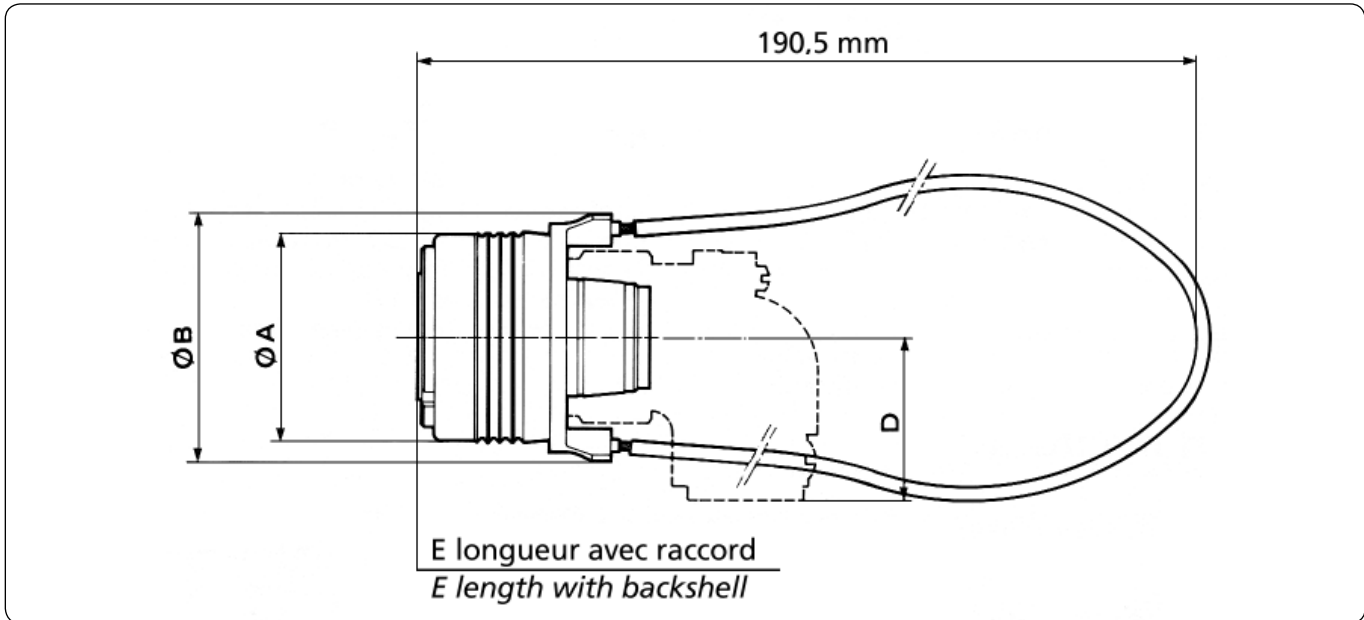

Dimensions		Taille de boîtier Shell size								
		8	10	12	14	16	18	20	22	24
	A	19.50	22.80	27.30	30.80	34.00	37.00	41.00	44.50	49.20
	B	24.95	28.25	32.55	36.05	39.05	42.05	45.80	49.20	53.45
06 R	E	32.00	32.00	32.00	32.00	32.00	32.00	31.80	31.80	31.80
06 RC	E	47.30	47.30	47.30	47.30	50.50	50.50	49.90	49.90	49.90
06 RP	E	42.10	42.10	42.10	42.10	42.10	45.40	49.80	49.80	49.80
06 RA	E	41.00	41.00	41.00	41.00	41.00	41.00	43.00	43.00	43.20
06 RM	E	50.00	50.00	50.00	50.00	50.00	50.00	51.70	51.70	51.70
06 RT spécifications 38 ou/or 42	E	50.00	50.00	50.00	50.00	50.00	50.00	51.70	51.70	51.70
08RC	E	50.10	52.60	54.90	58.50	60.80	65.00	68.80	71.20	76.20
	D max	16.00	18.00	19.50	22.00	23.50	25.00	26.50	28.00	31.00

Nota : Encombrements des raccords, se reporter aux dimensions des pages précédentes
 Note : For backshells dimensioning, refer to values given in preceding pages

Note : toutes les dimensions sont en mm / all dimensions are in mm



851 Series

Connecteurs filtres 8F51 / 8F51 filter connectors

Généralités

Ces connecteurs sont dérivés des spécifications standards MIL-DTL-26482 G série 1 - NFC 93422 (HE 301 B) - VG 95328.

Ils sont interchangeables en fixation et intermariables avec les connecteurs standards.

Différents types de filtres peuvent équiper ces connecteurs et permettent ainsi de supprimer les interférences RFI/EMI dans différentes gammes de fréquences.

L'utilisation de ces connecteurs à filtres performants incorporés offre les avantages suivants :

- Filtrage efficace des parasites à l'entrée ou à la sortie d'un équipement électronique,
- Ecran de blindage du coffret conservé,
- Encombrement et coût plus réduit par rapport à l'utilisation de filtres individuels câblés à l'arrière du connecteur,
- Choix de 4 types de contacts standards - merci de nous consulter pour tout autre valeur de capacitance et type de filtre,
- Possibilité de mixage de filtres dans le même arrangement : contacts filtrés, non filtrés et liés à la masse.

La version adaptateur, également disponible, permet d'équiper simplement les systèmes existants non filtrés.

Caractéristiques électriques

- Intensité max. par contact
7.5 A (#20); 13 A (#16)
- Tension max. de service
200 Vdc / 120 Vac
- Types de filtre standard
C, Pi
- Valeur de capacitance
typ. de 500 pF à 200 nF
- Performance filtre
Jusqu'à -60dB / -80dB

Consulter pour ce produit notre département CONNECTEURS FILTRES.

General information

These connectors are derived from standard specifications MIL-DTL-26482 G series 1 - NFC 93422 (HE 301 B) - VG 95328.

They are intermountable and intermateable with standard connectors.

Different types of filters may be fitted in these connectors to eliminate RFI/EMI in different frequency ranges.

Using built-in High Performance EMI filters offers the following advantages :

- *Efficient filtering on interferences at electronic equipment input or output,*
- *Case screen-shielding efficiency is maintained,*
- *Cost and volume saving as compared with the use of discrete filters wired down the line,*
- *4 types of standard filters are available - Please consult us for other capacitance and filter types,*
- *Combinations of mixed filter in the same layout: filtered, non-filtered and grounded contacts available.*

An adaptor version is also a simple technique to equip existing systems which do not incorporate filters.

Electrical characteristics

- *Max. current rating per contact
7.5 A (#20); 13 A (#16)*
- *Max. operating voltage
200 Vdc / 120 Vac*
- *Standard filter types
C, Pi*
- *Capacitance range
typically 500 pF - 200 nF*
- *Filter performance
up to -60dB / -80dB*

For this product, consult our FILTER CONNECTOR department.



851 Series

Connecteurs spécifiques et accessoires de connexion SNC SNC specific connectors and connection accessories

Désignations <i>Designations</i>	Références <i>Part numbers</i>
<ul style="list-style-type: none"> Traversée de cloison à collerette carrée, broches, douilles Boîtiers 8 à 24 : arrangements 8.03 / 10.06 / 12.10 / 14.19 / 16.26 / 18.32 / 20.41 / 22.55 / 24.61 Positionnements : N & W Protections : 085 cadmiage vert / 112 oxydation anodique noire brillante <i>Square flange through bulkhead, pins, sockets</i> <i>Shell sizes 8 to 24 : layouts 8.03 / 10.06 / 12.10 / 14.19 / 16.26 / 18.32 / 20.41 / 22.55 / 24.61</i> <i>Insert rotations : N & W</i> <i>Plating : 085 green cadmium / 112 black anodized</i> 	EC 52 B
<ul style="list-style-type: none"> Raccord coudé à serre-câbles à encombrement réduit, pour fiche 08RC Boîtiers 12, 14, 16, 18 et 22 <i>Short profile 90° backshell with cable clamp for 08 RC plug</i> <i>Shell sizes 12, 14, 16, 18 and 22</i> 	SN 556
<ul style="list-style-type: none"> Connecteur fiche et embase Boîtier 24 équipé de 3 contacts # 16 - 7 contacts # 20 - 1 contact coaxial 50 Ω (pour câble KX 15) <i>Plug and receptacle connector</i> <i>Shell size 24 : contact layout = 3 contacts # 16, 7 contacts # 20, 1 coaxial contact 50 Ω (for KX15 cable)</i> 	SN 775 P SN 775 S
<ul style="list-style-type: none"> Fiche shunt <i>Shunt plug</i> 	SN 901
<ul style="list-style-type: none"> Raccord droit en deux parties avec presse-étoupe et brides de serrage Boîtiers 8, 10 et 16 <i>Straight two-piece backshell with sealing gland and cable strap</i> <i>Shell sizes 8, 10 and 16</i> 	SN 946
<ul style="list-style-type: none"> Fiche équipée d'une bague de verrouillage à oreilles Boîtiers 20, 22 et 24 <i>Plug with flanged coupling nut</i> <i>Shell sizes 20, 22 and 24</i> 	SN 1167
<ul style="list-style-type: none"> Prolongateur de test, broches, douilles Boîtiers 8 à 24, arrangements avec contacts de # 20 <i>Cable connecting test connector, pins, sockets</i> <i>Shell sizes 8 to 24, arrangements with size contacts # 20</i> 	SN 1206
<ul style="list-style-type: none"> Bague à oreilles avec vis pointeau adaptable sur fiche 851 Boîtiers 8 à 24 <i>Ring with lugs with cone-pointed grub screws fitting 851 plug</i> <i>Shell sizes 8 to 24</i> 	SN 1277
<ul style="list-style-type: none"> Raccord coudé fermé avec cheminée pour reprise de tresse par magnétostriction Boîtiers 8 à 24 <i>Elbow backshell with closing sleeve for shield termination by magnaforming</i> <i>Shell sizes 8 to 24</i> 	SN 1533
<ul style="list-style-type: none"> Embase type 07A à picots droits, démontage par l'avant Arrangements : 14.19 (N) / 16.26 (N) / 18.32 (N, X) / 20.41 (N, W, X, Y) / 22.55 (N, W, X, Y, Z) / 24.61 (N) Protection : cadmiage passivé vert <i>Jam nut receptacle with front release straight PC tails</i> <i>Layouts : 14.19 (N) / 16.26 (N) / 18.32 (N, X) / 20.41 (N, W, X, Y) / 22.55 (N, W, X, Y, Z) / 24.61 (N)</i> <i>Plating : passivated green cadmium</i> 	SN 0378

Autres arrangements, nous consulter / Other layouts, please consult us

851 Series - RJ45 Version



Présentation / Presentation

Le connecteur SOURIAU 851 RJ45 est une solution renforcée pour les applications de téléchargement / chargement de données en environnements sévères.

Disponible en taille 18, ce connecteur existe en divers types de boîtiers et avec différentes terminaisons: Fiche avec cordon RJ45, traversée de cloison ou à souder pour les embases à collerette carrée et à fixation par écrou.

Les principaux avantages de ce produit :

- Une solution Ethernet cat5e - 10 Base T, 100 Base TX, ou 1000 Base T
- Excellente résistance aux impacts & aux chocs - Boîtier renforcé
- Connexion facile, fiable & sécurisée
- Idéal pour les applications intérieures / extérieures - niveau d'étanchéité IP67

SOURIAU 851 RJ45 connector is a ruggedized solution for downloading / uploading data applications in harsh environments.

Available in shell size 18, this connector offers multiple configurations and terminations: Cable pig tail for plug, feed through and solder out for both square flange and jam nut receptacle.

Main advantages of this product :

- A cat5e Ethernet solution - 10 Base T, 100 Base TX, or 1000 Base T capable
- High impact & shock resistance - Ruggedized housing
- Easy, reliable & secure mating
- Suitable for Indoor / Outdoor applications - IP67 sealing level

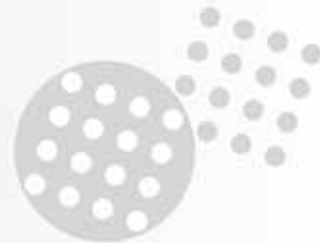

851 Series - RJ45 Version

Caractéristiques techniques / Technical characteristics

Mécaniques

Matières

- Boîtier Alliage d'aluminium
- Insert Thermoplastique
- Contacts Alliage cuivre

Protection

- Boîtier Cadmié vert olive
Oxydation anodique noire
Nickelé
- Contacts Or

Mécanique

- Selon MIL-DTL-26482, 500 manoeuvres

Mechanical

Material

- Shell Aluminium alloy

- Insert Thermoplastic
- Contacts Copper alloy

Plating

- Shell Olive drab cadmium
Black anodized
Nickel
- Contacts Gold

Mechanical

- per MIL-DTL-26482, 500 mating cycles

Electriques

10 BaseT, 100 Base TX et 1000 BaseT
Cat 5e selon TIA/EIA 568A/B

Electrical

10 BaseT, 100 Base TX and 1000 BaseT
Cat 5e per TIA/EIA 568A/B

Climatiques

- Etanchéité IP67 avec un bouchon
- Température -40°C à +85°C
- Résistance aux fluides :
selon MIL-DTL-26482 avec un bouchon

Climatic

- Sealing IP67 with protective cap
- Temperature -40°C to +85°C
- Fluid resistance :
per MIL-DTL-26482 with protective cap

Références / Ordering information

Racine / Basic series	851	00	00	8	J	C	S	N	OD	---
Ruggedized Receptacle connectors										
Type de boîtier / Shell type										
00	Embase à collerette carrée (acceptant un raccord) Square flange receptacle (accepting backshell)									
01	Prolongateur / Cable connecting receptacle									
07	Embase à fixation par écrou / Jam nut receptacle									
Type de raccord / Backshell type										
00	Pas de raccord / no backshell									
RC	Serre câbles droit / Straight cable clamp									
RT	Raccord droit pour gaine thermorétractable / Straight backshell for heat shrink tubing									
Taille de boîtier / Shell size										
8	RJ45 (size 18)									
Insert / Insert										
J	RJ45									
Arrangements / Layouts										
F	Traversée de cloison / Feedthrough									
S	A souder / Solder									
C	Embase avec cordon RJ45 / Pig tail receptacle									
P	Fiche avec cordon RJ45 / Pig tail plug									
Style de contact / Contact style										
S	Embase / Receptacle									
P	Fiche / Plug									
Orientation / Polarization										
N	Normal									
W, X, Y, Z	Autre orientations / Other polarizations									
Protection / Plating										
OD	Protection vert olive cadmiée / Olive drab cadmium									
031	Oxydation anodique noire / Black anodized									
44	Nickelé / Nicke									
Spécification / Specification										
Nous consulter pour une configuration personnalisée / Consult factory for custom configuration										

851 Series - RJ45 Version



Encombrements / Dimensions

Embase RJ45 à collerette carrée Square flange RJ45 feedthrough

Shell type	'A'	'B'
Aluminium	30.91	1.32

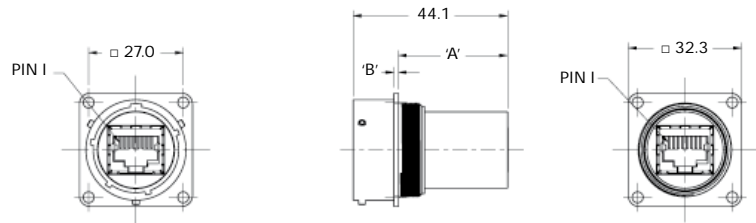

Embase RJ45 à fixation par écrou Jam nut RJ45 feedthrough

Shell type	'A'	'B'
Aluminium	23.39	2.64

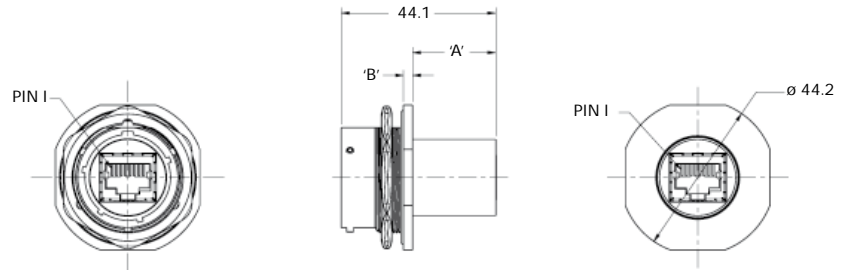

Embase RJ45 à collerette carrée à souder Square flange RJ45 feedthrough solder out

Shell type	'A'	'B'
Aluminium	22.98	1.32

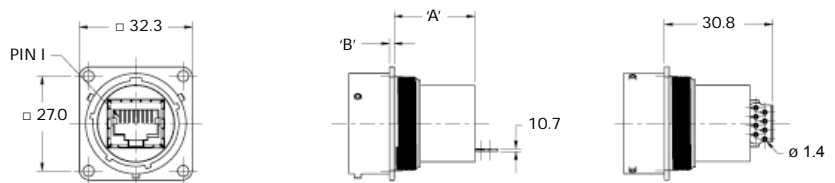

Note : toutes les dimensions sont en mm / all dimensions are in mm



851 Series - RJ45 Version

Embase RJ45 à fixation par écrou à souder Jam nut RJ45 feedthrough solder out

Shell type	'A'	'B'
Aluminium	15.27	2.64



Embase à collerette carrée avec cordon RJ45 Square flange RJ45 feedthrough Pig tail

Shell type	'A'	'B'	'C'
Aluminium	30.91	1.32	304.8 ^{+25.4}



Livrée en standard avec un câble de dimension 'C'
Come with a cable - dimension 'C' - in standard.

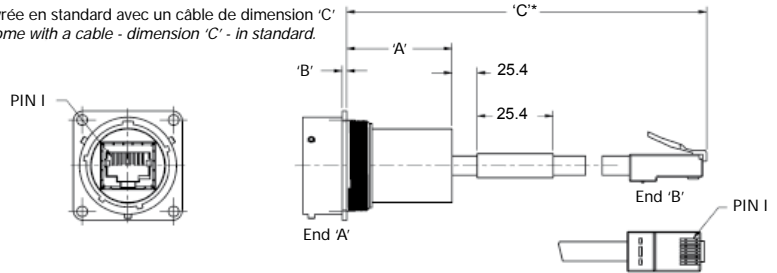

Embase à fixation par écrou avec cordon RJ45 Jam nut RJ45 feedthrough Pig tail

Shell type	'A'	'B'	'C'
Aluminium	23.39	2.64	304.8 ^{+25.4}



Livrée en standard avec un câble de dimension 'C'
Come with a cable - dimension 'C' - in standard.



Perçage de cloison / Panel cut-out

Embase à collerette carrée / Square flange receptacle



Epaisseur maximum du panneau : 0.41 mm min / 3.18 mm max
Maximum panel thickness : 0.41 mm min / 3.18 mm max

Embase à fixation par écrou / Jam nut receptacle



Epaisseur maximum du panneau : 4.75 mm
Maximum panel thickness : 4.75 mm

Note : toutes les dimensions sont en mm / all dimensions are in mm

* Longueur du câble mesurée à partir de l'avant de la collerette / Cable length is measured from the front face of the flange.



851 Series - USB Version



Présentation / Presentation

Le connecteur SOURIAU 851 USB est une solution renforcée pour les applications de téléchargement / chargement de données en environnements sévères.

Disponible en taille 16, ce connecteur existe en divers types de boîtiers et avec différentes terminaisons: Fiche avec cordon USB, traversée de cloison ou à souder pour les embases à collerette carrée et à fixation par écrou.

Les principaux avantages de ce produit :

- Excellente résistance aux impacts & aux chocs - Boîtier renforcé
- Connexion facile, fiable & sécurisée
- Idéal pour les applications intérieures / extérieures - niveau d'étanchéité IP67

SOURIAU 851 USB connector is a ruggedized solution for downloading / uploading data applications in harsh environments.

Available in shell size 16, this connector offers multiple configurations and terminations: Cable pig tail for plug, feed through and solder out for both square flange and jam nut receptacle.

Main advantages of this product :

- *High impact & shock resistance - Ruggedized housing*
- *Easy, reliable & secure mating*
- *Suitable for Indoor / Outdoor applications - IP67 sealing level*



851 Series - USB Version

Caractéristiques techniques / Technical characteristics

Mécaniques

Matières

- Boîtier Alliage d'aluminium
- Insert Thermoplastique
- Contacts Alliage cuivre

Protection

- Boîtier Cadmié vert olive
Oxydation anodique noire
Nickelé
- Contacts Or

Mécanique

- Selon MIL-C-26484, 500 manoeuvres

Mechanical

Material

- Shell Aluminium alloy

- Insert Thermoplastic
- Contacts Copper alloy

Plating

- Shell Olive drab cadmium
Black anodized
Nickel
- Contacts Gold

Mechanical

- per MIL-C-26484, 500 mating cycles

Electriques

10 BaseT, 100 Base TX
Cat 5e selon TIA/EIA 568A/B

Electrical

10 BaseT, 100 Base TX
Cat 5e per TIA/EIA 568A/B

Climatiques

- Etanchéité IP67 avec bouchon
- Température de -40°C à +85°C
- Résistance aux fluides : selon MIL-C-26484 avec bouchon

Climatic

- Sealing IP67 with protective cap
- Temperature range : -40°C to +85°C
- Fluid resistance : per MIL-C-26484 with protective cap

Références / Ordering information

Racine / Basic series	851	00	00	6	A	C	S	N	OD	---
Ruggedized Receptacle connectors										
Type de boîtier / Shell type										
00	Embase à collerette carrée (acceptant un raccord) <i>Square flange receptacle (accepting backshell)</i>									
01	Prolongateur / Cable connecting receptacle									
07	Embase à fixation par écrou / Jam nut receptacle									
06	Fiche (acceptant un raccord) / Plug (accepting backshell)									
Type de raccord / Backshell type										
00	Pas de raccord / no backshell									
RC	Serre câbles droit / Straight cable clamp									
RT	Raccord droit pour gaine thermorétractable / Straight backshell for heat shrink tubing									
Taille de boîtier / Shell size										
6	USB (size 16)									
Insert / Insert										
A	USB Type A									
B	USB Type B									
Arrangements / Layouts										
F	Traversée de cloison / Feedthrough									
S	A souder / Solder									
C	Embase avec cordon USB / Pig tail receptacle									
P	Fiche avec cordon USB / Pig tail plug									
Style de contact / Contacts style										
S	Embase / Receptacle									
P	Fiche / Plug									
Orientation / Polarization										
N	Normal									
W, X, Y, Z	autres orientations / other polarizations									
Protection / Plating										
OD	Protection vert olive cadmiée / Olive drab cadmium									
031	Oxydation anodique noire / Black anodized									
44	Nickelé / Nickel									
Spécification / Specification										
Nous consulter pour une configuration personnalisée / Consult factory for custom configuration										



851 Series - USB Version

Encombrements / Dimensions

Fiche avec cordon USB USB cable plug

Shell type	'A'
Aluminium	304.8

La fiche USB standard est livrée avec un câble de dimension 'A'.
Standard USB plug come with a cable - dimension 'A'.

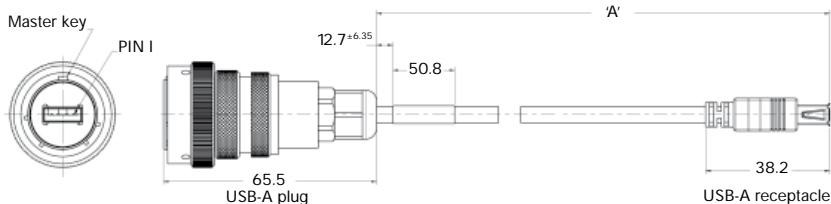

Embase USB à collerette carrée Square flange USB feedthrough

Shell type	'A'	'B'
Aluminium	24.82	1.32



Embase USB à fixation par écrou Jam nut USB feedthrough

Shell type	'A'	'B'
Aluminium	17.30	2.64



Embase USB à collerette carrée à souder Square flange USB feedthrough solder out

Shell type	'A'	'B'
Aluminium	15.16	1.32



Note : toutes les dimensions sont en mm / all dimensions are in mm



851 Series - USB Version

Embase USB à fixation par écrou à souder Jam nut USB feedthrough solder out

Shell type	'A'	'B'
Aluminium	7.65	2.64

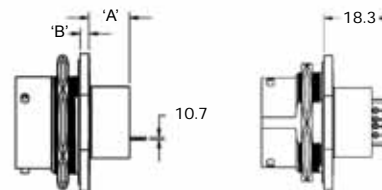

Embase à collerette carrée avec cordon USB Square flange USB feedthrough Pig tail

Shell type	'A'	'B'	'C'
Aluminium	24.82	1.32	304.8 ^{+25.4}

Livrée en standard avec un câble de dimension 'C'
Come with a cable - dimension 'C' - in standard.

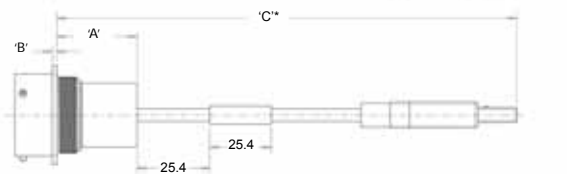
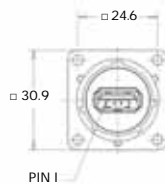

Embase à fixation par écrou avec cordon USB Jam nut USB feedthrough Pig tail

Shell type	'A'	'B'	'C'
Aluminium	17.30	2.64	304.8 ^{+25.4}

Livrée en standard avec un câble de dimension 'C'
Come with a cable - dimension 'C' - in standard.

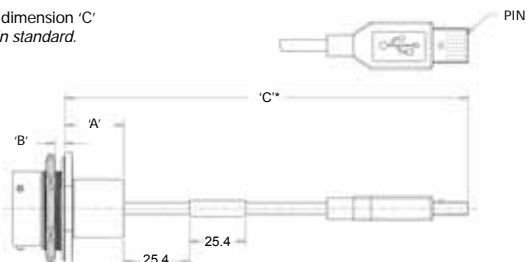
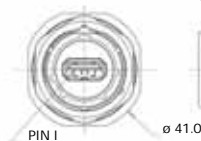

Perçage de cloison / Panel cut-out

Embase à collerette carrée / Square flange receptacle

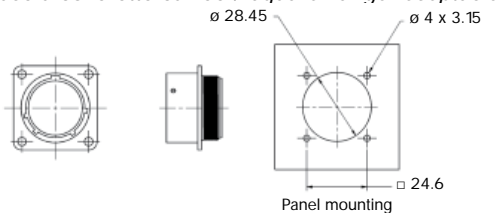

Epaisseur maximum du panneau / Maximum panel thickness :
- Montage par l'avant / Front mounting: 3.20 mm
- Montage par l'arrière / Rear mounting: 2.49 mm

Embase à fixation par écrou / Jam nut receptacle

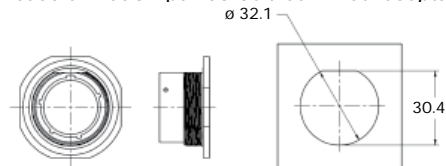

Epaisseur maximum du panneau : 3.20 mm
Maximum panel thickness : 2.49 mm

Note : toutes les dimensions sont en mm / all dimensions are in mm

* Longueur du câble mesurée à partir de l'avant de la collerette / Cable length is measured from the front face of the flange.



Présentation / Presentation

Le connecteur 851 surmoulé SOURIAU est en **plastique, chargé verre, haute performance** offrant une excellente résistance aux impacts & chocs ainsi qu'une **forme ergonomique** de la bague de verrouillage.

Le raccord, utilisant la même matière plastique permet d'obtenir un **niveau d'étanchéité IP68**.

- Excellente résistance aux impacts & aux chocs (aux chutes & à l'écrasement)
- Connexion facile, fiable & sécurisée
- Excellentes performances d'étanchéité IP68 (120 heures sous 15 m d'eau) / IP69K
- Excellente résistance au brouillard salin
- Excellente étanchéité sur le câble
- Intermariable & interchangeable avec les connecteurs MIL-DTL-26482
- Flexibilité de configuration

*SOURIAU overmolded 851 connector utilises **high impact glass filled plastic** offering a great impact & shock resistance as well as an **ergonomic shape** of the coupling ring.*

*Suitable backshell in same plastic material allows **IP68 sealing level**.*

- *High impact & shock resistance (drop & crush resistance)*
- *Easy, reliable & secure mating*
- *Excellent sealing performance : IP68 (120 hours under 15 m water) /IP69K*
- *High salt spray resistance*
- *Enhanced cable sealing*
- *Intermateable & interchangeable with MIL-DTL-26482*
- *Design flexibility*



Caractéristiques techniques / Technical characteristics

Mécaniques

- Endurance 500 manoeuvres min.
- Boîtier Alliage d'aluminium - anodisé dur
- Insert Elastomer néoprène
- Contacts Alliage de cuivre - protection or
- Enveloppe extérieure
Plastique chargé verre haute résistance
- Joint bague de verrouillage
Teflon sur silicone

Mechanical

- Durability 500 mating min.
- Shell Aluminium alloy - hard anodized
- Insert Neoprene elastomer
- Contacts Copper alloy with gold plating
- Housing High impact glass filled plastic
- Coupling ring seal Teflon over silicone

Electriques

- Résistance d'isolement 5000 M Ω
- Tension de tenue 2300 V
- Résistance contact 3 M Ω
- Intensité admissible par contact
Taille 16 : 13 A / Taille 20 : 7.5 A

Electrical

- Insulation resistance 5000 M Ω
- Dielectric withstanding voltage 2300 V
- Contact resistance 3 M Ω
- Current rating per contact
Size 16: 13 A / Size 20: 7.5 A

Climatiques

- Température d'utilisation -55°C à +125°C
- Etanchéité Interface IP68 (jusqu'à 120 heures sous 15 mètres d'eau)
- Résistance aux produits chimiques selon MIL-DTL-26482 Série 1

Climatic

- Working temperature -55°C to +125°C
- Sealing Interfacial IP68 (up to 120 hours under 15 meters of water)
- Resistance to chemicals in accordance with MIL-DTL-26482 Series 1

Acceptance câbles

- Câble Gauge 14 max.
- Diamètre gaine extérieure: Toutes tailles jusqu'à 11.17 mm

Cable acceptance

- Primaries wire Gauge 14 max.
- Outer jacket all popular sizes up to 11.17 mm

Références / Ordering information

Racine / Basic series	8XE	06	-	16	8	P	-	BL	V8	---
Connecteur pour environnement EXTREME connector for EXTREME environment										
Type de boîtier / Connector type										
01 Prolongateur / Cable connecting receptacle										
06 Fiche / Plug										
Type de contact / Contact type										
Pas de digit / No digit à souder / to solder										
R à sertir / to crimp										
Taille de boîtier / Shell size										
10, 12, 14, 16, 20, 22										
Arrangements / Layouts										
Voir page suivante / See next page										
Sexe du contact / Contact gender										
P Mâle / male										
S Femelle / female										
Orientations / Insert orientations										
Pas de digit / No digit Normal (n'apparaît pas dans la référence) / Standard (not included in part number)										
W, X, Y, Z autres orientations / other orientations										
Couleur / Color										
Pas de digit / No digit Gris / Mink (standard)										
BL Bleu / Blue YE Jaune / Yellow RE Rouge / Red										
Autres couleurs disponibles / Others available										
Specification / Design variation										
V7 Boîtier renforcé en taille 16 & 20 (pour prolongateur) / ruggedized shells in size 16 & 20 (for cable connecting receptacle)										
V8 Boîtier renforcé en taille 16 & 20 (pour fiche) / ruggedized shells in size 16 & 20 (for plug)										
AA Boîtier inox renforcé en taille 16 & 20 (Ø câble 8 mm) / ruggedized stainless steel shells in size 16 & 20 (cable Ø 8 mm)										
Diamètre du câble / Cable diameter										
Personnalisation possible / Custom available										



Arrangements / Contact layouts

Vue de face avant isolant mâle / Viewed from front face of male insulator

10

6	7	98
6 Ø 1 (#20)	7 Ø 1 (#20)	6 Ø 1 (#20)

12

2	3	8	10	14
2 Ø 1.6 (#16)	3 Ø 1.6 (#16)	8 Ø 1 (#20)	10 Ø 1 (#20)	14 Ø 1 (#20)

14

5	12	15	18	19
5 Ø 1.6 (#16)	8 Ø 1 (#20) 4 Ø 1.6 (#16)	14 Ø 1 (#20) 1 Ø 1.6 (#16)	18 Ø 1 (#20)	19 Ø 1 (#20)

16

8	23	26
8 Ø 1.6 (#16)	22 Ø 1 (#20) 1 Ø 1.6 (#16)	26 Ø 1 (#20)

20

16	24	25	27	39	41
16 Ø 1.6 (#16)	24 Ø 1 (#20)	25 Ø 1 (#20)	27 Ø 1 (#20)	37 Ø 1 (#20) 2 Ø 1.6 (#1.6)	41 Ø 1 (#20)

22

21	32	34	36	55
21 Ø 1.6 (#16)	32 Ø 1 (#20)	34 Ø 1 (#20)	36 Ø 1 (#20)	55 Ø 1 (#20)

8XE Series



Orientations

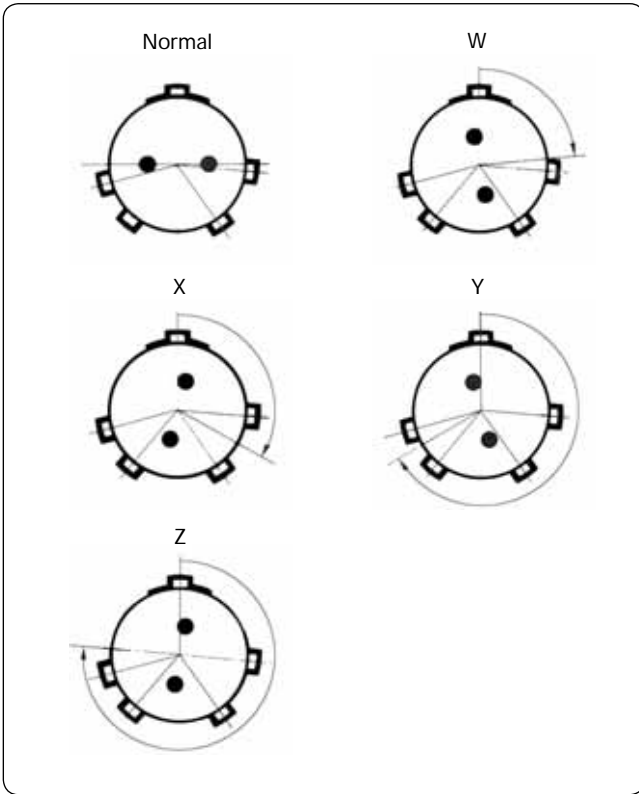

Viewed from front face of male insulator (receptacle or plug)

Shell sizes	Layouts	Angle in degrees			
		W	X	Y	Z
10	6	90	-	-	-
	7*	90	-	-	-
	98	90	180	240	270
12	3	-	-	180	-
	8	90	112	203	292
	10	60	155	270	295
	2	-	-	-	-
14	14*	45			
	5	40	92	184	273
	12	43	90	-	-
	15	17	110	155	234
	18	15	90	180	270
16	19	30	165	315	-
	8	54	152	180	331
	23	158	270	-	-
20	26	60	-	275	338
	16	238	318	333	347
	39	63	144	252	333
	41	45	126	225	-
	24	70	145	215	290
	25	72	144	216	288
22	27	72	144	216	288
	21	16	135	175	349
	36	72	144	216	288
	55	30	142	226	314
	32	72	145	215	288
	34	62	142	218	298

* 10-7 & 12-14 layouts, W non standard orientation

Encombremments / Dimensions

Fiche / Plug



Shell sizes	Ø A	B	C
10	24.9	51.2	104.5
12	27.9	51.2	103.7
14	33.0	57.6	110.8
16	36.2	63.9	122.2
20	43.7	108.4	197.1
22	48.8	91.4	184.1
16 specif.V8	41.9	83.4	172
20 specif.V8	47	91.4	184.2

Note : toutes les dimensions sont en mm / all dimensions are in mm



851 Series

Protection non cadmiée

SOURIAU propose des connecteurs 851 avec une protection noire non cadmiée. Cette protection zinc-nickel a été développée pour répondre aux nouvelles exigences en matière de respect de l'environnement (directive Européenne 76/769 EEC).

Raison :

- Réduire le niveau de pollution par métaux lourds produit par le cadmium
- Réduire les risques de santé engendrés par les produits cadmiés.

Caractéristiques :

- Mécaniques
 - boîtiers : aluminium
 - protection : zinc-nickel
- Electriques (1)
 - continuité électrique des boîtiers : $\leq 5 \text{ m}\Omega$
- Climatiques
 - tenue au brouillard salin : 500 heures

Références :

Exemples* :

- Version à souder
851 00 E 8-3A P.54 protection zinc-nickel
- Version à sertir
851 00 R 8-3A P.54 protection zinc-nickel

* Voir système de référence

- page 11 (version à souder et à sertir)
- page 13 (version à picots et connexions enroulées)

Cette protection est disponible pour les boîtiers de type :

- **00**: embase à collerette carrée avec possibilité de raccord
- **02**: embase à collerette carrée sans possibilité de raccord
- **07**: embase à fixation par écrou avec possibilité de raccord
- **07A**: embase à fixation par écrou sans possibilité de raccord
- **01**: prolongateur
- **06**: fiche droite sans bague de blindage
- **36**: fiche droite avec bague de blindage

Raccords, nous consulter.

Cadmium free plating

SOURIAU propose a 851 connector with cadmium free plating black. This zinc-nickel plating has been introduced in accordance with European Health and Safety requirements (European directive 76/769 EEC).

Reason:

- Reduction in level of heavy metal pollutants produced by cadmium.
- Reduction in health associated with the corrosive by products of cadmium.

Characteristics :

- Mechanical
 - shell: aluminium alloy
 - plating : zinc-nickel
- Electrical (1)
 - shell continuity: $\leq 5 \text{ m}\Omega$
- Climatic
 - salt spray: 500 hours

Part numbers:

Examples* :

- Solder version
851 00 E 8-3A P.54 zinc-nickel plating
- Crimp version
851 00 R 8-3A P.54 zinc-nickel plating

* See part numbers system

- page 11 (solder and crimp version)
- page 13 (straight PC tails and wire-wrap versions)

This plating is available for shell type :

- **00**: square flange receptacle accepting backshells
- **02**: square flange receptacle not accepting backshells
- **07**: jam nut receptacle accepting backshells
- **07A**: jam nut receptacle not accepting backshells
- **01**: cable connecting receptacle
- **06**: plug for use without straight backshell
- **36**: screened plug for use with straight backshells

Backshells, please consult us.

1 : Embase accouplée sur fiche type 36 - Receptacle mated on type 36 plug



www.souriau.com
www.souriau-industrial.com
contactindustry@souriau.com

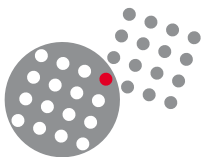

SOURIAU