

JBX  
Push Pull

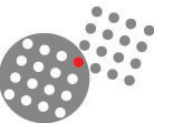

## JBX Push Pull

High reliability where quick, simple coupling mechanism is required

- |                                |   |   |
|--------------------------------|---|---|
| Secure, quick confirmed mating | ✓ | Tactile, Audible, Visual  |
| Blind mate capability          | ✓ | Mechanically keyed - prevents accidental engagement of wrong connector  |
| A versatile product            | ✓ | * Ergonomic design, fast and easy to use<br>* Modular design<br>* 5 shell sizes<br>* Solder, crimp, PCB, R/A PCB contact terminations |
| Space Saving                   | ✓ | * Small footprint, allows access in tight applications<br>* High density layouts 2 - 30 pins  |
| Economical                     | ✓ | Multiple cable collets / single part number   |
| Rugged                         | ✓ | Metal shielding housing, high vibration and shock environments  |

[www.souriau.com](http://www.souriau.com)

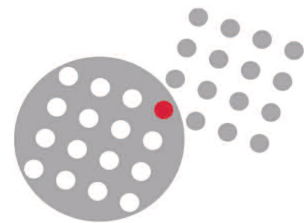

**SOURIAU**  
Connection Technology

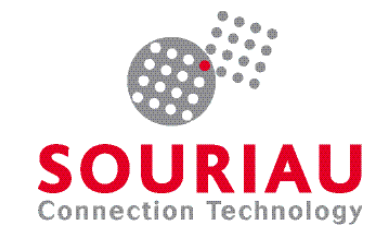

# Push Pull Connectors



# Push Pull Connectors



## Part number system

Basic series	JBX	FD	1	G	05	M	C	S	D	S	M	R
Shell type-Receptacle	ER-EA-SR-PC-ED-EP-EZ-SA											
Shell type - Plug	FD-FC-FF-FM-FN											
Shell size	00 - 0 - 1 - 2 - 3											
Keying	G - J - A - B											
Contact layout	02 ----- 30											
Contact type	M : pin F : socket											
Contact termination	C: crimp; S: solder; P*: straight PCB tails ; Q*: Right Angle PCB tails											
Surface plating	S : Outer shell brass alloy chrome over nickel plating N : Outer shell in brass alloy with black plating (consult Souriau USA)											
Obligatory Suffix	D : For all part numbers											
Contact Size	S : All contact diameters except .05 mm P : 0.5 mm contact dimensions only											
Cable Backnut Option	M : Connector with backnut for protective boot - Protective boot to order separately page 13											
Key Identifier	R : Red dot on shell for ED, ER, EZ, PC, SR, FC, FD, FF, FM & FN only											

\* For receptacles with female contacts only.

## Shell Types

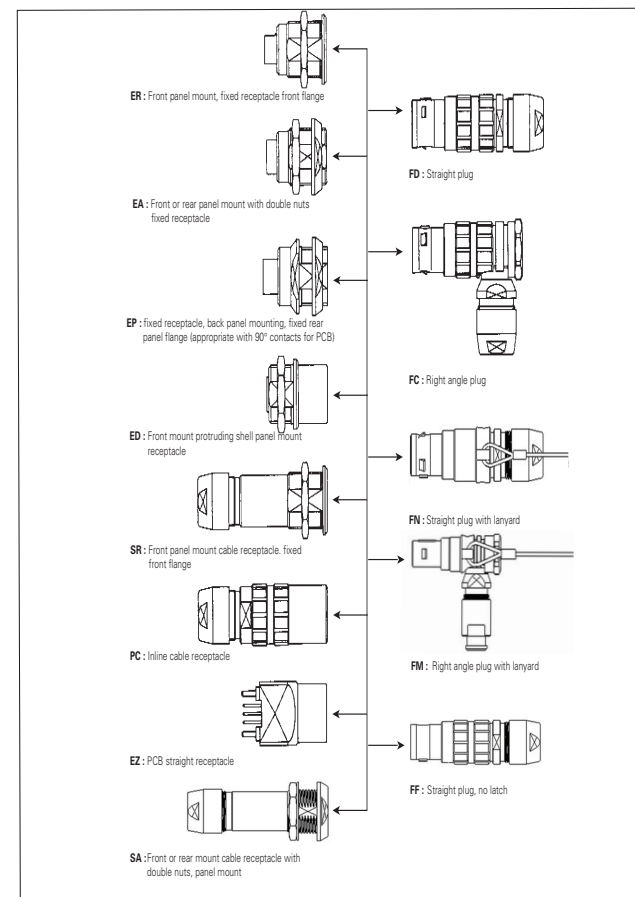

## Technical characteristics

### Environmental

- \* IP40 & IP 67/68
- \* Temperature range: IP40 -40° - +125°C
- \* Temperature range: IP67/68 -40° - +80°C
- \* Shielding effectivity: 55dB up to 100MHz

### Mechanical

- \* Shell: Brass alloy
- \* Shell plating: Chrome over nickel
- \* Insulator: Peek
- \* Contact: Brass
- \* Contact plating: Gold
- \* Up to 8 key options
- \* 7 Color code options
- \* 5 Shell sizes
- \* >1,000 Mating cycles

### Electrical

- \* Contact termination: Solder, Crimp PCB, R/A PCB
- \* Contact rating:
 

0.5mm	2.0-2.5 Amp
0.7mm	5.0-7.0 Amp
0.9mm	7.0-10.0 Amp
1.3mm	11.0-15.0 Amp
1.6mm	15.0-17.0 Amp
2.0mm	25.0-30.0 Amp

## Contacts layouts

Shell size 2							
	02	03	04	05	06	07	08
Male Insulator Wire Side							
Solder	S	S	S	S	S	S	S
Crimp	C	C	C	C	C	C	C
PCB Straight Tails*	XX	XX	P	P	P	P	P
PCB Right Angle*			Q	Q	Q	Q	Q
Contact Diameter mm	1.3	1.3	1.3	1.3	1.3	1.3	0.9

Shell size 2					
	10	12	16	18	19
Male Insulator Wire Side					
Solder	S	S**	S**	S**	S**
Crimp	C	C	C	C	C
PCB Straight Tails*	P	P	P	P	P
PCB Right Angle*	Q	Q	Q		
Contact Diameter mm	0.9	0.7	0.7	0.7	0.7

Shell size 3									
	03	04	07	08	10	14	18	22	30
Male Insulator Wire Side									
Solder	S**	S**	S	S	S	S	S	S**	S**
Crimp	C	C	C	C	C	C	C	C	C
PCB Straight Tails*	XX	XX	XX	P	P	P	P	P	P
PCB Right Angle*									
Contact Diameter mm	2	2	1.6	1.3	1.3	0.9	0.9	0.7	0.7

Please contact Souriau for additional technical information

# Push Pull Connectors



## Contacts layouts

Shell size 00	
Male Insulator Wire Side	<b>04</b> 
Solder	S
Crimp	
PCB Straight Tails	
PCB Right Angle*	
Contact Diameter mm	0.5

Shell size 0							
Male Insulator Wire Side	<b>02</b> 	<b>03</b> 	<b>04</b> 	<b>05</b> 	<b>06</b> 	<b>07</b> 	<b>08</b> 
Solder	S	S	S**	S**	S**	S**	S**
Crimp	C	C	C	C	C	C	C
PCB Straight Tails*	P	P	P	P	P	P	P
PCB Right Angle*	Q	Q	Q	Q	Q	Q	Q
Contact Diameter mm	0.9	0.9	0.7	0.7	0.5	0.5	0.5

Shell size 1									
Male Insulator Wire Side	<b>02</b> 	<b>03</b> 	<b>04</b> 	<b>05</b> 	<b>06</b> 	<b>07</b> 	<b>08</b> 	<b>10</b> 	<b>12</b> 
Solder	S	S	S	S	S**	S**	S**	S**	S**
Crimp	C	C	C	C	C	C	C	C	C
PCB Straight Tails*	P	P	P	P	P	P	P	P	P
PCB Right Angle*		Q	Q	Q	Q	Q	Q		
Contact Diameter mm	1.3	1.3	0.9	0.9	0.7	0.7	0.7	0.5	0.5

### • Voltage Test Procedure

- **The testing voltage** corresponds to the maximum voltage the connector is able to withstand in normal climatic conditions. The value is about 75% of the electrical breakdown voltage. The testing voltage level can be reached several times in connectors life, but never applied for a continuous duration.

- **The working voltage** corresponds to the maximum voltage the connector is able to withstand continuously during its life time, in real environmental conditions, even with high temperature. The value is around 1/3 of the testing voltage.

### • Maximum current rating

- **This indicated maximum current rating** corresponds to the maximum current that can be applied **simultaneously on each line of the connector mated pair**, continuously during its life time, in normal climatic conditions.

Remark : If the current is applied on only one contact of the layout, then an increased current value can be achieved over a long duration.

\*\*Inserts with fixed non removable contacts

\* For receptacles with female contacts.

**Note** : Contact numbering mating faces receptacle view: counterclockwise from key at position 1  
Contact numbering mating faces plug view: clockwise from key at position 1

# Push Pull Connectors



KEYING	G	Dual Key Way			
		J		A	B*
		sizes 0 - 1	sizes 2 - 3		
Keying angle	0°	45°	37.5°	30°	60°
Plug					
Receptacle					

## Options

### • Protective boot

With each JBX connector, one protective boot can accept diverse cable diameters thus the end-user can manage various cable diameters without bothering with multiple part numbers.

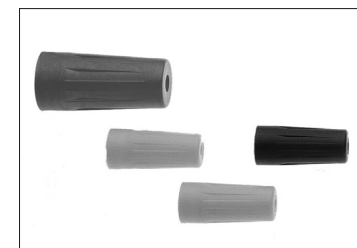
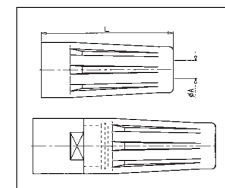

• **Caps** : an efficient protection against dust

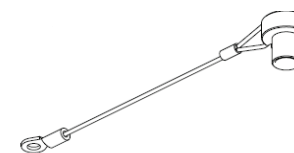

Part number	Shell size	Dimensions			
		Ø A	L	Ø Cable	
				min	max
JBX 00 MPN	00	1.5	15	1	3.5
JBX 0 MP*	0	2.2	20	1.5	5.5
JBX 1 MP*	1	2.6	25	2	7.5
JBX 2 MP*	2	4	30	3.5	9.7
JBX 3 MP*	3	5	35	4.9	12

\* Color code - See chart below / In size 00, available only in black

Color code	Colors
A	blue
B	white
G	grey
J	yellow
M	brown
N	black
R	red
V	green
O	orange

**Material** : ELASTOLLAN (PUR)

**Working temperature** :

- 40°C ; + 80°C

- 40°F ; + 176°F

Parts that require a protective boot need to be ordered with an M suffix. **Protective boots are ordered separately.**

Receptacle Caps		Plug Caps	
Part number	Shell Size	Part number	Shell Size
		<b>JBX BF00</b>	00
<b>JBX BR0</b>	0	<b>JBX BF0</b>	0
<b>JBX BR1</b>	1	<b>JBX BF1</b>	1
<b>JBX BR2</b>	2	<b>JBX BF2</b>	2
<b>JBX BR3</b>	3	<b>JBX BF3</b>	3

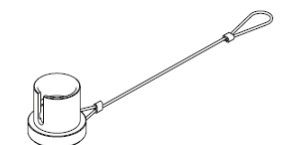

# Push Pull Connectors



## Dimensions - Receptacles

ER : Front mount

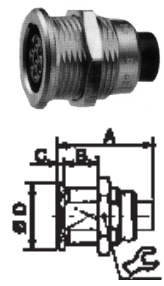

Size	00	0	1	2	3
A	14	19	21	24	28
B	6	8	10	10	12
C	0.8	1.2	1.5	1.8	2.0
Ø D	8	10	14	18	22

EA : Double nut

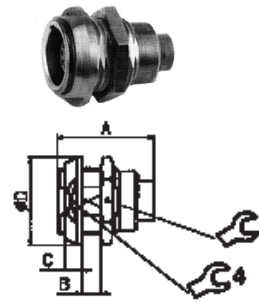

Size	0	1	2	3
A	19	21	24	28
B	6.7	8.3	8	9.5
C	2.5	3.2	3.8	4.5
Ø D	12	16	20	24

EP : Rear mount

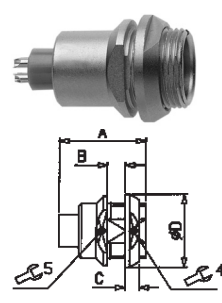

Size	0	1	2
A	19	21	24
B	4.5	6	6.5
C	2.5	3.2	3.8
Ø D	12	16	20

SA : Double nut panel mount receptacle

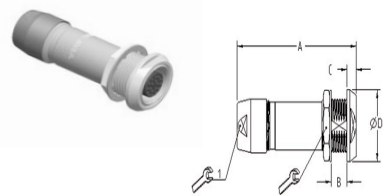

Size	0	1	2	3
A	38	43	50	59
B	-	-	6.5	-
C	2.5	3.2	3.8	-
Ø D	12	16	20	24

ED : Front mount, protruding

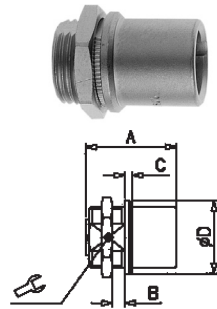

Size	0	1	2
A	19	21	24
B	3	4.5	6.3
C	1.2	1.5	1.8
Ø D	10	14	18

SR : Front mount cable clamp

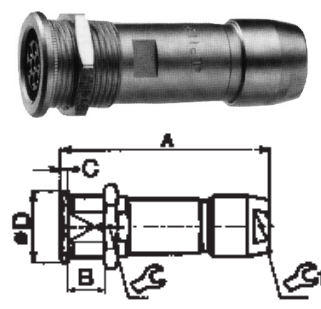

Size	0	1	2	3
A	38	43	50	59
B	8	10	10	12
C	1.2	1.5	1.8	2
Ø D	10	14	18	22

PC : In line receptacle

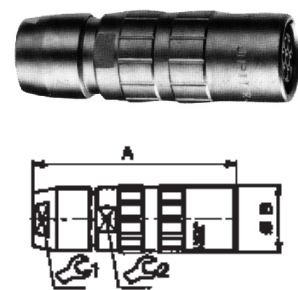

Size	0	1	2	3
A	38	43	50	59
Ø B	10	13	16	19.5

EZ : PCB

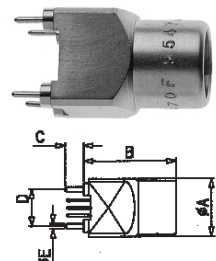

Size	0	1
Ø A	10	12
B	19	21
C	4	4
D	7.62	7.62
Ø E	1.1	1.1

# Push Pull Connectors



## Dimensions - Plugs

FC : Straight Plug with Lanyard

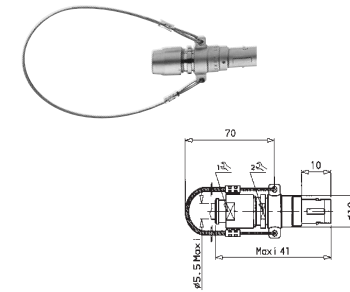

Size	0	1	2	3
A	30.5	36.5	42.5	50.5
B	20.5	25.5	30.5	35.5
C	29.5	33.5	36.5	45
Ø D	10	12	15	18

FM : Right angle with lanyard

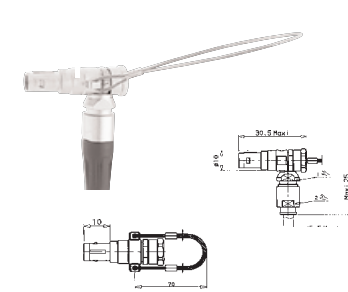

Size	0	1	2	3
A	30.5	36.5	42.5	50.5
B	20.5	25.5	30.5	35.5
C	29.5	33.5	36.5	45
Ø D	10	12	15	18

FF : Straight, no latch

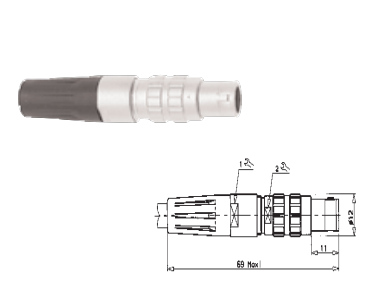

Size	0	1	2	3
A	30.5	36.5	42.5	50.5
B	20.5	25.5	30.5	35.5
C	29.5	33.5	36.5	45
Ø D	10	12	15	18

FN : Straight plug with lanyard

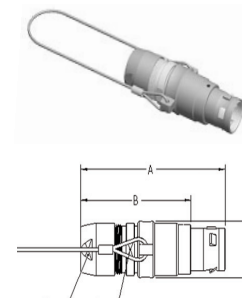

Size	00	0	1	2	3
A	31	39	45	52	62
B	23	29	34	40	47
Ø C	8	1	13	16	19

FC : Right angle

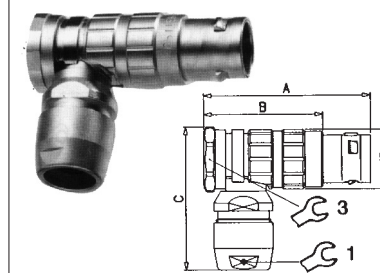

Size	0	1	2	3
A	30.5	36.5	42.5	50.5
B	20.5	25.5	30.5	35.5
C	29.5	33.5	36.5	45
Ø D	10	12	15	18

FD : Straight

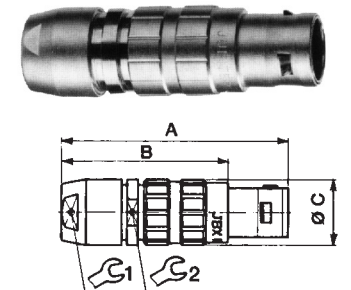

Size	00	0	1	2	3
A	31	39	45	52	62
B	23	29	34	40	47
Ø C	7	10	12	15	18

## Range of cable diameters

With the plastic collet set supplied with the standard product, a wide range of cable diameters is allowed. Find below the maximum and the minimum for each size of shell (for information only because it can change with the cable characteristics).

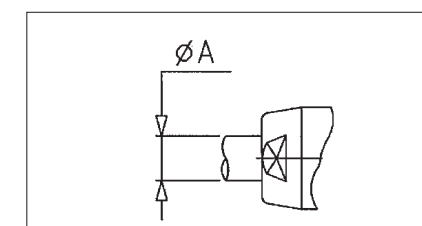

Size	00	0	1	2	3
Ø A min	1.1	1.5	2.0	3.5	4.9
Ø A Max	3.5	5.5	7.5	9.7	12.0