

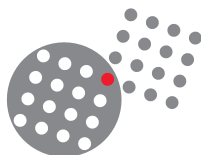

# D-Subminiature Series

## Rectangular Connectors



**SOURIAU**





# D-Subminiature Series



## Presentation

- Souriau D-Sub connectors are used for military/aerospace applications and in industrial field: information systems, communication systems, industrial electronic...
- D-Sub connectors are designed to ensure the connection function in all applications where weight and dimension are very important.
- They are especially used as Input/Output connectors in interface fonctions. So, they are subjects to mechanical constraints that are sometimes severes.
- In order to prevent risks (pulling up, accidental unmating...), a large range of accessories is supplied.

## Contents

### Overview

- D-Sub Mark III standard ranges ..... 06
- Technical characteristics ..... 07
- Layouts ..... 08
- PCB drilling dimensions ..... 09

### Series

- 8630 Series HE501 ..... 12
- 8630 Series HE508 ..... 14
- SMA MIL-C Series ..... 16
- 8635 Series ..... 19
- D-Sub hermetic connectors ..... 21

### Common Section

- Panel mounting ..... 26
- Shell dimensions ..... 27
- Mounting options ..... 28

# D-Sub Series



## D-Subminiature Series

# Overview

■ D-Sub Mark III standard ranges .....	06
■ Technical characteristics .....	07
■ Layouts .....	08
■ PCB drilling dimensions .....	09



# D-Subminiature Series



## D-Sub Mark III standard ranges

### 8630 Series HE 501

See page 12

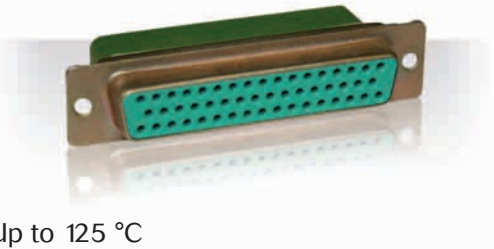

- ▶ Up to 125 °C
- ▶ Crimped contact #20

### 8630 Series HE 508

See page 14

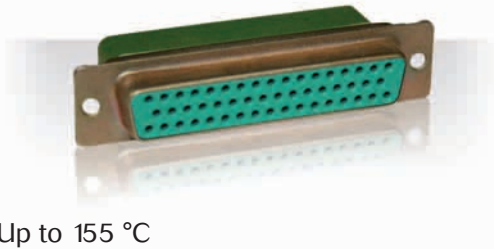

- ▶ Up to 155 °C
- ▶ Crimped contact #20

### SMA MIL-C Series

See page 16

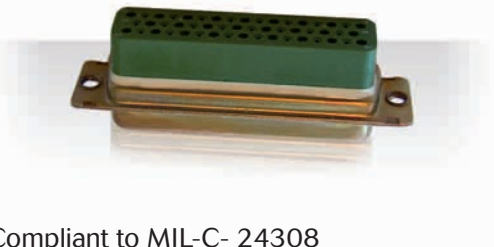

- ▶ Compliant to MIL-C- 24308
- ▶ Crimped contact #20

### 8635 Series

See page 19



- ▶ High Density
- ▶ Individual glass bead
- ▶ Straight spills & Crimped contact #22

### Hermetic Series

See page 21



- ▶ Solder buckets and eyelets
- ▶ Straight spills & Crimped contact #20
- ▶ Hermeticity level:  $10^{-7}$  atm.cm<sup>3</sup>/s
- ▶ Individual glass bead

# D-Subminiature Series



## Technical characteristics

Characteristics		Series	8630 HE501	8630 HE508	SMA MIL	8635 High Density	Hermetic
		Crimp version	Crimp version	Crimp version	Crimp or PCB version	Solder or PCB version	
Environmental	Temperature	-55°C to +125°C	-55°C to +155°C	-55°C to +125°C	-55°C to +155°C	-55°C to +125°C	
	Salt spray	48h (cadmium) 24h (tin & zinc)	48h (cadmium) 24h (tin & zinc)	48h (cadmium)	48h (cadmium) 24h (tin & zinc)	48h (cadmium)	
	Damp heat	56 days	56 days	56 days	56 days	56 days	
	Sealing version	No	Yes	No	Yes	Yes	
	Hermeticity	-	-	-	-	Under air helium differential pressure, leakage $\leq 1.04 \times 10^{-5}$ Atm.cm <sup>2</sup> /s	
Standard	NFC 93425	HE501	HE508	-	-	-	
	MIL C 24308 C	-	-	MIL	Compliant to MIL	Compliant to MIL	
Material	Shell	Steel	Steel	Steel	Steel	Steel	
	Housing	Thermoplastic	Thermodur	Thermoplastic	Thermodur	Glass bead	
	Contact	Copper alloy	Copper alloy	Copper alloy	Copper alloy	Ferrous alloy	
Plating	Shell	Cadmium Tin Zinc	Cadmium Tin Zinc	Cadmium	Cadmium Tin Zinc	Cadmium Gold Tin bright Tin mat Nickel	
	Contact	Gold over nickel	Gold over nickel	Gold over nickel	Gold over nickel	Gold Tin mat Nickel	
Electrical	Contact rating (max)	7.5 A	7.5 A	7.5 A	5 A	5 A	
	Test voltage Max Vrms/50Hz	1000 Vrms	1000 Vrms	1000 Vrms	1000 Vrms	750 Vrms	
	Nominal voltage Vrms/50Hz	300 Vrms	300 Vrms	300 Vrms	300 Vrms	N/A	
	Insulation resistance	$\geq 5000 \text{ M}\Omega$	$\geq 5000 \text{ M}\Omega$	$\geq 5000 \text{ M}\Omega$	$\geq 5000 \text{ M}\Omega$	$\geq 5000 \text{ M}\Omega$	
	Contact resistance	$\leq 7.3 \text{ M}\Omega$	$\leq 7.3 \text{ M}\Omega$	$\leq 7.3 \text{ M}\Omega$	$\leq 7.3 \text{ M}\Omega$	$\leq 14 \text{ M}\Omega$	
Mechanical & Dimensional	Insertion/ extraction force per contact (N)	5N max/0.3 min	5N max/0.3 min	5N max/0.3 min	5N max/0.3 min	N/A	
	Endurance	500	500	500	500	500	
	Contact Ø	1 mm	1 mm	1 mm	0.76 mm	1 mm	
Wire	Wire gauge	AWG 20 to 28	AWG 20 to 28	AWG 20 to 24	AWG 22 to 28	N/A	
	Max Ø over insulator	1.7 mm	1.7 mm	1.7 mm	1.4 mm	N/A	
Indents version		Available	Available	N/A	Available	N/A	



# D-Subminiature Series

## Layouts

### Male insulator front view

Contacts are individually numbered on both side of insulator.

### Standard connectors: 8630/1 (HE501/HE508), SMA and Hermetic

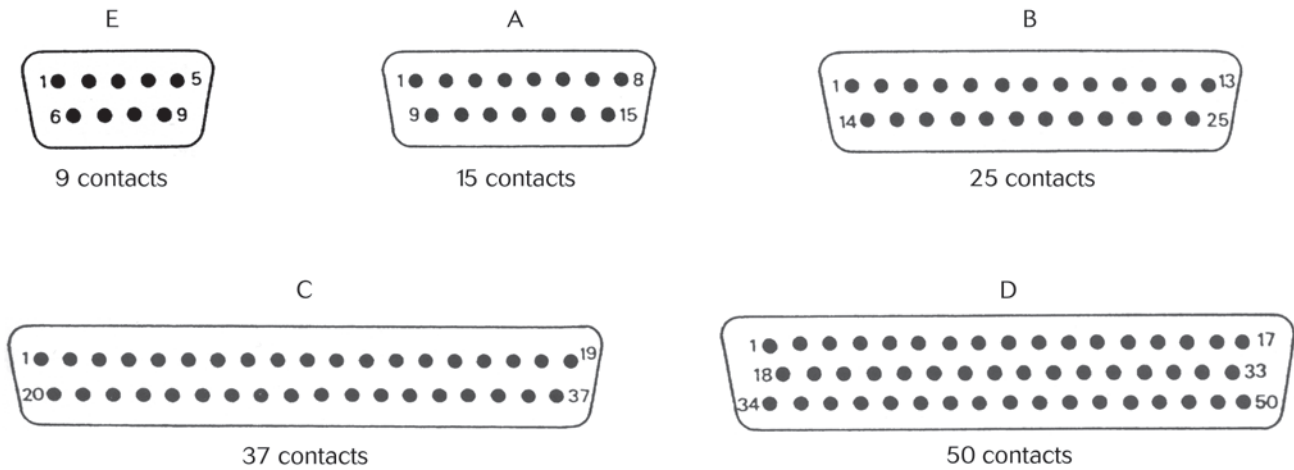

### High density connectors: 8635

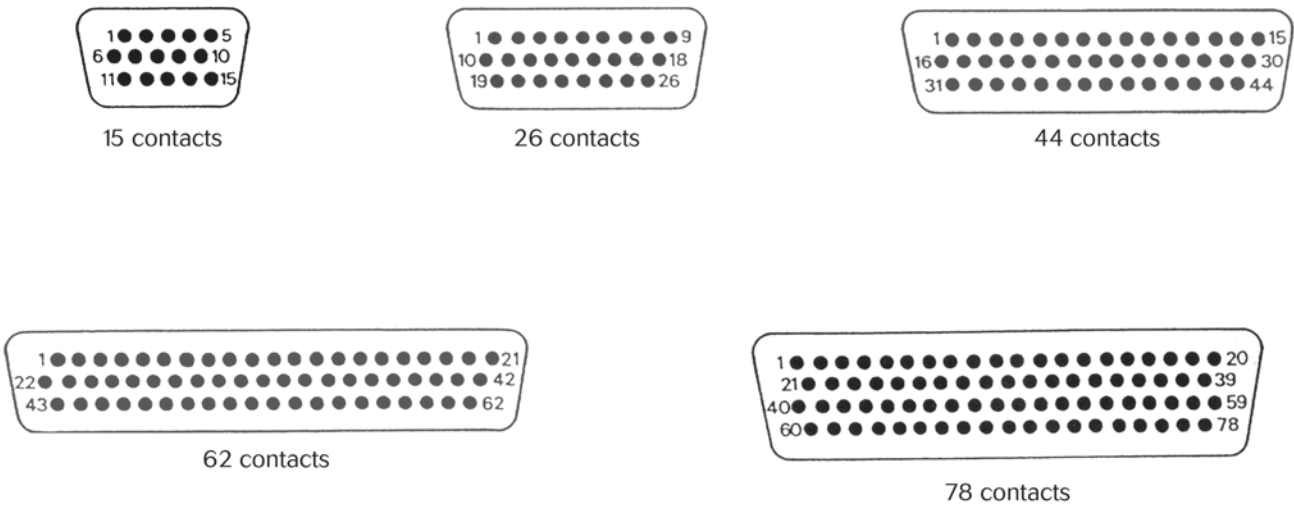



# D-Subminiature Series



## PCB drilling dimensions (mm) for solder version

### Standard connectors: 8630/1 (HE501/HE508), SMA and Hermetic

Note:  $\varnothing A = 0.9\text{mm}$  for HE501, HE508 and MIL C.



### High density connectors: 8635

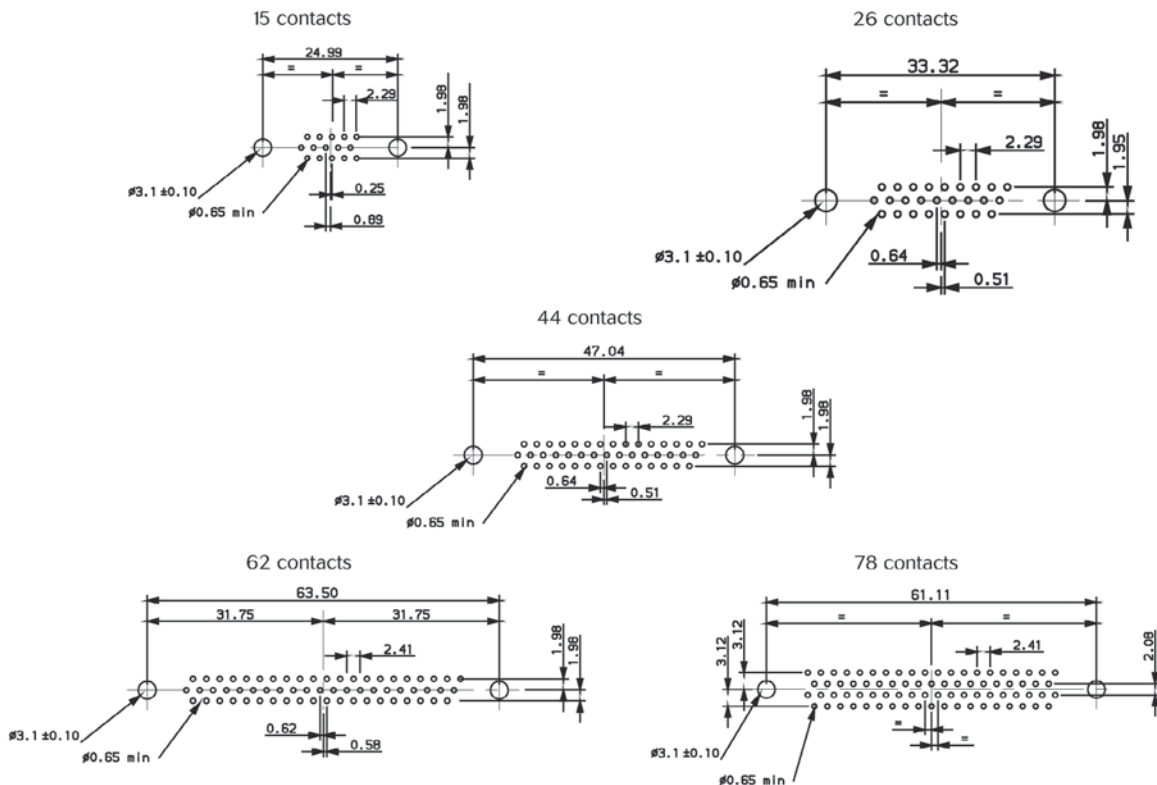

# D-Sub Series



## D-Subminiature Series

# Series

■ 8630 Series HE501 .....	12
■ 8630 Series HE508 .....	14
■ SMA MIL-C Series .....	16
■ 8635 Series .....	19
■ D-Sub hermetic connectors .....	21



# D-Subminiature Series



## 8630 Series HE501

**Connector accomodating removable machined crimp contacts for 20/24 or 26/28 AWG wires**

In compliance with NFC 93425/HE501  
Standard shell plating: Cadmium  
Other platings: Tin & Zinc



## Ordering information

<b>Basic Series</b>	<b>8630</b>	<b>25</b>	<b>P</b>	<b>L</b>
<b>Basic Series (float mounting)</b>	<b>8631</b>	<b>25</b>	<b>P</b>	<b>L</b>
<b>Option</b>				
<b>None:</b> Standard				
L: Clinch nut M3 (8630 only)				
O: Clinch nut UNC 4.40 (8630 only)				
V: Female screw lock UNC 4.40 (8630 only)				
<b>Number of contacts</b>				
09, 15, 25, 37, 50				
<b>Contact type</b>				
P: Pin				
S: Socket				
<b>Contacts</b>				
<b>None:</b> With standard 20/24 AWG contacts				
L: Without contacts				
<b>Rear type</b>				
<b>None:</b> Standard				
H: Shielding termination fingers (only for T plating)				
<b>Shell plating</b>				
<b>None:</b> Cadmium				
T: Tin				
Z: Zinc				
<b>Front type</b>				
<b>None:</b> Standard				
X: With indents (only for front of male connector)				

# D-Subminiature Series



## 8630 Series HE501

### Removable crimp contact ordering information



AWG	Pin	Socket	ØA
AWG 26/28	8631-4111	8631-6121	0.6
AWG 20/24	8630-162	8630-165	1.17

### Cross reference list for qualified part number HE501 & SOURIAU

Examples:

HE501 F 25 BP = 8631 25 P

HE501 N 37 BS = 8630 37 S

Connector type		HE501	SOURIAU Reference	
Removal crimp contact AWG 20/24	Standard	Pin	HE501 N ** BP	8630 ** P
		Socket	HE501 N ** BS	8630 ** S
	Float mounting	Pin	HE501 F ** BP	8631 ** P
		Socket	HE501 F ** BS	8631 ** S



# D-Subminiature Series



## 8630 Series HE508

### Cross reference list for qualified part number HE508 & SOURIAU

Example:  
HE508 N 25 BP = 8630 25 PN

Connector type			HE508	SOURIAU Ref
Removal crimp contact AWG 20/24	Standard	Pin	HE508 N ** BP	8630 ** PN
		Socket	HE508 N ** BS	8630 ** SN
	Float mounting	Pin	HE508 F ** BP	8631 ** PN
		Socket	HE508 F ** BS	8631 ** SN

### Special proof versions (available in HE508 Series only)

Examples:  
8630 25 P012  
**012:** Splash proof version, grommet + potting = male interface seal conform to IP65.  
8630 25 P015  
**015:** Dust proof version, rear grommet only.

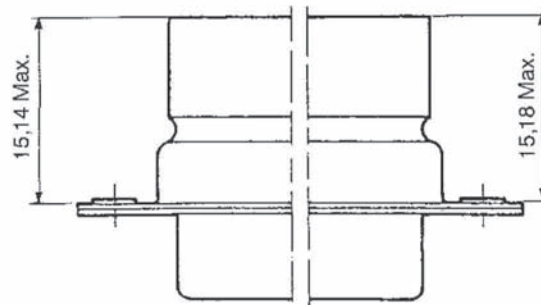
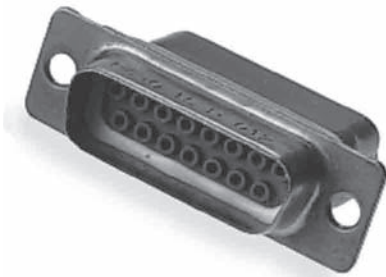

# D-Subminiature Series



## SMA MIL-C Series

**MIL C 24308 C**  
**Connector accomodating**  
**removable machined**  
**crimp contacts for 20/24**  
**AWG wires**

Class -55°C to +125°C  
 Shell plating: Cadmium  
 Contact #20



## Ordering information

Basic Series	S	B	MA	25	P	L	N
Shell size E, A, B, C, D							
S-MA Series MA: Mandatory							
Option None: Standard F: Float mounting							
Number of contacts 09, 15, 25, 37, 50							
Type P: Pin S: Socket							
Contact None: With MIL contacts L: Without MIL contacts							
QPL version N: Mandatory for classified QPL version							

Diameter of insulator cable max: 1.6 mm.  
 This series can be ordered directly with MIL part number.



# D-Subminiature Series



## SMA MIL-C Series

### Crimp contact for AWG 20/24 wire

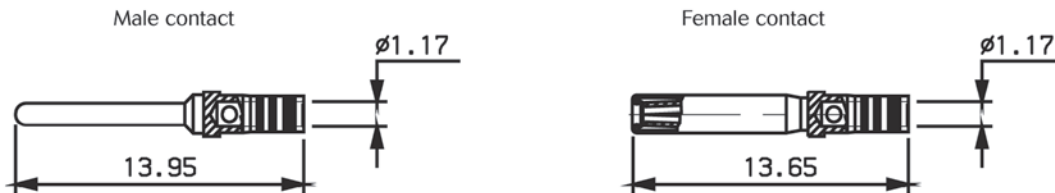

### MIL C 24308 C contact

AWG	Contact type	SOURIAU P/N	Reference	Colour code
20/24	Pin	8630 3020 A	M39029/64-369	Orange/Blue/White
	Socket	8630 3022 A	M39029/63-368	Orange/Blue/Grey

### Tool part number for 8630 Series



Tools	PN	Standard	SOURIAU
		M22520/2-01	8476-01
Locator		M22520/2-08	8476-08
Extraction plastic tool		-	8630-06A
MIL extraction tool		M81969/1-02	8630-3330

# D-Subminiature Series



## SMA MIL-C Series

### MIL Vs SOURIAU cross reference

Connector type	Male connector		Female connector	
	MIL C 24308 C	SOURIAU	MIL C 24308 C	SOURIAU
Standard with contact	M24308/4-1F	SEMA09PN	M24308/2-1F	SEMA09SN
	M24308/4-2F	SAMA15PN	M24308/2-2F	SAMA15SN
	M24308/4-3F	SBMA25PN	M24308/2-3F	SBMA25SN
	M24308/4-4F	SCMA37PN	M24308/2-4F	SCMA37SN
	M24308/4-5F	SDMA50PN	M24308/2-5F	SDMA50SN
Standard without contact	M24308/4-259F	SEMA09PLN	M24308/2-281F	SEMA09SLN
	M24308/4-260F	SAMA15PLN	M24308/2-282F	SAMA15SLN
	M24308/4-261F	SBMA25PLN	M24308/2-283F	SBMA25SLN
	M24308/4-262F	SCMA37PLN	M24308/2-284F	SCMA37SLN
	M24308/4-263F	SDMA50PLN	M24308/2-285F	SDMA50SLN
Float mounting with contact	M24308/4-302F	SEMAF09PN	M24308/2-342F	SEMAF09SN
	M24308/4-303F	SAMAF15PN	M24308/2-343F	SAMAF15SN
	M24308/4-304F	SBMAF25PN	M24308/2-344F	SBMAF25SN
	M24308/4-305F	SCMAF37PN	M24308/2-345F	SDMAF37SN
	M24308/4-306F	SDMAF50PN	M24308/2-346F	SEMAF50SN
Float mounting without contact			M24308/2-482F	SEMAF09SLN
			M24308/2-483F	SAMAF15SLN
			M24308/2-484F	SBMAF25SLN
			M24308/2-485F	SCMAF37SLN
			M24308/2-486F	SDMAF50SLN

# D-Subminiature Series



## 8635 Series

### High density connector

SOURIAU 8635 connector for aerospace and military applications offer high density (size 22) crimp and straight spill contacts in standard A, B, C, D, E shells.

The 8635 connector meet the requirements of MIL C 24308 dust and splash proof specifications.

Standard shell plating: Cadmium  
Other platings: Tin & Zinc



## Ordering information

Basic Series	8635	44	P	012	L				
<b>Option</b>	<p><b>None:</b> Standard mounting holes (Ø=3.10)  <b>F:</b> Float mounting  <b>L:</b> Clinch nut M3  <b>O:</b> Clinch nut UMC 4.40  <b>V:</b> Female screw lock UNC 4.40</p>								
<b>Number of contacts</b>	15, 26, 44, 62, 78								
<b>Contact type</b>	<p><b>P:</b> Pin  <b>S:</b> Socket</p>								
<b>Specification</b>	<p><b>None:</b> Standard  <b>012:</b> Splash proof  <b>015:</b> Dust proof  <b>017:</b> Straight spills</p>								
<b>Contacts</b>	<p><b>None:</b> With standard 20/24 AWG contacts  <b>L:</b> Without contact</p>								
<b>Rear type</b>	<p><b>None:</b> Standard  <b>H:</b> Shielding termination fingers (only for T plating)</p>								
<b>Shell plating</b>	<p><b>None:</b> Cadmium  <b>T:</b> Tin  <b>Z:</b> Zinc</p>								
<b>Front type</b>	<p><b>None:</b> Standard  <b>X:</b> With indents (only for front of male connector)</p>								

Diameter of insulator cable max: 1.4 mm.

# D-Subminiature Series



## 8635 Series

### Dimensions

Standard version  
(crimp contacts)



Straight spill version  
(spec 017)



### Contact part numbers

	Type	Part number
Standard	Pin	8635-4100
	Socket	8635-9100
MIL C 24308	Pin	8635-4110
	Socket	8635-9110

### Tooling part numbers

Contact size	Contact type	Plier Part number		Locator Part number		Plastic insertion/extraction tool Part number
		Souriau	Standard	Souriau	Standard	Standard
#22D	Pin	8476-01	M22520/2-01	8476-09	M22520/2-09	M81969 14-01
	Socket			8476-06	M22520/2-06	



# D-Subminiature Series

## D-Sub hermetic connectors

### D-Sub hermetic connector

Hermetic rectangular connectors are manufactured with glass bead insulator.

They are used in all applications requiring perfect hermeticity.

Shell housing may be solder or screw mounted.

3 types of contacts terminations are available: Solder bucket, Solder eyelet or Straight spill.

They are compliant to MIL C 24308 C.

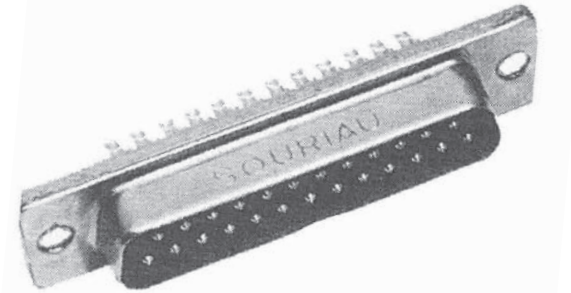

## Dimensions (mm)

Shell size	A <sub>0/+0.30</sub>	B	C Screw mounting	D	E <sub>0/+0.30</sub>	G max	H <sub>+/-0.20</sub>	J <sub>+/-0.20</sub>	K <sub>+0.10 -0.20</sub>
E	30.80	16.94	24.99	8.41	12.54	8.45	18.40	9.40	2.50
A	39.14	25.27	33.32				23.70		
B	53.03	39.00	47.04				37.56		
C	69.29	55.45	63.50	11.10	15.36	8.75	53.97	12.70	2.70
D	66.92	52.86	61.11				50.80		

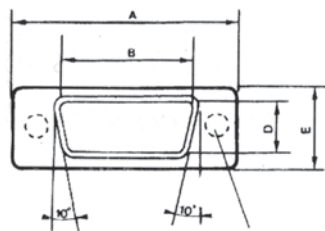

Hole  $\varnothing 3.20$   $\begin{matrix} 0.10 \\ 0.05 \end{matrix}$   
for screw mounting

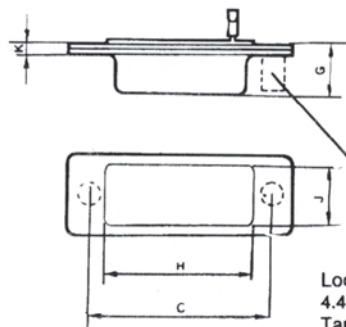

Locking stud  
4.40 UNC 2B  
Tapped hole

Solder bucket

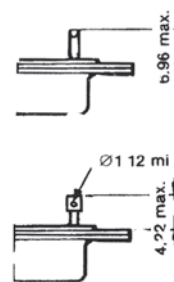

Straight spills





# D-Subminiature Series

## Part numbers & specifications

Shell size	Plating		Solder mounting				Screw mounting		
	Shell	Cts	With locking stub		Without locking stub		Solder bucket	Straight spill	Eyelet
			Solder bucket	Straight spill	Solder bucket	Straight spill			
E 9 Cts	Cadmium	Gold	DEH09P002	DEH09P004	DEH09P006	DEH09P008	DEH09P102	DEH09P104	-
	Cadmium	Gold	-	DEH09P014	-	-	-	-	-
	Gold	Gold	-	-	-	-	DEH09P122	DEH09P124	-
	Tin bright	Gold	DEH09P007	DEH09P012	DEH09P023	DEH09P010	DEH09P107	DEH09P113	-
	Tin bright	Gold	-	DEH09P015	DEH09P025	-	-	DEH09P116	-
	Tin bright	Gold	-	DEH09P016	DEH09P005	-	-	-	-
	Tin bright	Gold	-	DEH09P017	-	-	-	-	-
	Tin mat	Tin mat	-	-	-	DEH09P009	-	-	-
	Nickel	Nickel	-	-	-	-	-	-	DEH09P121
A 15 Cts	Cadmium	Gold	DAH15P002	DAH15P004	DAH15P006	DAH15P008	DAH15P102	DAH15P104	-
	Cadmium	Gold	-	DAH15P014	-	-	-	-	-
	Gold	Gold	-	-	-	-	DAH15P122	DAH15P124	-
	Tin bright	Gold	DAH15P007	DAH15P012	DAH15P023	DAH15P010	DAH15P107	DAH15P113	-
	Tin bright	Gold	-	DAH15P015	DAH15P005	-	DAH15P119	DAH15P116	-
	Tin bright	Gold	-	DAH15P016	-	-	DAH15P120	-	-
	Tin mat	Tin mat	-	-	-	DAH15P009	-	-	-
B 25 Cts	Cadmium	Gold	DBH25P002	DBH25P004	DBH25P006	DBH25P008	DBH25P102	DBH25P104	-
	Cadmium	Gold	-	DBH25P014	DBH25P020	-	-	-	-
	Gold	Gold	-	-	-	-	DBH25P122	DBH25P124	-
	Tin bright	Gold	DBH25P007	DBH25P011A	DBH25P023	DBH25P010	DBH25P107	DBH25P113	-
	Tin bright	Gold	-	DBH25P012	DBH25P005	-	-	DBH25P115	-
	Tin bright	Gold	-	DBH25P015	-	-	-	DBH25P116	-
	Tin bright	Gold	-	DBH25P016	-	-	-	-	-
	Tin bright	Gold/Tin	-	-	-	-	-	DBH25P125	-
	Tin mat	Tin mat	-	-	-	DBH25P009	-	-	-
C 37 Cts	Cadmium	Gold	DCH37P002	DCH37P004	DCH37P006	DCH37P008	DCH37P102	DCH37P104	-
	Cadmium	Gold	-	DCH37P014	-	-	-	-	-
	Gold	Gold	-	-	-	-	DCH37P122	DCH37P124	-
	Tin bright	Gold	DCH37P007	DCH37P012	DCH37P023	DCH37P010	DCH37P107	DCH37P113	-
	Tin bright	Gold	-	DCH37P015	DCH37P005	DCH37P021	-	DCH37P114	-
	Tin bright	Gold	-	DCH37P016	-	-	-	DCH37P116	-
	Tin mat	Tin mat	-	-	-	DCH37P009	-	-	-
D 50 Cts	Cadmium	Gold	DDH50P002	DDH50P004	DDH50P006	DDH50P008	DDH50P102	DDH50P104	-
	Cadmium	Gold	-	DDH50P014	-	-	-	-	-
	Gold	Gold	-	-	-	-	DDH50P122	DDH50P124	-
	Tin bright	Gold	DDH50P007	DDH50P012	DDH50P023	DDH50P010	DDH50P107	DDH50P113	-
	Tin bright	Gold	-	DDH50P015	DDH50P005	-	-	DDH50P114	-
	Tin bright	Gold	-	DDH50P016	DDH50P019	-	-	DDH50P116	-
	Tin mat	Tin mat	-	-	-	DDH50P009	-	-	-

# D-Subminiature Series



## D-Sub hermetic connectors

### Straight spill version dimensions

N° specification	004	008	009	010	011A	012	014	015	016
L max	7.62				3.40	5.25	3.83	9.60	7.62
E min	6.40				2.00	4.02	2.13	8.43	6.40
ø D max	0.83				0.60	0.68	0.63	0.83	0.83

N° specification	017	021	104	113	114	115	116	124	125
L max	3.83	7.62		6.82		16.35	7.62		
E min	2.13	6.40		5.60		15.18	6.40		
ø D max	0.60	0.83		0.65		0.85	0.83		

### Panel cut-out

Shell size	Mounting type	A +/-0.1	B +/-0.1	C +/-0.1	D +/-0.05	E +/-0.1	F min	G min
E	Front	-	-	24.99	3.20	-	18.70	9.70
	Rear	20.50	11.40	24.99	3.20	3.30	-	-
A	Front	-	-	33.32	3.20	-	24.00	9.70
	Rear	28.80	11.40	33.32	3.20	3.30	-	-
B	Front	-	-	47.04	3.20	-	37.80	9.70
	Rear	42.50	11.40	47.04	3.20	3.30	-	-
C	Front	-	-	63.50	3.20	-	54.20	9.70
	Rear	59.10	11.40	63.50	3.20	3.30	-	-
D	Front	-	-	61.11	3.20	-	51.10	13.00
	Rear	56.30	11.40	61.11	3.20	3.30	-	-

Cut-out front panel mounting  
(screw mounting)

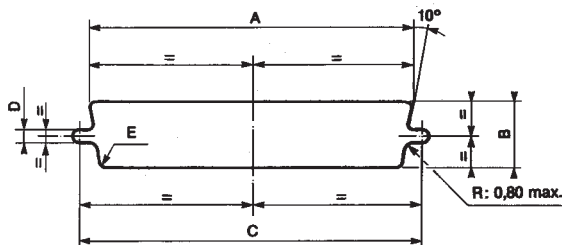

Cut-out rear panel mounting  
(screw mounting)

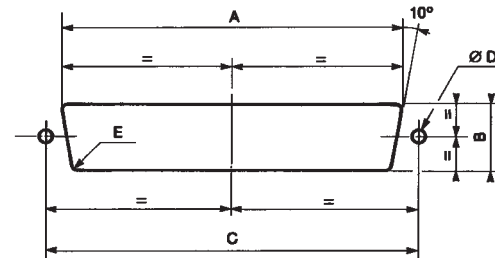

# D-Sub Series





D-Subminiature Series

# Common Section

■ Panel mounting .....	26
■ Shell dimensions .....	27
■ Mounting options .....	28





# D-Subminiature Series

## Panel mounting

It is recommended that only one pair of connectors should be float mounted.  
 Rigid mounted connectors require 2 screws Ø3mm.  
 Float mounting connectors require Ø2mm.



Shell size	A 0/+0.6	B 0/+0.6	C 0/+0.6	D 0/+0.6	E 0/+0.6	F 0/+0.6	G 0/+0.6	H 0/+0.6	J 0/+0.6	K 0/+0.6	L 0/+0.6	M 0/+0.6				
E	7.65	7.65	6.85	6.45	8.85	5.65	8.25	9.45	5.65	8.25	9.45	6.85				
A																
B					9.15	5.55	8.15	9.35	5.55	8.15	9.35	6.75				
C	7.55	7.55	6.75	6.35							8.35				9.75	7.15
D																



# D-Subminiature Series

## Shell dimensions

Inner dimension  
male connector

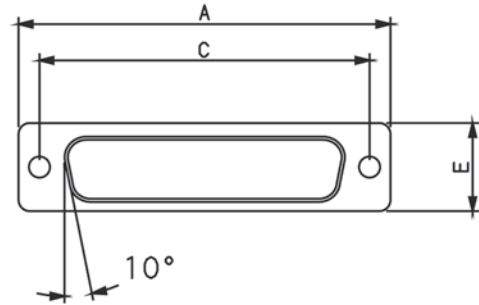
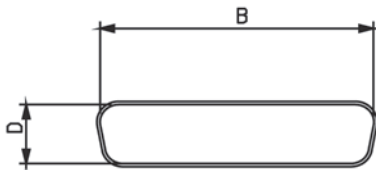

View of  
mating faces

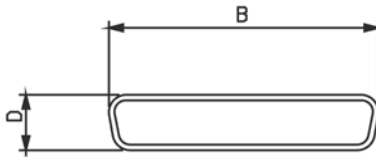
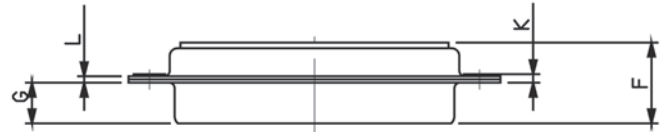

Outer view  
female connector

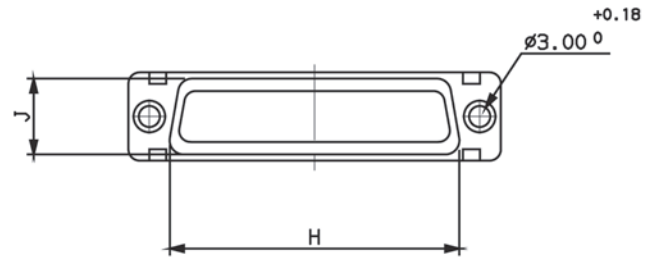

Shell size	Contact type	A +/-0.38	B +/-0.13	C +/-0.13	D +/-0.13	E +/-0.38	F Max	G +/-0.25	H +/-0.25	J +/-0.25	K Max	L +/-0.12
E	Pin	30.81	16.91	24.99	8.35	12.55	10.99	5.85	19.27	10.71	1.50	0.90
	Socket		16.33		7.89		11.21	6.05				
A	Pin	39.14	25.24	33.32	8.35		10.99	5.85	27.50			
	Socket		24.66		7.89		11.21	6.05				
B	Pin	53.03	38.96	47.04	8.35		11.07	5.75	41.27			
	Socket		38.37		7.89		11.21	6.05				
C	Pin	69.32	55.42	63.50	8.35	11.09	5.75	57.70				
	Socket		54.83		7.89	11.21	6.05					
D	Pin	66.93	52.80	61.11	11.20	15.37	11.09	5.75	55.32	13.56	1.70	1.00
	Socket		52.42		10.74		11.21	6.05			1.50	



# D-Subminiature Series

## Mounting options

### 8630 and 8635 Series (dimensions in mm.)

F: Float mounting

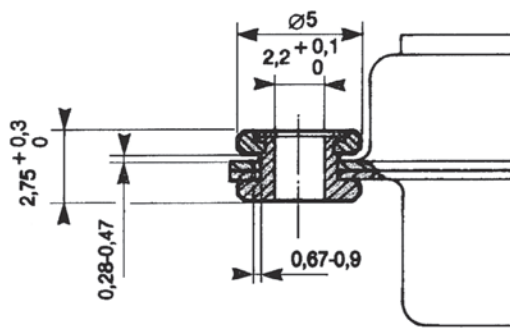

L: Clinch nut M3  
O: Clinch nut UNC 4-40



Clinch nut M3 or UNC 4-40

V: Female screw lock UNC 4-40

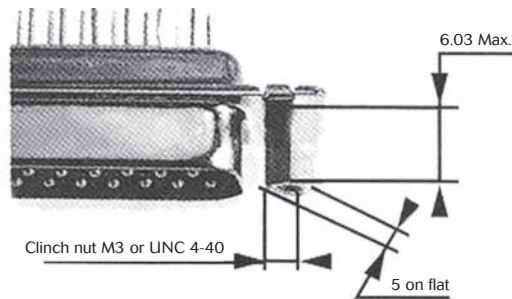





[www.souriau.com](http://www.souriau.com)  
[contactmilaero@souriau.com](mailto:contactmilaero@souriau.com)



**SOURIAU**