

MIL-DTL-38999, Series I LJT, II JT, III TV Insert Availability and Identification Chart



| Series | Series | Series | Military | JT/LJT | Hermetics | | | | | Contact Size | | | | | | | | | | | |
|--------|--------|---------|----------|--------|-----------|---|---|-----|----------------|----------------|-----|-----|----|----|----|----|-----------|------------|----------|--------------|-----------|
| JT II | LJT I | TV III | TV III | Solder | Crimp | H | Y | TV* | Service Rating | Total Contacts | 22D | 22M | 22 | 20 | 16 | 12 | 12 (Coax) | 10 (Power) | 8 (Coax) | 8†† (Twinax) | 8 Quadrax |
| 24-35 | | | | | X | P | P | | New | 128 | 128 | | | | | | | | | | |
| | 25-35 | 25-35 | J35 | | X | P | P | P | M | | | | | | | | | | | | |
| 24-37 | | | | | X | | | | I | 37 | | | | 37 | | | | | | | |
| | 25-37★ | 25-37★ | J37 | | X | | | | I | | | | | | | | | | | | |
| 24-43■ | | | | | 3 | | | | I | 43 | | | | 23 | 20 | | | | | | |
| | 25-43 | 25-43 | J43 | X | 2 | ♦ | | | I | | | | | | | | | | | | |
| | 25-46 | 25-46 | J46 | | 2 | ♦ | | | I | 46 | | | | 40 | 4 | | | | 2 | | |
| 24-61 | | | | | X | X | P | P | I | | | | | | | | | | | | |
| | 25-61 | 25-61 | J61 | X | X | P | P | P | I | 61 | | | | 61 | | | | | | | |
| | | 25-62■ | | | X | ♦ | | | I | | | | | | | | | | | | |
| | | 25-90■ | | | ♦ | | | | I | 46 | | | | 40 | 4 | | | | | 2 | |
| | | 25-F4 ■ | | | X | | | | M/I | | | | | | | | | | | | |
| | | | | | | | | | | 66 | 49 | | | | 13 | 4 | | | | | |

- X Completely tooled.
- ♦ Not tooled for 02-R.
- P Pin inserts only (contact Amphenol Aerospace for socket availability).
- ★ Ground plane proprietary option available. Arrg. 9-5 is exclusively ground plane type.
- Not Mil-Qualified.

TV Series III

Select Shell Size - Special Insert Arrangement

(Not Mil-Spec Qualified)

| Shell Size-Insert Arrg. | Crimp | Hermetics* | Service Rating | Total Contacts | Comments | Contact Size | | | | |
|-------------------------|-------|------------|----------------|----------------|------------------|--------------|----|----|----|--------------|
| | | | | | | 22D | 20 | 16 | 12 | 8†† (Twinax) |
| 9-2 | X | | I | 2 | Formerly Pyle | | 2 | | | |
| 15-4 | X | | II | 4 | Formerly Pyle | | | 4 | | |
| 15-25 | X | | M | 25 | Formerly Pyle | 22 | | 3 | | |
| 17-20 | X | | M | 20 | Formerly Pyle | | 16 | 4 | | |
| 21-12 | X | | I | 12 | Formerly Pyle | | 3 | | 9 | |
| 21-21 | X | | M/Inst. | 41 | Improved sealing | 32 | | | 9 | |
| 21-99 | X | | M | 16 | Formerly Pyle | 5 | | | 11 | |
| 25-92 | X | | M | 101 | Formerly Pyle | 92 | | 9 | | |
| 25-97 | X | | M | 42 | Formerly Pyle | 26 | | 3 | 13 | |

Select Non-Standard Shell Size

- Special Insert Arrangement

| Shell Size-Insert Arrg. | Crimp | Hermetics* | Service Rating | Total Contacts | Contact Size | | | | |
|-------------------------|-------|------------|----------------|----------------|--------------|----|---|---|---|
| | | | | | 22D | 20 | 8 | 4 | 0 |
| 25-16 | X | | M | 8 | | 6 | | 2 | |
| 25L-3 | X | | II | 3 | | | 1 | 2 | |
| 25L-7 | X | | II | 7 | | | 7 | | |
| 33-3 | X | | II | 3 | | | | 1 | 2 |
| 33-5 | X | | II | 5 | | | | 5 | |
| 33-6 | X | | II | 6 | | | 2 | 4 | |
| 37-5 | X | | II | 4 | | | | | 4 |

(Insert arrangements requiring non-standard shells or larger contacts)

- X Completely tooled.
 - Majority of tooling is completed (contact Amphenol Aerospace for availability).
 - ♦ Not tooled for 02-R.
 - P Pin inserts only (contact Amphenol Aerospace for socket availability).
 - ★ Ground plane proprietary option available. Arrangement 9-5 is exclusively ground plane type.
 - Not Mil-Qualified.
 - * Hermetic inserts - solder termination standard. (Contact Amphenol Aerospace for optional PCB or eyelet termination).
 - ** Two size 16 contacts dedicated to fiber optics. See the Fiber Optic section for more information.
 - *** For use in MIL-STD-1760 applications (pgs. 40 & 41).
 - † For RG 180/U and RG 195/U cables only.
 - †† Size 8 Coax and Twinax are interchangeable.
- Note: 25L-3 and 25L-7 require longer shells.

III II I **38999**
SJT

26482
Matrix 2

83723 III
Matrix Pyle

5015
Crimp Rear Release Matrix

26500 Pyle

Printed
Circuit Board

EMI Filter
Transient

Fiber Optics

High Speed
Contacts

Options
Others

Front face of pin inserts illustrated

38999

SJT

III
II
I

Shell Size & Insert Arrg. for:



| | | | | | | | | | | | |
|----------------------|-----|-----|----------|-----|-----|------|------|------|------|------|------|
| Series II JT | 8-2 | 8-3 | | 8-6 | | | 8-35 | 8-44 | | 8-97 | 8-98 |
| Series I LJT | | 9-3 | | 9-6 | 9-7 | 9-22 | 9-35 | 9-44 | | | 9-98 |
| Series III TV | | | 9-5 | | | | 9-35 | | 9-94 | | 9-98 |
| Service Rating | M | M | Grounded | M | M | I | M | M | M | M | I |
| Number of Contacts | 2 | 3 | 1 | 6 | 7 | 2 | 6 | 4 | 2 | 2 | 3 |
| Contact Size | 20 | 20 | 8 Twinax | 22M | 22M | 20 | 22D | 22 | 20 | 22M | 20 |

26482

Matrix 2

Shell Size & Insert Arrg. for:

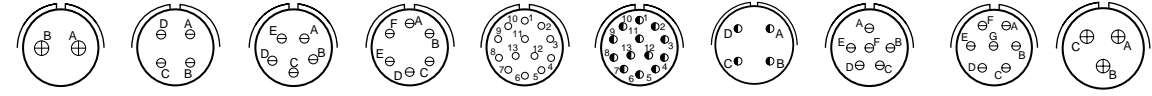

| | | | | | | | | | | |
|----------------------|------|------|------|------|-------|-------|-------|-------|-------|------|
| Series II JT | | 10-4 | 10-5 | | 10-13 | 10-35 | | 10-98 | 10-99 | 12-3 |
| Series I LJT | 11-2 | 11-4 | 11-5 | 11-6 | 11-13 | 11-35 | | 11-98 | 11-99 | 13-3 |
| Series III TV | 11-2 | 11-4 | 11-5 | | | 11-35 | 11-54 | 11-98 | 11-99 | |
| Service Rating | I | I | I | I | M | M | II | I | I | II |
| Number of Contacts | 2 | 4 | 5 | 6 | 13 | 13 | 4 | 6 | 7 | 3 |
| Contact Size | 16 | 20 | 20 | 20 | 22M | 22D | 22D | 20 | 20 | 16 |

5015

Crimp Rear Release Matrix

Shell Size & Insert Arrg. for:

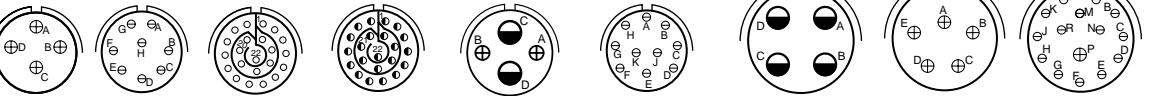

| | | | | | | | | | | | |
|----------------------|------|------|-------|-------|-------|-------|------|-------|-------|----|----|
| Series II JT | 12-4 | 12-8 | 12-22 | 12-35 | | 12-98 | 14-4 | 14-5 | 14-15 | | |
| Series I LJT | 13-4 | 13-8 | 13-22 | 13-35 | | 13-98 | 15-4 | 15-5 | 15-15 | | |
| Series III TV | 13-4 | 13-8 | 13-35 | 13-63 | 13-98 | 15-4 | 15-5 | 15-15 | | | |
| Service Rating | I | I | M | M | I | I | I | II | I | | |
| Number of Contacts | 4 | 8 | 22 | 22 | 2 | 2 | 10 | 4 | 5 | 14 | 1 |
| Contact Size | 16 | 20 | 22M | 22D | 16 | 12 | 20 | 12 | 16 | 20 | 16 |

Printed Circuit Board

Shell Size & Insert Arrg. for:

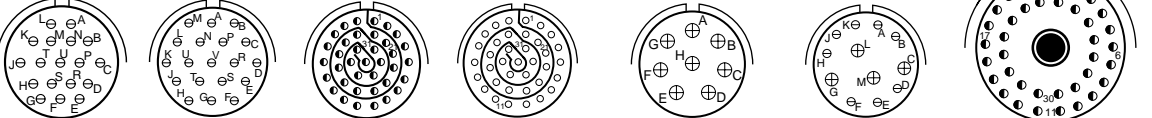

| | | | | | | | | | |
|----------------------|-------|-------|-------|-------|-------|-------|------|-----|----------|
| Series II JT | 14-18 | 14-19 | 14-35 | 14-37 | 14-68 | 14-97 | | | |
| Series I LJT | 15-18 | 15-19 | 15-35 | 15-37 | 15-68 | 15-97 | 17-2 | | |
| Series III TV | 15-18 | 15-19 | 15-35 | | | 15-97 | 17-2 | | |
| Service Rating | I | I | M | M | I | I | M | | |
| Number of Contacts | 18 | 19 | 37 | 37 | 8 | 8 | 4 | 38 | 1 |
| Contact Size | 20 | 20 | 22D | 22M | 16 | 20 | 16 | 22D | 8 Twinax |

EMI Filter Transient

Fiber Optics

Shell Size & Insert Arrg. for:

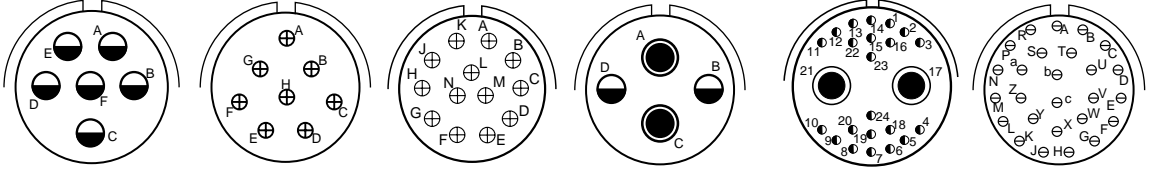

| | | | | | | | | |
|----------------------|------|------|-------|---------|--------|-----|--------|----|
| Series II JT | 16-6 | 16-8 | 16-13 | | | | 16-26 | |
| Series I LJT | 17-6 | 17-8 | 17-13 | 17-22 | 17-25 | | 17-26 | |
| Series III TV | 17-6 | 17-8 | 17-22 | | | | 17-26 | |
| Service Rating | I | II | I | Coax | M | I | | |
| Number of Contacts | 6 | 8 | 13 | 2 | 2 | 22 | 2 | |
| Contact Size | 12 | 16 | 16 | 12 Coax | 8 Coax | 22D | 8 Coax | 20 |

High Speed Contacts

Options Others

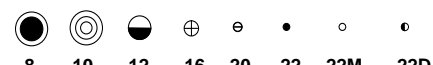

CONTACT LEGEND 8 10 12 16 20 22 22M 22D

MIL-DTL-38999, Series I LJT, II JT, III TV

Insert Arrangements

Front face of pin inserts illustrated

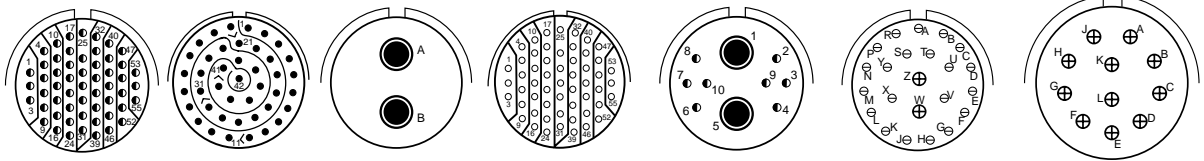

Shell Size & Insert Arrg. for:

| | | | | | |
|----------------------|-------|-------|----------|--------|--------|
| Series II JT | 16-35 | 16-42 | 16-55 | 16-99 | 18-11 |
| Series I LJT | 17-35 | 17-42 | 17-55 | 17-99 | 19-11 |
| Series III TV | 17-35 | | 17-52 | 17-60 | 17-99 |
| Service Rating | M | M | M | I/Coax | I |
| Number of Contacts | 55 | 42 | 55 | 8 | 2 |
| Contact Size | 22D | 22 | 8 Twinax | 22D | 8 Coax |

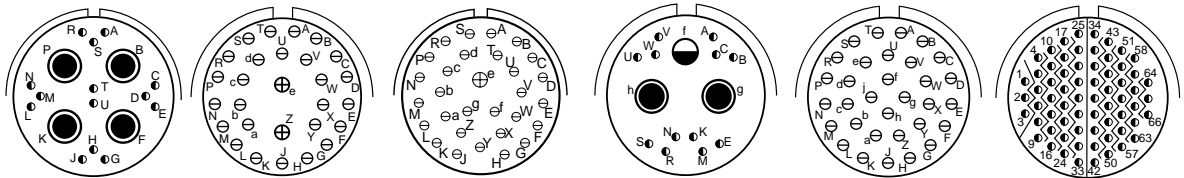

Shell Size & Insert Arrg. for:

| | | | | |
|----------------------|-------|----------|-------|-------|
| Series II JT | 18-28 | 18-30 | 18-32 | 18-35 |
| Series I LJT | 19-18 | 19-28 | 19-32 | 19-35 |
| Series III TV | 19-18 | 19-28 | 19-31 | 19-35 |
| Service Rating | M | M | I | M |
| Number of Contacts | 14 | 4 | 26 | 2 |
| Contact Size | 22D | 8 Twinax | 20 | 18 |

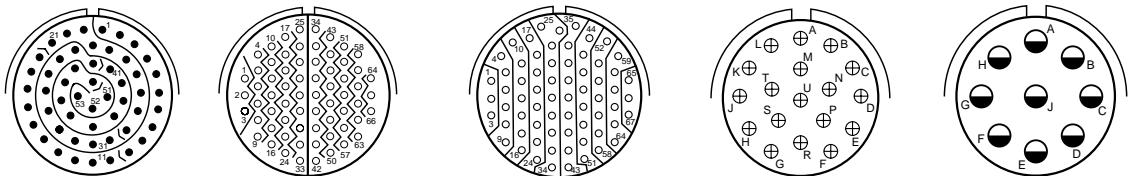

Shell Size & Insert Arrg. for:

| | | | | |
|----------------------|-------|-------|-------|-------|
| Series II JT | 18-53 | 18-66 | 18-68 | 18-96 |
| Series I LJT | 19-53 | 19-66 | 19-67 | 19-68 |
| Series III TV | | | | |
| Service Rating | M | M | M | I |
| Number of Contacts | 53 | 66 | 67 | 18 |
| Contact Size | 22 | 22M | 22M | 16 |

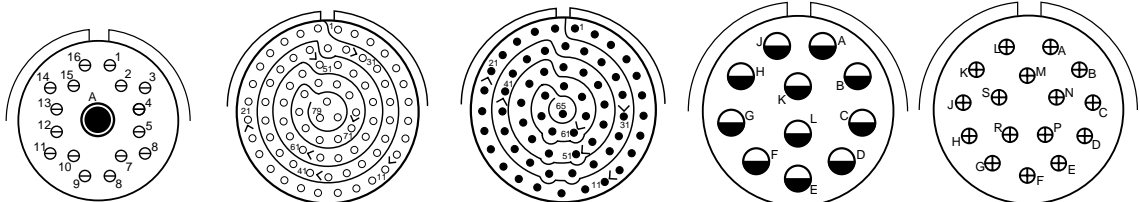

Shell Size & Insert Arrg. for:

| | | | | |
|----------------------|-------|----------|-------|-------|
| Series II JT | 20-1 | 20-2 | 20-11 | 20-16 |
| Series I LJT | 21-1 | 21-2 | 21-11 | 21-16 |
| Series III TV | 19-AD | | 21-11 | 21-16 |
| Service Rating | Inst. | M | M | I |
| Number of Contacts | 16 | 1 | 79 | 65 |
| Contact Size | 20 | 8 Twinax | 22M | 22 |

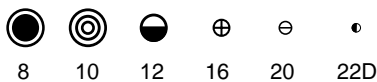

CONTACT LEGEND

- III 38999
- II SJT
- I
- Matrix 2 26482
- Matrix 83723 III
- Pyle 5015
- Crimp Rear Release Matrix
- 26500 Pyle
- Printed Circuit Board
- EMI Filter Transient
- Fiber Optics
- High Speed Contacts
- Options Others

Front face of pin inserts illustrated



Shell Size &
Insert Arrg. for:

| | Series II JT | | Series I LJT | | | Series III TV | | |
|--------------------|--------------|----|--------------|----|----|---------------|-----|--|
| Service Rating | I | I | I | I | I | M | M | |
| Number of Contacts | 25 | 27 | 19 | 4 | 4 | 79 | 79 | |
| Contact Size | 20 | 20 | 20 | 16 | 12 | 22D | 22D | |



Shell Size &
Insert Arrg. for:

| | Series II JT | | Series I LJT | | Series III TV | |
|--------------------|--------------|----|--------------|------------|---------------|-----|
| Service Rating | I | I | N | II | M | M |
| Number of Contacts | 37 | 2 | 41 | 4 | 17 (See Note) | 100 |
| Contact Size | 20 | 16 | 20 | (See Note) | 22D | 22M |



Shell Size &
Insert Arrg. for:

| | Series II JT | | Series I LJT | | Series III TV | |
|--------------------|--------------|----------|--------------|----|---------------|----|
| Service Rating | M | M | I | II | I | I |
| Number of Contacts | 85 | 6 | 14 | 21 | 32 | 32 |
| Contact Size | 22 | 8 Twinax | 12 | 16 | 20 | 20 |

Note: MS connector 21-75 is supplied with four size 8 twinax contacts.
Commercial connector 21-75 is supplied with four size 8 coax contacts.
MS connector 21-79 has provision for two size 8 coax contacts.
Coax contacts are not supplied unless specified by customers.



MIL-DTL-38999, Series I LJT, II JT, III TV

Insert Arrangements



Front face of pin inserts illustrated

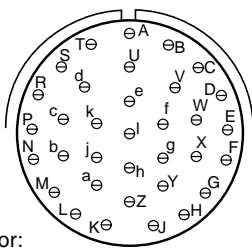

Shell Size & Insert Arrg. for:

| | | | | |
|----------------------|--------------|--------------|--------------|------------------|
| Series II JT | | 22-35 | 22-53 | |
| Series I LJT | 23-34 | 23-35 | 23-53 | |
| Series III TV | | 23-35 | 23-53 | 23-54 |
| Service Rating | I | M | I | M |
| Number of Contacts | 34 | 100 | 53 | 40 9 4 |
| Contact Size | 20 | 22D | 20 | 22D 16 12 |

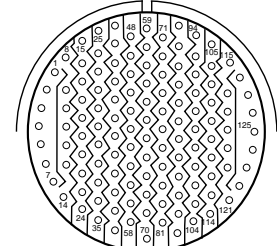
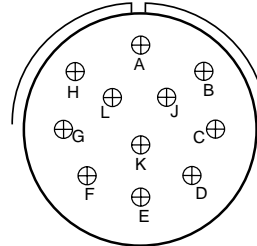
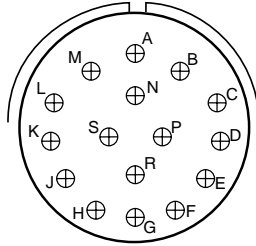
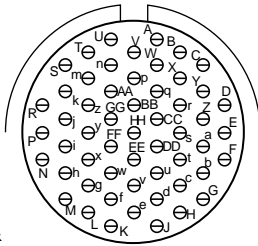

Shell Size & Insert Arrg. for:

| | | | | |
|----------------------|--------------|--------------|--------------|-------------|
| Series II JT | 22-55 | | | 24-1 |
| Series I LJT | 23-55 | 23-97 | 23-99 | 25-1 |
| Series III TV | 23-55 | | | |
| Service Rating | I | II | II | M |
| Number of Contacts | 55 | 16 | 11 | 128 |
| Contact Size | 20 | 16 | 16 | 22M |

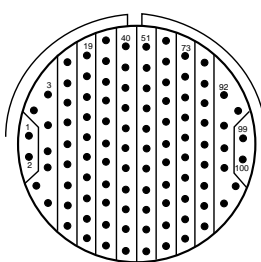

Shell Size & Insert Arrg. for:

| | | | | |
|----------------------|-------------|--------------|---------------------|-----------------|
| Series II JT | 24-2 | 24-4 | | |
| Series I LJT | 25-2 | 25-4 | 25-7 | |
| Series III TV | | 25-4 | 25-7 | 25-8 |
| Service Rating | M | I | M | Twinax |
| Number of Contacts | 100 | 48 8 | 97 2 | 8 |
| Contact Size | 22 | 20 16 | 22D 8 Twinax | 8 Twinax |

*** For use in MIL-STD-1760 applications (see pages 40 and 41).



CONTACT LEGEND 8 10 12 16 20 22D

38999
SJT

26482
Matrix 2

83723 III
Matrix Pyle

5015
Crimp Rear Release Matrix

26500 Pyle

Printed
Circuit Board

EMI Filter
Transient

Fiber Optics

High Speed
Contacts

Options
Others

Front face of pin inserts illustrated

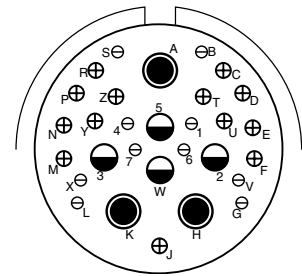
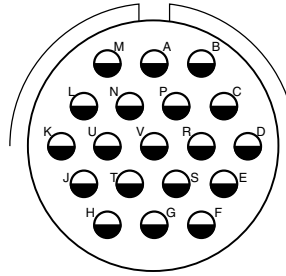
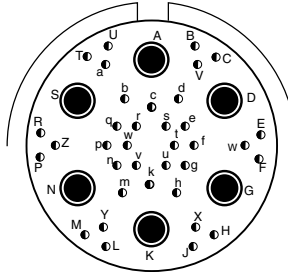
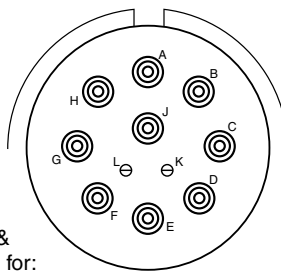

Shell Size & Insert Arrg. for:

| Series II JT | 24-19 | 25-19 | 25-20 |
|--------------------|----------|--------------|------------------------|
| Series I LJT | 25-11 | 25-19 | 25-20 |
| Series III TV | 25-11*** | 25-19 | 25-20*** |
| Service Rating | N | I | N |
| Number of Contacts | 2 9 | 36 6 | 10 13 3 4 |
| Contact Size | 20 10 | 22D 8 Twinax | 20 16 8 Twinax 12 Coax |

(With Matched Impedance)

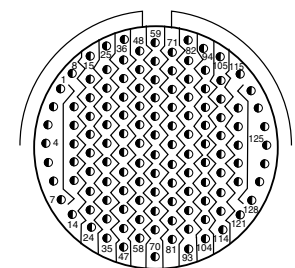
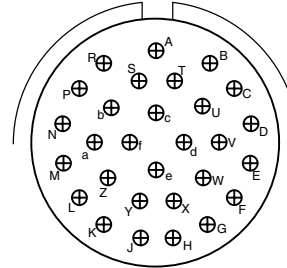
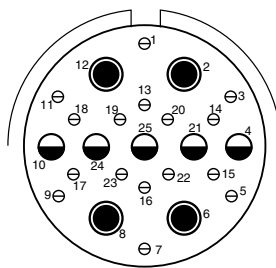
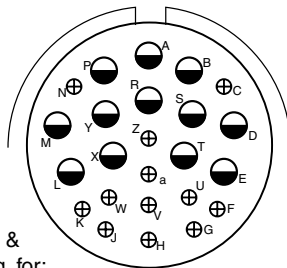

Shell Size & Insert Arrg. for:

| Series II JT | 24-24 | 24-29 | 24-35 |
|--------------------|-------|--------------|--------|
| Series I LJT | 25-24 | 25-29 | 25-35 |
| Series III TV | 25-24 | 25-29 | 25-35 |
| Service Rating | I | I | M |
| Number of Contacts | 12 12 | 16 5 4 | 29 128 |
| Contact Size | 16 12 | 20 12 8 Coax | 16 22D |

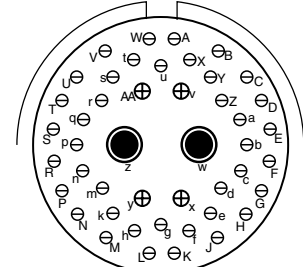
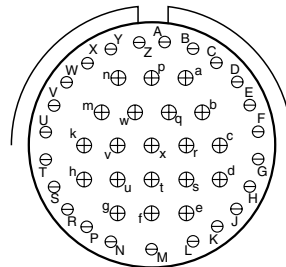
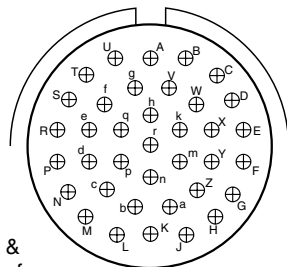

Shell Size & Insert Arrg. for:

| Series II JT | 24-37 | 25-43 | 25-46 |
|--------------------|-------|-------|--------------|
| Series I LJT | 25-37 | 25-43 | 25-46 |
| Series III TV | 25-37 | 25-43 | 25-46 |
| Service Rating | I | I | I |
| Number of Contacts | 37 | 23 20 | 40 4 2 |
| Contact Size | 16 | 20 16 | 20 16 8 Coax |

† Coax contacts for RG180/U or RG195/U cable.



- 38999 SJT I II III
- 26482 Matrix 2
- 83723 III Pyle Matrix
- 5015 Crimp Rear Release Matrix
- 26500 Pyle
- Printed Circuit Board
- EMI Filter Transient
- Fiber Optics
- High Speed Contacts
- Options Others

MIL-DTL-38999, Series I LJT, II JT, III TV Insert Arrangements



Front face of pin inserts illustrated



Shell Size & Insert Arr. for:

Series II JT 24-61

Series I LJT 25-61

Series III TV 25-61

Service Rating

Number of Contacts

Contact Size

25-62

I

8 4

16 8

25-90

I

40 4 2
20 16 8 Twinax

25-F4

Size 22D=M, Balance =I

49 13 4
22D 16 12

MIL-DTL-38999, Series III TV

Special Insert Arrangements

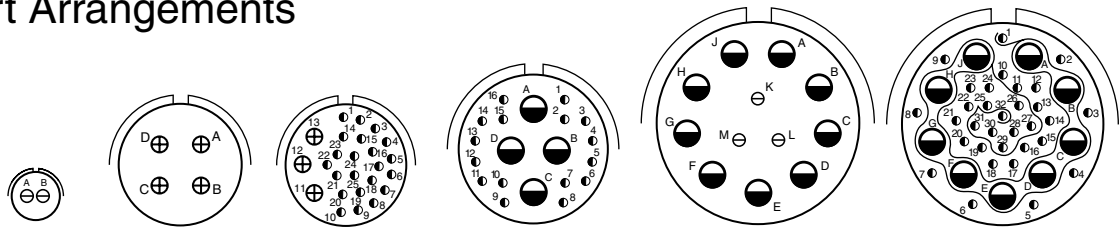

Shell Size & Insert Arr. for:

Series III TV 9-2

15-4*

15-25

17-20

21-12

21-21

Service Rating

Number of Contacts

Contact Size

II

M

M

I

M/Inst.

4

22 3

16 4

3 9

32 9

16

22D 16

22D 12

20 12

22D 12

Shell Size & Insert Arr. for:

Series III TV 21-99

25-92

25-97

Service Rating

Number of Contacts

Contact Size

M

M

M

5 11

92 9

26 3 13

22D 12

22D 16

22D 16 12

NOTE: Some specials shown here were formerly known as Pyle arrangements. Consult Amphenol for how to order information for connectors with these inserts. For further information on special arrangements consult Amphenol Aerospace, Sidney NY.

* Pyle 15-4 does not mate with Amphenol Tri-Start 15-4 insert.

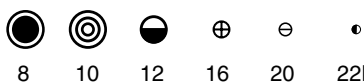

CONTACT LEGEND

8 10 12 16 20 22D

- III 38999
- II I SJT
- Matrix 2 26482
- Matrix 83723 III
- Pyle 5015
- Crimp Rear Release Matrix
- 26500 Pyle
- Printed Circuit Board
- EMI Filter Transient
- Fiber Optics
- High Speed Contacts
- Options Others

Non-Standard Shells or Large Contacts

Front face of pin inserts illustrated

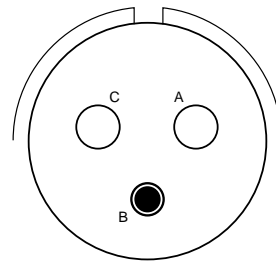

Shell Size &
Insert Arrg. for:

| Series III TV | 25-16 | | 25L-3 | | 25L-7 |
|--------------------|-------|---|-------|---|-------|
| Service Rating | M | | II | | II |
| Number of Contacts | 6 | 2 | 1 | 2 | 7 |
| Contact Size | 20 | 4 | 8 | 4 | 8 |

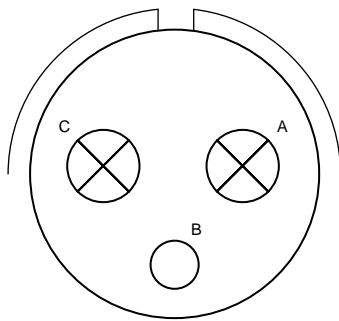

Shell Size &
Insert Arrg. for:

| Series III TV | 33-3 | | 33-5 | 33-6 | |
|--------------------|------|---|------|------|---|
| Service Rating | II | | II | II | |
| Number of Contacts | 1 | 2 | 5 | 2 | 4 |
| Contact Size | 4 | 0 | 4 | 8 | 4 |



Shell Size &
Insert Arrg. for:

| Series III TV | 37-5 |
|--------------------|------|
| Service Rating | II |
| Number of Contacts | 4 |
| Contact Size | 0 |

NOTE: Some specials shown here were formerly known as Pyle arrangements. Consult Amphenol for how to order information for connectors with these inserts.

Consult Amphenol Aerospace for longer shell drawings.



CONTACT LEGEND

- III
- SJT 38999 I II
- 26482 Matrix 2
- 83723 III Pyle Matrix
- 5015 Crimp Rear Release Matrix
- 26500 Pyle
- Printed Circuit Board
- EMI Filter Transient
- Contacts Fiber Optics
- ries
- Options Others

CONTACT RATING

| Contact Size | Test Current (Amps) | | Maximum Millivolt Drop Crimp* | Maximum Millivolt Drop | | Contact Size | Crimp Well Data | | Solder Well Data | |
|--------------|---------------------|----------|-------------------------------|------------------------|-----------|--------------|-----------------|-------------------|---------------------|--------------------|
| | Crimp | Hermetic | | Solder* | Hermetic* | | Well Diameter | Normal Well Depth | Well Diameter | Nominal Well Depth |
| 22M | 3 | 2 | 45 | 20 | 60 | 22M | .028 ± .001 | .141 | .029 +.004 -.000 | |
| 22D | 5 | 3 | 73 | | 85 | 22D | .0345 ± .0010 | .141 | .036 +.004 -.000 | .094 |
| 22 | 5 | 3 | 73 | 20 | 85 | 22 | .0365 ± .0010 | .141 | .036 +.004 -.000 | .094 |
| 20 | 7.5 | 5 | 55 | 20 | 60 | 20 | .047 ± .001 | .209 | .044 +.004 -.004 | .125 |
| 16 | 13 | 10 | 49 | 20 | 85 | 16 | .067 ± .001 | .209 | .078 +.000 -.004 | .141 |
| 12 | 23 | 17 | 42 | 20 | 85 | 12 | .100 ± .002 | .209 | .116 +.004 -.002 | .141 |
| 10 (Power) | 33 | NA | 33 | NA | NA | 10 (Power) | .137 ± .002 | .355 | NA | NA |
| 8 (Power) | 46 | NA | 26 | NA | NA | 8 | .181 ± .002 | .490 | NA | NA |
| 4 | 80 | NA | 23 | NA | NA | 4 | .281 ± .002 | .490 | NA | NA |
| 0 | 150 | NA | 21 | NA | NA | 0 | .453 ± .002 | .585 | NA | NA |

*When tested using silver plated wire.

SERVICE RATING**

| Service Rating | Suggested Oper. Voltage (Sea Level) | | Test Voltage (Sea Level) | Test Voltage 50,000 Ft. | Test Voltage 70,000 Ft. | Test Voltage 110,000 Ft. |
|----------------|-------------------------------------|------|--------------------------|-------------------------|-------------------------|--------------------------|
| | AC (RMS) | DC | | | | |
| M | 400 | 500 | 1300 VRMS | 550 VRMS | 350 VRMS | 200 VRMS |
| N | 300 | 450 | 1000 VRMS | 400 VRMS | 260 VRMS | 200 VRMS |
| I | 600 | 850 | 1800 VRMS | 600 VRMS | 400 VRMS | 200 VRMS |
| II | 900 | 1250 | 2300 VRMS | 800 VRMS | 500 VRMS | 200 VRMS |

**Please note that the establishment of electrical safety factors is left entirely in the designer's hands, since he is in the best position to know what peak voltage, switching surges, transients, etc. can be expected in a particular circuit.

MIL-DTL-38999 Series III STANDARD 500 CYCLE CONTACTS FOR TV AND CTV, P & S

| Contact Size | TV/CTV Pins | | TV/CTV Sockets | |
|--------------|-----------------|-------------|----------------|-------------|
| | Military No. | Supersedes | Military No. | Supersedes |
| 8 (Coax)* | M39029/60-367 | MS27536 | M39029/59-366 | MS27535 |
| 8 (Power) | Contact Factory | " | " | " |
| 8 (Twinax) | M39029/90-529** | N/A | M39029/91-530 | N/A |
| 10 (Power) | M39029/58-528 | N/A | M39029/56-527 | N/A |
| 12 | M39029/58-365 | MS27493-12 | M39029/56-353 | MS27490-12 |
| 16 | M39029/58-364 | MS27493-16 | M39029/56-352 | MS27490-16 |
| 20 | M39029/58-363 | MS27493-20 | M39029/56-351 | MS27490-20 |
| 22D | M39029/58-360 | MS27493-22D | M39029/56-348 | MS27490-22D |
| 4 | N/A | N/A | N/A | N/A |
| 0 | N/A | N/A | N/A | N/A |

** For use with M17/M176-00002 cable.

† Optional design - see slash sheet MS39029.

For other contact options available for use in Tri-Start connectors, (wire wrap, thermocouple, fiber optic) consult Amphenol. Wire wrap data given on next page.

Above part numbers include standard 500 cycle finish designation - gold plating over suitable underplate in accordance with SAE AS39029. For other finish variations, consult Sidney, NY.

*For use with RG180B/U and RG195A/U cable. For other size 8 coax or optional sizes 12 and 16 coax contacts available for use in Tri-Start connectors, see High Speed Contact section of this catalog or consult Amphenol, Sidney, NY.

MIL-DTL-38999 Series III 1500 CYCLE CONTACTS FOR CTV, CLASSES H & J

| Contact Size | CTV Pins | | | CTV Sockets | | |
|--------------|----------------|----------------|------------|----------------|----------------|------------|
| | Commercial No. | Military No. | Supersedes | Commercial No. | Military No. | Supersedes |
| 12 | 10-597072-2X | M39029/107-623 | - | 10-597073-2X | M39029/106-617 | - |
| 16 | 10-597068-2X | M39029/107-622 | - | 10-597069-2X | M39029/106-616 | - |
| 20 | 10-597064-2X | M39029/107-621 | - | 10-597065-2X | M39029/106-615 | - |
| 22D | 10-597058-3X | M39029/107-620 | - | 10-597061-2X | M39029/106-614 | - |

MIL-DTL-38999 Series II JT/ Series I LJT CRIMP CONTACTS

| Contact Size | JT/LJT Pins | JT Socket | LJT Sockets | Contact Size | JT/LJT Pins | JT Socket | LJT Sockets |
|--------------|-----------------|---------------|---------------|--------------|---------------|---------------|---------------|
| | MS No. | MS No. | MS No. | | MS No. | MS No. | MS No. |
| 8 (Coax)* | M39029/60-367 | NA | M39029/59-366 | 20 | M39029/58-363 | M39029/57-357 | M39029/56-351 |
| 8 (Twinax) | M39029/90-529** | NA | M39029/91-530 | 22 | M39029/58-362 | M39029/57-356 | M39029/56-350 |
| 10 (Power) | M39029/58-528 | NA | M39029/56-527 | 22M | M39029/58-361 | M39029/57-355 | M39029/56-349 |
| 12 | M39029/58-365 | M39029/57-359 | M39029/56-353 | 22D | M39029/58-360 | M39029/57-354 | M39029/56-348 |
| 16 | M39029/58-364 | M39029/57-358 | M39029/56-352 | | | | |

III
II
I
SJT
38999

26482
Matrix 2

83723 III
Matrix
Pyle

5015
Crimp Rear
Release Matrix

26500 Pyle

Printed
Circuit Board

EMI Filter
Transient

Fiber Optics

High Speed
Contacts

Options
Others

FINISH DATA MIL-DTL-38999, Tri-Start Series III TV

| Aluminum Shell Components Non-Hermetic | | |
|--|---------------|------------|
| Finish | Service Class | |
| | Military | Commercial |
| Anodic Coating (Non-Conductive) | C | RX** |
| Electroless Nickel | F (Metal) | RF |
| | M (Composite) | |
| Olive Drab Cadmium Plate Nickel Base | W (Metal) | RW |
| | J (Composite) | |
| Stainless Steel with Nickel Plate | S | RS |
| Stainless Steel | K | RK |
| Duralon plated | T | DT |
| Zinc-Nickel Plated | Z | ZN |

| Hermetic Shell Components | | |
|-----------------------------------|---------------|------------|
| Material/Finish | Service Class | |
| | Military | Commercial |
| Stainless Steel | Y | Y |
| Stainless Steel with Nickel Plate | N | YN |

**Add Suffix (005) to part number.

FINISH DATA MIL-DTL-38999, Series I LJT, II JT

| Aluminum Shell Components Non-Hermetic | | | | | |
|--|----------|------------|-------------------------|---|--|
| Finish | Suffix | | | Indicated Finish Standard for JT Types Listed Below | Indicated Finish Standard for LJT Types Listed Below |
| | Military | Commercial | Finish Plus "SR" Suffix | | |
| Cadmium Plated Nickel Base | MS (A) | - | (SR) | JT/JTG/JTL/JTP | LJT/LJTP |
| Anodic Coating (Alumilite) | MS (C) | (005) | (300) | JTS/JTPS/JTLS | LJTPS/LJTS |
| Chromate Treated (Iridite 14-2) | | (011) | (344) | JTN/JTPN/JTLN | LJTN/LJTPN |
| Olive Drab Cadmium Plate Nickel Base | MS (B) | (014) | (386) | | |
| Electroless Nickel | MS (F) | (023) | (424) | | |
| Nickel-PTFE | | (038) | | | |

| Hermetic Connectors | | | | |
|--|----------|------------|---|--|
| Finish | Suffix | | Indicated Finish Standard for JT Types Listed Below | Indicated Finish Standard for LJT Types Listed Below |
| | Military | Commercial | | |
| Carbon Steel Shell Tin Plated Shell and Contacts | | | JT()H / JT()Y JTL()H / JTL()Y | LJT()Y LJT()H |
| Carbon Steel Shell Tin Plated Shell and Gold Plated Contacts | MS (D) | | | |
| Stainless Steel Shell Gold Plated Contacts | MS (E) | (162) | JTS()Y JTLS()Y | LJTS()Y |

38999
SJT I II III

26482
Matrix 2

83723 III
Matrix Pyle

5015
Crimp Rear Release Matrix

26500 Pyle

Printed
Circuit Board

EMI Filter
Transient

Fiber Optics

High Speed
Contacts

Options
Others

Amphenol MIL-DTL-38999, Series III, TV



**New
Featured**



**New
Featured**



TABLE OF CONTENTS

Combined MIL-DTL-38999 Series I, II, III

- Shell Size & Insert Arrangements Availability 4 -7
- Insert Arrangement Drawings 8-14
- Specifications - Contact Ratings, Service Ratings, Finish Data 15, 16

MIL-DTL-38999, Series III TV

- Table of Contents 17
- Performance, Options 18, 19
- Weight Comparison (Composite vs. Metal) 20
- Test Data 21
- How to Order (Commercial & Military) 22-24
- How to Order (Boeing BACC63) 25

Shell Styles:

- Crimp Wall Mounting Receptacle TVP00R (D389999/20) /CTVP00R (D38999/20) 26
- Crimp Box Mounting Receptacle TVP02R / CTVP02R 27
- Crimp Straight Plug TV06R (D38999/26) / CTV06R (D38999/26) 28
- Crimp CLUTCH-LOK™ Straight Plug for High Vibration TV26/MTV26 29
- Crimp Jam Nut Receptacle TV07R (D38999/24) / CTV07R (D38999/24) 30
- Crimp Line Receptacle TV01R / CTV01R 31
- Crimp Flange Mounting Plug TV09R 32
- Hermetic Box Mounting Receptacle TVPS02Y (D38999/21) 33
- Hermetic Jam Nut Receptacle TVS07Y (D38999/23) 34
- Hermetic Solder Mounting Receptacle TVSIY (D38999/25),
Hermetic Weld Mounting Receptacle TVSHIY (D38999/27) 35
- Breakaway Fail-Safe Lanyard Release Plug
D38999/29 & /30 (88-5565 / 91-5565) 36, 37
- Breakaway Fail-Safe How to Order (Military/Commercial) 38, 39
- Breakaway MIL-STD-1760 Lanyard Release Plug D38999/31 40
- Breakaway MIL-STD-1760 How to Order (Military) 41
- Breakaway Hybrid, Low Profile Lanyard Release Plug 42
- Stores Management Type II, Rail Launch (MIL-STD-1760) 42
- HD38999 (High Density, Crimp) Plugs and Receptacles / How to Order . . 43, 44
- Accessories, Contacts, and Tools see pages 89-108



MIL-DTL-38999 Series III Typical Markets:

- Military & Commercial Aviation
- Military Vehicles
- Missiles & Ordnance
- C4ISR
- Space Applications



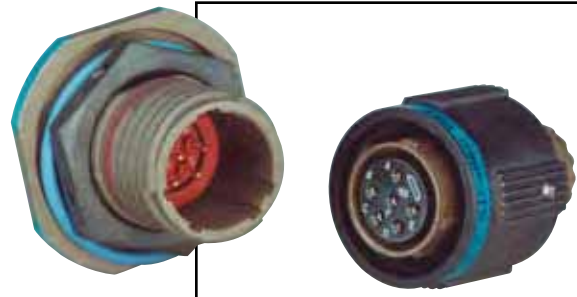

Tri-Start™ MIL-DTL-38999 Series III

with Metal Shells - Aluminum, Stainless Steel, Class K Firewall

Amphenol® Tri-Start MIL-DTL-38999* Series III Connectors offer the highest performance capabilities for both general duty and severe environment applications. Meeting or exceeding MIL-DTL-38999 Series III requirements, the Tri-Start connector with standard metal shells (aluminum or stainless steel with several finish options) offers these features:

- **EMI Shielding** - solid metal to metal coupling, grounding fingers, electroless nickel plating, and thicker wall sections provide superior EMI shielding capability of 65dB minimum at 10 GHz
- **Contact Protection** - recessed pins in this 100% scoop-proof connector minimize potential contact damage
- **Moisture Resistance** - improved interfacial seal design helps prevent electrolytic erosion of contacts
- **Corrosion Resistance** - shells of stainless steel or cadmium over nickel plating withstand a 500 hour salt spray exposure
- **Vibration/Shock** - operates under severe high temperature vibration, through 200°C
- **Firewall Capability** - available in a stainless steel shell, class RK, RS
- **Lockwiring Eliminated** - unique, self-locking, quick coupling connector eliminates lockwiring
- **Quick Coupling** - completely mates and self-locks in a 360° turn of the coupling nut
- **Inventory Support Commonality** - uses standard MIL-DTL-38999 contacts, application tools, insert arrangements
- **Electrostatic Discharge Protection (ESD)** - protection for sensitive circuitry without diodes, varistors, etc., with the use of the Faraday Cage principle which shunts high voltage, high current discharge events (see page 422)
- **Hermetic** - air leakage limited to $1 \times 10^{-7} \text{ cm}^3$ per second optional
- **Qualified Specifications** - Stainless Steel qualified to BACC63DB and BACC63DC specifications

Optional Shell Geometries

Amphenol offers a number of different shell configurations to fit your needs.

- Deep Reach Shells - For increased panel thickness
- Stand-off Flange Shells - For attachments to Printed Circuit boards.
- Connector with Integral Strain Reliefs

* MIL-DTL-38999 Series III supersedes MIL-C-38999 Series III.

Applicable Patents:
 Tri-Start™ Connector Patent 4,109,990.
 Composite Connector Patents:
 4,268,103; 4,648,670; 4,682,832; 4,703,987.
 Clutch-Lok® Patent 6,152,753.



Series III

Composite Tri-Start,
 Qualified to MIL-DTL-38999, Rev. J

MIL-Qualified to MIL-DTL-38999, Rev. K, the Amphenol® Composite Tri-Start Connector offers a lightweight, corrosion resistant connector with the same high performance features as its metal counterpart. The Composite Tri-Start Connector also includes the following features:

- **Lightweight** - 17% – 70% weight savings (17–40% weight savings vs. Aluminum) (60–70% weight savings vs. Stainless steel) See Composite weight comparison chart on page 20.
- **Corrosion Resistance** - available in standard MIL-DTL-38999 olive drab cadmium (-65°C to 175°C) and electroless nickel plating (-65°C to 200°C), both with standing 2000 hours of salt spray exposure. The base material is able to withstand an indefinite exposure to salt spray.
- **Durability** - 1500 couplings minimum (in reference to connector couplings, not contacts)
- **Extended Life Contact** - Mil-approved plating process which provides 1500 couplings minimum
- Qualified to BACC63CT and BACC63CU specifications



CLUTCH-LOK™ MIL-DTL-38999 Series III High Vibration Connector

The Tri-Start option CLUTCH-LOK offers all advantages of stainless steel/Class K firewall for MIL-DTL-38999 Series III connectors, plus a unique clutch design that actually tightens itself under vibration.

Features include:

- High degree of differential torque
 - No settling back to the next ratchet tooth
 - Completely intermateable with all existing MIL-DTL-38999 Series III connectors
 - Offers advantage in inaccessible, hard to reach areas where mating torque is difficult to apply and complete coupling is not verifiable by inspection
- See page 29 for description, 22 – 24 for ordering.

38999
SJT I II III

26482
Matrix 2

83723 III
Matrix Pyle

5015
Crimp Rear Release Matrix

26500 Pyle

Printed
Circuit Board

EMI Filter
Transient

Fiber Optics

High Speed
Contacts

Options
Others

Series III, TV Tri-Start Connectors, offer more versatility & options than any other interconnection family!



High reliability and increased versatility best describe Amphenol MIL-DTL-38999, Series III circular connectors. Originally designed for the harshest of environments and most demanding of applications, Amphenol MIL-DTL-38999 Series III, Tri-Start connectors continue to evolve in pace with the needs of an ever-changing market.

Amphenol Tri-Start connectors can be configured with a number of application specific technologies like Filters, Hermetics, PC Tails, Fiber Optics, Flex, CLUTCH-LOK, Fail Safe, and contacts. Flexibility aids in design optimization through the combination of different technologies within a common, time-tested, harsh environment connector body.

For more information about options please call 800-678-0141 or visit www.amphenol-aerospace.com.

Performance

Designed for Performance

Numerous advantages in performance capability are designed into the Amphenol Tri-Start Connector. A positive metal to metal coupling design, grounding fingers, and electroless nickel plating provide superior EMI shielding capability of 65 dB minimum at 10 GHz.

Acme threads provide coupling durability. Thicker wall sections and a greater coupling surface area improve strength and shock resistance. Blunting of the thread on both the coupling nut and receptacle eliminates cross coupling. The connector quickly mates and self locks in a 360° turn of the coupling nut.

Elongated mounting holes permit the Tri-Start Connector to intermount with various existing MIL-Spec box or wall mount receptacles, giving it a design replacement advantage.

Shells of stainless steel, or cadmium over nickel plating prevent severe corrosion. Resistance is tested through exposure to a 500 hour salt spray. Composite versions provide protection from salt spray exposure for 2000 hours. Other finish options are available; see how to order Tri-Start metal and Tri-Start Composite.

Recessed pins minimize potential contact damage in this 100% scoop-proof connector. In a blind mating application, mating shells cannot “scoop” the pins and cause a shorting or bending of contacts.

The design of the Amphenol Tri-Start interfacial seal meets the MIL-DTL-38999 Series III requirements for electrolytic erosion resistance.

A rigid dielectric insert with excellent electrical characteristics provides durable protection to the contacts. The socket contacts are probe proof, and all contacts are rear removable. They are plated in the standard 50 micro inches minimum gold, with 100 micro inches as an option, and are available in standard Tri-Start insert arrangements and special Pyle® insert arrangements in sizes 10 power, 12, 16, 20 and 22D contacts. Special insert patterns are also available with larger contacts in sizes 4 and 0.

III
38999
II
I
SJT

26482
Matrix 2

83723 III
Matrix
Pyle

5015
Crimp Rear
Release Matrix

26500 Pyle

Printed
Circuit Board

EMI Filter
Transient

Fiber Optics

High Speed
Contacts

Options
Others

Depending on the shell style, shell size and contact count, weight savings can range from 17% to 40% compared to standard aluminum product

Tri-Start Weight in Ounces (includes contacts)

Weight

| | Wall Mount Receptacle (00 • Military D38999/20) | | | | | | Jam Nut Receptacle (07) • Military D38999/24 | | | | | | Plug (06) • Military D38999/26 | | | | | |
|-------|---|--------|----------|--------|-----------|--------|--|--------|----------|--------|-----------|--------|--------------------------------|--------|----------|--------|-----------|--------|
| | Stainless Steel | | Aluminum | | Composite | | Stainless Steel | | Aluminum | | Composite | | Stainless Steel | | Aluminum | | Composite | |
| | Pin | Socket | Pin | Socket | Pin | Socket | Pin | Socket | Pin | Socket | Pin | Socket | Pin | Socket | Pin | Socket | Pin | Socket |
| 9-35 | .7216 | .7840 | .3248 | .3777 | .2588 | .3121 | 1.1472 | 1.2096 | .4416 | .5040 | .3489 | .4413 | 1.0736 | 1.1360 | .4236 | .4625 | .2606 | .2994 |
| 9-98 | .7216 | .7776 | .2496 | .3056 | .1664 | .2224 | 1.1472 | 1.2032 | .4416 | .4976 | .3744 | .4640 | 1.0736 | 1.1296 | .3968 | .4624 | .2991 | .2337 |
| 11-35 | .9488 | 1.0800 | .3632 | .4960 | .2753 | .4081 | 1.4304 | 1.5632 | .5936 | .7264 | .4679 | .6007 | 1.2480 | 1.3808 | .5312 | .6389 | .3450 | .4582 |
| 11-98 | .9488 | 1.0620 | .3632 | .4768 | .2753 | .3889 | 1.4304 | 1.5440 | .5936 | .7072 | .4679 | .5815 | 1.2480 | 1.3616 | .5330 | .6283 | .3468 | .4457 |
| 13-8 | 1.2096 | 1.3888 | .4800 | .6592 | .3696 | .5488 | 1.9104 | 2.0896 | .7664 | .9456 | .6560 | .8352 | 1.8048 | 1.9840 | .7936 | .9728 | .5237 | .5952 |
| 13-35 | 1.2160 | 1.4320 | .4864 | .7024 | .3762 | .5922 | 1.9168 | 2.1328 | .7728 | .9888 | .6136 | .8296 | 1.8112 | 2.0272 | .8000 | .8472 | .5301 | .6531 |
| 13-98 | 1.2160 | 1.4016 | .4864 | .6720 | .3762 | .5618 | 1.9168 | 2.1024 | .7728 | .9584 | .6136 | .7992 | 1.8112 | 1.9968 | .7978 | .9856 | .5244 | .7157 |
| 15-5 | 1.5312 | 1.7904 | .6352 | .8944 | .5027 | .7619 | 2.3792 | 2.6384 | .9728 | 1.2320 | .7749 | 1.0341 | 2.2704 | 2.5456 | .9632 | 1.1719 | .6450 | .8467 |
| 15-18 | 1.5456 | 1.8416 | .7760 | .9456 | .6432 | .8128 | 2.3936 | 2.6896 | .9872 | 1.2832 | .8544 | 1.1504 | 2.2848 | 2.5808 | .9776 | 1.2736 | .6594 | .8208 |
| 15-35 | 1.5424 | 1.8768 | .6464 | .9808 | .5139 | .8483 | 2.3904 | 2.7344 | .9840 | 1.3280 | .7861 | 1.1301 | 2.2816 | 2.6256 | 1.2179 | 1.3184 | .8961 | 1.0002 |
| 17-6 | 2.1488 | 2.5904 | .9360 | 1.3776 | .7812 | 1.2228 | 2.9152 | 3.3568 | 1.2336 | 1.6752 | .9940 | 1.4356 | 2.5008 | 3.1024 | 1.1408 | 1.7424 | .8160 | 1.4176 |
| 17-26 | 2.1344 | 2.5600 | .9216 | 1.3472 | .7668 | 1.1924 | 2.9008 | 3.3264 | 1.2192 | 1.6448 | .9796 | 1.4052 | 2.4864 | 2.9120 | 1.1264 | 1.3343 | .8017 | .8062 |
| 17-35 | 2.1360 | 2.6640 | .9232 | 1.4512 | .7684 | 1.2964 | 2.9024 | 3.4304 | 1.2208 | 1.7488 | .9812 | 1.5092 | 2.4880 | 3.0160 | 1.1280 | 1.5497 | .8033 | 1.2144 |
| 19-11 | 2.2592 | 2.6656 | .9696 | 1.4528 | .7925 | 1.2757 | 3.4352 | 3.9184 | 1.4720 | 1.9552 | 1.2033 | 1.6865 | 2.9808 | 3.4640 | 1.3472 | 1.8304 | .9632 | 1.4464 |
| 19-32 | 2.1888 | 2.7264 | .9760 | 1.5136 | .7989 | 1.3365 | 3.4416 | 3.9792 | 1.4784 | 2.0160 | 1.2097 | 1.7473 | 2.9872 | 3.5248 | 1.3536 | 1.8912 | .9696 | 1.5072 |
| 19-35 | 2.1920 | 2.8432 | .9792 | 1.6304 | .8021 | 1.4533 | 3.4448 | 4.0960 | 1.4816 | 2.1328 | 1.2129 | 1.8641 | 2.9904 | 3.6416 | 1.3568 | 2.0080 | .9728 | 1.6240 |
| 21-11 | 2.7456 | 3.4640 | 1.3088 | 2.0272 | 1.1088 | 1.8272 | 3.9712 | 4.6896 | 1.8128 | 2.5312 | 1.6128 | 2.3312 | 3.4448 | 4.1632 | 1.7344 | 2.5312 | 1.3039 | 1.8710 |
| 21-16 | 2.6784 | 3.3168 | 1.2416 | 1.8800 | 1.0422 | 1.6806 | 3.9040 | 4.5424 | 1.7456 | 2.3840 | 1.4505 | 2.0889 | 3.3776 | 4.0160 | 1.6672 | 2.3168 | 1.2352 | 1.8736 |
| 21-35 | 2.6672 | 3.4992 | 1.2304 | 2.0624 | 1.0310 | 1.8630 | 3.8928 | 4.7248 | 1.7344 | 2.5664 | 1.4393 | 2.2713 | 3.3664 | 4.1984 | 1.6560 | 2.2309 | 1.2255 | 1.8003 |
| 21-41 | 2.6768 | 3.3600 | 1.2400 | 1.9232 | 1.0406 | 1.7238 | 3.9024 | 4.5856 | 1.7440 | 2.4272 | 1.4489 | 2.1321 | 3.3760 | 3.5792 | 1.6656 | 1.8688 | 1.2336 | 1.4368 |
| 23-21 | 3.0352 | 3.8624 | 1.4496 | 2.2768 | 1.2279 | 2.0551 | 4.2368 | 5.0640 | 1.9440 | 2.7712 | 1.6368 | 2.4640 | 3.7920 | 4.6192 | 1.9216 | 2.7488 | 1.4637 | 2.2896 |
| 23-35 | 3.0240 | 4.0448 | 1.4384 | 2.4592 | 1.2167 | 2.2375 | 4.2256 | 5.2464 | 1.9328 | 2.9536 | 1.6256 | 2.6464 | 3.7808 | 4.8016 | 1.9104 | 2.6087 | 1.4525 | 2.1507 |
| 23-53 | 2.8992 | 3.9072 | 1.4560 | 2.4816 | 1.2343 | 2.2599 | 4.2432 | 5.1088 | 1.9504 | 2.8160 | 1.6432 | 2.5088 | 3.7984 | 4.6640 | 1.9280 | 2.7936 | 1.4672 | 2.2384 |
| 25-4 | 3.4512 | 4.4800 | 1.7312 | 2.8816 | 1.4864 | 2.1904 | 4.8048 | 5.8272 | 2.2016 | 3.2480 | 1.9568 | 2.8720 | 4.2224 | 5.2496 | 2.2128 | 3.2560 | 1.7133 | 2.4163 |
| 25-19 | 3.5312 | 4.7264 | 1.8112 | 3.0064 | 1.5664 | 2.7616 | 4.8848 | 6.0816 | 2.2816 | 3.4784 | 2.0368 | 3.2336 | 4.3024 | 5.4992 | 2.2928 | 3.4896 | 1.7933 | 2.7058 |
| 25-20 | 3.8190 | 4.7150 | 2.0173 | 3.1125 | 1.7733 | 2.8512 | 5.1430 | 6.0380 | 2.4877 | 3.5421 | 2.1872 | 3.2416 | 4.4350 | 5.3300 | 2.2580 | 3.0182 | 1.8288 | 2.8928 |
| 25-35 | 3.4416 | 4.6656 | 1.7216 | 2.9456 | 1.4776 | 2.7016 | 4.7952 | 6.0192 | 2.1920 | 3.4160 | 1.8915 | 3.1155 | 4.2128 | 5.4368 | 2.2032 | 3.4272 | 1.7037 | 2.9277 |
| 25-61 | 3.4304 | 4.4848 | 1.7282 | 2.7648 | 1.4841 | 2.5208 | 4.7840 | 5.8384 | 2.1808 | 3.2352 | 1.8803 | 2.9347 | 4.2016 | 5.2560 | 2.1920 | 3.2464 | 1.6912 | 2.7456 |

All weight measurements are for reference only.

- 38999 III
- SJT I II
- 26482 Matrix 2
- 83723 III Pyle Matrix
- 5015 Crimp Rear Release Matrix
- 26500 Pyle
- Printed Circuit Board
- EMI Filter Transient
- Fiber Optics
- High Speed Contacts
- Options Others

TRI-START, SERIES III TYPICAL SHIELDING EFFECTIVENESS TEST DATA

EMI/EMP SHIELDING EFFECTIVENESS dB
TESTING BY TRIAXIAL METHOD



TRI-START, SERIES III TYPICAL SHIELDING EFFECTIVENESS TEST DATA

EMI/EMP SHIELDING EFFECTIVENESS dB
TESTING BY MODE STIRRING METHOD



Amphenol® Tri-Start connectors provide EMI/EMP shielding capability which exceeds MIL-DTL-38999 Series III requirements.

The TV and CTV Series III connector with standard solid metal to metal coupling, EMI grounding fingers and conductive finishes has proven to be the ultimate in EMI/EMP shielding effectiveness. The charts illustrate shielding effectiveness data which is typical of Tri-Start connectors tested with the nickel finish (Class F-metal, Class M-composite) over a wide frequency range.

The vibration capability of the Tri-Start Series is shown in the chart below. This illustrates the most severe vibration envelope of *any* qualified connector available today.

These capabilities along with a +200°C, -65°C temperature rating and superior moisture sealing protection provide the user with a connector that can withstand the most rigorous application.

TRI-START VIBRATION CRITERIA

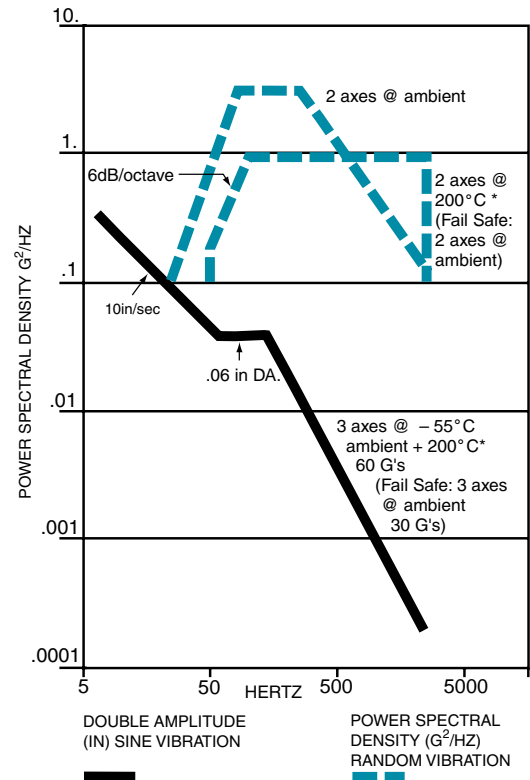

* Dependant on shell finish

Test data beyond 2GHz is subject to equipment variation.

NOTE: For test data information on the new Clutch-Lok Tri-Start, high vibration connectors, consult Amphenol Aerospace.

| | |
|---------------------------|---------------------|
| III | 38999 |
| II | |
| I | |
| SJT | |
| Matrix 2 | 26482 |
| Matrix | 83723 III |
| Pyle | |
| Crimp Rear Release Matrix | 5015 |
| | 26500 Pyle |
| Circuit Board | Printed |
| Transient | EMI Filter |
| | Fiber Optics |
| | High Speed Contacts |
| | Options Others |

Easy Steps to build a part number... Tri-Start Series III TV

| 1. | 2. | 3. | 4. | 5. | 6. | 7. |
|------------|-------------|---------------|--------------------------------|--------------|---------------------------|--------------------|
| Commercial | Shell Style | Service Class | Shell Size– Insert Arrangement | Contact Type | Alternate Keying Position | Special Variations |
| TVPS | 00 | RF | 9-35 | P | B | (XXX) |
| Military | Shell Style | Service Class | Shell Size– Insert Arrangement | Contact Type | Alternate Keying Position | |
| D38999/ | 20 | J | G35 | P | N | |

Step 1. Select a Connector Type

Step 2. Select a Shell Style

| | Designates |
|---------------|--|
| TV | Tri-Start Series Connector |
| TVP | Back panel mounted receptacle |
| TVS | 200° C rated |
| TVPS | Panel mounted, 200°C rated receptacle |
| MTV | CLUTCH-LOK connector with "MS" stamping (Note: remove dashes in how to order part number when ordering CLUTCH-LOK) |
| CTV | Composite MIL-DTL-38999 Series III Connector |
| CTVP | Panel mounted composite receptacle |
| CTVS | 200° C rated, composite |
| CTVPS | Composite Panel mounted, 200° rated receptacle |
| D38999 | Military MIL-DTL-38999 Series III Connector |

| COMMERCIAL | | | | MILITARY | | | Designates | |
|------------------------|---------|-----|------|------------|-----------------|---------------------------|------------|--|
| TVP, TVPS, CTVP, CTVPS | TV, CTV | TVS | CTVS | CLUTCH-LOK | D38999 Military | D38999 Military Composite | | MTV, D38999 CLUTCH-LOK |
| 00 | | | | | 20 | 20 | | Wall Mount Receptacle |
| 02 | | | | | | | | Box Mount Receptacle |
| | | | | | 21 | | | Box Mount Receptacle Hermetic |
| | 01 | 01 | 01 | | | | | Line Receptacle |
| | 06 | 06 | 06 | | 26 | 26 | | Straight Plug |
| | 07 | 07 | 07 | | 24 | 24 | | Jam Nut Receptacle |
| | 09 | 09 | | | | | | Flange Mounted Plug |
| | | | | | 23 | | | Jam Nut Receptacle Hermetic |
| | | I | | | 25 | | | Solder Mount Receptacle Hermetic |
| | | HI | | | 27 | | | Weld Mounted Receptacle, (Hermetic) Only |
| | | | | 26 | | | 26 | CLUTCH-LOK high vibration straight plug (service Classes RK & RS only) |
| | | | | | 29 | | | Lanyard release plug with pin contacts |
| | | | | | 30 | | | Lanyard release plug with socket contacts |
| | | | | | 31 | | | Lanyard release plug for MIL-STD-1760 with pin contacts |
| | | | | | 32 | | | Plug protection cap |
| | | | | | 33 | | | Receptacle protection cap |



Wall Mount Receptacle



Line Receptacle



Box Mount Receptacle



Straight Plug



Jam Nut Receptacle



Flange Mounting Plug



Deep Reach Receptacle



Solder Mount Hermetic Receptacle



Lanyard Release Plug

- 38999 III
- SJT I II
- 26482 Matrix 2
- 83723 III Pyle Matrix
- 5015 Crimp Rear Release Matrix
- 26500 Pyle
- Printed Circuit Board
- EMI Filter Transient
- Fiber Optics
- High Speed Contacts
- Options Others

MIL-DTL-38999, Series III TV

How to Order (Military and Commercial)



Step 3. Select a Service Class

| 1. Connector Type | 2. Shell Style | 3. Service Class | 4. Shell Size-Insert Arrg. | 5. Contact Type | 6. Alternate Position | 7. Special Variations |
|-------------------|----------------|------------------|----------------------------|-----------------|-----------------------|-----------------------|
| | | RX | | | | |

| TV, TVP | CTV, CTVP | CTVS, CTVPS | TVS | TVPS | CLUTCH-LOK | Military | Finish | Description |
|------------------|----------------------|----------------------|------------------|-----------------|-------------|--------------------------------------|---------------------------------|--|
| | | | RX | | | C | Anodic Coating | Alternate finish, Non-conductive, anodic coated aluminum, 500 hour salt spray, 200°C. Consult Amphenol, Sidney NY for details, options and availability of non-cadmium or nickel finishes. |
| | | RF-Composite | RF-Metal | RF-Metal | | F-Metal M-Composite | Electroless Nickel | electroless nickel plated aluminum (composite) optimum EMI shielding effectiveness-65dB @ 10GHz specification min., 48 hour salt spray, 200°C (Composite-2000 hours dynamic salt spray). |
| | | RGF-Composite | RGF-Metal | | | | Electroless Nickel | electroless nickel plated ground plane aluminum (composite), 200°C |
| | | | | | | G | Electroless Nickel | Space grade, electroless nickel, 48 hour salt spray, 200°C |
| RGW-Metal | RGW-Composite | | | | | | Olive Drab Cadmium | Olive drab cadmium plated ground plane aluminum (composite), 175°C |
| | | | RK** | RK** | RK** | K | Passivated Stainless Steel | Corrosion resistant stainless steel, firewall capability, plus 500 hour salt spray resistance, EMI -45 dB @ 10 GHz specification min., 200°C |
| | | | RL | RL | | L | Stainless Steel w/ Nickel Plate | Corrosion resistant steel, electro deposited nickel, 500 hour salt spray, 200°C, non firewall |
| RW-Metal | RW-Composite | | | | | W-Metal J-Composite | Olive Drab Cadmium | Corrosion resistant olive drab cadmium plate aluminum (composite), 500 hour salt spray, EMI -50 dB @ 10 GHz specification min., 175°C (Composite-2000 hours dynamic salt spray). |
| | | | Y | Y | | Y | Stainless Steel | Hermetic seal, passivated stainless steel, 200°C |
| | | | RS* | RS* | RS* | S | Stainless Steel w/ Nickel Plate | (Non-hermetic connectors), Nickel plated, corrosion resistant steel, firewall capability, 500 hour salt spray, 200° |
| | | | YN | YN | | N | Stainless Steel w/ Nickel Plate | (Hermetic connectors), Nickel plated corrosion resistant steel, 200°C |
| DT | | | | | | T | Durmalon plated | Nickel-PTFE alternative to Cadmium. Corrosion resistant, 500 hour salt spray, EMI-50dB at 10GHz specification min., 175°C |
| ZN | | | | | | Z | Zinc-Nickel Plated | Zinc-Nickel Alternative to Cadmium corrosion resistant, 500 hour salt spray, Conductive, -65°C to +175°C |

Quadrax or Differential Twinax: * Consult Amphenol Aerospace, Sidney, NY for availability. **Coaxial arrangements are not available in these classes.

The incorporation of Quadrax or Differential Twinax contacts requires a modified connector to accommodate keyed contacts.
 * D38999/26KJ20PN, is a series III stainless steel plug with twin axial and coaxial contacts that may not meet the firewall requirement of the specification.
 D38999/26KJ61HN, is a series III stainless steel plug with high durability contacts. However, the connector will be limited to 500 cycles of durability.
 Insert arrangements using multi-axial (i.e. coax, twinax, triax shielded) contacts should not be used in firewall applications.

Step 4. Select a Shell Size & Insert

Arrangement see pg. 4-7

Shell Size & Insert Arrangement are on pages 4-7. First number represents Shell Size, second number is the Insert Arrangement.

| 1. Connector Type | 2. Shell Style | 3. Service Class | 4. Shell Size-Insert Arrg. | 5. Contact Type | 6. Alternate Position | 7. Special Variations |
|-------------------|----------------|------------------|----------------------------|-----------------|-----------------------|-----------------------|
| | | | 22-2 | P | | |

Step 5. Select a Contact Type

| Designates | |
|------------|--|
| P | Pin Contacts |
| S | Socket Contacts |
| H | 1500 Cycle Pin Contacts |
| J | 1500 Cycle Socket Contacts |
| A | Same as "P" except supplied less pin Contacts (For Military D38999 prefix only) |
| B | Same as "S" except supplied less socket contacts (A & B designate nonstandard contact applications) (For Military D38999 prefix only) |
| X | Eyelet contacts, hermetics only |

- III
- 38999
- II
- I
- SJT
- 26482
- Matrix 2
- 83723 III
- Matrix
- Pyle
- 5015
- Crimp Rear
- Release Matrix
- 26500 Pyle
- Printed
- Circuit Board
- EMI Filter
- Transient
- Fiber Optics
- High Speed
- Contacts
- Options
- Others

38999 III
SJT I II

26482 Matrix 2

83723 III Pyle Matrix

5015 Crimp Rear Release Matrix

26500 Pyle

Printed Circuit Board

EMI Filter Transient

Fiber Optics

High Speed Contacts

Options Others

Step 6. Select an Alternate Keying Position

Key/Keyway Position

| Shell Size | Key & Keyway Arrangement Identification Letter | AR° or AP° BSC | BR° or BP° BSC | CR° or CP° BSC | DR° or DP° BSC |
|-----------------|--|----------------|----------------|----------------|----------------|
| 9 | N* | 105 | 140 | 215 | 265 |
| | A | 102 | 132 | 248 | 320 |
| | B | 80 | 118 | 230 | 312 |
| | C | 35 | 140 | 205 | 275 |
| | D | 64 | 155 | 234 | 304 |
| 11, 13, and 15 | N* | 95 | 141 | 208 | 236 |
| | A | 113 | 156 | 182 | 292 |
| | B | 90 | 145 | 195 | 252 |
| | C | 53 | 156 | 220 | 255 |
| | D | 119 | 146 | 176 | 298 |
| 17 and 19 | N* | 51 | 141 | 184 | 242 |
| | A | 80 | 142 | 196 | 293 |
| | B | 135 | 170 | 200 | 310 |
| | C | 49 | 169 | 200 | 244 |
| | D | 66 | 140 | 200 | 257 |
| 21, 23, and 25 | N* | 62 | 145 | 180 | 280 |
| | A | 79 | 153 | 197 | 272 |
| | B | 80 | 142 | 196 | 293 |
| | C | 135 | 170 | 200 | 310 |
| | D | 49 | 169 | 200 | 244 |
| 25L, 33, and 37 | N* | 66 | 140 | 188 | 257 |
| | A | 62 | 145 | 188 | 280 |
| | B | 79 | 153 | 197 | 272 |
| | C | 80 | 142 | 188 | 293 |
| | D | 135 | 170 | 188 | 310 |
| | N* | 49 | 169 | 188 | 244 |
| | A | 66 | 140 | 188 | 257 |
| | B | 62 | 145 | 188 | 280 |
| | C | 79 | 153 | 197 | 272 |
| | D | 80 | 142 | 188 | 293 |

* An "N" designation is used on D38999 military part number but not on the commercial versions

| 1. | 2. | 3. | 4. | 5. | 6. | 7. |
|----------------|-------------|---------------|-------------------------|--------------|--------------------|--------------------|
| Connector Type | Shell Style | Service Class | Shell Size-Insert Arrg. | Contact Type | Alternate Position | Special Variations |
| | | | | | B | |

A plug with a given rotation letter will mate with a receptacle with the same rotation letter. The angles for a given connector are the same whether it contains pins or sockets. Master key stay fixed, minor keys rotate. Inserts are not rotated in conjunction with the master key/keyway.

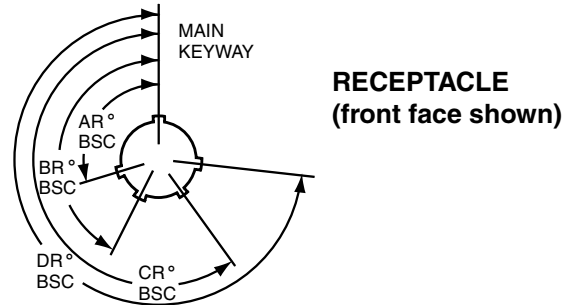

Step 7. Special Variations

Consult Amphenol Aerospace, Sidney NY for variations.

| 1. | 2. | 3. | 4. | 5. | 6. | 7. |
|----------------|-------------|---------------|-------------------------|--------------|--------------------|--------------------|
| Connector Type | Shell Style | Service Class | Shell Size-Insert Arrg. | Contact Type | Alternate Position | Special Variations |
| | | | | | | (xxx) |

Easy Steps to build a part number... Boeing BACC63 CT & CU

1. 2. 3. 4. 5. 6. 7. 8.

| Boeing Basic Number | Style | Shell Size | Shell Finish & Contact | Insert Arrangement | Contact Type | Alternate Keying Position | Ordering Option |
|---------------------|-------|------------|------------------------|--------------------|--------------|---------------------------|-----------------|
| BACC63 | CT | 15 | — | 19 | P | N | H |

Composite

Step 1. Boeing Number BACC63

Step 2. Select a Style

| | Designates |
|----|----------------------|
| CT | Composite Plug |
| CU | Composite Receptacle |

Step 3. Shell Size 15

| | Designates |
|----|----------------|
| 15 | One Shell Size |

Step 4. Select a Shell Finish & Contact

| | Designates |
|---|---|
| C | CT Style Only. Cadmium Plated, Grounded |
| D | Cadmium Plated, ungrounded |
| G | Nickel Plated, Grounded |
| — | Nickel Plated, Ungrounded |

Step 5. Insert Arrangements-
Consult Amphenol Aerospace for insert Arrangements available.

Step 6. Select a Contact Type

| | Designates |
|---|------------|
| P | Pin |
| S | Socket |

Step 7. Select an Alternate Keying Position

| | Designates |
|-----|------------|
| N | Normal |
| A-E | Alternates |

Step 8. Ordering Option

| | Designates |
|-------|-------------------------------|
| H | Without Contacts & Seal Plugs |
| Blank | With contacts and seal plugs |

Easy Steps to build a part number... Boeing BACC63 DB & DC

1. 2. 3. 4. 5. 6. 7. 8.

| Boeing Basic Number | Style | Shell Size | Separator | Insert Arrangement | Contact Type | Alternate Keying Position | Ordering Option |
|---------------------|-------|------------|-----------|--------------------|--------------|---------------------------|-----------------|
| BACC63 | DB | 15 | — | 19 | P | N | H |
| BACC63 | DC | 17 | — | 8 | P | N | H |

Stainless Steel

Step 1. Boeing Number BACC63

Step 2. Select a Style

| | Designates |
|----|----------------------------|
| DB | Stainless Steel Plug |
| DC | Stainless Steel Receptacle |

Step 3. Select a Shell Size

| | Designates |
|------|------------|
| 9-25 | Shell Size |

Step 4. Separator

| | Designates |
|---|------------|
| — | Separator |

Step 5. Insert Arrangements-
Consult Amphenol Aerospace for insert Arrangements available.

Step 7. Select an Alternate Keying Position

| | Designates |
|-----|------------|
| N | Normal |
| A-E | Alternates |

Step 8. Ordering Option

| | Designates |
|-------|-------------------------------|
| H | Without Contacts & Seal Plugs |
| Blank | With contacts and seal plugs |

Step 6. Select a Contact Type

| | Designates |
|---|------------|
| P | Pin |
| S | Socket |

- III 38999 SJT
- Matrix 2 26482
- Matrix Pyle 83723 III
- Crimp Rear Release Matrix 5015
- 26500 Pyle
- Printed Circuit Board
- EMI Filter Transient
- Fiber Optics
- High Speed Contacts
- Options Others

Wall Mounting Receptacle

38999

SJT

26482

Matrix 2

83723 III

Matrix Pyle

5015

Crimp Rear Release Matrix

26500 Pyle

Printed Circuit Board

EMI Filter Transient

Fiber Optics

High Speed Contacts

Options Others

PART

To complete, see how to order pages 22-24.

| Connector Type | Shell Style | Service Class | Shell Size & Insert Arrg | Contact Type | Alternate Position | Special Variations |
|----------------|-------------|---------------|--------------------------|--------------|--------------------|--------------------|
| TVP | 00 | RW | 9-35 | P | B | (453) |
| TVPS | 00 | RK | X-X | X | X | (XXX) |
| TVPS | 00 | RF | X-X | X | X | (XXX) |
| TVPS | 00 | RS | X-X | X | X | (XXX) |
| CTVP | 00 | RW | X-X | X | X | (XXX) |
| CTVPS | 00 | RF | X-X | X | X | (XXX) |
| D38999/ | 20 | X | X-X | X | X | NA |

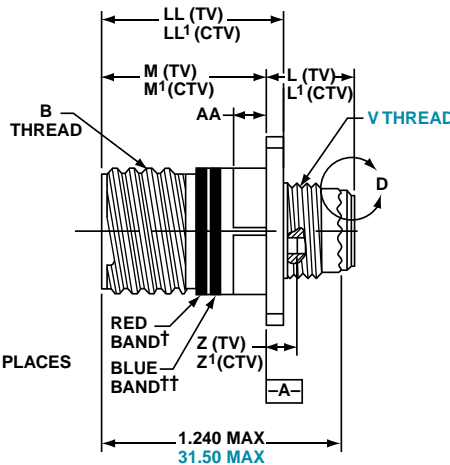
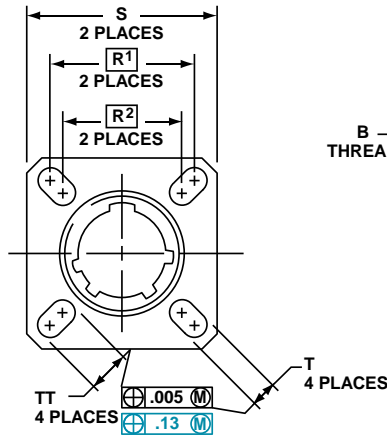

VIEW D FOR SIZE 8 COAXIAL ONLY, RELATIVE TO -A-

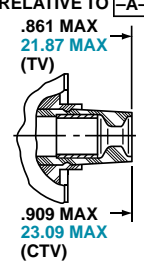

PANEL HOLE DIMENSIONS

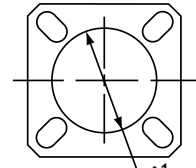

BACK PANEL MOUNTING

VIEW D FOR SIZE 8 TWINAX ONLY, RELATIVE TO -A-

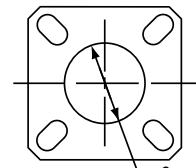
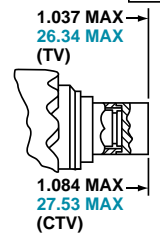

FRONT PANEL MOUNTING

† Red band indicates fully mated

†† Blue band indicates rear release contact retention system

Inches

| Shell Size | MS Shell Size Code | B Thread Class 2A 0.1P=0.3L-TS (Plated) | L Max. (TV) | L' Max. (CTV) | M +.000 - .005 (TV) | M' +.000 - .005 (CTV) | R ¹ | R ² | S Max. | T ±.008 | Z Max. (TV) | Z' Max. (CTV) | A ¹ Back Panel Mount | A ² Front Panel Mount | AA Max. Panel Thickness | LL +.006 - .000 (TV) | LL1 ±.005 (CTV) | TT ±.008 |
|------------|--------------------|---|-------------|---------------|---------------------|-----------------------|----------------|----------------|--------|---------|-------------|---------------|---------------------------------|----------------------------------|-------------------------|----------------------|-----------------|----------|
| 9 | A | .6250 | .469 | .514 | .820 | .773 | .719 | .594 | .948 | .128 | .153 | .198 | .650 | .510 | .234 | .905 | .908 | .216 |
| 11 | B | .7500 | .469 | .514 | .820 | .773 | .812 | .719 | 1.043 | .128 | .153 | .198 | .800 | .620 | .234 | .905 | .908 | .194 |
| 13 | C | .8750 | .469 | .514 | .820 | .773 | .906 | .812 | 1.137 | .128 | .153 | .198 | .910 | .740 | .234 | .905 | .908 | .194 |
| 15 | D | 1.0000 | .469 | .514 | .820 | .773 | .969 | .906 | 1.232 | .128 | .153 | .198 | 1.040 | .900 | .234 | .905 | .908 | .173 |
| 17 | E | 1.1875 | .469 | .514 | .820 | .773 | 1.062 | .969 | 1.323 | .128 | .153 | .198 | 1.210 | 1.010 | .234 | .905 | .908 | .194 |
| 19 | F | 1.2500 | .469 | .514 | .820 | .773 | 1.156 | 1.062 | 1.449 | .128 | .153 | .198 | 1.280 | 1.130 | .234 | .905 | .908 | .194 |
| 21 | G | 1.3750 | .500 | .545 | .790 | .741 | 1.250 | 1.156 | 1.575 | .128 | .183 | .228 | 1.410 | 1.250 | .204 | .905 | .904 | .194 |
| 23 | H | 1.5000 | .500 | .545 | .790 | .741 | 1.375 | 1.250 | 1.701 | .154 | .183 | .228 | 1.530 | 1.360 | .204 | .905 | .904 | .242 |
| 25 | J | 1.6250 | .500 | .545 | .790 | .741 | 1.500 | 1.375 | 1.823 | .154 | .183 | .228 | 1.660 | 1.470 | .204 | .905 | .904 | .242 |

Millimeters

| Shell Size | MS Shell Size Code | L Max. (TV) | L' Max. (CTV) | M +.00 - .13 (TV) | M' +.00 - .13 (CTV) | R ¹ | R ² | S Max. | T ±.20 | V Thread Metric | Z Max. (TV) | Z' Max. (CTV) | A ¹ Back Panel Mount | A ² Front Panel Mount | AA Max. | LL +.15 - .00 (TV) | LL1 ±.13 (CTV) | TT ±.20 |
|------------|--------------------|-------------|---------------|-------------------|---------------------|----------------|----------------|--------|--------|-----------------|-------------|---------------|---------------------------------|----------------------------------|---------|--------------------|----------------|---------|
| 9 | A | 11.91 | 13.06 | 20.83 | 19.63 | 18.26 | 15.09 | 24.1 | 3.25 | M12X1-6g | 3.89 | 5.03 | 16.66 | 13.11 | 5.94 | 22.99 | 23.06 | 5.49 |
| 11 | B | 11.91 | 13.06 | 20.83 | 19.63 | 20.62 | 18.26 | 26.5 | 3.25 | M15X1-6g | 3.89 | 5.03 | 20.22 | 15.88 | 5.94 | 22.99 | 23.06 | 4.93 |
| 13 | C | 11.91 | 13.06 | 20.83 | 19.63 | 23.01 | 20.62 | 28.9 | 3.25 | M18X1-6g | 3.89 | 5.03 | 23.42 | 19.05 | 5.94 | 22.99 | 23.06 | 4.93 |
| 15 | D | 11.91 | 13.06 | 20.83 | 19.63 | 24.61 | 23.01 | 31.3 | 3.25 | M22X1-6g | 3.89 | 5.03 | 26.59 | 23.01 | 5.94 | 22.99 | 23.06 | 4.39 |
| 17 | E | 11.91 | 13.06 | 20.83 | 19.63 | 26.97 | 24.61 | 33.7 | 3.25 | M25X1-6g | 3.89 | 5.03 | 30.96 | 25.81 | 5.94 | 22.99 | 23.06 | 4.93 |
| 19 | F | 11.91 | 13.06 | 20.83 | 19.63 | 29.36 | 26.97 | 36.9 | 3.25 | M28X1-6g | 3.89 | 5.03 | 32.94 | 28.98 | 5.94 | 22.99 | 23.06 | 4.93 |
| 21 | G | 12.70 | 13.84 | 20.07 | 18.82 | 31.75 | 29.36 | 40.1 | 3.25 | M31X1-6g | 4.65 | 5.79 | 36.12 | 32.16 | 5.18 | 22.99 | 22.96 | 4.93 |
| 23 | H | 12.70 | 13.84 | 20.07 | 18.82 | 34.93 | 31.75 | 43.3 | 3.91 | M34X1-6g | 4.65 | 5.79 | 39.29 | 34.93 | 5.18 | 22.99 | 22.96 | 6.15 |
| 25 | J | 12.70 | 13.84 | 20.07 | 18.82 | 38.10 | 34.93 | 46.4 | 3.91 | M37X1-6g | 4.65 | 5.79 | 42.47 | 37.69 | 5.18 | 22.99 | 22.96 | 6.15 |

All dimensions for reference only

□ Designates true position dimensioning

TVP02R – Crimp, Metal CTVP02R – Crimp, Composite

Box Mounting Receptacle

PART

To complete, see how to order pages 22-24.

| Connector Type | Shell Style | Service Class | Shell Size & Insert Arrg | Contact Type | Alternate Position | Special Variations |
|----------------|-------------|---------------|--------------------------|--------------|--------------------|--------------------|
| TVP | 02 | RW | 9-35 | P | B | (453) |
| TVPS | 02 | RK | X-X | X | X | (XXX) |
| TVPS | 02 | RF | X-X | X | X | (XXX) |
| TVPS | 02 | RS | X-X | X | X | (XXX) |
| CTVP | 02 | RW | X-X | X | X | (XXX) |
| CTVPS | 02 | RF | X-X | X | X | (XXX) |



PANEL HOLE DIMENSIONS



BACK PANEL MOUNTING



FRONT PANEL MOUNTING

† Red band indicates fully mated

†† Blue band indicates rear release contact retention system

Consult Amphenol Aerospace for availability of composite box mount receptacles.

| Shell Size | MS Shell Size Code | B Thread Class 2A 0.1P=0.3L-TS (Plated) | L Max. (TV) | L' Max. (CTV) | M +.000 - .005 (TV) | M' +.000 - .005 (CTV) | R ¹ | R ² | S Max. | T ±.008 | Z Max. (TV) | Z' Max. (CTV) | A ¹ Back Panel Mount | A ² Front Panel Mount | AA Max. Panel Thickness | LL +.006 - .000 (TV) | LL1 ±.005 (CTV) | TT ±.008 |
|------------|--------------------|---|-------------|---------------|---------------------|-----------------------|----------------|----------------|--------|---------|-------------|---------------|---------------------------------|----------------------------------|-------------------------|----------------------|-----------------|----------|
| 9 | A | .6250 | .205 | .250 | .820 | .773 | .719 | .594 | .948 | .128 | .153 | .198 | .650 | .510 | .234 | .905 | .908 | .216 |
| 11 | B | .7500 | .205 | .250 | .820 | .773 | .812 | .719 | 1.043 | .128 | .153 | .198 | .800 | .620 | .234 | .905 | .908 | .194 |
| 13 | C | .8750 | .205 | .250 | .820 | .773 | .906 | .812 | 1.137 | .128 | .153 | .198 | .910 | .740 | .234 | .905 | .908 | .194 |
| 15 | D | 1.0000 | .205 | .250 | .820 | .773 | .969 | .906 | 1.232 | .128 | .153 | .198 | 1.040 | .900 | .234 | .905 | .908 | .173 |
| 17 | E | 1.1875 | .205 | .250 | .820 | .773 | 1.062 | .969 | 1.323 | .128 | .153 | .198 | 1.210 | 1.010 | .234 | .905 | .908 | .194 |
| 19 | F | 1.2500 | .205 | .250 | .820 | .773 | 1.156 | 1.062 | 1.449 | .128 | .153 | .198 | 1.280 | 1.130 | .234 | .905 | .908 | .194 |
| 21 | G | 1.3750 | .235 | .280 | .790 | .741 | 1.250 | 1.156 | 1.575 | .128 | .183 | .228 | 1.410 | 1.250 | .204 | .905 | .904 | .194 |
| 23 | H | 1.5000 | .235 | .280 | .790 | .741 | 1.375 | 1.250 | 1.701 | .154 | .183 | .228 | 1.530 | 1.360 | .204 | .905 | .904 | .242 |
| 25 | J | 1.6250 | .235 | .280 | .790 | .741 | 1.500 | 1.375 | 1.823 | .154 | .183 | .228 | 1.660 | 1.470 | .204 | .905 | .904 | .242 |

Inches

| Shell Size | MS Shell Size Code | L Max. (TV) | L' Max. (CTV) | M +.00 - .13 (TV) | M' +.00 - .13 (CTV) | R ¹ | R ² | S Max. | T ±.20 | Z Max. (TV) | Z' Max. (CTV) | A ¹ Back Panel Mount | A ² Front Panel Mount | AA Max. | LL +.15 - .00 (TV) | LL1 ±.13 (CTV) | TT ±.20 |
|------------|--------------------|-------------|---------------|-------------------|---------------------|----------------|----------------|--------|--------|-------------|---------------|---------------------------------|----------------------------------|---------|--------------------|----------------|---------|
| 9 | A | 5.21 | 6.35 | 20.83 | 19.63 | 18.26 | 15.09 | 24.1 | 3.25 | 3.89 | 5.03 | 16.66 | 13.11 | 5.94 | 22.99 | 23.06 | 5.49 |
| 11 | B | 5.21 | 6.35 | 20.83 | 19.63 | 20.62 | 18.26 | 26.5 | 3.25 | 3.89 | 5.03 | 20.22 | 15.88 | 5.94 | 22.99 | 23.06 | 4.93 |
| 13 | C | 5.21 | 6.35 | 20.83 | 19.63 | 23.01 | 20.62 | 28.9 | 3.25 | 3.89 | 5.03 | 23.42 | 19.05 | 5.94 | 22.99 | 23.06 | 4.93 |
| 15 | D | 5.21 | 6.35 | 20.83 | 19.63 | 24.61 | 23.01 | 31.3 | 3.25 | 3.89 | 5.03 | 26.59 | 23.01 | 5.94 | 22.99 | 23.06 | 4.39 |
| 17 | E | 5.21 | 6.35 | 20.83 | 19.63 | 26.97 | 24.61 | 33.7 | 3.25 | 3.89 | 5.03 | 30.96 | 25.81 | 5.94 | 22.99 | 23.06 | 4.93 |
| 19 | F | 5.21 | 6.35 | 20.83 | 19.63 | 29.36 | 26.97 | 36.9 | 3.25 | 3.89 | 5.03 | 32.94 | 28.98 | 5.94 | 22.99 | 23.06 | 4.93 |
| 21 | G | 5.97 | 7.11 | 20.07 | 18.82 | 31.75 | 29.36 | 40.1 | 3.25 | 4.65 | 5.79 | 36.12 | 32.16 | 5.18 | 22.99 | 22.96 | 4.93 |
| 23 | H | 5.97 | 7.11 | 20.07 | 18.82 | 34.92 | 31.75 | 43.3 | 3.91 | 4.65 | 5.79 | 39.29 | 34.93 | 5.18 | 22.99 | 22.96 | 6.15 |
| 25 | J | 5.97 | 7.11 | 20.07 | 18.82 | 38.10 | 34.92 | 46.4 | 3.91 | 4.65 | 5.79 | 42.47 | 37.69 | 5.18 | 22.99 | 22.96 | 6.15 |

Millimeters

All dimensions for reference only

Designates true position dimensioning

III 38999

II

I

SJT

Matrix 2 26482

Matrix Pyle 83723 III

Release Matrix 5015 Crimp Rear

26500 Pyle

Printed Circuit Board

Transient EMI Filter

Fiber Optics

High Speed Contacts

Options Others

Straight Plug

- 38999 III
- SJT I II
- 26482 Matrix 2
- 83723 III Pyle Matrix
- 5015 Crimp Rear Release Matrix
- 26500 Pyle
- Printed Circuit Board
- EMI Filter Transient
- Fiber Optics
- High Speed Contacts
- Options Others

PART

To complete, see how to order pages 22-24.

| Connector Type | Shell Style | Service Class | Shell Size & Insert Arrg | Contact Type | Alternate Position | Special Variations |
|----------------|-------------|---------------|--------------------------|--------------|--------------------|--------------------|
| TV | 06 | RW | 9-35 | P | B | (453) |
| TVS | 06 | RK | X-X | X | X | (XXX) |
| TVS | 06 | RF | X-X | X | X | (XXX) |
| TVS | 06 | RS | X-X | X | X | (XXX) |
| CTV | 06 | RW | X-X | X | X | (XXX) |
| CTVS | 06 | RF | X-X | X | X | (XXX) |
| D38999/ | 26 | X | X-X | X | X | NA |

METAL



VIEW D FOR SIZE 8 COAXIAL ONLY, RELATIVE TO -A-



COMPOSITE

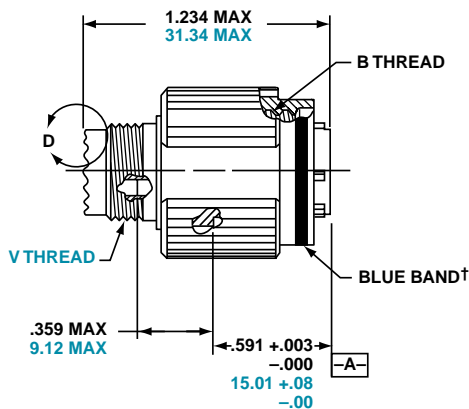

VIEW D FOR SIZE 8 TWINAX ONLY, RELATIVE TO -A-



† Blue band indicates rear release contact retention system

Inches

| Shell Size | MS Shell Size Code | B Thread 0.1P-0.3L-TS-2B (Plated) | Q Dia. Max. |
|------------|--------------------|-----------------------------------|-------------|
| 9 | A | .6250 | .858 |
| 11 | B | .7500 | .984 |
| 13 | C | .8750 | 1.157 |
| 15 | D | 1.0000 | 1.280 |
| 17 | E | 1.1875 | 1.406 |
| 19 | F | 1.2500 | 1.516 |
| 21 | G | 1.3750 | 1.642 |
| 23 | H | 1.5000 | 1.768 |
| 25 | J | 1.6250 | 1.890 |

Millimeters

| Shell Size | MS Shell Size Code | Q Max. | V Thread Metric |
|------------|--------------------|--------|-----------------|
| 9 | A | 21.8 | M12X1-6g |
| 11 | B | 25.0 | M15X1-6g |
| 13 | C | 29.4 | M18X1-6g |
| 15 | D | 32.5 | M22X1-6g |
| 17 | E | 35.7 | M25X1-6g |
| 19 | F | 38.5 | M28X1-6g |
| 21 | G | 41.7 | M31X1-6g |
| 23 | H | 44.9 | M34X1-6g |
| 25 | J | 48.0 | M37X1-6g |

All dimensions for reference only.

TV26/MTV26 – Crimp, Metal CLUTCH-LOK™ Plug



For High Vibration Applications

PART

To complete, see how to order pages 22-24.

| Connector Type | Shell Style | Service Class | Shell Size & Insert Arrg | Contact Type | Alternate Position | Special Variations |
|----------------|-------------|---------------|--------------------------|--------------|--------------------|--------------------|
| TV | 26 | RK | 9-35 | P | N | (453) |
| TV | 26 | RS | X-X | X | N | (XXX) |
| MTV | 26 | RK | X-X | X | N | (XXX) |
| MTV | 26 | RS | X-X | X | N | (XXX) |

For parts with MS Stamping use MTV26() part number as shown above.

Designed for high vibration and harsh environments such as aircraft gas turbine engines, the CLUTCH-LOK is also an ideal choice for demanding applications such as aircraft, space and military ground vehicles. The unique clutch design of the Amphenol CLUTCH-LOK means that you don't have to compromise the need for quick, smooth mating of plugs and receptacles in order to get increased uncoupling torque.

The CLUTCH-LOK has proven to not only remain mated and pass all the Series III specification requirements, it also has proven to actually tighten itself under vibration. This is a powerful advantage over the traditionally high vibration application connectors. The CLUTCH-LOK is also a tremendous advantage in inaccessible, hard to reach areas where mating torque is difficult to apply and complete coupling is not verifiable by inspection.

CLUTCH-LOK features and benefits:

- High degree of differential torque
- Infinite free coupling and positive metal-to-metal bottoming with each mating
- No settling back to the next ratchet tooth
- Available with stainless steel shells and Class K firewall inserts
- All the advantages of MIL-DTL-38999 Series III including EMI/RFI shielding, electrolytic erosion resistance and contact protection with recessed pins
- Enhanced connector performance at affordable prices
- Completely intermateable with all existing MIL-DTL-38999 Series III connectors
- Fully QPL'd

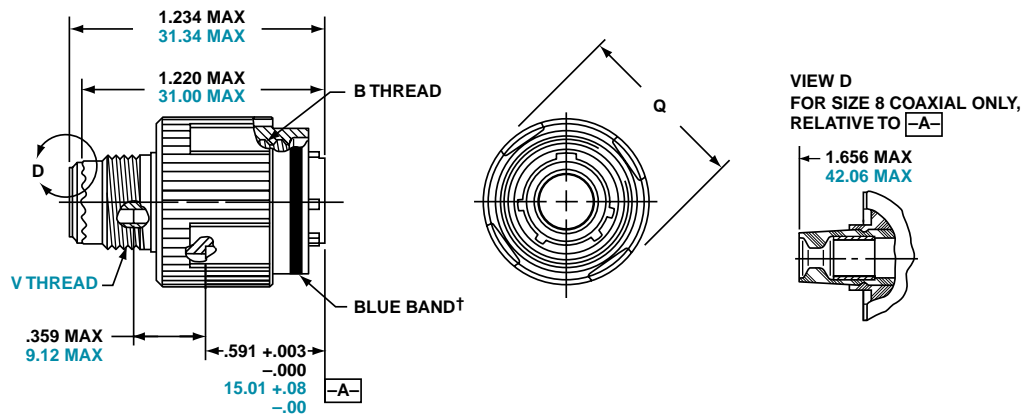

† Blue band indicates rear release contact retention system

| Shell Size | MS Shell Size Code | B Thread 0.1P-0.3L-TS-2B (Plated) | Q Dia. Max. |
|------------|--------------------|-----------------------------------|-------------|
| 9 | A | .6250 | .858 |
| 11 | B | .7500 | .984 |
| 13 | C | .8750 | 1.157 |
| 15 | D | 1.0000 | 1.280 |
| 17 | E | 1.1875 | 1.406 |
| 19 | F | 1.2500 | 1.516 |
| 21 | G | 1.3750 | 1.642 |
| 23 | H | 1.5000 | 1.768 |
| 25 | J | 1.6250 | 1.890 |

| Shell Size | MS Shell Size Code | Q Max. | V Thread Metric |
|------------|--------------------|--------|-----------------|
| 9 | A | 21.8 | M12X1-6g |
| 11 | B | 25.0 | M15X1-6g |
| 13 | C | 29.4 | M18X1-6g |
| 15 | D | 32.5 | M22X1-6g |
| 17 | E | 35.7 | M25X1-6g |
| 19 | F | 38.5 | M28X1-6g |
| 21 | G | 41.7 | M31X1-6g |
| 23 | H | 44.9 | M34X1-6g |
| 25 | J | 48.0 | M37X1-6g |

All dimensions for reference only.

- III 38999 SJT
- Matrix 2 26482
- Matrix Pyle 83723 III
- Release Matrix 5015 Crimp Rear
- 26500 Pyle
- Printed Circuit Board
- EMI Filter Transient
- Fiber Optics
- High Speed Contacts
- Options Others

Jam Nut Receptacle

38999
SJT I II III

26482
Matrix 2

83723 III
Matrix Pyle

5015
Crimp Rear Release Matrix

26500 Pyle

Printed
Circuit Board

EMI Filter
Transient

Fiber Optics

High Speed
Contacts

Options
Others

PART

To complete, see how to order pages 22-24.

| Connector Type | Shell Style | Service Class | Shell Size & Insert Arrg | Contact Type | Alternate Position | Special Variations |
|----------------|-------------|---------------|--------------------------|--------------|--------------------|--------------------|
| TV | 07 | RW | 9-35 | P | B | (453) |
| TVS | 07 | RK | X-X | X | X | (XXX) |
| TVS | 07 | RF | X-X | X | X | (XXX) |
| TVS | 07 | RS | X-X | X | X | (XXX) |
| CTV | 07 | RW | X-X | X | X | (XXX) |
| CTVS | 07 | RF | X-X | X | X | (XXX) |
| D38999/ | 24 | X | X-X | X | X | NA |



† Red band indicates fully mated

†† Blue band indicates rear release contact retention system

★ .059 dia min.

1.5 dia min., 3 lockwire holes Formed lockwire hole design (6 holes) is optional Inches

| Shell Size | MS Shell Size Code | B Thread Class 2A 0.1P-0.3L-TS (Plated) | C Max. | D ¹ +.010 - .000 | D ² +.000 - .010 | H Hex +.017 - .016 | S ±.010 |
|------------|--------------------|---|--------|-----------------------------|-----------------------------|--------------------|---------|
| 9 | A | .6250 | 1.199 | .700 | .670 | .875 | 1.062 |
| 11 | B | .7500 | 1.386 | .825 | .770 | 1.000 | 1.250 |
| 13 | C | .8750 | 1.511 | 1.010 | .955 | 1.188 | 1.375 |
| 15 | D | 1.0000 | 1.636 | 1.135 | 1.085 | 1.312 | 1.500 |
| 17 | E | 1.1875 | 1.761 | 1.260 | 1.210 | 1.438 | 1.625 |
| 19 | F | 1.2500 | 1.949 | 1.385 | 1.335 | 1.562 | 1.812 |
| 21 | G | 1.3750 | 2.073 | 1.510 | 1.460 | 1.688 | 1.938 |
| 23 | H | 1.5000 | 2.199 | 1.635 | 1.585 | 1.812 | 2.062 |
| 25 | J | 1.6250 | 2.323 | 1.760 | 1.710 | 2.000 | 2.188 |

Millimeters

| Shell Size | MS Shell Size Code | C Max. | D ¹ +.25 - .00 | D ² +.00 - .25 | H Hex +.43 - .41 | S ±.25 | V Thread Metric |
|------------|--------------------|--------|---------------------------|---------------------------|------------------|--------|-----------------|
| 9 | A | 30.45 | 17.78 | 17.02 | 22.23 | 26.97 | M12X1-6g |
| 11 | B | 35.20 | 20.96 | 19.59 | 25.40 | 31.75 | M15X1-6g |
| 13 | C | 38.38 | 25.65 | 24.26 | 30.18 | 34.93 | M18X1-6g |
| 15 | D | 41.55 | 28.83 | 27.56 | 33.32 | 38.10 | M22X1-6g |
| 17 | E | 44.73 | 32.01 | 30.73 | 36.53 | 41.28 | M25X1-6g |
| 19 | F | 49.50 | 35.18 | 33.91 | 39.67 | 46.02 | M28X1-6g |
| 21 | G | 52.65 | 38.35 | 37.08 | 42.80 | 49.23 | M31X1-6g |
| 23 | H | 55.85 | 41.53 | 40.26 | 46.02 | 52.37 | M34X1-6g |
| 25 | J | 59.00 | 44.70 | 43.43 | 50.80 | 55.58 | M37X1-6g |

All dimensions for reference only NOTE: Deep reach receptacles are available for panel thicknesses up to .750 max.

TV01R – Crimp, Metal CTV01R – Crimp, Composite

Line Receptacle

PART

To complete, see how to order pages 22-24.

| Connector Type | Shell Style | Service Class | Shell Size & Insert Arrg | Contact Type | Alternate Position | Special Variations |
|----------------|-------------|---------------|--------------------------|--------------|--------------------|--------------------|
| TV | 01 | RW | 9-35 | P | B | (453) |
| TVS | 01 | RF | X-X | X | X | (XXX) |
| CTV | 01 | RW | X-X | X | X | (XXX) |
| CTVS | 01 | RF | X-X | X | X | (XXX) |

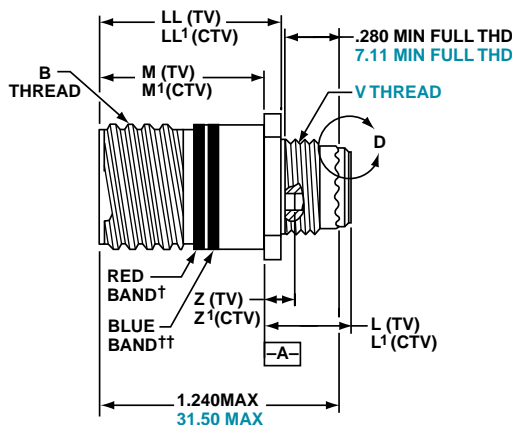

VIEW D
FOR SIZE 8 COAXIAL ONLY,
RELATIVE TO -A-

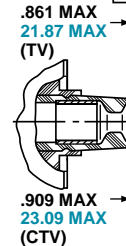

VIEW D
FOR SIZE 8 TWINAX ONLY,
RELATIVE TO -A-

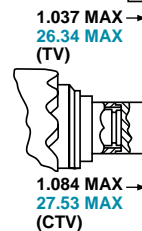

† Red band indicates fully mated

†† Blue band indicates rear release contact retention system

| Shell Size | MS Shell Size Code | B Thread 0.1P-0.3L-TS-2A (Plated) | M +.000 - .005 (TV) | M' +.000 - .005 (CTV) | L Max. (TV) | L' Max. (CTV) | S ±.010 (TV) | S' ±.010 (CTV) | Z Max (TV) | Z' Max (CTV) | GG ±.010 (TV) | GG' ±.010 (CTV) | LL +.006 - .000 (TV) | LL' ±.005 (CTV) |
|------------|--------------------|-----------------------------------|---------------------|-----------------------|-------------|---------------|--------------|----------------|------------|--------------|---------------|-----------------|----------------------|-----------------|
| 9 | A | .6250 | .820 | .773 | .469 | .514 | .675 | .635 | .153 | .198 | .812 | .699 | .905 | .908 |
| 11 | B | .7500 | .820 | .773 | .469 | .514 | .800 | .765 | .153 | .198 | .905 | .875 | .905 | .908 |
| 13 | C | .8750 | .820 | .773 | .469 | .514 | .925 | .885 | .153 | .198 | 1.093 | 1.007 | .905 | .908 |
| 15 | D | 1.0000 | .820 | .773 | .469 | .514 | 1.050 | 1.100 | .153 | .198 | 1.219 | 1.140 | .905 | .908 |
| 17 | E | 1.1875 | .820 | .773 | .469 | .514 | 1.238 | 1.197 | .153 | .198 | 1.375 | 1.229 | .905 | .908 |
| 19 | F | 1.2500 | .820 | .773 | .469 | .514 | 1.300 | 1.260 | .153 | .198 | 1.469 | 1.380 | .905 | .908 |
| 21 | G | 1.3750 | .790 | .741 | .500 | .545 | 1.425 | 1.385 | .183 | .228 | 1.625 | 1.493 | .905 | .904 |
| 23 | H | 1.5000 | .790 | .741 | .500 | .545 | 1.550 | 1.510 | .183 | .228 | 1.750 | 1.626 | .905 | .904 |
| 25 | J | 1.6250 | .790 | .741 | .500 | .545 | 1.675 | 1.635 | .183 | .228 | 1.875 | 1.777 | .905 | .904 |

| Shell Size | MS Shell Size Code | M +.00 - .013 (TV) | M' +.00 - .13 (CTV) | L Max. (TV) | L' Max. (CTV) | S ±.25 (TV) | S' ±.010 (CTV) | V Thread Metric | Z Max (TV) | Z' Max (CTV) | GG ±.25 (TV) | GG' ±.25 (CTV) | LL +.15 - .00 (TV) | LL' ±.13 (CTV) |
|------------|--------------------|--------------------|---------------------|-------------|---------------|-------------|----------------|-----------------|------------|--------------|--------------|----------------|--------------------|----------------|
| 9 | A | 20.83 | 19.63 | 11.91 | 13.06 | 17.15 | 16.13 | M12X1-6g | 3.89 | 5.03 | 20.62 | 17.75 | 22.99 | 23.06 |
| 11 | B | 20.83 | 19.63 | 11.91 | 13.06 | 20.32 | 19.43 | M15X1-6g | 3.89 | 5.03 | 22.99 | 22.22 | 22.99 | 23.06 |
| 13 | C | 20.83 | 19.63 | 11.91 | 13.06 | 23.50 | 22.47 | M18X1-6g | 3.89 | 5.03 | 27.76 | 25.57 | 22.99 | 23.06 |
| 15 | D | 20.83 | 19.63 | 11.91 | 13.06 | 26.67 | 27.94 | M22X1-6g | 3.89 | 5.03 | 30.96 | 28.95 | 22.99 | 23.06 |
| 17 | E | 20.83 | 19.63 | 11.91 | 13.06 | 31.45 | 30.40 | M25X1-6g | 3.89 | 5.03 | 34.93 | 31.21 | 22.99 | 23.06 |
| 19 | F | 20.83 | 19.63 | 11.91 | 13.06 | 33.02 | 32.00 | M28X1-6g | 3.89 | 5.03 | 37.31 | 35.05 | 22.99 | 23.06 |
| 21 | G | 20.07 | 18.82 | 12.70 | 13.84 | 36.20 | 35.18 | M31X1-6g | 4.65 | 5.79 | 41.28 | 37.92 | 22.99 | 22.96 |
| 23 | H | 20.07 | 18.82 | 12.70 | 13.84 | 39.37 | 38.35 | M34X1-6g | 4.65 | 5.79 | 44.45 | 41.30 | 22.99 | 22.96 |
| 25 | J | 20.07 | 18.82 | 12.70 | 13.84 | 42.55 | 41.53 | M37X1-6g | 4.65 | 5.79 | 47.63 | 45.13 | 22.99 | 22.96 |

All dimensions for reference only

38999
SJT

26482
Matrix 2

83723 III
Matrix Pyle

5015
Crimp Rear Release Matrix

26500 Pyle

Printed
Circuit Board

EM I Filter
Transient

Fiber Optics

High Speed
Contacts

Options
Others

38999

26482 Matrix 2

83723 III Matrix Pyle

5015 Crimp Rear Release Matrix

26500 Pyle

Printed Circuit Board

EMI Filter Transient

Fiber Optics

High Speed Contacts

Options Others

PART

To complete, see how to order pages 22-24.

| Connector Type | Shell Style | Service Class | Shell Size & Insert Arrg | Contact Type | Alternate Position | Special Variations |
|----------------|-------------|---------------|--------------------------|--------------|--------------------|--------------------|
| TV | 09 | RW | 9-35 | P | B | (453) |
| TVS | 09 | RF | X-X | X | X | (000X) |

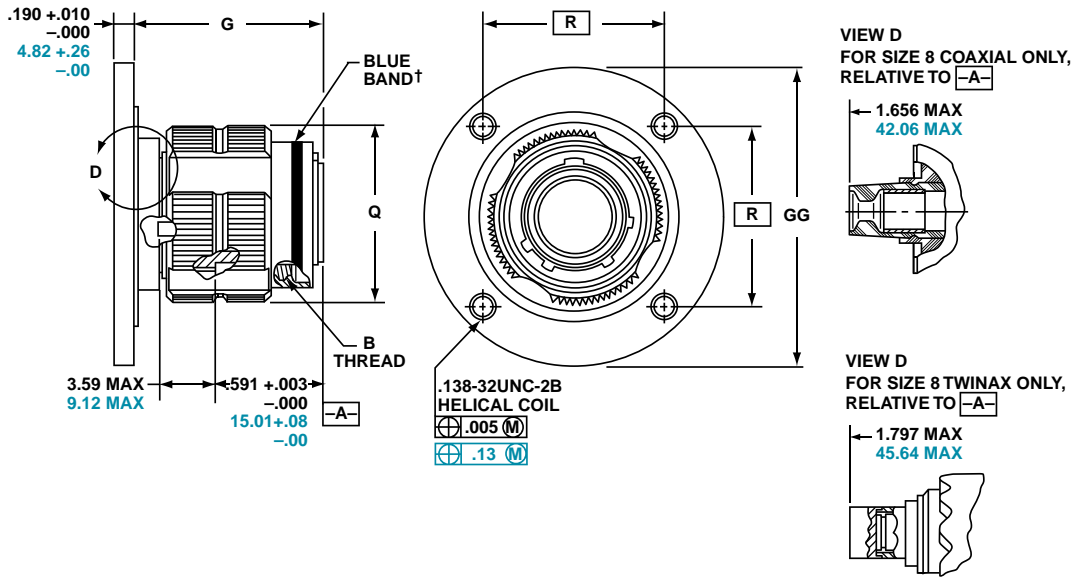

† Blue band indicates rear release contact retention system

Inches

| Shell Size | MS Shell Size Coded | B Thread 0.1P-0.3L-TS-2A (Plated) | G $\pm .060$ | Q Dia. Max | R | GG Dia $\pm .005$ |
|------------|---------------------|-----------------------------------|--------------|------------|-------|-------------------|
| 9** | A | .6250 | 1.106 | .859 | 1.038 | 1.838 |
| 11 | B | .7500 | 1.106 | .969 | 1.115 | 1.948 |
| 13** | C | .8750 | 1.106 | 1.141 | 1.240 | 2.124 |
| 15 | D | 1.0000 | 1.106 | 1.266 | 1.327 | 2.248 |
| 17 | E | 1.1875 | 1.106 | 1.391 | 1.417 | 2.375 |
| 19 | F | 1.2500 | 1.356 | 1.500 | 1.557 | 2.495 |
| 21 | G | 1.3750 | 1.356 | 1.625 | 1.624 | 2.568 |
| 23 | H | 1.5000 | 1.356 | 1.750 | 1.713 | 2.723 |
| 25 | J | 1.6250 | 1.356 | 1.875 | 1.801 | 2.848 |

Millimeters

| Shell Size | MS Shell Size Coded | G ± 1.52 | Q Dia. Max | R | GG Dia ± 13 |
|------------|---------------------|--------------|------------|-------|-----------------|
| 9** | A | 28.09 | 21.82 | 26.37 | 46.69 |
| 11 | B | 28.09 | 24.62 | 28.32 | 49.48 |
| 13** | C | 28.09 | 28.98 | 31.50 | 53.95 |
| 15 | D | 28.09 | 32.16 | 33.71 | 57.10 |
| 17 | E | 28.09 | 35.33 | 35.99 | 60.33 |
| 19 | F | 34.44 | 38.10 | 39.55 | 63.37 |
| 21 | G | 34.44 | 41.28 | 41.25 | 65.23 |
| 23 | H | 34.44 | 44.45 | 43.51 | 69.16 |
| 25 | J | 34.44 | 47.63 | 45.75 | 72.34 |

All dimensions for reference only

** Partially tooled. Consult Amphenol Aerospace for availability

 Designates true position dimensioning

TVPS02Y (D38999/21) – Hermetic

Stainless Steel

Box Mounting Receptacle

PART

To complete, see how to order pages 22-24.

| Connector Type | Shell Style | Service Class | Shell Size & Insert Arrg | Contact Type | Alternate Position | Special Variations |
|----------------|-------------|---------------|--------------------------|--------------|--------------------|--------------------|
| TVPS | 02 | Y | 9-35 | P | B | (453) |
| TVPS | 02 | YN | X-X | X | X | (XXX) |
| D38999/ | 21 | X | X-X | X | X | NA |

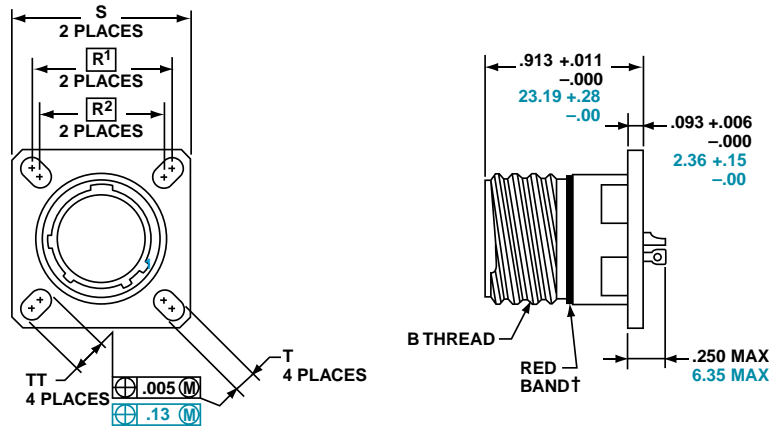

† Red band indicates fully mated

NOTE: Consult Amphenol Aerospace for availability of non-glass-sealed versions with printed circuit tail contacts.

Inches

| Shell Size | MS Shell Size Coded | B Thread 0.1P-0.3L-TS (Plated) | R1 | R2 | S ±.010 | T ±.008 | TT ±.008 |
|------------|---------------------|--------------------------------|-------|-------|---------|---------|----------|
| 9 | A | .6250 | .719 | .594 | .938 | .128 | .216 |
| 11 | B | .7500 | .812 | .719 | 1.031 | .128 | .194 |
| 13 | C | .8750 | .906 | .812 | 1.125 | .128 | .194 |
| 15 | D | 1.0000 | .969 | .906 | 1.219 | .128 | .173 |
| 17 | E | 1.1875 | 1.062 | .969 | 1.312 | .128 | .194 |
| 19 | F | 1.2500 | 1.156 | 1.062 | 1.438 | .128 | .194 |
| 21 | G | 1.3750 | 1.250 | 1.156 | 1.562 | .128 | .194 |
| 23 | H | 1.5000 | 1.375 | 1.250 | 1.688 | .154 | .242 |
| 25 | J | 1.6250 | 1.500 | 1.375 | 1.812 | .154 | .242 |

Millimeters

| Shell Size | MS Shell Size Coded | R1 | R2 | S ±.25 | T ±.20 | TT ±.20 |
|------------|---------------------|-------|-------|--------|--------|---------|
| 9 | A | 18.26 | 15.09 | 23.83 | 3.25 | 5.49 |
| 11 | B | 20.62 | 18.26 | 26.19 | 3.25 | 4.93 |
| 13 | C | 23.01 | 20.62 | 28.58 | 3.25 | 4.93 |
| 15 | D | 24.61 | 23.01 | 30.96 | 3.25 | 4.39 |
| 17 | E | 26.97 | 24.61 | 33.32 | 3.25 | 4.93 |
| 19 | F | 29.36 | 26.97 | 36.53 | 3.25 | 4.93 |
| 21 | G | 31.75 | 29.36 | 39.67 | 3.25 | 4.93 |
| 23 | H | 34.93 | 31.75 | 42.88 | 3.91 | 6.15 |
| 25 | J | 38.10 | 34.93 | 46.02 | 3.91 | 6.15 |

All dimensions for reference only

Designates true position dimensioning

- III 38999
- II
- I
- SJT
- 26482 Matrix 2
- 83723 III Matrix Pyle
- 5015 Crimp Rear Release Matrix
- 26500 Pyle
- Printed Circuit Board
- EMI Filter Transient
- Fiber Optics
- High Speed Contacts
- Options Others

Jam Nut Receptacle

38999
SJT I II III

PART

To complete, see how to order pages 22-24.

| Connector Type | Shell Style | Service Class | Shell Size & Insert Arrg | Contact Type | Alternate Position | Special Variations |
|----------------|-------------|---------------|--------------------------|--------------|--------------------|--------------------|
| TVS | 07 | Y | 9-35 | P | B | (453) |
| TVS | 07 | YN | X-X | X | X | (XXX) |
| D38999/ | 23 | X | X-X | X | X | NA |

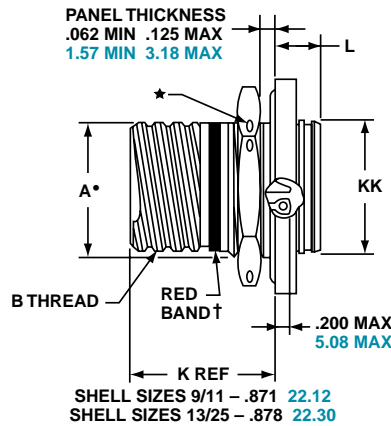
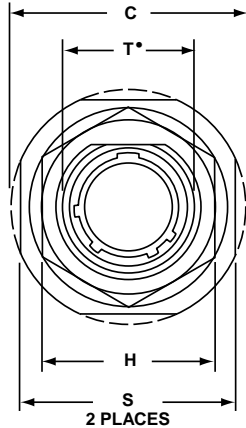

PANEL HOLE DIMENSIONS

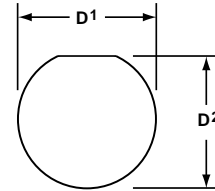

JAM NUT D-HOLE MOUNTING

† Red band indicates fully mated

★ .059 dia min.

1.5 dia min. 3 lockwire holes

Formed lockwire hole design (6 holes) is optional.

Inches

| Shell Size | MS Shell Size code | A* +.000 -.010 | B Thread Class 2A 0.1P- 0.3L-TS (Plated) | C Max | D' +.010 -.000 | D' +.000 -.010 | H Hex +.017 -.016 | L Max | S ±.010 | T* +.010 -.000 | KK +.011 -.000 |
|------------|--------------------|-------------------|---|-------|-------------------|-------------------|-------------------------|-------|---------|-------------------|-------------------|
| 9 | A | .669 | .6250 | 1.199 | .700 | .670 | .875 | .357 | 1.062 | .697 | .642 |
| 11 | B | .769 | .7500 | 1.386 | .825 | .770 | 1.000 | .357 | 1.250 | .822 | .766 |
| 13 | C | .955 | .8750 | 1.511 | 1.010 | .955 | 1.188 | .357 | 1.375 | 1.007 | .892 |
| 15 | D | 1.084 | 1.0000 | 1.636 | 1.135 | 1.085 | 1.312 | .357 | 1.500 | 1.134 | 1.018 |
| 17 | E | 1.208 | 1.1875 | 1.761 | 1.260 | 1.210 | 1.438 | .357 | 1.625 | 1.259 | 1.142 |
| 19 | F | 1.333 | 1.2500 | 1.949 | 1.385 | 1.335 | 1.562 | .381 | 1.812 | 1.384 | 1.268 |
| 21 | G | 1.459 | 1.3750 | 2.073 | 1.510 | 1.460 | 1.688 | .381 | 1.938 | 1.507 | 1.392 |
| 23 | H | 1.575 | 1.5000 | 2.199 | 1.635 | 1.585 | 1.812 | .381 | 2.062 | 1.634 | 1.518 |
| 25 | J | 1.709 | 1.6250 | 2.323 | 1.760 | 1.710 | 2.000 | .381 | 2.188 | 1.759 | 1.642 |

Millimeters

| Shell Size | MS Shell Size code | A* +.00 --.25 | C Max | D' +.25 --.00 | D' +.00 --.25 | H Hex +.43 -.41 | L Max | S ±.25 | T* +.25 -.00 | KK +.28 -.00 |
|------------|--------------------|---------------|-------|---------------|---------------|-----------------------|-------|--------|-----------------|-----------------|
| 9 | A | 16.99 | 30.45 | 17.78 | 17.02 | 22.23 | 9.07 | 26.97 | 17.70 | 16.31 |
| 11 | B | 19.53 | 35.20 | 20.96 | 19.59 | 25.40 | 9.07 | 31.75 | 20.88 | 19.46 |
| 13 | C | 24.26 | 38.38 | 25.65 | 24.26 | 30.18 | 9.07 | 34.93 | 25.58 | 22.66 |
| 15 | D | 27.53 | 41.55 | 28.83 | 27.56 | 33.32 | 9.07 | 38.10 | 28.80 | 25.86 |
| 17 | E | 30.68 | 44.73 | 32.01 | 30.73 | 36.53 | 9.07 | 41.28 | 31.98 | 29.01 |
| 19 | F | 33.86 | 49.50 | 35.18 | 33.91 | 39.67 | 9.68 | 46.02 | 35.15 | 32.21 |
| 21 | G | 37.06 | 52.65 | 38.35 | 37.08 | 42.80 | 9.68 | 49.23 | 38.28 | 35.36 |
| 23 | H | 40.01 | 55.85 | 41.53 | 40.26 | 46.02 | 9.68 | 52.37 | 41.50 | 38.56 |
| 25 | J | 43.41 | 59.00 | 44.70 | 43.43 | 50.80 | 9.68 | 55.58 | 44.68 | 41.71 |

All dimensions for reference only

• D shaped panel cut-out dimensions

26482
Matrix 2

83723 III
Matrix Pyle

5015
Crimp Rear
Release Matrix

26500 Pyle

Printed
Circuit Board

EMI Filter
Transient

Fiber Optics

High Speed
Contacts

Options
Others

TVSIY (D38999/25) – Hermetic Stainless Steel

Solder Mounting Receptacle

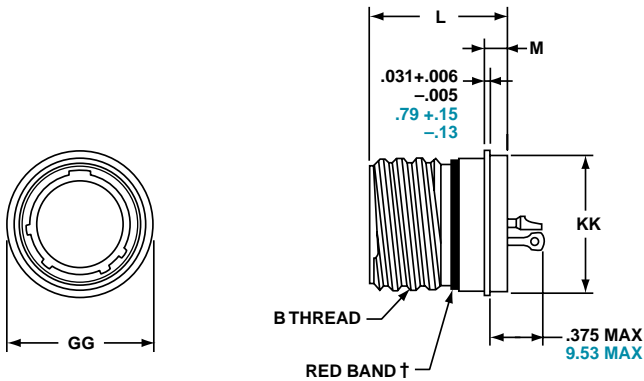

† Red band indicates fully mated

Inches

| Shell Size | MS Shell Size Code | B Thread Class 2A 0.1P-0.3L-TS (Plated) | L +.011 - .005 | M +.006 - .005 | GG Dia. +.011 - .010 | KK Dia +.011 - .005 |
|------------|--------------------|---|----------------|----------------|----------------------|---------------------|
| 9 | A | .6250 | .806 | .125 | .750 | .672 |
| 11 | B | .7500 | .806 | .125 | .844 | .781 |
| 13 | C | .8750 | .806 | .125 | .969 | .906 |
| 15 | D | 1.0000 | .806 | .125 | 1.094 | 1.031 |
| 17 | E | 1.1875 | .806 | .125 | 1.218 | 1.156 |
| 19 | F | 1.2500 | .806 | .125 | 1.312 | 1.250 |
| 21 | G | 1.3750 | .806 | .125 | 1.438 | 1.375 |
| 23 | H | 1.5000 | .838 | .156 | 1.563 | 1.500 |
| 25 | J | 1.6250 | .838 | .156 | 1.688 | 1.625 |

Millimeters

| Shell Size | MS Shell Size Code | L +.28 - .00 | M +.15 - .13 | GG Dia. +.28 - .25 | KK Dia +.03 - .13 |
|------------|--------------------|--------------|--------------|--------------------|-------------------|
| 9 | A | 20.47 | 3.18 | 19.05 | 17.07 |
| 11 | B | 20.47 | 3.18 | 21.44 | 19.84 |
| 13 | C | 20.47 | 3.18 | 24.61 | 23.01 |
| 15 | D | 20.47 | 3.18 | 27.79 | 26.19 |
| 17 | E | 20.47 | 3.18 | 30.94 | 29.36 |
| 19 | F | 20.47 | 3.18 | 33.32 | 31.75 |
| 21 | G | 20.47 | 3.18 | 36.53 | 34.93 |
| 23 | H | 21.29 | 3.96 | 39.70 | 38.10 |
| 25 | J | 21.29 | 3.96 | 42.88 | 41.28 |

PART

To complete, see how to order pages 22-24.

| Connector Type | Shell Style | Service Class | Shell Size & Insert Arrg | Contact Type | Alternate Position | Special Variations |
|----------------|-------------|---------------|--------------------------|--------------|--------------------|--------------------|
| TVS | I | Y | 9-35 | P | B | (453) |
| TVS | I | YN | X-X | X | X | (XXX) |
| D38999/ | 25 | X | X-X | X | X | NA |

TVSHIY (D38999/27) – Hermetic, Stainless Steel

Weld Mounting Receptacle

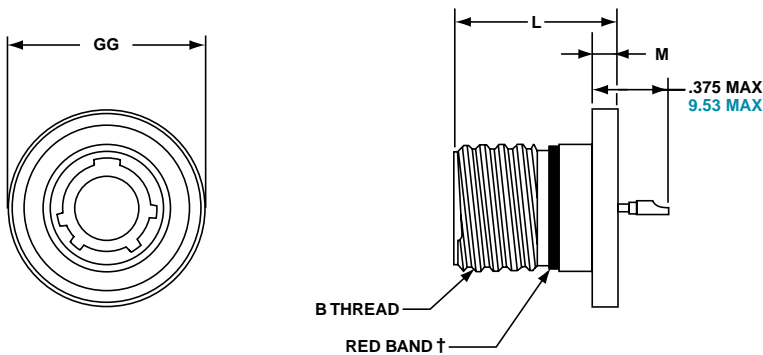

† Red band indicates fully mated

Inches

| Shell Size | MS Shell Size Code | B Thread Class 2A 0.1P-0.3L-TS (Plated) | L +.011 - .000 | M +.006 - .005 | GG Dia. +.011 - .010 |
|------------|--------------------|---|----------------|----------------|----------------------|
| 9 | A | .6250 | .806 | .125 | .973 |
| 11 | B | .7500 | .806 | .125 | 1.095 |
| 13 | C | .8750 | .806 | .125 | 1.221 |
| 15 | D | 1.0000 | .806 | .125 | 1.347 |
| 17 | E | 1.1875 | .806 | .125 | 1.434 |
| 19 | F | 1.2500 | .806 | .125 | 1.579 |
| 21 | G | 1.3750 | .806 | .125 | 1.721 |
| 23 | H | 1.5000 | .838 | .156 | 1.886 |
| 25 | J | 1.6250 | .838 | .156 | 1.973 |

Millimeters

| Shell Size | MS Shell Size Code | L +.28 - .00 | M +.15 - .13 | GG Dia. +.25 - .00 |
|------------|--------------------|--------------|--------------|--------------------|
| 9 | A | 20.47 | 3.18 | 24.71 |
| 11 | B | 20.47 | 3.18 | 27.81 |
| 13 | C | 20.47 | 3.18 | 31.01 |
| 15 | D | 20.47 | 3.18 | 34.21 |
| 17 | E | 20.47 | 3.18 | 36.42 |
| 19 | F | 20.47 | 3.18 | 40.11 |
| 21 | G | 20.47 | 3.18 | 43.71 |
| 23 | H | 21.29 | 3.96 | 47.90 |
| 25 | J | 21.29 | 3.96 | 50.11 |

PART

To complete, see how to order pages 22-24.

| Connector Type | Shell Style | Service Class | Shell Size & Insert Arrg | Contact Type | Alternate Position | Special Variations |
|----------------|-------------|---------------|--------------------------|--------------|--------------------|--------------------|
| TVS | HI | Y | 9-35 | P | B | (453) |
| TVS | HI | YN | X-X | X | X | (XXX) |
| D38999/ | 27 | X | X-X | X | X | NA |

All dimensions for reference only

- III 38999
- II
- I
- SJT
- 26482 Matrix 2
- 83723 III Matrix Pyle
- 5015 Crimp Rear Release Matrix
- 26500 Pyle
- Printed Circuit Board
- EMI Filter Transient
- Fiber Optics
- High Speed Contacts
- Options Others

38999
SJT I II III

26482
Matrix 2

83723 III
Matrix Pyle

5015
Crimp Rear Release Matrix

26500 Pyle

Printed
Circuit Board

EMI Filter
Transient

Fiber Optics

High Speed
Contacts

Options
Others

Amphenol® Tri-Start Breakaway Fail Safe Connectors provide unequalled performance in environments requiring instant disengagement.

Designed to provide quick disconnect of a connector plug and receptacle with an axial pull on the lanyard, the "Breakaway" Fail Safe connector family offers a wide range of electrical and mechanical features:

- Instant decoupling and damage free separation
- Completely intermateable with standard receptacles (D38999/20 and /24)
- Inventory support commonality through the use of standard insert arrangements and contacts

Breakaway un-mating is initiated by applying a pull force to the lanyard which causes the operating sleeve on the plug to move away from the receptacle. Coupling segments on the plug then move away from the mating receptacle while expanding, thus releasing the receptacle. After completion of the un-mating sequence, spring compression returns the sleeve and segments to their original positions. Un-mating of the plug may also be accomplished by normal rotation of the coupling ring without affecting the breakaway capability.



Amphenol offers a variety of lanyard plug styles including MIL-STD-1760 types 1, 2 and 6 for Stores Management applications.

The Tri-Start Breakaway Fail Safe connector exceeds the MIL-Spec Series III requirements for EMI/EMP shielding and features include:

- Solid metal-to-metal coupling
- EMI grounding fingers
- Conductive finishes

Amphenol Breakaway Fail Safe connectors are qualified to MIL-DTL-38999/29, /30 and /31 (for MIL-STD-1760 Stores Management applications). In fact, Amphenol offers more qualified Breakaway shell size and insert combinations than any other QPL supplier.

In addition to standard Breakaway connectors, Amphenol also manufactures custom breakaway connectors including those with:

- Highly durable non-metallic operating sleeves in a variety of lengths and diameters
- Increased pull-force capability
- Low-profile designs
- Custom lanyard lengths and backshells
- Low force separation capabilities
- Low insertion/separation force contacts
- Non-cadmium finishes

Whether you need a standard Breakaway, one of our custom Breakaways or, a unique Breakaway design, please contact your local Amphenol representative.

Contact Amphenol Aerospace for more information on breakaway, quick-disconnect connectors. Other Amphenol circular families (MIL-DTL-26482, MIL-DTL-83723) also offer breakaway quick-disconnect connectors.

See accessories for breakaway connectors on page 90.



Breakaway with Coax Contacts



Special configuration Fail Safe used on space telescope application. Lanyard is replaced by a swivel ring for remote disconnect and "wing arms" have been added for manual actuation accessibility by gloved astronauts.

PART

To complete, see how to order pages 38-39.

| Connector Type | Shell Style | Shell Size & Insert Arrg | Lanyard Length Code | Contact Type/Alternate Insert Rotation | |
|----------------|-------------|--------------------------|---------------------|--|----------------|
| D38999 | 29 | 29 | E | P | (Pins Only) |
| D38999 | 30 | X-X | X | X | (Sockets Only) |
| 88 | 5565 | X-X | X | X | |
| 91 | 5565 | X-X | X | X | |

METAL

.374 MAX
9.50 MAX
OUTER SLEEVE MOVEMENT
DURING UNMATING THREAD RELEASE

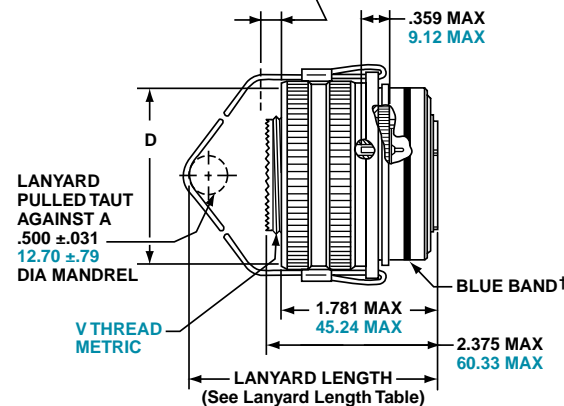

† Blue band indicates rear release contact retention system

Inches

| Shell Size | MS Shell Size Code | B Max | D Max Accessory Dia. |
|------------|--------------------|-------|----------------------|
| 11 | B | 1.846 | 1.109 |
| 13 | C | 1.972 | 1.250 |
| 15 | D | 2.079 | 1.375 |
| 17 | E | 2.205 | 1.500 |
| 19 | F | 2.301 | 1.625 |
| 21 | G | 2.472 | 1.750 |
| 23 | H | 2.594 | 1.875 |
| 25 | J | 2.705 | 2.000 |

Millimeters

| Shell Size | MS Shell Size Code | B Max | D Max Accessory Dia. | V Thread Metric |
|------------|--------------------|-------|----------------------|-----------------|
| 11 | B | 46.89 | 28.17 | M15X1.0-6g |
| 13 | C | 50.09 | 31.75 | M18X1.0-6g |
| 15 | D | 52.81 | 34.93 | M22X1.0-6g |
| 17 | E | 56.01 | 38.10 | M25X1.0-6g |
| 19 | F | 58.45 | 41.28 | M28X1.0-6g |
| 21 | G | 62.79 | 44.45 | M31X1.0-6g |
| 23 | H | 65.89 | 47.63 | M34X1.0-6g |
| 25 | J | 68.71 | 50.08 | M37X1.0-6g |

All dimensions for reference only

- III 38999
- II
- I
- SJT
- 26482 Matrix 2
- 83723 III Matrix Pyle
- 5015 Crimp Rear Release Matrix
- 26500 Pyle
- Printed Circuit Board
- EMI Filter Transient
- Fiber Optics
- High Speed Contacts
- Options Others

Easy Steps to build a part number... **Military**

- 1.
- 2.
- 3.
- 4.
- 5.
- 6.
- 7.

| DOD Number Prefix | Spec Sheet Number | Service Class | Shell Size | Insert Arrangement | Lanyard Length Code | Alternate Keying Position |
|-------------------|-------------------|---------------|------------|--------------------|---------------------|---------------------------|
| D38999/ | 29 | F | E | 6 | P | N |

Step 1. DOD Number Prefix

D38999/ designates MIL-DTL-38999, Series III, Tri-Start Connector

Step 2. Select a Specification Sheet Number

| | |
|----|--|
| 29 | Designates Lanyard Release Plug with pin contacts |
| 30 | Designates Lanyard Release Plug with socket contacts |

Step 3. Select a Service Class

| | |
|----------|---|
| F | Designates electroless nickel plated aluminum, optimum EMI shielding effectiveness –65dB@10 GHz specification min., 48 hour salt spray, 200°C |
| W | Designates corrosion resistant olive drab cadmium plate aluminum, 500 hour extended salt spray, EMI –50dB@10 GHz specification min., 175°C |

Step 4. & 5 Insert Availability

| Commercial Basic Part# Shell & Insert Arrg. Code | Shell Size-Insert Arrangement | Military Shell Size-Insert Arrangement | Service Rating | Total Contacts | Contact Size | | | | | | | |
|---|-------------------------------|--|----------------|----------------|--------------|----|----|----|---------|--------|----------|---|
| | | | | | 22D | 20 | 16 | 12 | 12 Coax | 8 Coax | 8 Twinax | |
| 88/91-556508 | 11-2 | * | I | 2 | | | 2 | | | | | |
| 06 | 11-35 | * | M | 13 | 13 | | | | | | | |
| 07 | 11-98 | * | I | 6 | | 6 | | | | | | |
| 10 | 13-4 | * | I | 4 | | | 4 | | | | | |
| 11 | 13-8 | * | I | 8 | | 8 | | | | | | |
| 14 | 13-35 | * | M | 22 | 22 | | | | | | | |
| 13 | 13-98 | * | I | 10 | | 10 | | | | | | |
| 18 | 15-5 | * | II | 5 | | | 5 | | | | | |
| 23 | 15-15 | * | I | 15 | | 14 | 1 | | | | | |
| 22 | 15-18 | * | I | 18 | | 18 | | | | | | |
| 19 | 15-19 | * | I | 19 | | 19 | | | | | | |
| 20 | 15-35 | * | M | 37 | 37 | | | | | | | |
| 21 | 15-97 | * | I | 12 | | 8 | 4 | | | | | |
| 33 | 17-2 | E-2 | M | 39 | 38 | | | | | | | 1 |
| 27 | 17-6 | E-6 | I | 6 | | | | 6 | | | | |
| 28 | 17-8 | E-8 | II | 8 | | | 8 | | | | | |
| 29 | 17-26 | E-26 | I | 26 | | 26 | | | | | | |
| 30 | 17-35 | E-35 | M | 55 | 55 | | | | | | | |
| 31 | 17-99 | E-99 | I | 23 | | 21 | 2 | | | | | |
| 37 | 19-11 | F-11 | II | 11 | | | 11 | | | | | |
| 41 | 19-18 | F-18 | M | 18 | 14 | | | | | | | 4 |
| 38 | 19-28 | F-28 | I | 28 | | 26 | 2 | | | | | |
| 39 | 19-32 | F-32 | I | 32 | | 32 | | | | | | |
| 40 | 19-35 | F-35 | M | 66 | 66 | | | | | | | |
| 47 | 21-11 | G-11 | I | 11 | | | | 11 | | | | |
| 48 | 21-16 | G-16 | II | 16 | | | 16 | | | | | |
| 49 | 21-35 | G-35 | M | 79 | 79 | | | | | | | |
| 51 | 21-39 | G-39 | I | 39 | | 37 | 2 | | | | | |
| 50 | 21-41 | G-41 | I | 41 | | 41 | | | | | | |
| 57 | 23-21 | H-21 | II | 21 | | | 21 | | | | | |
| 58 | 23-35 | H-35 | M | 100 | 100 | | | | | | | |
| 59 | 23-53 | H-53 | I | 53 | | 53 | | | | | | |
| 61 | 23-54 | * | M | 53 | 40 | | 9 | 4 | | | | |
| 60 | 23-55 | * | I | 55 | | 55 | | | | | | |
| 71 | 25-4 | J-4 | I | 56 | | 48 | 8 | | | | | |
| 63 | 25-7 | J-7 | M/Twinax | 99 | 97 | | | | | | 2 | |
| 64 | 25-8 | J-8 | Twinax | 8 | | | | | | | | 8 |
| 66 | 25-19 | J-19 | I | 19 | | | | 19 | | | | |
| 74 | 25-20 | J-20 | N | 30 | | 10 | 13 | | 4 | | | 3 |
| 72 | 25-24 | J-24 | I | 24 | | | 12 | 12 | | | | |
| 67 | 25-29 | J-29 | I | 29 | | | 29 | | | | | |
| 68 | 25-35 | J-35 | M | 128 | 128 | | | | | | | |
| 69 | 25-43 | J-43 | I | 43 | | 23 | 20 | | | | | |
| 65 | 25-46 | * | I | 46 | | 40 | 4 | | | 2* | | |
| 70 | 25-61 | J-61 | I | 61 | | 61 | | | | | | |
| 73 | 25-90 | J-90 | I | 46 | | 40 | 4 | | | | 2 | |

*Not Mil Qualified

Step 6. Military/ Commercial Lanyard Length Code

Table II

| Lanyard Length (in.) ± .236 | Lanyard Length (mm) ± 6.0 | Lanyard Length Code For Part Number |
|-----------------------------|---------------------------|-------------------------------------|
| 4.016 | 102 | A |
| 4.528 | 115 | B |
| 5.000 | 127 | C |
| 5.512 | 140 | D |
| 6.024 | 153 | E |
| 6.535 | 166 | F |
| 7.008 | 178 | G |
| 7.520 | 191 | H |
| 7.992 | 203 | I |
| 8.503 | 216 | J |
| 9.016 | 229 | K |
| 9.528 | 242 | L |
| 10.000 | 254 | M |
| 10.512 | 267 | N |
| 11.024 | 280 | P |
| 11.535 | 293 | R |
| 12.008 | 305 | S |
| 12.520 | 318 | T |
| 13.031 | 331 | U |
| 14.016 | 356 | V |
| 15.000 | 381 | W |
| 16.024 | 407 | X |
| 17.008 | 432 | Y |
| 18.031 | 458 | Z |

Step 7. Military Alternate Keying Position

For alternate positions of connector (to prevent cross-mating) see alternate positioning on page 24. (N indicates normal)

Easy Steps to build a part number... Commercial

FAIL SAFE 88-5565() & 91-5565()

Ordering procedure for example part number 88-556529-EP is shown below:

| 1. | 2. | 3. | 4. | 5. | 6. |
|---------------|-------------------------------|--------------------------------|----------------|---------------------|--|
| Service Class | Connector Type Identification | Shell Size & Insert Arrg. Code | Required Field | Lanyard Length Code | Contact Type/Alternate Keying Position |
| 88 | 5565 | 29 | 0 | E | P |

Step 1. Select a Service Class

| | |
|----|---|
| 88 | Designates corrosion resistant olive drab cadmium plate over nickel, 500 hour extended salt spray, EMI -50dB @ 10 GHz specification min., 175°C |
| 91 | Designates electroless nickel plated aluminum, optimum EMI shielding effectiveness -65dB @ 10 GHz specification min., 48 hour salt spray, 200°C |

These are standard finishes. Consult Amphenol Aerospace, Sidney, NY for other variations.

Step 2. Select a Connector Type Identification

| | |
|------|---|
| 5565 | Designates MIL-DTL-38999, Series III Tri-Start Lanyard Release Plug |
|------|---|

Step 3. Select a Commercial Shell Size & Insert Arrangement Code

MIL-DTL-38999, see insert availability chart on page 38.

Step 4. Required Field

| | |
|---|----------------------------------|
| 0 | The required field is always a 0 |
|---|----------------------------------|

Step 5. Select a Lanyard Length Code

See Table II (to the left) for lanyard length code number.

Step 6. Select a Contact Type/Alternate Keying Position

P designates pin, S designates socket for normal positioning of contacts. When an alternate position of the connector is required to prevent cross-mating, a different letter (other than P or S) is used. See alternate positioning on page 24, then convert to Amphenol Commercial coding by the following chart.

| Pin Contacts | | Socket Contacts | |
|--------------|-----------------|-----------------|-----------------|
| MS Letter | Amphenol letter | MS Letter | Amphenol Letter |
| PN | P (normal) | SN | S (normal) |
| PA | G | SA | H |
| PB | I | SB | J |
| PC | K | SC | L |
| PD | M | SD | N |
| PE | R | SE | T |

- III 38999
- II
- I
- SJT
- Matrix 2 26482
- Matrix Pyle 83723 III
- Crimp Rear Release Matrix 5015
- 26500 Pyle
- Printed Circuit Board
- EMI Filter Transient
- Fiber Optics
- High Speed Contacts
- Options Others

Lanyard Release Plug

PIN CONTACTS ONLY,
SHELL SIZE 25 ONLY

*Part number reference.
To complete, see how to order
page 41.

D38999/31
88-555875/76 } Type 6
91-555875/76 }
88-558518/19 } Type 2
91-558518/19 }
T3W-16B25-XXXX — Type 1

*To order by Commercial Part
numbers consult Amphenol.



TYPE 6



TYPE 2



TYPE 1
(LONGER SHELL)

| Tri-Start Lanyard Separation Forces | | |
|-------------------------------------|---------------------------|----------------------------|
| Shell Size | Straight Plug (lbs. max.) | 15 Degree Pull (lbs. max.) |
| 25 | 90 | 100 |

**INSERT AVAILABILITY
FAIL SAFE D38999/31
FOR MIL-STD-1760**



25-20

Primary Interface Signal Set



25-11

Auxiliary Power Signal Set



Pin Contact Data for MIL-STD-1760

| Insert Arrangement | Service Rating | Total Contacts | Contact | | | |
|--------------------|----------------|----------------|---------|----|-----------|------------|
| | | | 20 | 16 | 12 (Coax) | 8 (Twinax) |
| 25-20 | N | 30 | 10 | 13 | 4 | 3 |

Contacts for 25-20 Pattern

| Shell Size | Arrg. Number | Number of Contacts | Size Contacts | Service Rating | Contact Location | Standard Contacts | |
|------------|--------------|--------------------|------------------------------|----------------|---------------------------------------|-------------------|----------------|
| | | | | | | Pin | Socket |
| 25 | -20 | 3 | 8 | Twinax | A, H, K | M39029/90-529 | M39029/91-530 |
| | | 4 | 12 | Coax | 2,3 | M39029/28-211 | M39029/75-416 |
| | | | | | W, 5 | M39029/102-558 | M39029/103-559 |
| | | 13 | 16 | N | C, D, E, F, J, M, N, P, R, T, U, Y, Z | M39029/58-364 | M39029/56-352 |
| 10 | 20 | N | B, G, L, S, V, X, 1, 4, 6, 7 | M39029/58-363 | M39029/56-351 | | |

| Insert Arrangement | Service Rating | Total Contacts | Contact Size | |
|--------------------|----------------|----------------|--------------|------------|
| | | | 20 | 10 (power) |
| 25-11 | N | 11 | 2 | 9 |

38999
SJT I II III

26482
Matrix 2

83723 III
Matrix Pyle

5015
Crimp Rear Release Matrix

26500 Pyle

Printed
Circuit Board

EMI Filter
Transient

Fiber Optics

High Speed
Contacts

Options
Others

Applications- Lanyard Release Plug

HOW TO ORDER - BY MILITARY PART NUMBER FAIL SAFE D38999/31

Ordering procedure for example part number D38999/31WE20PN1 is shown below:

Easy Steps to build a part number... Military

| 1. | 2. | 3. | 4. | 5. | 6. | 7. | 8. |
|-------------------|-------------------|---------------|---------------------|--------------------|---------------|---------------------------|-------------|
| DOD Number Prefix | Spec Sheet Number | Service Class | Lanyard Length Code | Insert Arrangement | Contact Style | Alternate Keying Position | Type Number |
| D38999/ | 31 | W | E | 20 | P | N | 1 |

1. Select a DOD Number Prefix

| | Designates |
|---------|--|
| D38999/ | MIL-DTL-38999, Series III Tri-Start Connectors |

2. Specification Sheet Number

| | Designates |
|----|--|
| 31 | Designates Lanyard Release Plug for MIL-STD-1760 with pin contacts |

3. Select a Service Class

| | Designates |
|---|--|
| F | Electroless nickel plated aluminum, optimum EMI shielding effectiveness -65dB @ 10 GHz specification min., 48 hour salt spray, 200°C |
| W | Corrosion resistant olive drab cadmium plate aluminum, 500 hour extended salt spray, EMI -50dB @ 10 GHz specification min., 175°C |

4. Select a Lanyard Length Code

| Lanyard Length (in.) ±.236 | Lanyard Length (mm.) ± 6.0 | Lanyard Length Code for Part Number |
|----------------------------|----------------------------|-------------------------------------|
| 6.024 | 153.0 | E |
| 6.535 | 166.0 | F |
| 7.008 | 178.0 | G |
| 7.520 | 191.0 | H |
| 7.992 | 203.0 | I |
| 8.504 | 216.0 | J |
| 9.016 | 229.0 | K |
| 9.528 | 242.0 | L |

5. Select an Insert Arrangement

Only 11 or 20 are available contact arrangement numbers. See page 40.

6. Contact Style – P & A are Valid Options

| | Designates |
|---|---|
| P | Replaces the “no designation” option in the PIN on revision C and earlier revision of the Mil-Spec. |
| A | Designates supplied less contacts. |

7. Alternate Keying Position

| | Designates |
|---|----------------------------------|
| N | Is required for normal position. |

8. Type Number

Type 1, 2 or 6. See drawings on page 40.

For accessories for lanyard release plugs see page 90.

III
II
I
SJT
38999

Matrix 2
26482

Matrix
Pyle
83723 III

Release Matrix
Crimp Rear
5015

Pyle
26500

Printed
Circuit Board

EMI Filter
Transient

Fiber Optics

High Speed
Contacts

Options
Others

D38999 Type Hybrid Breakaway – Series III Crimp, Metal Shell with Composite Operating Sleeve, And Lower Profile Lanyard Release Plug

III

38999
I II

SJT

26482
Matrix 2

83723 III
Matrix Pyle

5015
Crimp Rear
Release Matrix

26500 Pyle

Printed
Circuit Board

EMI Filter
Transient

Fiber Optics

High Speed
Contacts

Options
Others

New Hybrid Lanyard Breakaway Fail Safe connector with a composite thermoplastic outer operating sleeve for greater durability.

This new hybrid breakaway is the breakaway of choice for the Navy F-18 program.

Amphenol's hybrid lanyard design offers greater durability over D38999 aluminum and composite designs because of its ability to handle abuse taken after weapons release. Other advantages include:

- Lower profile compared to full metal breakaway Fail Safe connectors
- Less weight

This Hybrid Breakaway meets the applicable requirements of MIL-DTL-38999/31 including random & sine vibration, ice resistance, fluid immersion and hydrolytic stability tests. (Test reports are available upon request).

Currently the hybrid breakaway is available in shell sizes 25 and 17. It uses standard inserts available for breakaway plugs sizes 25 and 17, and is also available with inserts 25-20 and 25-11 for MIL-STD-1760. Consult Amphenol Aerospace for ordering of the new hybrid breakaway connectors. These hybrid connectors will accommodate the standard backshells for breakaway connectors shown on page 90.



**New Hybrid Lanyard Release Plugs
(Metal inside shells and Composite, lower profile outer sleeves)**

Stores Management Type II, Rail Launch Plugs and receptacles that meet MIL-STD-1760

Amphenol provides a Breakaway Rail Launch connector that is designed for use on aircraft that carry rail launch missiles such as AMRAAM.

These connectors are designed for blindmating of stores on rail launch applications. They consist of a buffer plug and a missile receptacle that meet the specifications of MIL-STD-1760 Stores Management.

Other features and benefits include:

- Designed to MIL-C-83538 specifications
- Bayonet and push pull coupling
- Use standard MIL-DTL-38999 crimp termination with power, coax and twinax contacts also available
- Buffer provides flame barrier
- Buffers are replaceable

Consult Amphenol Aerospace for more information and ordering.



Stores Management Type II Rail Launch Connectors

HD38999 High Density

A connector that has the connections...

The HD38999 family of connectors was designed to work with existing mil-specified 38999 shells. To the end users familiar with standard 38999 connectors, this family of high density connectors will look, feel, and perform just like the mil-qualified connectors. Utilizing an existing mil-qualified 39029 size 23 contact and mil-qualified shells, the new system will be, in many cases, a drop-in connector. Even though the HD38999 has 30% more contacts, it still performs to minimum electrical requirements of standard 38999 connectors.



High Density Interconnects

Goes from 9 to 187 contacts!



- Aluminum
- Composite
- Stainless Steel
- Sealed
- Filtered



For more information e-mail:
hd38999info@amphenol-aao.com
 Specifications, descriptions and illustrations in this literature are as accurate as known at the time of publication, but are subject to change without notice.

Shell Sizes (Front of Pin Insert Shown)



Front of Pin Insert Shown.

| | |
|-----|--------------------------------|
| III | 38999 |
| II | 26482 Matrix 2 |
| I | 83723 III Matrix Pyle |
| SJT | 5015 Crimp Rear Release Matrix |
| | 26500 Pyle |
| | Printed Circuit Board |
| | EMI Filter Transient |
| | Fiber Optics |
| | High Speed Contacts |
| | Options Others |

Amphenol has become the leader in interconnection products through its long history of engineering expertise for product solution solving. New and innovative solutions are under development every day within our highly skilled engineering departments who are teamed with marketing product managers and production specialists. They are always striving to meet new customer requirements in ever changing markets. The teams have a customer-driven approach to produce the end result: quality interconnect products that meet or exceed customer demands.



New/Featured
Breakaway Hybrid, Low Profile Lanyard Release Plug
 Page 42

New Hybrid Lanyard Breakaway Fail Safe Connector with a composite thermoplastic outer operating sleeve for greater durability.

Solution: Navy F-18 program needed a break away plug that would have greater durability in weapons release application.



New/Featured
New HD38999 (High Density, Crimp) Plugs and receptacles
 Page 43, 44

The HD38999 family of connectors was designed to work with existing Mil-specified 38999 shells. The HD38999 has 30% more contacts, it still performs to minimum electrical requirements of standard 38999 connectors.

Solution: 30% more contact density in 38999 Series III Shells



New/Featured
Matrix MIL-DTL-5015 with RADSOK® Contacts
 Page 193

A special design of the Matrix MIL-DTL-5015, Series II connectors has added high amperage with the RADSOK® contacts in the plug instead of standard rear release crimp contacts.

Solution: Higher amperage capability in Matrix MIL-DTL-5015



New/Featured
Filter Connector with High Density Patterns
 Page 289

New High Density Patterns are available in Filter 38999 connectors in standard Mil-Spec or filter length shells. They provide 30% more contact than standard insert arrangement patterns. See page 43 for ordering information.

Solution: Higher contact density and custom stand-off shell designs



New/Featured
ARINC 801 Connectors
 Page 356

Designed for use in Amphenol ARINC 801 fiber optic connectors - manufactured to comply with ARINC 801. Genderless terminus allows for use on both sides of a connector.

Solution: Fiber Optic Termini & Connector that meet ARINC specifications



New/Featured
MT Ferrule Connectors
 Page 359

Amphenol offers a multi-channel circular connector with high density MT fiber optics. High fiber density in a relatively small circular connector package with all the advantages of the MIL-DTL-38999 series III connector.

Solution: Higher Density Fiber Optics in MIL-DTL-38999

III
II
I
SJT
38999

Matrix 2
26482

Matrix Pyle
83723 III

Crimp Rear Release Matrix
5015

Pyle
26500

Printed Circuit Board

EMI Filter Transient

Fiber Optics

High Speed Contacts

Options Others

Series III TV

Series II JT

Series I LJT

SJT

Amphenol Aerospace is the leader in Interconnect solutions and provides companies with a product portfolio of connectors, accessories, cable assemblies and system integration for most applications across various industries. With connectors conforming to Military, Aerospace and Industrial standards in US, Europe and Asia, Amphenol assumes the leadership in meeting the interconnect needs of these market segments.



MIL-DTL-38999 Series III TV Tri-Start

- Backshells Accessories
- Dummy Contacts
- Wire Combs
- Receptacle Protection Cap
- Plug Protection Cap
- Dummy Receptacle
- Cable Clamps
- Contacts-Printed Circuit Board Wire Wrap
- Header Assembly

Application Tools

- Crimp Tools
- Insertion Tools
- Removal Tools

MIL-DTL-38999 Series II JT

- Receptacle Protection Cap
- Plug Protection Cap
- Strain Relief (Solder/Crimp Type)
- Contacts-Printed Circuit Board Wire Wrap
- Header Assembly

Application Tools

- Crimp Tools
- Insertion Tools
- Removal Tools

SJT

- Receptacle Protection Cap
- Plug Protection Cap
- Dummy Receptacle
- Cable Clamps

Application Tools

- Crimp Tools
- Insertion Tools
- Removal Tools

MIL-DTL-38999 Series I LJT

- Receptacle Protection Cap
- Plug Protection Cap
- Dummy Receptacle
- Cable Clamps
- Contacts-Printed Circuit Board Wire Wrap
- Header Assembly

Application Tools

- Crimp Tools
- Insertion Tools
- Removal Tools



III
II
I
SJT
38999

26482
Matrix 2

83723 III
Matrix Pyle

5015
Crimp Rear Release Matrix

26500 Pyle

Printed
Circuit Board

EMI Filter
Transient

Fiber Optics

High Speed
Contacts

Options
Others

Series III TV

Amphenol offers a full range of accessories that are designed to enhance the performance of Amphenol Breakaway connectors.

Low Profile Backshells in shell size 25 with the following features:

- Olive drab cadmium finish
- 90 degree termination
- Low profile design with three heights ranging from 1.010 to 1.660
- Rear access covers to help ease harness assembly and repairability
- Amphenol part numbers: 10-640000-XXX



Backshells are offered for use with Breakaway Fail Safe Connectors in three heights.



Dummy Contacts

- Available in size 12 and size 8
- Provide a cost effective alternative for sealing unused contact cavities
- Size 8 part number: T3-4008-59P
- Size 12 part number: T3-4012-59P

Wire Combs

- Available for the 25-20 insert pattern to help to stabilize and prevent contact side loading
- Amphenol part number: 21-33626-XXX

For information on how to order these accessory products for Breakaway Fail Safe connectors consult Amphenol Aerospace.

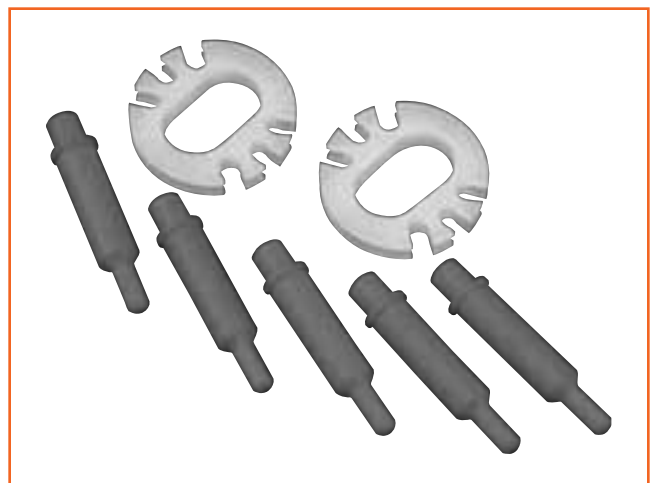

Accessory products for Breakaway Connectors: Dummy Contacts and Wire Combs

- 38999 III
- SJT I II
- 26482 Matrix 2
- 83723 III Pyle Matrix
- 5015 Crimp Rear Release Matrix
- 26500 Pyle
- Printed Circuit Board
- EMI Filter Transient
- Fiber Optics
- High Speed Contacts
- Options Others

MIL-DTL-38999, Series III TV Receptacle Protection Cap

Series III TV



* To complete order number, add shell size and suffix number.
For example, shell size 11 with olive drab cadmium nickel base, **10-552943-119**

Inches

| Shell Size | A Thread Class 2B 0.1P-0.3L-TS | B Dia. Max. | D Dia. +.010 - .000 |
|------------|-----------------------------------|-------------|------------------------|
| 9 | .6250 | .875 | .703 |
| 11 | .7500 | 1.000 | .844 |
| 13 | .8750 | 1.125 | 1.016 |
| 15 | 1.0000 | 1.250 | 1.141 |
| 17 | 1.1875 | 1.438 | 1.266 |
| 19 | 1.2500 | 1.500 | 1.391 |
| 21 | 1.3750 | 1.625 | 1.516 |
| 23 | 1.5000 | 1.750 | 1.641 |
| 25 | 1.6250 | 1.875 | 1.766 |

Millimeters

| Finish | 10-No Suffix |
|----------------------------------|--------------|
| Olive Drab, Cadmium, Nickel base | -XX9 |
| Electroless Nickel | -XXG |

| Shell Size | MS Shell Size Code | B Dia. Max. | D Dia. +.25 -.00 |
|------------|--------------------|-------------|---------------------|
| 9 | A | 22.23 | 17.86 |
| 11 | B | 25.40 | 21.44 |
| 13 | C | 28.58 | 25.81 |
| 15 | D | 31.75 | 28.98 |
| 17 | E | 36.53 | 32.16 |
| 19 | F | 38.10 | 35.33 |
| 21 | G | 41.28 | 38.51 |
| 23 | H | 44.45 | 41.68 |
| 25 | J | 47.63 | 44.86 |

Consult Amphenol Aerospace for availability of stainless steel protection caps.

All dimensions for reference only.
For MS protection caps, see page 95.

III
II
I
SJT
38999

Matrix 2
26482

Matrix
Pyle
83723 III

Crimp Rear
Release Matrix
5015

26500 Pyle

Printed
Circuit Board

EMI Filter
Transient

Fiber Optics

High Speed
Contacts

Options
Others

Series III TV

- 38999 III
- SJT I II
- 26482 Matrix 2
- 83723 III Pyle Matrix
- 5015 Crimp Rear Release Matrix
- 26500 Pyle
- Printed Circuit Board
- EMI Filter Transient
- Fiber Optics
- High Speed Contacts
- Options Others

***10-552944-XXX**



***10-553998-XXX**



* To complete order number, add shell size and suffix number.
For example, shell size 11 with olive drab cadmium nickel base, **10-552944-119**

Inches

| Shell Size | A Thread Class 2B 0.1P-0.3L-TS | D Dia. +.010 -.000 | N Dia. Max. |
|------------|-----------------------------------|-----------------------|----------------|
| 9 | .6250 | .516 | .895 |
| 11 | .7500 | .641 | 1.000 |
| 13 | .8750 | .766 | 1.171 |
| 15 | 1.0000 | .891 | 1.299 |
| 17 | 1.1875 | 1.016 | 1.436 |
| 19 | 1.2500 | 1.141 | 1.543 |
| 21 | 1.3750 | 1.266 | 1.670 |
| 23 | 1.5000 | 1.343 | 1.787 |
| 25 | 1.6250 | 1.516 | 1.914 |

Millimeters

| Finish | 10-No Suffix |
|----------------------------------|--------------|
| Olive Drab, Cadmium, Nickel base | -XX9 |
| Electroless Nickel | -XXG |

| Shell Size | MS Shell Size Code | D Dia. +.25 -.00 | N Dia. Max. |
|------------|--------------------|---------------------|----------------|
| 9 | A | 13.11 | 22.73 |
| 11 | B | 16.28 | 25.40 |
| 13 | C | 19.46 | 29.74 |
| 15 | D | 22.63 | 32.99 |
| 17 | E | 25.81 | 36.47 |
| 19 | F | 28.98 | 39.19 |
| 21 | G | 32.16 | 42.42 |
| 23 | H | 34.11 | 45.39 |
| 25 | J | 38.51 | 48.62 |

Consult Amphenol Aerospace for availability of stainless steel protection caps.

All dimensions for reference only.
For MS protection caps, see page 95.

MIL-DTL-38999, Series III TV Dummy Receptacle

Series III TV

Part number reference.
See note below to complete.

* 10-553974-XXX



* To complete order number, add shell size and suffix number.
For example, shell size 11 with olive drab cadmium nickel base, [10-553974-119](#)

Inches

| Shell Size | MS Shell Size Coded | B Thread 0.1P-0.3L-TS (Plated) | M +.020 - .000 | R ¹ | R ² | S ±.010 | T ±.008 - .006 | W ±.010 | TT ±.008 - .006 |
|------------|---------------------|--------------------------------|----------------|----------------|----------------|---------|----------------|---------|-----------------|
| 9 | A | .6250 | .822 | .719 | .594 | .938 | .128 | .098 | .216 |
| 11 | B | .7500 | .822 | .812 | .719 | 1.031 | .128 | .098 | .194 |
| 13 | C | .8750 | .822 | .906 | .812 | 1.125 | .128 | .098 | .194 |
| 15 | D | 1.0000 | .822 | .969 | .906 | 1.219 | .128 | .098 | .173 |
| 17 | E | 1.1875 | .822 | 1.062 | .969 | 1.312 | .128 | .098 | .194 |
| 19 | F | 1.2500 | .822 | 1.156 | 1.062 | 1.438 | .128 | .098 | .194 |
| 21 | G | 1.3750 | .791 | 1.250 | 1.156 | 1.562 | .128 | .125 | .194 |
| 23 | H | 1.5000 | .791 | 1.375 | 1.250 | 1.688 | .154 | .125 | .242 |
| 25 | J | 1.6250 | .791 | 1.500 | 1.375 | 1.812 | .154 | .125 | .242 |

Millimeters

| Finish | 10-No Suffix |
|----------------------------------|--------------|
| Olive Drab, Cadmium, Nickel base | -XX9 |
| Electroless Nickel | -XXG |

| Shell Size | MS Shell Size Coded | M +.51 - .00 | R ¹ | R ² | S ±.25 | T +.20 - .15 | W ±.25 | TT +.20 - .15 |
|------------|---------------------|--------------|----------------|----------------|--------|--------------|--------|---------------|
| 9 | A | 20.88 | 18.26 | 15.09 | 23.83 | 3.25 | 2.49 | 5.49 |
| 11 | B | 20.88 | 20.62 | 18.26 | 26.19 | 3.25 | 2.49 | 4.93 |
| 13 | C | 20.88 | 23.01 | 20.62 | 28.58 | 3.25 | 2.49 | 4.93 |
| 15 | D | 20.88 | 24.61 | 23.01 | 30.96 | 3.25 | 2.49 | 4.93 |
| 17 | E | 20.88 | 26.97 | 24.61 | 33.32 | 3.25 | 2.49 | 4.93 |
| 19 | F | 20.88 | 29.36 | 26.97 | 36.53 | 3.25 | 2.49 | 4.93 |
| 21 | G | 20.09 | 31.75 | 29.36 | 39.67 | 3.25 | 3.18 | 4.93 |
| 23 | H | 20.09 | 34.93 | 31.75 | 42.88 | 3.91 | 3.18 | 6.15 |
| 25 | J | 20.09 | 38.10 | 34.93 | 46.02 | 3.91 | 3.18 | 6.15 |

All dimensions for reference only

Designates true position dimensioning

- III 38999
- II
- I
- SJT
- 26482 Matrix 2
- 83723 III Matrix Pyle
- 5015 Crimp Rear Release Matrix
- 26500 Pyle
- Printed Circuit Board
- EMI Filter Transient
- Fiber Optics
- High Speed Contacts
- Options Others

Series III TV

38999

SJT I II III

26482

Matrix 2

83723 III

Matrix Pyle

5015

Crimp Rear Release Matrix

26500 Pyle

Printed Circuit Board

EMI Filter Transient

Fiber Optics

High Speed Contacts

Options Others

Straight Style

*10-552681-XXX metal coupling



90 Degree Elbow Style

*10-552682-XXX metal coupling



* To complete order number, see suffix chart below. Examples:
Clamp with metal coupling nut for shell size 11 with olive drab cadmium nickel base, 10-552681-119.

Inches

| Shell Size | MS Shell Size Code | F ¹ Min. Dia. Cable | F ² Max. Dia. Cable | L Max. | U Max. | FF Dia. Max. | KK Dia. Max. | LL Max. |
|------------|--------------------|--------------------------------|--------------------------------|--------|--------|--------------|--------------|---------|
| 9 | A | .094 | .203 | 1.431 | .656 | .347 | .629 | 1.015 |
| 11 | B | .141 | .250 | 1.431 | .688 | .394 | .756 | 1.062 |
| 13 | C | .172 | .323 | 1.431 | .750 | .467 | .883 | 1.125 |
| 15 | D | .203 | .422 | 1.431 | .859 | .566 | 1.011 | 1.328 |
| 17 | E | .234 | .500 | 1.431 | .937 | .644 | 1.138 | 1.392 |
| 19 | F | .265 | .562 | 1.431 | 1.000 | .706 | 1.265 | 1.453 |
| 21 | G | .297 | .625 | 1.492 | 1.062 | .769 | 1.393 | 1.609 |
| 23 | H | .328 | .703 | 1.492 | 1.141 | .847 | 1.488 | 1.656 |
| 25 | J | .359 | .765 | 1.492 | 1.203 | .909 | 1.616 | 1.719 |

Millimeters

| Finish | 10-No Suffix |
|---------------------------------|--------------|
| Olive Drab, Cadmium Nickel Base | -XX9 |
| Electroless Nickel | -XXG |

| Shell Size | MS Shell Size Code | F ¹ Min. Dia. Cable | F ² Max. Dia. Cable | L Max. | U Max. | V Thread Metric | FF Dia. Max. | KK Dia. Max. | LL Max. |
|------------|--------------------|--------------------------------|--------------------------------|--------|--------|-----------------|--------------|--------------|---------|
| 9 | A | 2.39 | 5.16 | 36.35 | 16.66 | M12X1-6H | 8.81 | 15.98 | 25.78 |
| 11 | B | 3.58 | 6.35 | 36.35 | 17.48 | M15X1-6H | 10.01 | 19.20 | 26.97 |
| 13 | C | 4.37 | 8.20 | 36.35 | 19.05 | M18X1-6H | 11.86 | 22.43 | 28.58 |
| 15 | D | 5.16 | 10.72 | 36.35 | 21.82 | M22X1-6H | 14.38 | 25.68 | 33.73 |
| 17 | E | 5.94 | 12.70 | 36.35 | 23.80 | M25X1-6H | 16.36 | 28.91 | 35.36 |
| 19 | F | 6.73 | 14.27 | 36.35 | 25.40 | M28X1-6H | 17.93 | 32.13 | 36.91 |
| 21 | G | 7.54 | 15.88 | 37.90 | 26.97 | M31X1-6H | 19.53 | 35.38 | 40.87 |
| 23 | H | 8.83 | 17.86 | 37.90 | 28.98 | M34X1-6H | 21.51 | 37.80 | 42.06 |
| 25 | J | 9.12 | 19.43 | 37.90 | 30.56 | M37X1-6H | 23.09 | 41.05 | 43.66 |

All dimensions for reference only.

STANDARD 500 CYCLE CONTACTS FOR TV AND CTV, P & S

| Contact Size | TV/CTV Pins | | TV/CTV Sockets | |
|--------------|-----------------|-------------|----------------|-------------|
| | Military No. | Supersedes | Military No. | Supersedes |
| 8 (Coax)* | M39029/60-367 | MS27536 | M39029/59-366 | MS27535 |
| 8 (Power) | Contact Factory | NA | NA | NA |
| 8 (Twinax)** | M39029/90-529 | N/A | M39029/91-530 | N/A |
| 10 (Power) | M39029/58-528 | N/A | M39029/56-527 | N/A |
| 12 | M39029/58-365 | MS27493-12 | M39029/56-353 | MS27490-12 |
| 16 | M39029/58-364 | MS27493-16 | M39029/56-352 | MS27490-16 |
| 20 | M39029/58-363 | MS27493-20 | M39029/56-351 | MS27490-20 |
| 22D | M39029/58-360 | MS27493-22D | M39029/56-348 | MS27490-22D |
| 4 | N/A | N/A | N/A | N/A |
| 0 | N/A | N/A | N/A | N/A |

Above part numbers include standard 500 cycle finish designation - gold plating over suitable underplate in accordance with SAE AS39029. For other finish variations, consult Amphenol.

*For use with RG180B/U and RG195A/U cable. For other size 8 coax or optional sizes 12 and 16 coax contacts available for use in MIL-DTL-38999 Series III connectors, see the High Speed Contact section of this catalog consult Amphenol, Sidney, NY

** For use with M17/M176-00002 cable. For other contact options available for use in Tri-Start connectors, (wire wrap, thermocouple, fiber optic) consult Amphenol.

1500 CYCLE CONTACTS FOR CTV, CLASSES H & J

| Contact Size | CTV Pins | | | CTV Sockets | | |
|--------------|----------------|----------------|------------|----------------|----------------|------------|
| | Commercial No. | Military No. | Supersedes | Commercial No. | Military No. | Supersedes |
| 12 | 10-597072-2X | M39029/107-623 | - | 10-597073-2X | M39029/106-617 | - |
| 16 | 10-597068-2X | M39029/107-622 | - | 10-597069-2X | M39029/106-616 | - |
| 20 | 10-597064-2X | M39029/107-621 | - | 10-597065-2X | M39029/106-615 | - |
| 22D | 10-597058-3X | M39029/107-620 | - | 10-597061-2X | M39029/106-614 | - |

PLASTIC PROTECTION CAPS

| Shell Size | Plug | Receptacle |
|------------|-------------|-------------|
| 9 | 10-70506-14 | 10-70500-10 |
| 11 | 10-70506-16 | 10-70500-12 |
| 13 | 10-70500-18 | 10-70500-14 |
| 15 | 10-70500-20 | 10-70500-16 |
| 17 | 10-70500-22 | 10-70500-19 |
| 19 | 10-70500-24 | 10-70500-20 |
| 21 | 10-70524-1 | 10-70500-22 |
| 23 | 10-70506-28 | 10-70500-24 |
| 25 | 10-70500-28 | 10-70524-1 |

MS METAL PROTECTION CAPS

| Shell Size | MS Shell Size Code | MS Plug Protection Cap | MS Receptacle Protection Cap |
|------------|--------------------|------------------------|------------------------------|
| 9 | A | D38999/32W9X* | D38999/33W9X* |
| 11 | B | D38999/32W11X* | D38999/33W11X* |
| 13 | C | D38999/32W13X* | D38999/33W13X* |
| 15 | D | D38999/32W15X* | D38999/33W15X* |
| 17 | E | D38999/32W17X* | D38999/33W17X* |
| 19 | F | D38999/32W19X* | D38999/33W19X* |
| 21 | G | D38999/32W21X* | D38999/33W21X* |
| 23 | H | D38999/32W23X* | D38999/33W23X* |
| 25 | J | D38999/32W25X* | D38999/33W25X* |

* To complete order number, replace X with applicable letter as follows:
 R - designates eyelet type
 N - designates washer type

MS metal protection caps are supplied with service class W which designates corrosion resistant olive drab cadmium plate aluminum. Consult Amphenol, Sidney, NY for more detailed information on ordering MS Metal protection caps.

SEALING PLUGS

| Contact Size | Commercial No. | Military No. |
|--------------|----------------|--------------|
| 8 (Coax) | 10-482099-8 | N/A |
| 8 (Twinax) | T3-4008-59P | N/A |
| 8 (Power) | 10-405996-83 | MS27488-8-3 |
| 10 (Power) | T3-4010-59P | M85049/81-10 |
| 12 | 10-405996-122 | MS27488-12-2 |
| 16 | 10-405996-162 | MS27488-16-2 |
| 20 | 10-405996-202 | MS27488-20-2 |
| 22D | 10-405996-222 | MS27488-22-2 |
| 4 | 10-405996-43 | MS27488-4-3 |
| 0 | 10-405996-03 | MS27488-0-3 |

III
II
I
SJT
38999

Matrix 2
26482

Matrix
Pyle
83723 III

Crimp Rear
Release Matrix
5015

Pyle
26500

Printed
Circuit Board

EMI Filter
Transient

Fiber Optics

High Speed
Contacts

Options
Others

for Flex Print or PC Board

Series III TV

Series II JT

Series I LJT

**Mounts to all MIL-DTL-38999 and
*MIL-DTL-26482 Connectors**

Termination of PC tail connectors to a flex print or a printed circuit board represents a major cost in the manufacturing process for users. When adding flex or printed circuit board assemblies to an expensive filter or filter/transient protection connector, the total cost of a failed solder joint, a bent pin, or an unanticipated electrical failure becomes prohibitive. The universal header assembly from Amphenol provides for easy separation of the connector from the board on these occasions. The header assembly is comprised of a short pin/socket contact. The tail end of the contact is soldered to the through hole of the flex or printed circuit board. The socket is embedded in the insulator, making electrical contact with the printed circuit tail of the connector.



Headers provide easy separation of the connector from the PC board.

Header Assemblies Provide Cost Savings

Incorporation of the header assembly provides the user with time and cost saving potentials. These header assemblies can be vapor phase or wave soldered to flex or printed circuit boards prior to the receipt of the EMI/EMP connector. Headers can be installed to standard connectors, allowing for electrical testing that would adversely affect the sensitive diodes, MOV's or capacitors in the EMI/EMP connectors. Expensive connector assemblies can be easily removed from and reattached to the header assembly as the manufacturing process dictates.

Mounting Applications

Shell modifications are recommended, but are not necessary. The header assembly can be attached to connectors with standard flange placement or directly to the circuit board. The ideal application would involve either a single flange moved all the way to the rear of the connector or a double flange. Cinch nuts can be installed in either flange to allow easier mounting to the panel or the header assembly. The forward flange would mount the connector to the panel; the rear flange would be used to mount the header assembly. Various types of captivated or loose attaching screws can be utilized for unique applications.

Amphenol universal headers are slotted to allow mounting to all series of MIL-DTL-38999 or MIL-DTL-26482* connectors without special alterations. They are of similar dimension as the flange of the mounting connector and are approximately .185 inches (4.70 mm) thick.

* For information on Header Assemblies for MIL-DTL-26482 connector consult Amphenol, Sidney NY.

Cylindrical Configuration

- 3 PCB stickout dimensions are available.
- Size 22 contacts use .175 thick headers
- Size 16 to 20 contacts use .195 thick headers
- Consult Amphenol, Sidney NY for additional configurations.
- Headers for cylindrical connectors accommodate up to 128 pins. For MIL-DTL-38999 insert arrangements chart see pages 4-7 and insert drawings on pages 8-14.

Mounting to Rectangular ARINC Connectors

- Headers for ARINC connector arrangements accommodate up to 150 pins
- Consult Amphenol, Sidney, NY for ARINC configurations and detailed dimensions.

Materials

- Body is molded or machined from FR-4.
- Electrical engagement areas of the header contact are plated with .00003 inches minimum of gold over .00005 inches minimum of nickel.

See drawing of standard header on next page.

38999
SJT

26482
Matrix 2

83723 III
Matrix Pyle

5015
Crimp Rear Release Matrix

26500 Pyle

Printed
Circuit Board

EMI Filter
Transient

Fiber Optics

High Speed
Contacts

Options
Others

MIL-DTL-38999, Series III TV, II JT, I LJT

Universal "Header Assembly" for Flex Print or PC Board Connectors



The drawing below shows the standard header assembly for use with MIL-DTL-38999 connectors. Consult Amphenol Aerospace, Sidney NY for drawings of headers for ARINC configurations.

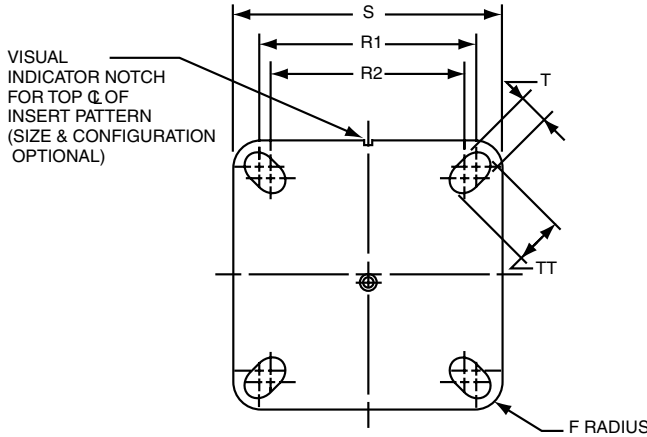

| Assembly Part Number | Shell Size | F Radius | G ± .005 | S ± .005 | T + .008 - .006 | R1 TP† | R2 TP† | TT + .008 - .006 |
|----------------------|------------|----------|----------|----------|-----------------|--------|--------|------------------|
| 21-904008-XX() | 8/9 | .094 | | .938 | .128 | .719 | .594 | .216 |
| 21-904010-XX() | 10/11 | .094 | | 1.031 | .128 | .812 | .719 | .194 |
| 21-904012-XX() | 12/13 | .094 | | 1.125 | .128 | .906 | .812 | .194 |
| 21-904014-XX() | 14/15 | .125 | | 1.219 | .128 | .969 | .906 | .173 |
| 21-904016-XX() | 16/17 | .125 | | 1.312 | .128 | 1.062 | .969 | .194 |
| 21-904018-XX() | 18/19 | .125 | | 1.438 | .128 | 1.156 | 1.062 | .194 |
| 21-904020-XX() | 20/21 | .125 | | 1.562 | .128 | 1.250 | 1.156 | .194 |
| 21-904022-XX() | 22/23 | .125 | | 1.688 | .154 | 1.375 | 1.250 | .242 |
| 21-904024-XX() | 24/25 | .125 | | 1.812 | .154 | 1.500 | 1.375 | .242 |

See Suffix Chart

Assemblies containing Size 22 contacts only: .175
Assemblies containing Size 16 or 20 contacts: .195

† TP designates true position dimensioning.

NOTE:
Size 22 accepts .018 to .022 dia. PCB tails.
Size 16 accepts .048 to .064 dia. PCB tails.
Size 20 accepts .037 to .043 dia. PCB tails.

HOW TO ORDER INFORMATION

For Header Assembly with MIL-DTL-38999 Connectors

Use coded number as follows:

21-9040 XX - XX X

Designates Amphenol Header Assembly _____
Shell size designation for MIL-DTL-38999 Series I, II, III and IV see Suffix chart. _____
Arrangement number - See MIL-STD-1560 or MIL-STD-1669. See insert availability charts on pages 4-7. _____
Contact PCB Stickout designation See Suffix chart. _____

For how to order information on adapters to be used with ARINC connectors, consult Amphenol, Sidney NY.

ASSEMBLY NUMBER SUFFIX CHART

| Shell Size Designation* | Arrangement Number Suffix*** | Contact PCB Stickout** | |
|-------------------------|---|------------------------|-------------------|
| | | Suffix | B ± .015 Stickout |
| 08 | Insert Arrangement Suffix from MIL-STD-1560 or MIL-STD-1669 | 1 | .120 |
| 10 | | 2 | .185 |
| 12 | | 3 | .270 |
| 14 | | | |
| 16 | | | |
| 18 | | | |
| 20 | | | |
| 24 | | | |

*Shell size designation for MIL-DTL-38999 Series I, II, III and IV and MIL-DTL-26482 Series 1 and 2.

Examples: Shell size 9 use 08. Shell size 25 use 24.

** Size 22 contacts available in all 3 stickout lengths. Size 16 and 20 contacts available only in .185 and .270 lengths.

*** Insert arrangement 14-97 and 15-97 are not available at this time. Consult Amphenol, Sidney NY for information.



| | | | |
|---------------|--------------|--------------|-----|
| Series III TV | Series II JT | Series I LJT | SJT |
|---------------|--------------|--------------|-----|

The following data includes information pertaining to the application tools which have been established for crimping, inserting, and removing contacts incorporated in the TV, CTV and MIL-DTL-38999 Series III connectors. For additional information on coax, twinax and triax contact tools see High Speed Contact section of this catalog. All crimping tools included are the "full cycling" type and when

used as specified in the installation instructions (L-624 and L-844) covering the TV, CTV and MS series connectors, will provide reliable crimped wire to contact terminations. There is a possibility of additional crimping tools other than those included being available at present or in the future for this specific application.

CRIMPING TOOLS

| Contact Size/Type | Crimping Tool | Turret Die or Positioner |
|--|---|---|
| 12 Pin and Socket | M22520/1-01 | M22520/1-04 |
| 16 Pin and Socket | M22520/1-01 M22520/7-01 | M22520/1-04 M22520/7-04 |
| 20 Pin and Socket | M22520/1-01 M22520/2-01 M22520/7-01 | M22520/1-04 M22520/2-10 M22520/7-08 |
| 22, 22D, 22M Pin | M22520/2-01 M22520/7-01 | M22520/2-09 M22520/7-07 |
| 22, 22D, 22M Socket Series I, III | M22520/2-01 M22520/7-01 | M22520/2-07 M22520/7-05 |
| 22D Socket Series II | M22520/2-01 M22520/7-01 | M22520/2-06 M22520/7-06 |
| 8 Twinax Center Pin and Socket | M22520/2-01 | M22520/2-37 |
| 8 Twinax Intermediate Outer Pin & Socket | M22520/5-01 | M22520/5-200 |

| Contact Size/Type | Crimping Tool | Turret Die or Positioner |
|---------------------------------|---------------|----------------------------|
| 8 Coaxial Inner Pin and Socket | M22520/2-01 | M22520/2-31 |
| 8 Coaxial Outer Pin and Socket | M22520/5-01 | M22520/5-05 Die Closure B |
| | M22520/5-01 | M22520/5-41 Die Closure B |
| | M22520/10-01 | M22520/10-07 Die Closure B |
| 16 Coaxial Inner Pin and Socket | M22520/2-01 | M22520/2-35 |
| 16 Coaxial Outer Pin and Socket | M22520/4-01 | M22520/4-02 |
| 12 Coaxial Inner Pin and Socket | M22520/2-01 | M22520/2-34 |
| 12 Coaxial Outer Pin and Socket | M22520/31-01 | M22520/31-02 |
| 10 (Power) | TP-201423 | |

Where 2 or 3 tools are listed for a contact size, only one tool and its die or positioner are required to crimp the contact. The above crimping tools and positioners are available from the approved tool manufacturer.

INSERTION TOOLS

| Use with Contact Size | Plastic Tools | | Metal Tools | | | |
|-----------------------|----------------|------------------|----------------|---------------------|-----------------------------------|--------|
| | MS Part Number | Color | Angle Type | | Straight Type Commercial Part No. | Color |
| | | | MS Part No. | Commercial Part No. | | |
| 10 (Power) | M81969/14-05* | Gray / (White) | M81969/8-11 | † | † | Green |
| 12 | M81969/14-04* | Yellow / (White) | M81969/8-09 | 11-8674-12 | 11-8794-12 | Yellow |
| 16 | M81969/14-03* | Blue / (White) | M81969/8-07 | 11-8674-16 | 11-8794-16 | Blue |
| 20 | M81969/14-10* | Red / (Orange) | M81969/8-05 | 11-8674-20 | 11-8794-20 | Red |
| 22 | M81969/14-09 | Brown/White | M81969/8-03 | 11-8674-22 | 11-8794-22 | Brown |
| 22D, 22M | M81969/14-01* | Green / (White) | M81969/8-01 | 11-8674-24 | 11-8794-24 | Black |
| 8 Coaxial | None Required | | | | | |
| 8 Twinax | None | | M81969/46-06** | None | | Red |

REMOVAL TOOLS

| Use with Contact Size | Plastic Tools | | | Metal Tools | | | |
|-----------------------|----------------|------------------|--|----------------|---------------------|-----------------------------------|----------------|
| | MS Part Number | Color | For Unwired Contacts Commercial Part No. | Angle Type | | Straight Type Commercial Part No. | Color |
| | | | | MS Part No. | Commercial Part No. | | |
| 10 (Power) | M81969/14-05* | (Gray) / White | † | M81969/8-12 | † | † | Green / White |
| 12 | M81969/14-04* | (Yellow) / White | 11-10050-11 | M81969/8-10 | 11-8675-12 | 11-8795-12 | Yellow / White |
| 16 | M81969/14-03* | (Blue) / White | 11-10050-10 | M81969/8-08 | 11-8675-16 | 11-8795-16 | Blue / White |
| 20 | M81969/14-10* | (Orange) / Red | 11-10050-9 | M81969/8-06 | 11-8675-20 | 11-8795-20 | Red / Orange |
| 22 | M81969/14-09* | (Brown)/White | 11-10050-8 | M81969/8-04 | 11-8675-22 | 11-8795-22 | Brown/White |
| 22D, 22M | M81969/14-01* | (Green) / White | 11-10050-7 | M81969/8-02 | 11-8675-24 | 11-8795-24 | Green / White |
| 8 Coaxial | M81969/14-12 | Green | None | None | 11-9170 | DRK264-8†† | N/A |
| 8 Twinax | M81969/14-12 | Green | None | M81969/46-12** | 11-9170 | N/A | N/A |

The M81969/8, 11-8674, 11-8675, and 11-8794 metal contact insertion and removal tools will accommodate wires having the maximum outside diameter as follows: Contact size 12: dia. is .155, size 16: dia. is .109, size 20: dia. is .077, size 22D: dia. is .050. When wire diameters exceed those specified, the plastic tools must be used.

* Double end insertion/removal tool.

** Twinax insertion tools are available only in a straight type, metal version.

† To be determined.

†† Contact Daniels Manufacturing Co. for availability.

38999 III II I SJT
 26482 Matrix 2
 83723 III Pyle Matrix
 5015 Crimp Rear Release Matrix
 26500 Pyle
 Printed Circuit Board
 EMI Filter Transient
 Fiber Optics
 High Speed Contacts
 Options Others