

PC TERMINAL OPTION
PL812705X SHOWN

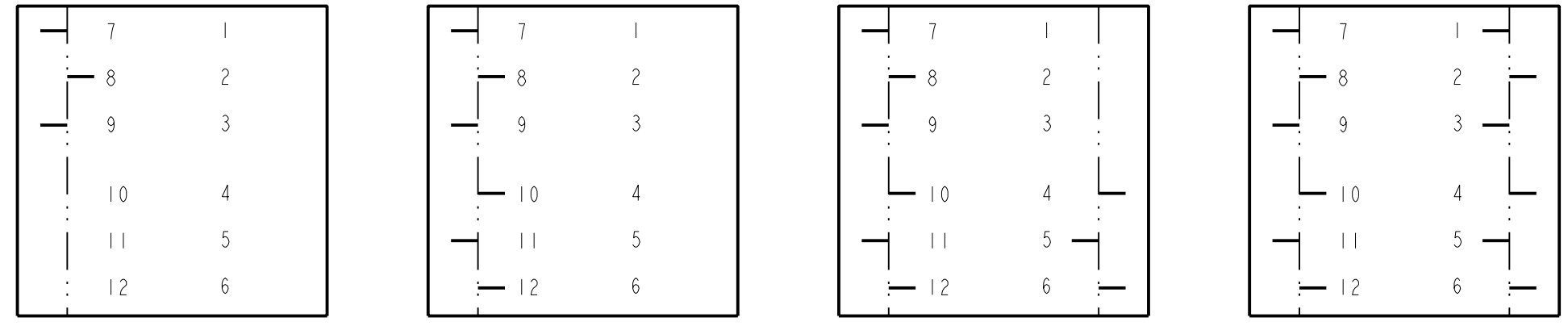

P.C. TERMINAL LOCATION

PL SERIES PL					
	LAMP & SWITCH HOUSING COLOR	CIRCUITRY	ACTION	PUSHBUTTON COLOR	RoHS COMPLIANT

- 1 - SINGLE LAMP, BLACK HOUSING
 - 2 - TWIN LAMP, BLACK HOUSING
 - 3 - NON-ILLUMINATED, BLACK HOUSING
 - 4 - SINGLE LAMP, GRAY HOUSING
 - 5 - TWIN LAMP, GRAY HOUSING
 - 6 - NON-ILLUMINATED, GRAY HOUSING
 - 7 - SINGLE LAMP, BLACK HOUSING (PC TERMINALS)
 - 8 - TWIN LAMP, BLACK HOUSING (PC TERMINALS)
- 03 - 1C (SPDT)
 - 06 - 2C (2PDT)
 - 09 - 3C (3PDT)
 - 12 - 4C (4PDT)
 - 23 - 1C (8A)(SPDT)
 - 26 - 2C (8A)(2PDT)
 - 29 - 3C (8A)(3PDT)
 - 32 - 4C (8A)(4PDT)
- 2 - MOMENTARY
 - 7 - PUSH-LOCK/PUSH-RELEASE
- 00 - NONE
 - 01 - RED
 - 03 - GREEN
 - 04 - BLUE
 - 05 - WHITE
 - 08 - YELLOW
 - 12 - CLEAR
 - 13 - AMBER

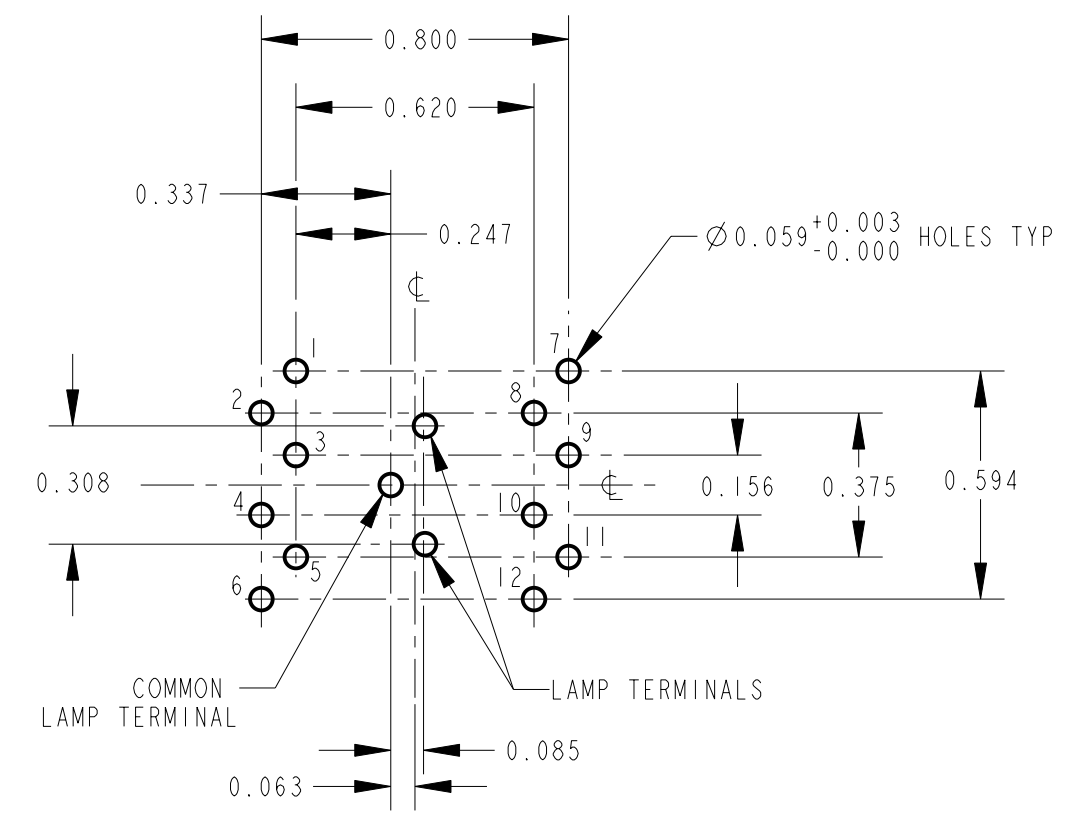

RECOMMENDED PCB LAYOUT
COMPONENT SIDE

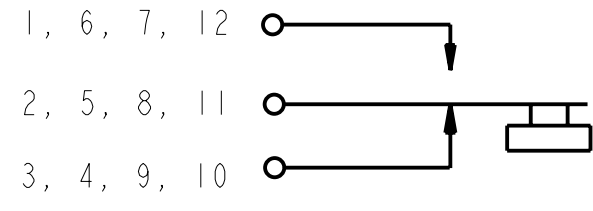

SCHEMATIC

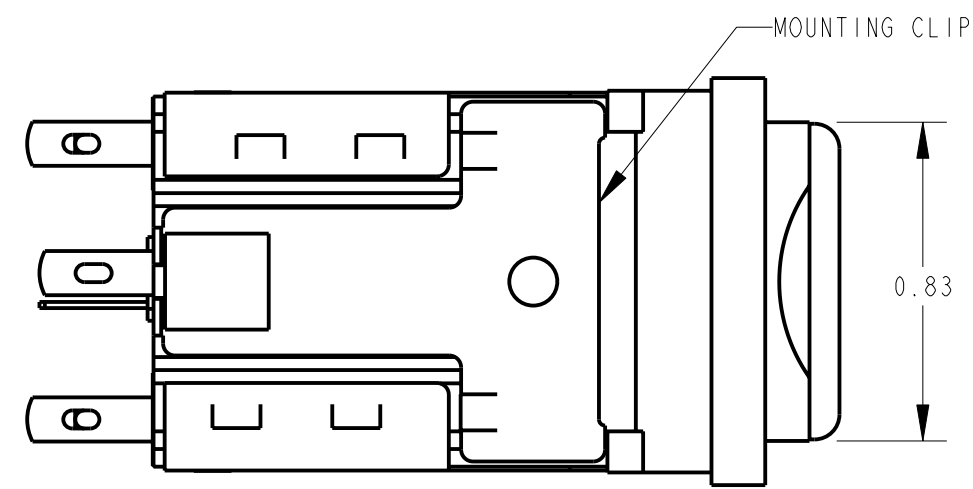

SOLDER TERMINAL OPTION
PL212705X SHOWN

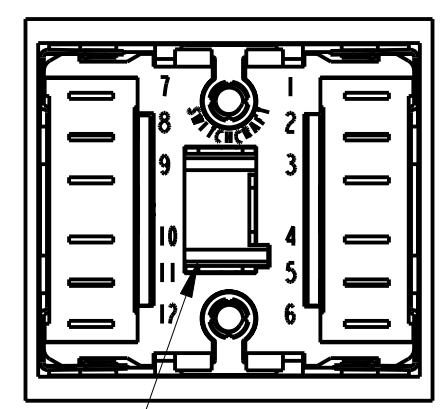

SOLDER LUGS ALSO ACCEPT 0.110 FASTON TERMINALS

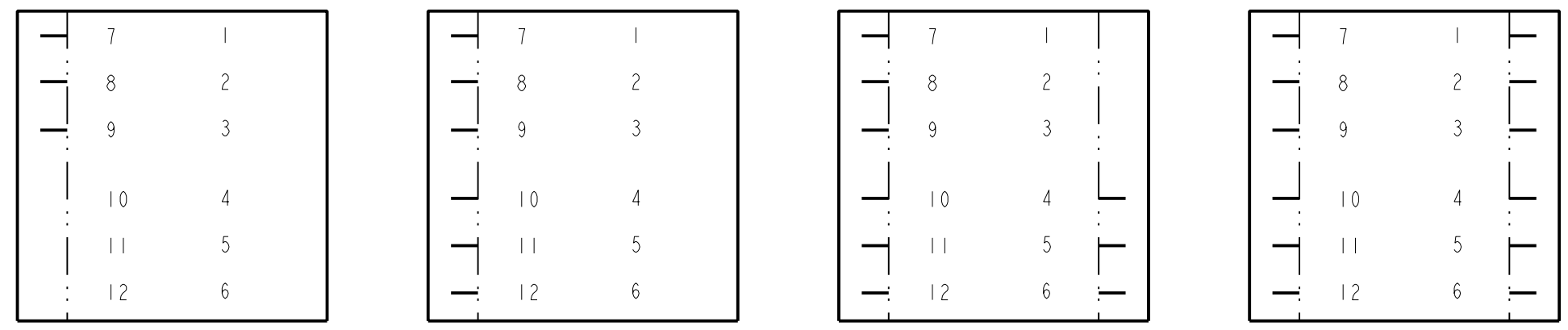

SOLDER TERMINAL LOCATION

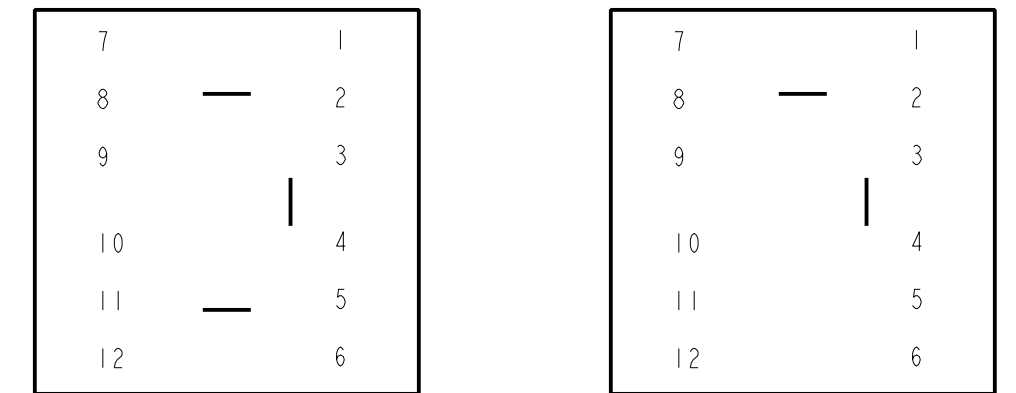

DETAIL 'A'
LAMP TERMINAL LOCATION

NOTES:

- MATERIALS:
HOUSING - THERMOPLASTIC, SEE TABLE FOR COLOR
BUTTON - THERMOPLASTIC, SEE TABLE FOR COLOR
TERMINALS - COPPER ALLOY, SILVER PLATED
LAMP SOCKET - PLATED COPPER ALLOY
- MOUNTIN HOLE - 1.000 x 0.875 RECTANGLE.
0.125 MAX PANEL THICKNESS.
- BUTTON TRAVEL - 0.22 WITH 0.09 FALL BACK ON PUSH-LOCK/PUSH-RELEASE.
- ACCEPTS STANDARD T 1-3/4 FLANGE BASE LAMPS (NOT SUPPLIED).
- THIS PRODUCT IS RoHS COMPLIANT.

CUSTOMER DRAWING

<p>★ STAR SYMBOL DENOTES CRITICAL DIMENSION</p> <p>UNLESS OTHERWISE SPECIFIED</p> <p>1. ALL DIMENSIONS IN INCHES - TWO PLACE DECIMALS ±0.01 - THREE PLACE DECIMALS ±0.005 - ANGLES ±1° - ALL DIA. CONCENTRIC WITHIN 0.005 T.I.R.</p> <p>2. FEATURES ON THE SAME CENTERLINE MUST BE ALIGNED WITHIN ±0.002</p> <p>3. REMOVE ALL BURRS</p>				<p>THIS DRAWING DESCRIBES A DESIGN CONSIDERED PROPRIETARY IN NATURE, DEVELOPED AND MANUFACTURED BY SWITCHCRAFT INC. AND IS RELEASED ON A CONFIDENTIAL BASIS FOR IDENTIFICATION PURPOSES ONLY.</p>					
SIZE		WIDTH		MULT		LBS/M		TEMPER	
FINISH				MATERIAL				SPEC No.	
FIRST USED ON				SCALE				2:1	
DATE DRAWN	BY	CHKD	APVD	<p>Switchcraft</p>					
31-Mar-09	TJK	4-8-09	4-8-09	SHEET OF					
NAME				PART No.				REV	
PUSH-LITE SWITCHES, RoHS				PL..._2...X SERIES				A	
PL..._7...X SERIES									