

**PC TERMINAL OPTION**  
PL812705X SHOWN

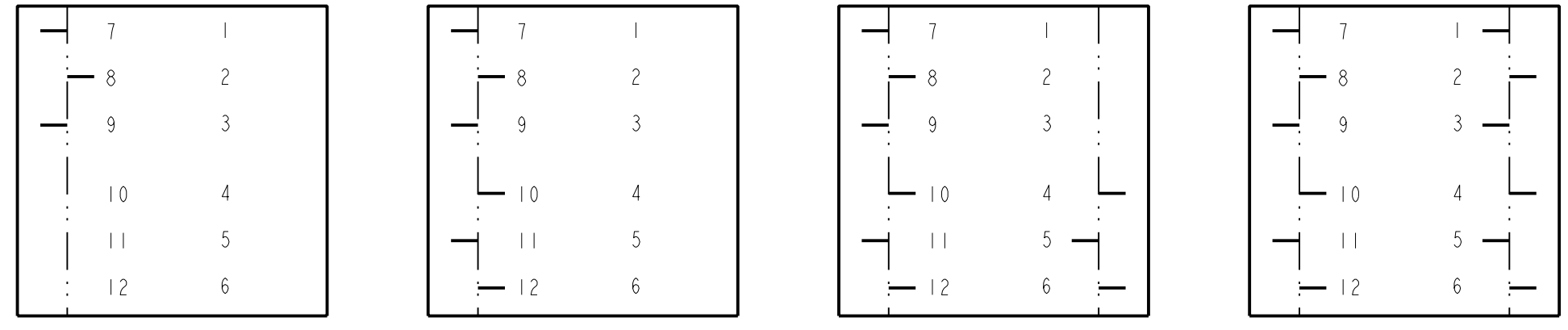

**P.C. TERMINAL LOCATION**

<b>PL</b> SERIES PL					
<b>LAMP &amp; SWITCH HOUSING COLOR</b>	<b>CIRCUITRY</b>	<b>ACTION</b>	<b>PUSHBUTTON COLOR</b>	<b>RoHS COMPLIANT</b>	

- 1 - SINGLE LAMP, BLACK HOUSING
  - 2 - TWIN LAMP, BLACK HOUSING
  - 3 - NON-ILLUMINATED, BLACK HOUSING
  - 4 - SINGLE LAMP, GRAY HOUSING
  - 5 - TWIN LAMP, GRAY HOUSING
  - 6 - NON-ILLUMINATED, GRAY HOUSING
  - 7 - SINGLE LAMP, BLACK HOUSING (PC TERMINALS)
  - 8 - TWIN LAMP, BLACK HOUSING (PC TERMINALS)
- 03 - 1C (SPDT)
  - 06 - 2C (2PDT)
  - 09 - 3C (3PDT)
  - 12 - 4C (4PDT)
  - 23 - 1C (8A)(SPDT)
  - 26 - 2C (8A)(2PDT)
  - 29 - 3C (8A)(3PDT)
  - 32 - 4C (8A)(4PDT)
- 2 - MOMENTARY
  - 7 - PUSH-LOCK/PUSH-RELEASE
- 00 - NONE
  - 01 - RED
  - 03 - GREEN
  - 04 - BLUE
  - 05 - WHITE
  - 08 - YELLOW
  - 12 - CLEAR
  - 13 - AMBER

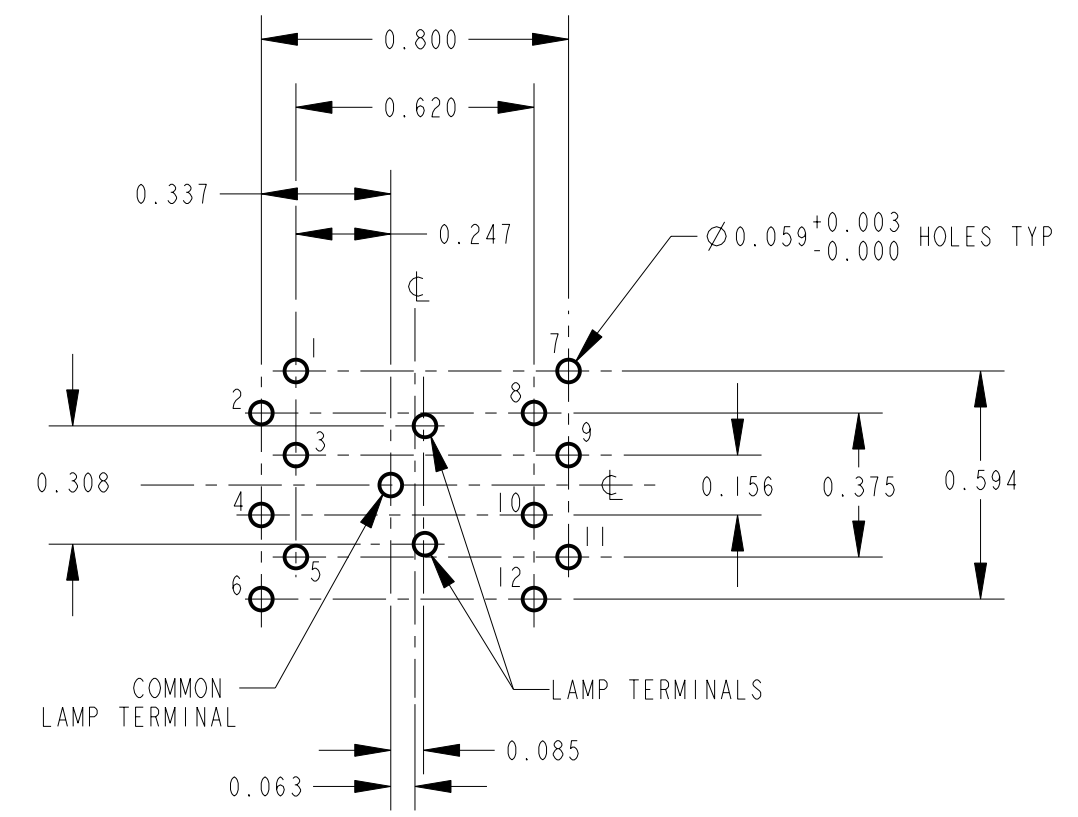

**RECOMMENDED PCB LAYOUT**  
COMPONENT SIDE

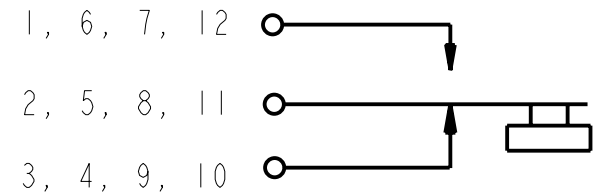

**SCHEMATIC**

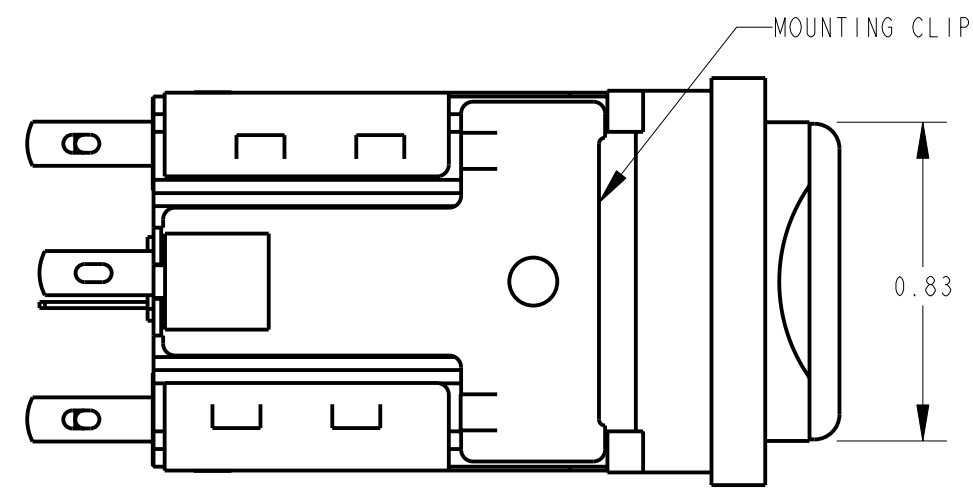

**SOLDER TERMINAL OPTION**  
PL212705X SHOWN

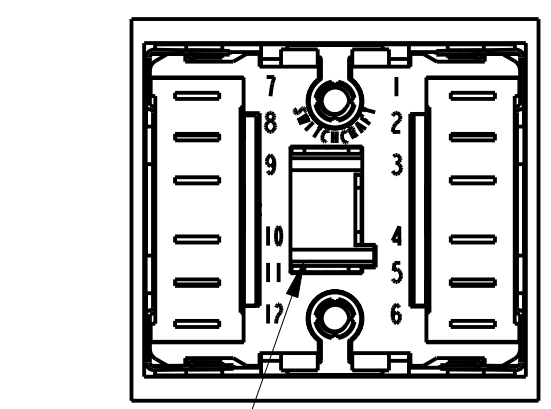

SOLDER LUGS ALSO ACCEPT 0.110 FASTON TERMINALS

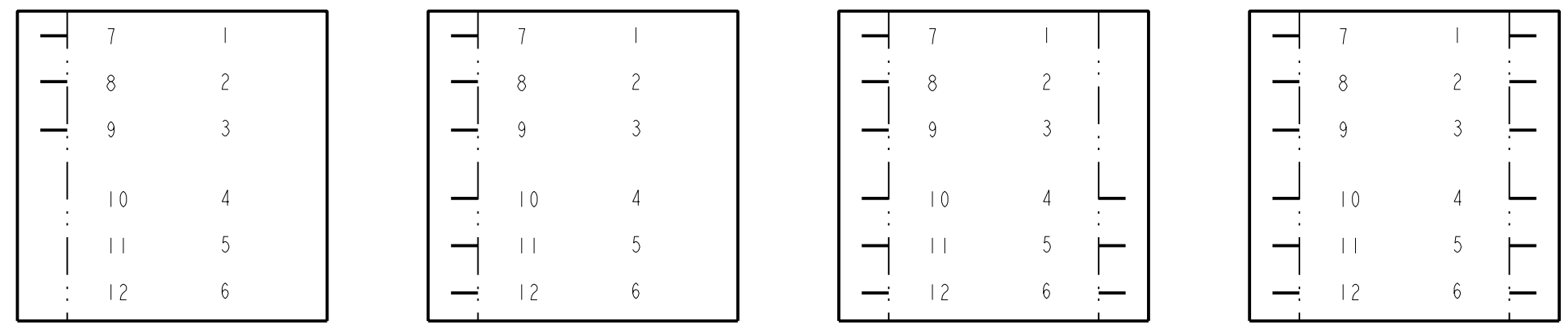

**SOLDER TERMINAL LOCATION**

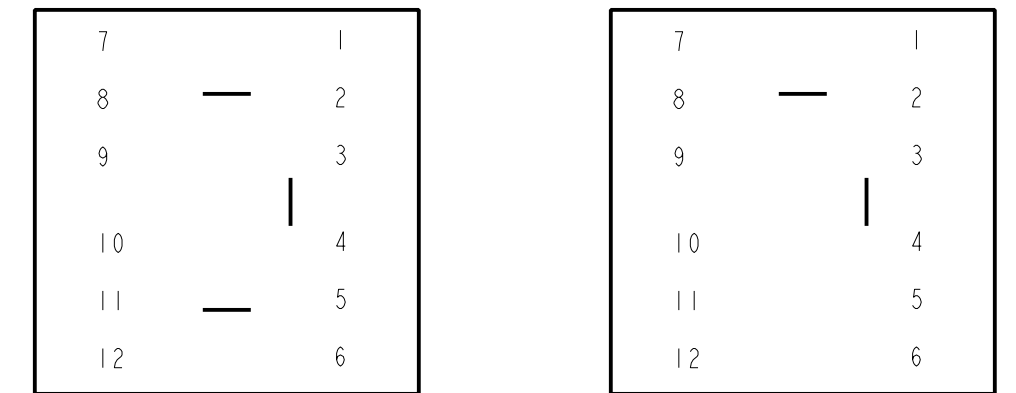

**DETAIL 'A'**  
LAMP TERMINAL LOCATION

**NOTES:**

- MATERIALS:  
HOUSING - THERMOPLASTIC, SEE TABLE FOR COLOR  
BUTTON - THERMOPLASTIC, SEE TABLE FOR COLOR  
TERMINALS - COPPER ALLOY, SILVER PLATED  
LAMP SOCKET - PLATED COPPER ALLOY
- MOUNTIN HOLE - 1.000 x 0.875 RECTANGLE.  
0.125 MAX PANEL THICKNESS.
- BUTTON TRAVEL - 0.22 WITH 0.09 FALL BACK ON PUSH-LOCK/PUSH-RELEASE.
- ACCEPTS STANDARD T 1-3/4 FLANGE BASE LAMPS (NOT SUPPLIED).
- THIS PRODUCT IS RoHS COMPLIANT.

**CUSTOMER DRAWING**

<p>★ STAR SYMBOL DENOTES CRITICAL DIMENSION</p> <p>UNLESS OTHERWISE SPECIFIED</p> <p>1. ALL DIMENSIONS IN INCHES - TWO PLACE DECIMALS ±0.01 - THREE PLACE DECIMALS ±0.005 - ANGLES ±1° - ALL DIA. CONCENTRIC WITHIN 0.005 T.I.R.</p> <p>2. FEATURES ON THE SAME CENTERLINE MUST BE ALIGNED WITHIN ±0.002</p> <p>3. REMOVE ALL BURRS</p> <p>DO NOT SCALE DRAWING</p>					<p>THIS DRAWING DESCRIBES A DESIGN CONSIDERED PROPRIETARY IN NATURE, DEVELOPED AND MANUFACTURED BY SWITCHCRAFT INC. AND IS RELEASED ON A CONFIDENTIAL BASIS FOR IDENTIFICATION PURPOSES ONLY.</p> <table border="1"> <tr> <td>SIZE</td> <td>WIDTH</td> <td>MULT</td> <td>LBS/M</td> <td>TEMPER</td> </tr> <tr> <td colspan="5">FINISH</td> </tr> <tr> <td colspan="5">SPEC No.</td> </tr> <tr> <td colspan="3">FIRST USED ON</td> <td colspan="2">SCALE 2:1</td> </tr> <tr> <td>DATE DRAWN</td> <td>BY</td> <td>CHKD</td> <td>APVD</td> <td></td> </tr> <tr> <td>31-Mar-09</td> <td>TJK</td> <td>4-8-09</td> <td>4-8-09</td> <td></td> </tr> <tr> <td colspan="5">NAME</td> </tr> <tr> <td colspan="5">PUSH-LITE SWITCHES, RoHS</td> </tr> </table>					SIZE	WIDTH	MULT	LBS/M	TEMPER	FINISH					SPEC No.					FIRST USED ON			SCALE 2:1		DATE DRAWN	BY	CHKD	APVD		31-Mar-09	TJK	4-8-09	4-8-09		NAME					PUSH-LITE SWITCHES, RoHS				
SIZE	WIDTH	MULT	LBS/M	TEMPER																																													
FINISH																																																	
SPEC No.																																																	
FIRST USED ON			SCALE 2:1																																														
DATE DRAWN	BY	CHKD	APVD																																														
31-Mar-09	TJK	4-8-09	4-8-09																																														
NAME																																																	
PUSH-LITE SWITCHES, RoHS																																																	
<table border="1"> <tr> <td>REV</td> <td>ECO NUMBER</td> <td>DATE</td> <td>BY</td> <td>APVD</td> </tr> <tr> <td></td> <td></td> <td></td> <td></td> <td></td> </tr> </table>					REV	ECO NUMBER	DATE	BY	APVD						<p><b>Switchcraft</b></p> <p>SHEET   OF  </p> <p>PART No. PL___2__X SERIES PL___7__X SERIES</p> <p>REV A</p>																																		
REV	ECO NUMBER	DATE	BY	APVD																																													