

SWITCHCRAFT CABLE CONNECTOR ASSEMBLY INSTRUCTIONS

**STEP 1**  
FEED THE END OF THE CABLE THROUGH THE BOOT AND CABLE CLAMP HOUSING IN THE ORDER AND POSITION SHOWN.

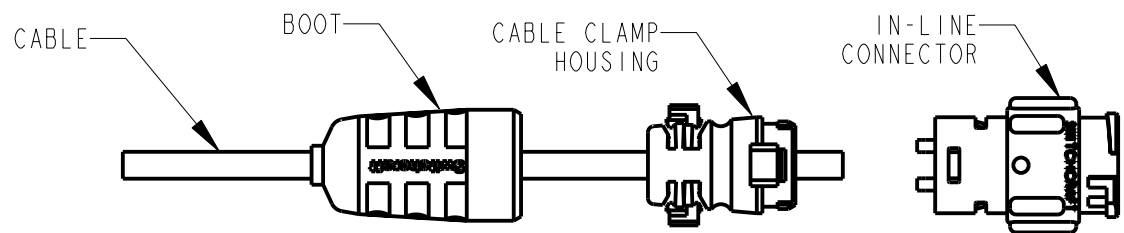

**STEP 2**  
STRIP CABLE AS SHOWN AND BEGIN SOLDERING CONDUCTORS TO PINS. STARTING WITH CONTACT NO. 1 NEXT TO THE "NOTCH" AND FOLLOW WITH THE REMAINING CONDUCTORS CLOCKWISE WITH NO. 6 OR NO. 8 CONDUCTOR IN THE CENTER.

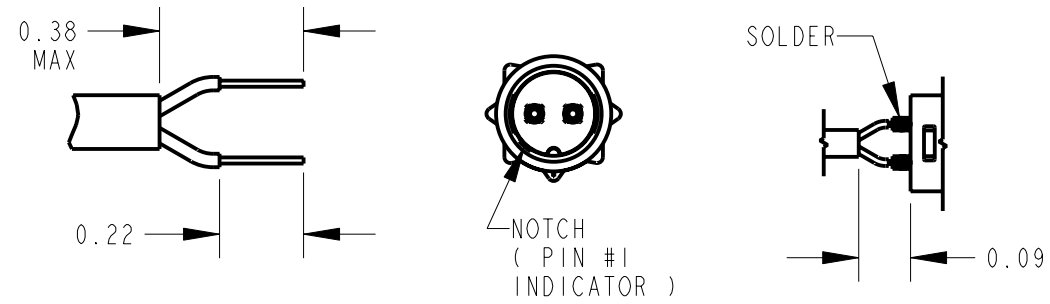

**STEP 3**  
PUSH THE CABLE CLAMP HOUSING FORWARD UNTIL IT LOCKS INTO THE CONNECTOR BODY AND SNAP THE TWO CLAMPS INTO IT'S COMPARTMENTS.

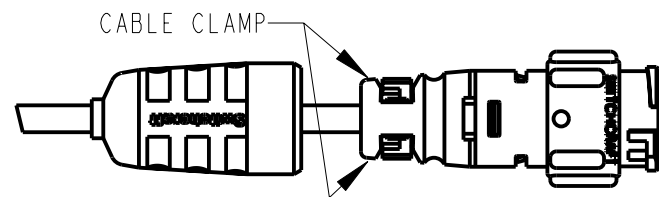

**STEP 4**  
PUSH THE BOOT ALL THE WAY FORWARD TO SEAT TIGHTLY ONTO THE CABLE CLAMP HOUSING.

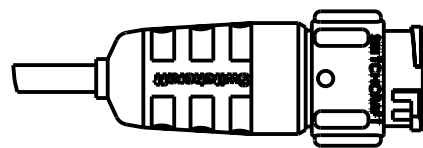

SPECIFICATIONS

**MECHANICAL:**  
SHOCK: MIL-STD 202 METHOD 213B, COND. K.  
VIBRATION: MIL-STD 202 METHOD 201  
LIFE: 300 INSERTION/WITHDRAWAL CYCLES (MINIMUM)

**ELECTRICAL**  
DIELECTRIC WITHSTANDING VOLTAGE: 1,000 VAC  
INSULATION RESISTANCE: 100 MEGOHMS (MIN) AT 77°F  
CONTACT RESISTANCE: 5.0 MILLOHMS MAX.  
CURRENT RATING: 7.5 AMPS (#20 CONTACT)  
6.5 AMPS (7 & 8 PIN #20 CONTACT)  
13.0 AMPS (#16 CONTACT)

**ENVIRONMENTAL**  
TEMPERATURE LIMITS: -40°C TO +65°C (NON-OPERATING)  
MOISTURE RESISTANCE: MIL-STD 202 METHOD 106F  
INSULATION RESISTANCE: MIL-STD 202 METHOD 302, COND. B  
THERMAL SHOCK: MIL-STD 202 METHOD 107G  
SALT SPRAY: MIL-STD 202 METHOD 101D, COND. B  
WATER TIGHTNESS TEST: U.S. COAST GUARD CFR 46 PART 110.20

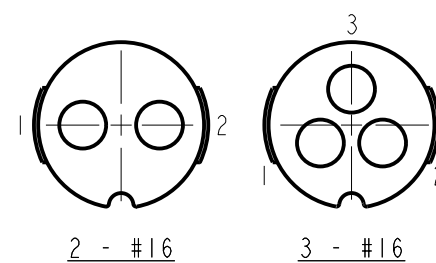
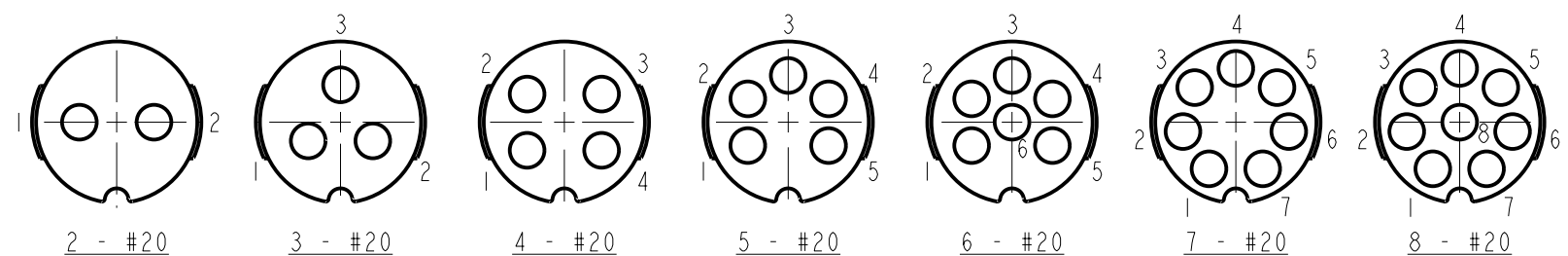

CONTACT ARRANGEMENTS

SHOWN ARE REAR VIEWS OF MALE INLINE CONNECTORS

**MATERIALS:**  
IN-LINE CONNECTOR SHELL, CONTACT LOCKING DISK, AND CABLE CLAMP ASSEMBLY: THERMOPLASTIC POLYMER GLASS FIBER, FLAME RETARDANT

REAR BOOT AND CONNECTOR SHELL INTERIOR: THERMOPLASTIC RUBBER

CONTACTS: COPPER BASE ALLOY GOLD-PLATED OVER NICKEL UNDERPLATE

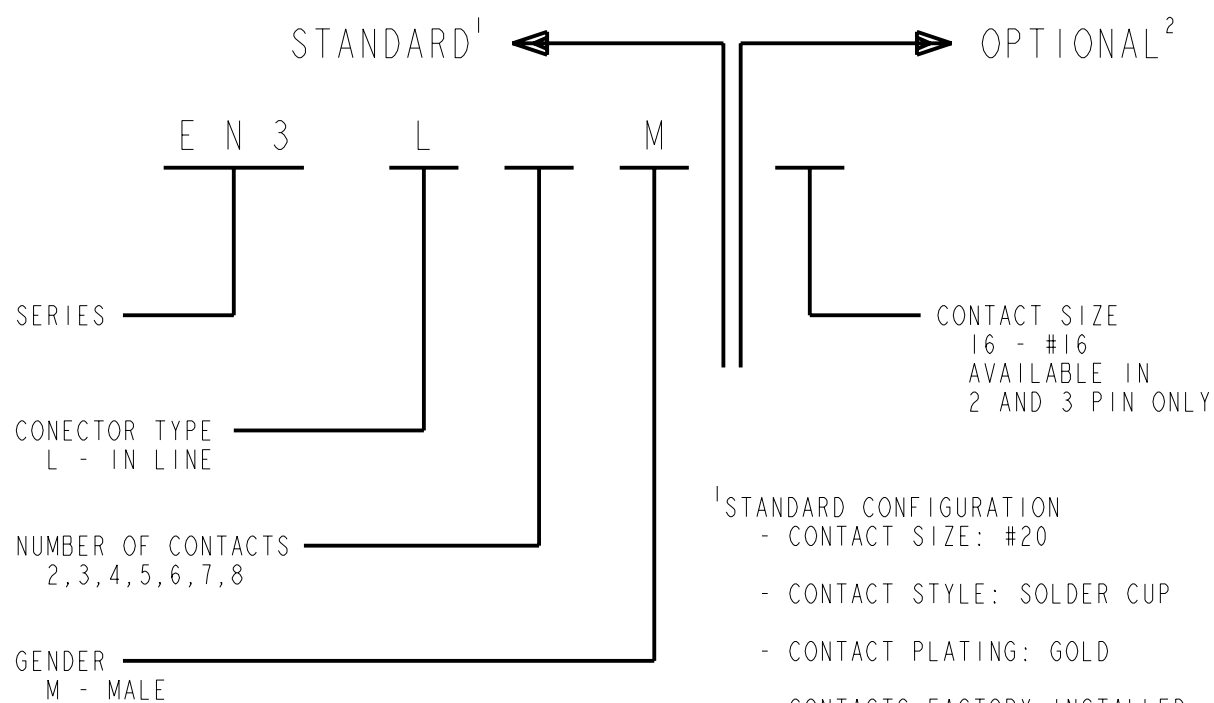

<sup>1</sup>STANDARD CONFIGURATION  
- CONTACT SIZE: #20

<sup>2</sup>OPTIONAL CONFIGURATION  
- LEAVE BLANK FOR STANDARD CONFIGURATION

- CONTACT STYLE: SOLDER CUP
- CONTACT PLATING: GOLD
- CONTACTS FACTORY INSTALLED
- PACKAGED IN BULK

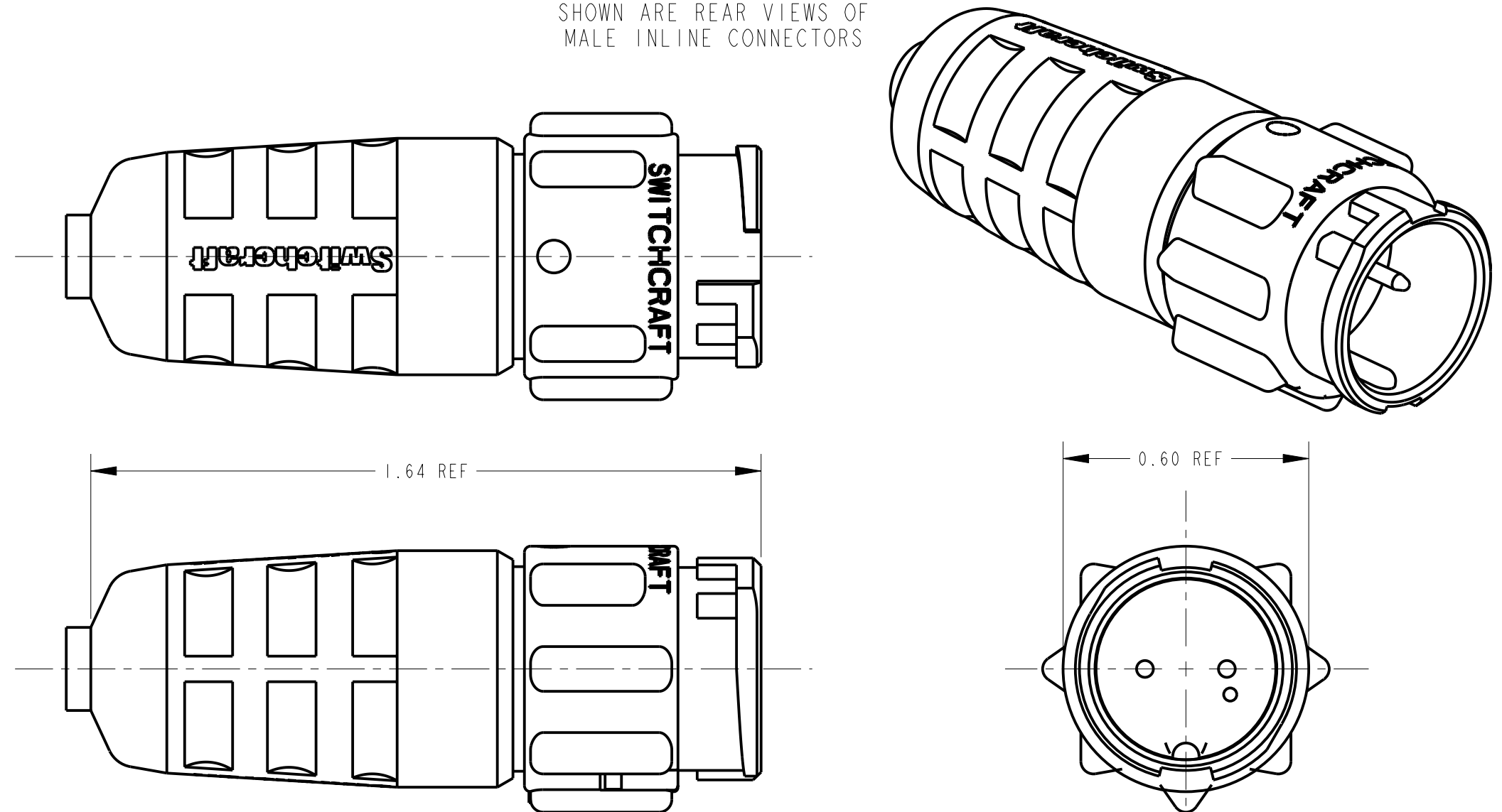

CUSTOMER DRAWING

★ STAR SYMBOL DENOTES CRITICAL DIMENSION				THIS DRAWING DESCRIBES A DESIGN CONSIDERED PROPRIETARY IN NATURE, DEVELOPED AND MANUFACTURED BY SWITCHCRAFT INC. AND IS RELEASED ON A CONFIDENTIAL BASIS FOR IDENTIFICATION PURPOSES ONLY.				
UNLESS OTHERWISE SPECIFIED				SIZE	WIDTH	MULT	LBS/M	TEMPER
1. ALL DIMENSIONS IN INCHES				FINISH				MATERIAL SPEC No.
- TWO PLACE DECIMALS ±0.01				FIRST USED ON				SCALE 2:1
- THREE PLACE DECIMALS ±0.005				DATE DRAWN	BY	CHKD	APVD	<b>Switchcraft</b>
- ANGLES ±1°				22-May-95	SG	5-22-95	5-25-95	
- ALL DIA. CONCENTRIC WITHIN 0.005 T.I.R.				NAME				SHEET   OF
2. FEATURES ON THE SAME CENTERLINE MUST BE ALIGNED WITHIN ±0.002				MALE CONNECTOR				REV B
3. REMOVE ALL BURRS				PART No. EN3L_M				
DO NOT SCALE DRAWING								
REVISIONS								