

STEP 1
 STRIP CABLE AS SHOWN.
 FEED THE END OF THE CABLE THROUGH THE BOOT, CABLE CLAMP HOUSING, AND COUPLING RING IN THE ORDER AND POSITION SHOWN. CRIMP CONDUCTOR TO CONTACT. CONTACT #1 TO BE NEXT TO NOTCH.

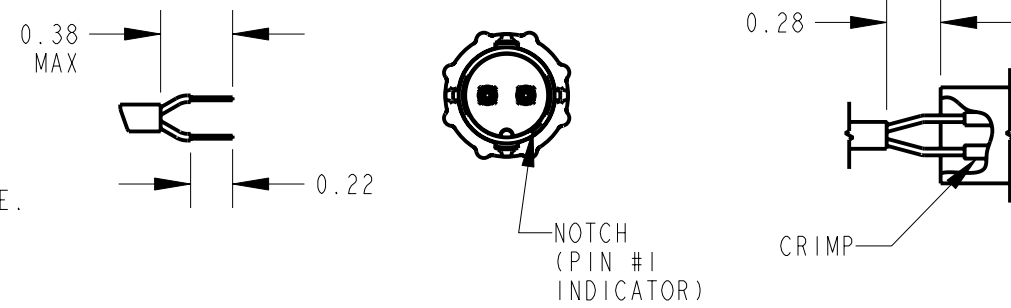

**REMAINING CONTACTS TO BE PLACED COUNTER CLOCKWISE.

STEP 2
 ALIGN COUPLING RING'S TABS WITH CORD CONNECTOR'S SIDE NOTCHES AND PUSH THE COUPLING RING ONTO CORD CONNECTOR.

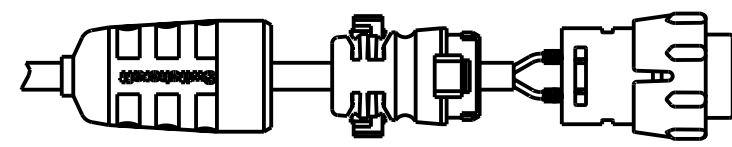

STEP 3
 PUSH THE CABLE CLAMP HOUSING FORWARD UNTIL IT LOCKS INTO THE CONNECTOR BODY AND SNAP THE TWO CLAMPS INTO ITS COMPARTMENTS.

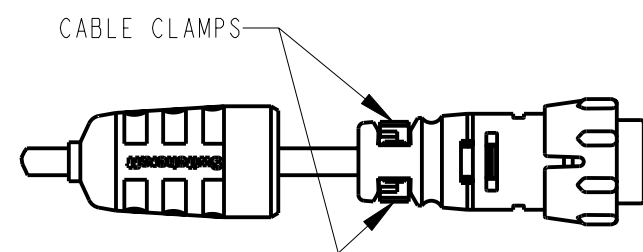

STEP 4
 PUSH THE BOOT ALL THE WAY FORWARD TO SEAT TIGHTLY ONTO THE CABLE CLAMP HOUSING.

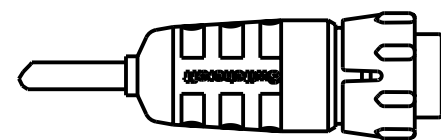

SPECIFICATIONS

MECHANICAL:
 SHOCK: MIL-STD 202 METHOD 213B, COND. K.
 VIBRATION: MIL-STD 202 METHOD 201
 LIFE: 300 INSERTION/WITHDRAWAL CYCLES (MINIMUM)

ELECTRICAL
 DIELECTRIC WITHSTANDING VOLTAGE: 1,000 VAC
 INSULATION RESISTANCE: 100 MEGOHMS (MIN) AT 77°F
 CONTACT RESISTANCE: 5.0 MILLOHMS MAX.
 CURRENT RATING: 7.5 AMPS (#20 CONTACT)
 6.5 AMPS (7 & 8 PIN #20 CONTACT)
 13.0 AMPS (#16 CONTACT)

ENVIRONMENTAL
 TEMPERATURE LIMITS: -40°C TO +65°C (NON-OPERATING)
 MOISTURE RESISTANCE: MIL-STD 202 METHOD 106F
 INSULATION RESISTANCE: MIL-STD 202 METHOD 302, COND. B
 THERMAL SHOCK: MIL-STD 202 METHOD 107G
 SALT SPRAY: MIL-STD 202 METHOD 101D, COND. B
 WATER TIGHTNESS TEST: U.S. COAST GUARD CFR 46 PART 110.20

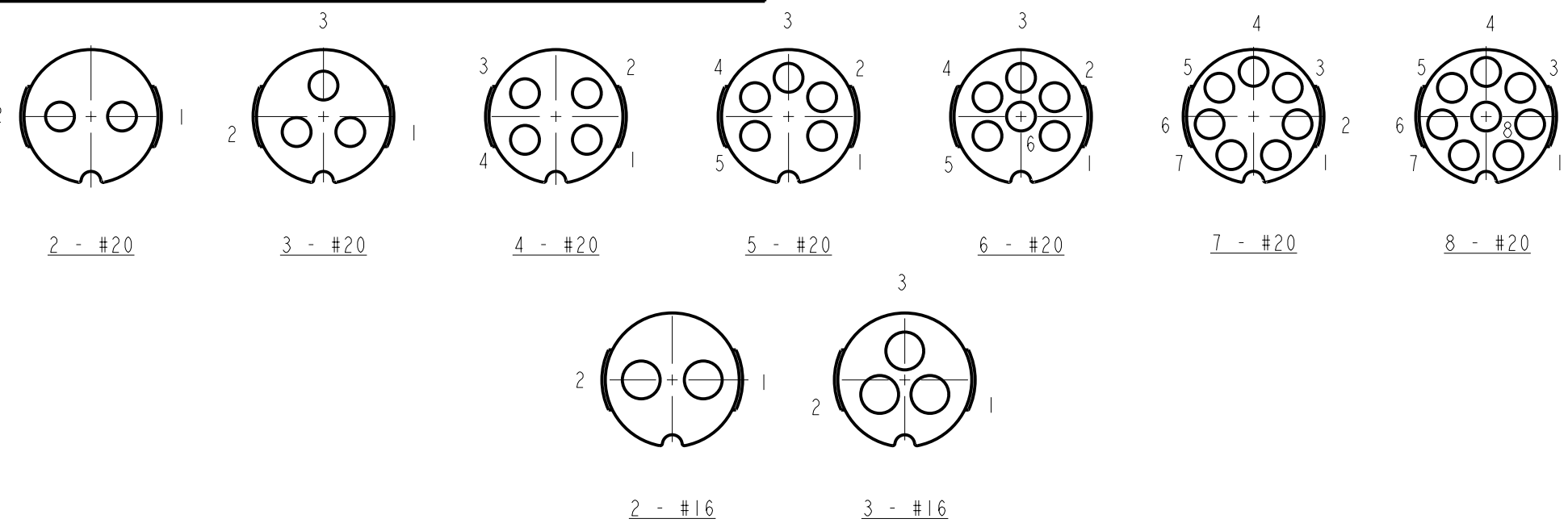

CONTACT ARRANGEMENTS

SHOWN ARE REAR VIEWS OF FEMALE CORD CONNECTORS

MATERIALS:
 CORD CONNECTOR SHELL, CONTACT LOCKING DISK, COUPLING RING AND CABLE CLAMP ASSEMBLY:
 THERMOPLASTIC POLYMER GLASS FIBER, FLAME RETARDANT
 REAR BOOT AND CONNECTOR SHELL INTERIOR:
 THERMOPLASTIC RUBBER
 CONTACTS: COPPER BASE ALLOY GOLD-PLATED OVER NICKEL UNDERPLATE

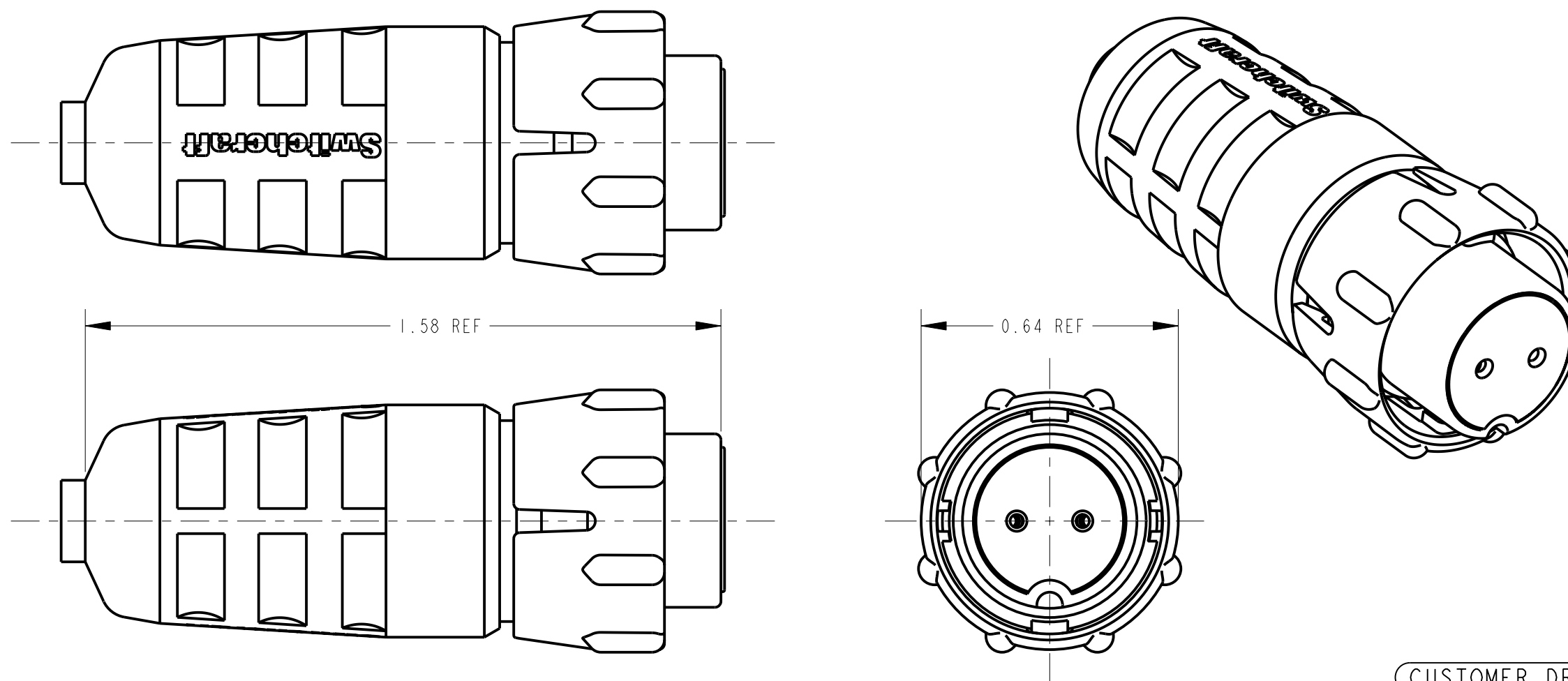

CUSTOMER DRAWING

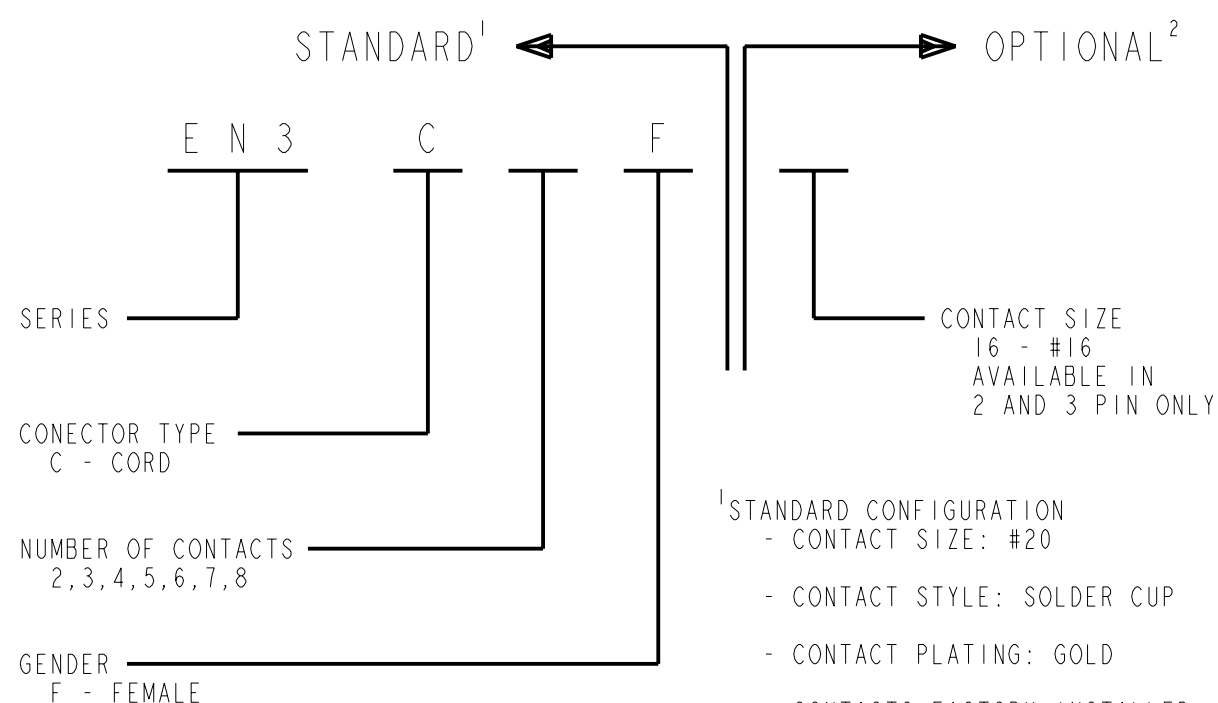

¹STANDARD CONFIGURATION
 - CONTACT SIZE: #20
 - CONTACT STYLE: SOLDER CUP
 - CONTACT PLATING: GOLD
 - CONTACTS FACTORY INSTALLED
 - PACKAGED IN BULK

²OPTIONAL CONFIGURATION
 - LEAVE BLANK FOR STANDARD CONFIGURATION

REV	ECO NUMBER	DATE	BY	APVD
G	22232	6-7-98	SG	RB
F	21282	2-5-97	SG	RB
E	20897	2-5-97	SG	RB
REVISIONS				

★ STAR SYMBOL DENOTES CRITICAL DIMENSION
 UNLESS OTHERWISE SPECIFIED
 1. ALL DIMENSIONS IN INCHES
 - TWO PLACE DECIMALS ±0.01
 - THREE PLACE DECIMALS ±0.005
 - ANGLES ±1°
 - ALL DIA. CONCENTRIC WITHIN 0.005 T.I.R.
 2. FEATURES ON THE SAME CENTERLINE MUST BE ALIGNED WITHIN ±0.002
 3. REMOVE ALL BURRS

THIS DRAWING DESCRIBES A DESIGN CONSIDERED PROPRIETARY IN NATURE, DEVELOPED AND MANUFACTURED BY SWITCHCRAFT INC. AND IS RELEASED ON A CONFIDENTIAL BASIS FOR IDENTIFICATION PURPOSES ONLY.				
SIZE	WIDTH	MULT	LBS/M	TEMPER
FINISH		MATERIAL		
SPEC No.		SPEC No.		
FIRST USED ON		SCALE		
		3:1		
DATE DRAWN	BY	CHKD	APVD	
3-4-94	SG	2-6-95	2-6-95	
NAME		PART No.		
FEMALE CORD CONNECTOR		EN3C_F		
				REV
				G