

## 6A to 300A, 500VAC EMI Filters

### Features

- ◆ Lower cost (Than RTAN Series)
- ◆ DIN Rail Mount Option (Up 30A)
- ◆ Conforms to UL and EN Safety Agency Certifications



Specifications							
Model		RTEN-5006 RTEN-5006D	RTEN-5010 RTEN-5010D	RTEN-5020 RTEN-5020D	RTEN-5030 RTEN-5030D	RTEN-5040	
Rated Voltage (AC, DC)	V	500V Three phase					
Rated Current	A	6A	10A	20A	30A	40A	
DC Resistance (total)	mΩ	145	60	25	13	10	
Model		RTEN-5050	RTEN-5060	RTEN-5080	RTEN-5100	RTEN-5150	
Rated Voltage (AC, DC)	V	500V Three Phase					
Rated Current	A	50A	60A	80A	100A	150A	
DC Resistance (total)	mΩ	7	5	5	4	3	
Model		RTEN-5200	RTEN-5250	RTEN-5300			
Rated Voltage (AC, DC)	V	500V Three Phase					
Rated Current	A	200A	250A	300A			
DC Resistance (total)	mΩ	2	1.5	1			
Withstand Voltage	V	Terminals to Case: 2500VAC (1 Minute)					
Isolation Resistance	MΩ	100MΩ minimum (500VDC, 1 Minute)					
Leakage Current (max)	A	2.5mA at 250VAC 60Hz, 5mA at 500VAC 60Hz					
Operating Temperature	°C	-25 to +85°C (Derate above 50°C, see derating curve)					
Storage Temperature	°C	-25 to +85°C					
Safety Agency Certifications	-	UL1283 & EN60939					
Weight	g	360g to 9200g model dependant (See weights chart on website)					
Warranty	yr	1 Year					

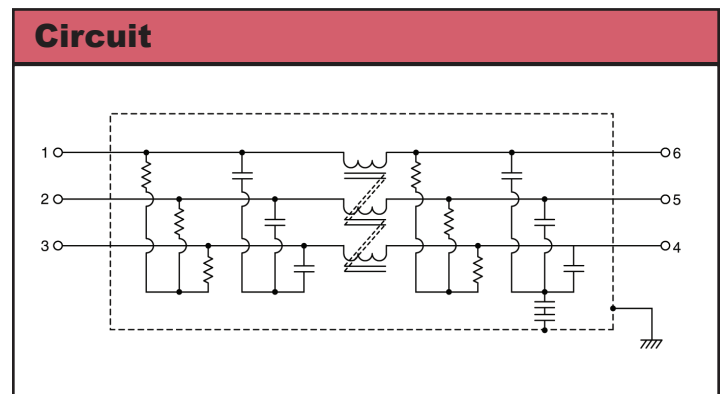
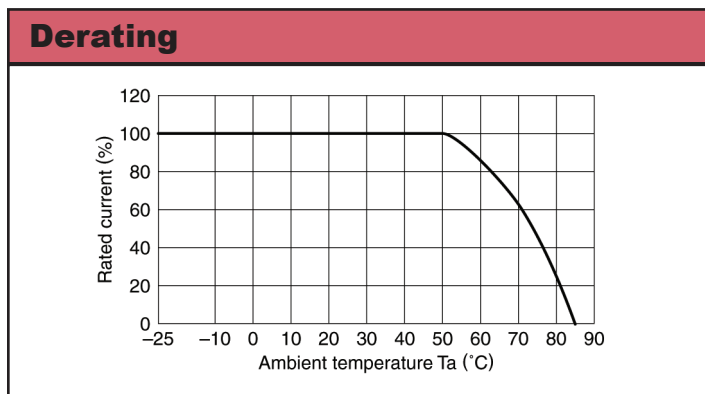

### Options

Chassis Mount	RTEN-5xxx
DIN Rail Mount (Models up to 30A)	RTEN-50xxD

## Outline Drawing

RTEN-5006/5010

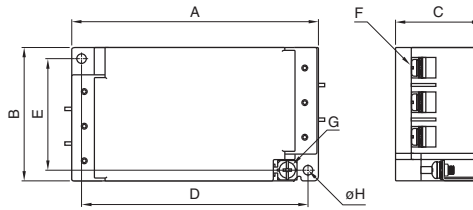

RTEN-5020/5030/5040/5050/5060

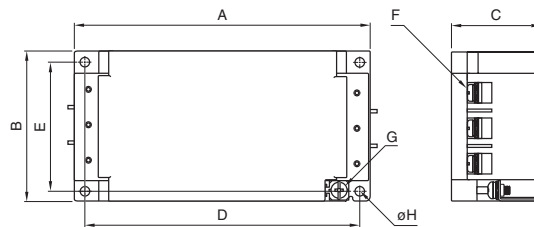

RTEN-5080/5100/5150/5200/5250/5300

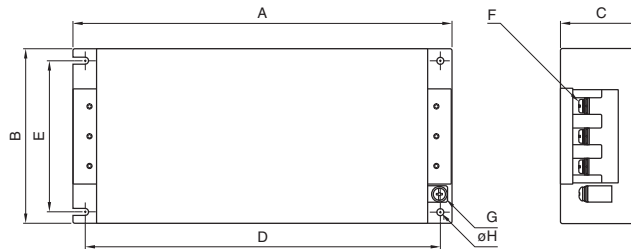

Dimensions in mm

Part No.	A	B	C	D	E	F	G	H	Recommended clamping torque
RTEN-5006	120	63	42	110	53	M4	M4	4.5	M4 1.27N m M5 2.5N m M6 4.8N m M8 7.64N m M10 11.8N m
RTEN-5010									
RTEN-5020	140	70	42	130	60	M4	M4		
RTEN-5030									
RTEN-5040									
RTEN-5050	170	90	54	160	80	M5	M4		
RTEN-5060									
RTEN-5080									
RTEN-5100	267	161	85	247	135	M8	M6	6.5	
RTEN-5150									
RTEN-5200	290	190	88	270	164	M8	M6	6.5	
RTEN-5250									
RTEN-5300									

For Additional Information, please visit  
[us.tdk-lambda.com/lp/products/r-series.htm](http://us.tdk-lambda.com/lp/products/r-series.htm)

