

## 3A to 60A, 250VAC EMI Filters

### Features

- ◆ High Voltage Pulse Attenuation
- ◆ Two Stage Filter for Better Performance
- ◆ DIN Rail Mount Option (Up 30A)
- ◆ Low Earth Leakage Current Option (Up to 30A)
- ◆ Conforms to UL, CSA and EN Safety Agency Certifications



Specifications						
Model		RSMN-2003 RSMN-2003D RSMN-2003L	RSMN-2006 RSMN-2006D RSMN-2006L	RSMN-2010 RSMN-2010D RSMN-2010L	RSMN-2016 RSMN-2016D RSMN-2016L	RSMN-2020 RSMN-2020D RSMN-2020L
Rated Voltage (AC, DC)	V	250V				
Rated Current	A	3A	6A	10A	16A	20A
Withstand Voltage	V	Terminals to Case: 2500VAC (1 Minute)				
Isolation Resistance	MΩ	100MΩ minimum (500VDC, 1 Minute)				
Leakage Current (max)	A	RSMN-20xx 1mA; RSMN20xxL 10uA (250VAC, 60Hz)				
DC Resistance (total)	mΩ	350	140	60	35	22
Model		RSMN-2030 RSMN-2030D RSMN-2030L	RSMN-2040	RSMN-2050	RSMN-2060	
Rated Voltage (AC, DC)	V	250V				
Rated Current	A	30A	40A	50A	60A	
Withstand Voltage	V	Terminals to Case: 2500VAC (1 Minute)				
Isolation Resistance	MΩ	100MΩ minimum (500VDC, 1 Minute)				
Leakage Current (max)	A	RSMN-20xx 1mA; RSMN20xxL 10uA (250VAC, 60Hz)				
DC Resistance (total)	mΩ	12	10	8	6	
Operating Temperature	°C	-25 to +85°C (Derate above 55°C, see derating curve)				
Storage Temperature	°C	-25 to +85°C				
Safety Agency Certifications	-	Up to 30A Models - UL1283, CSA C22.2 No.8, EN60939				
Weight	g	190g to 960g model dependant (See weights chart on website)				
Warranty	yr	1 Year				

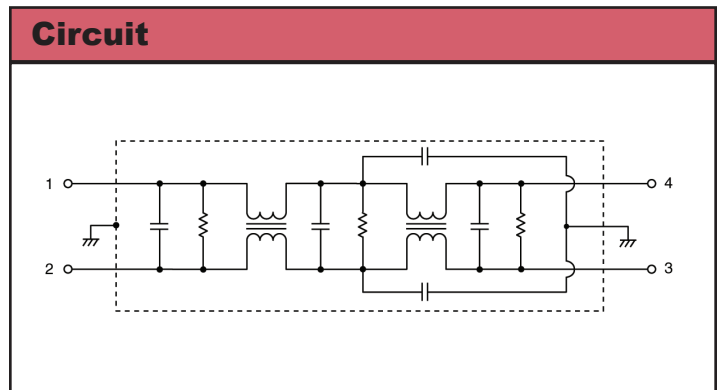
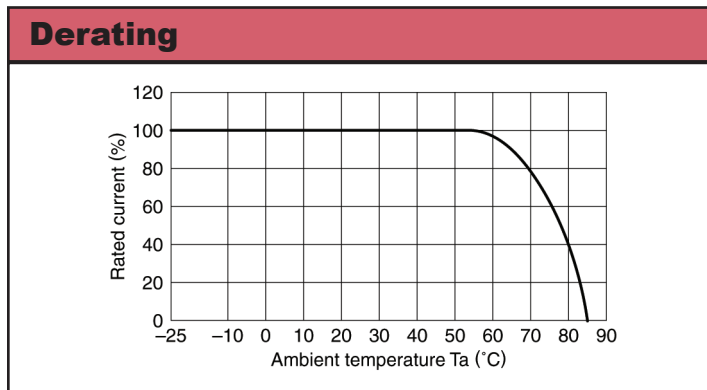

### Options

Chassis Mount & Standard Leakage Current	RSMN-20xx
DIN Rail Mount & Standard Leakage Current	RSMN-20xxD
Chassis Mount & Low Leakage Current	RSMN-20xxL

## Outline Drawing

RSMN-2003/2006/2010/2016/2020/2030

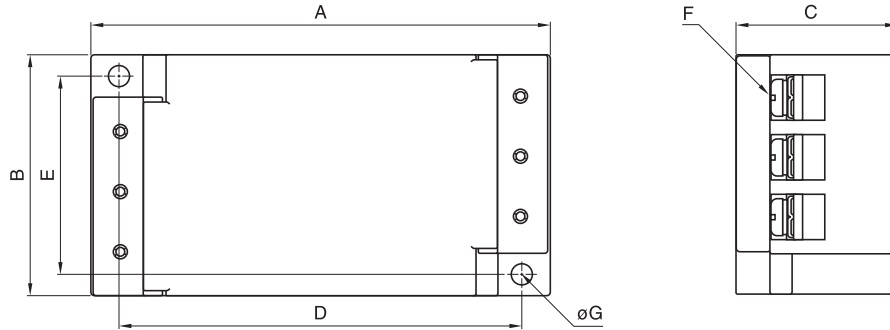

RSMN-2040/2050/2060

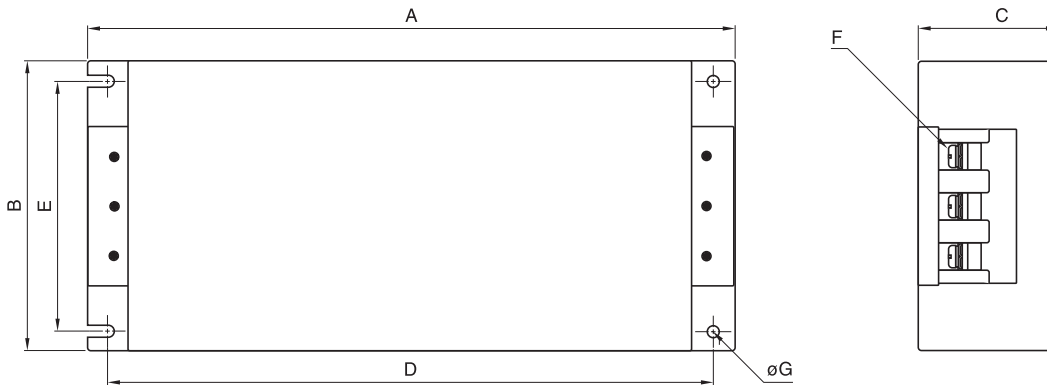

Dimensions in mm

Part No.	A	B	C	D	E	F	G	Recommended clamping torque
RSMN-2003	98	52	35	86	43	M4	4.5	1.27N m
RSMN-2006								
RSMN-2010								
RSMN-2016	127	52	35	115	43	M4	4.5	
RSMN-2020								
RSMN-2030								
RSMN-2040	272	100	60	254	82	M5	5.5	2.5N m
RSMN-2050								
RSMN-2060								

For Additional Information, please visit  
[us.tdk-lambda.com/lp/products/r-series.htm](http://us.tdk-lambda.com/lp/products/r-series.htm)

