



NTC Thermistors

SMD

NTCG series

| | |
|---------------|--------------------------|
| NTCG06 | 0603 [0201 inch]* |
| NTCG10 | 1005 [0402 inch] |
| NTCG16 | 1608 [0603 inch] |
| NTCG20 | 2012 [0805 inch] |

* Dimensions Code JIS[EIA]

REMINDERS FOR USING THESE PRODUCTS

Before using these products, be sure to request the delivery specifications.

SAFETY REMINDERS

Please pay sufficient attention to the warnings for safe designing when using these products.

REMINDERS

Please pay careful attention to the precautions and follow safe designing practices when using these products. Incorrect usage may lead to destroyed NTC thermistors and damages or malfunctions with the devices used.

- Please use them within the ranges of the ratings and performance provided in the Catalog and delivery specifications upon confirming the environments where they are to be used and installed.
- Do not use them outside the operating temperature range.
- Do not use them with the ratings or maximum permissible power levels exceeded.
- Do not quickly apply 5mW or more of load with the constant-voltage power supply in the NTC thermistor as this may lead to staying in thermal runaway mode or the red-shortening of chips.
- Please be cautious of the applied voltage in thermistors as instruments may malfunction with the lowering of resistance due to self heating.
- With instruments that consumers can touch the thermistors with their hands, please carefully warn them not to touch the thermistors.
- Store them in locations where the temperature is -10°C to $+40^{\circ}\text{C}$ and the relative humidity is 75% or below, avoid environments where there are sudden changes in temperatures, direct sunlight, corrosive gas, grit, or dust, and keep them packed in a manner where no loading stress is applied in order to avoid deterioration and damage. (Please use them within six months.)
- When sealing thermistors, please do so upon first considering the type, quantity, hardening conditions, and adhesiveness of the sealing material and confirming its reliability.
- Avoid powerful vibrations, impact (such as by dropping), pressure, etc. on thermistors that exceed the prescribed levels.
- Do not use them for long periods of time in environments with a relative humidity of over 85%. (This excludes cases where countermeasures have been taken.)
- Do not use them in the following environments. (This excludes cases where countermeasures have been taken.)
 - Environments with corrosive gas (Cl_2 , NH_3 , SO_x , NO_x , etc.)
 - Environments with highly conductive substances (electrolytes, water, saltwater, etc.)
 - Environments with acid, alkali, or organic solvents
 - Dusty areas
- Please observe the following precautions when attaching them to substrates as failure to do so may result in destruction or malfunction.
 - Do not let the substrates get warped or twisted at any time during the soldering.
 - The landing size must be even on both the left and right sides.
 - Do not use items that have been dropped or detached.
 - Do not allow the adherence of more solder than needed.
- Reflow mounting is recommended with NTC thermistors, and not flow (dip) mounting.
- Attaching or making corrections with a soldering iron is not recommended as it can lead to troubles such as significant distorting due to thermal shock or cracking. If a soldering iron must be used, it should be 30W or below with the temperature of the tip at 350°C or below, and at a maximum of 5 seconds of soldering time. Also, do not let the tip of the soldering iron come in direct contact with the chips.
- When attaching or making corrections with a soldering iron, the temperature of the tip of the soldering iron should be 350°C or below at a maximum of 5 seconds of soldering time. Do not let the tip of the soldering iron come in directly come in contact with the chips as doing so may lead to particularly large distortions due to thermal shock or cracking.
- Please use a substance such as resin that does not generate hydrogen (H_2) when forming insulation film over chips.
- Please contact our sales offices when considering the use of the products listed on this catalog for applications, whose performance and/or quality require a more stringent level of safety or reliability, or whose failure, malfunction or trouble could cause serious damage to society, person or property ('specific uses' such as automobiles, airplanes, medical instruments, nuclear devices, etc.) as well as when considering the use for applications that exceed the range and conditions of this catalog.

Please note that we are not responsible for any damages or losses incurred resulting from the use of these products that exceeds the range and conditions of this catalog or specific uses.

Please take appropriate measures such as acquiring protective circuits and devices that meet the uses, applications, and conditions of the instruments and keeping backup circuits.

NTC Thermistors

Product compatible with RoHS directive
Compatible with lead-free solders

SMD

Overview of the NTCG Series

CHARACTERISTICS OF NTC THERMISTORS (EXAMPLE)

NTC(Negative Temperature Coefficient) Thermistors are manufactured from sintered metal oxides. Each thermistor consists of a combination of two to four of the following materials: Manganese, Nickel, Cobalt and Copper. NTC thermistors are semiconductor resistors that exhibit decreasing resistance characteristics with increasing temperature. TDK thermistors have low thermal time constants which result in extremely high rates of resistance change to accurately track the temperature.

FEATURES

- Small sized 0603 type (L0.6× W0.3× T0.3mm) series are available.
- Lead (Pb) free product. By using lead-less terminal electrodes and electroplating (Ni-Sn), this product realized excellent solderability and soldering heat resistance, comparing with the conventional eutectic mixture solder and lead-free solder (Sn/Ag/Cu, etc.).
- Product series provides a wide range of resistances and B constants. Good stability of resistance value after soldering. The 0603, 1005, 1608 and 2012 size provide 4 different shapes with identical resistance-temperature characteristics. Attains less than low floating capacitance (using TCXO) in the high frequency region.

APPLICATION

- Temperature sensor
- Temperature compensation

TYPICAL USED SET AND TDK PRODUCT NAMES

| Used set | Applied circuit | Resistance (R25) | B constant (B25/85) | TDK recommended part number | |
|------------------------------|--|---|---------------------|-----------------------------|---------------|
| Mobile communication devices | TCXO(Temperature compensated crystal oscillator) | Low-temperature area compensated circuit | 30Ω to 100Ω | 3250K(2800K) | NTCG103EH400H |
| | | High-temperature area compensated circuit | 1.0kΩ to 3.0kΩ | 4100K to 4500K | NTCG104BH102H |
| | Power amplifier module | Power amplifier temperature compensated circuit | 30Ω to 10kΩ | 3250K to 4500K | NTCG104KH202J |
| | LCD | LCD temperature compensated circuit | 22kΩ to 1MΩ | 4550K to 4750K | NTCG104LH473J |
| | Temperature monitor | Various-circuit temperature compensated circuit | 10kΩ to 470kΩ | 4100K to 4750K | NTCG104BH103J |
| Battery pack | Battery temperature monitor and charging control circuit | 10kΩ to 100kΩ | 3435K to 4550K | NTCG103JF103F | |
| Computer devices | CPU | CPU temperature monitor | 10kΩ to 1MΩ | 3435K to 4550K | NTCG103JF103F |
| | LCD | LCD temperature compensated circuit | 22kΩ to 1MΩ | 4550K to 4750K | NTCG104LH473J |
| | HDD | Pickup temperature compensated circuit | 10kΩ to 100kΩ | 3435K to 4550K | NTCG103JF103F |
| | | | | | NTCG104EF104F |
| | ODD | CD or DVD write current compensated circuit | 10kΩ to 100kΩ | 3435K to 4550K | NTCG103JF103F |
| | Battery temperature monitor and charging control circuit | | | NTCG104EF104F | |
| DVC, DSC | Auto focus | Driving circuit temperature compensated circuit | 1.0kΩ to 15kΩ | 3435K to 4100K | NTCG104BH103J |
| | Iris stop | Hole element temperature compensated circuit | 10kΩ to 100kΩ | 3435K to 4550K | NTCG104LH473J |
| | Battery pack | Battery temperature monitor and charging control circuit | 10kΩ to 100kΩ | 3435K to 4550K | NTCG103JF103F |
| Car audio unit | Car CD or MD | Laser pickup temperature compensated circuit | 22kΩ to 150kΩ | 4550K | NTCG104LH473J |
| Optical transmission system | | Laser transmitter or receiver temperature compensated circuit | 1.0kΩ to 150kΩ | 4100K to 4550K | NTCG104LH154J |
| Printer | | Ink viscosity controller | 10kΩ to 47kΩ | 3435K to 4550K | NTCG104LH473H |

○ RoHS Directive Compliant Product: See the following for more details related to RoHS Directive compliant products. <http://product.tdk.com/en/environment/rohs/>

 Please be sure to request delivery specifications that provide further details on the features and specifications of the products for proper and safe use. Please note that the contents may change without any prior notice due to reasons such as upgrading.

Overview of the NTCG Series

CIRCUIT EXAMPLES

1. CELLULAR PHONE, TABLET TERMINAL

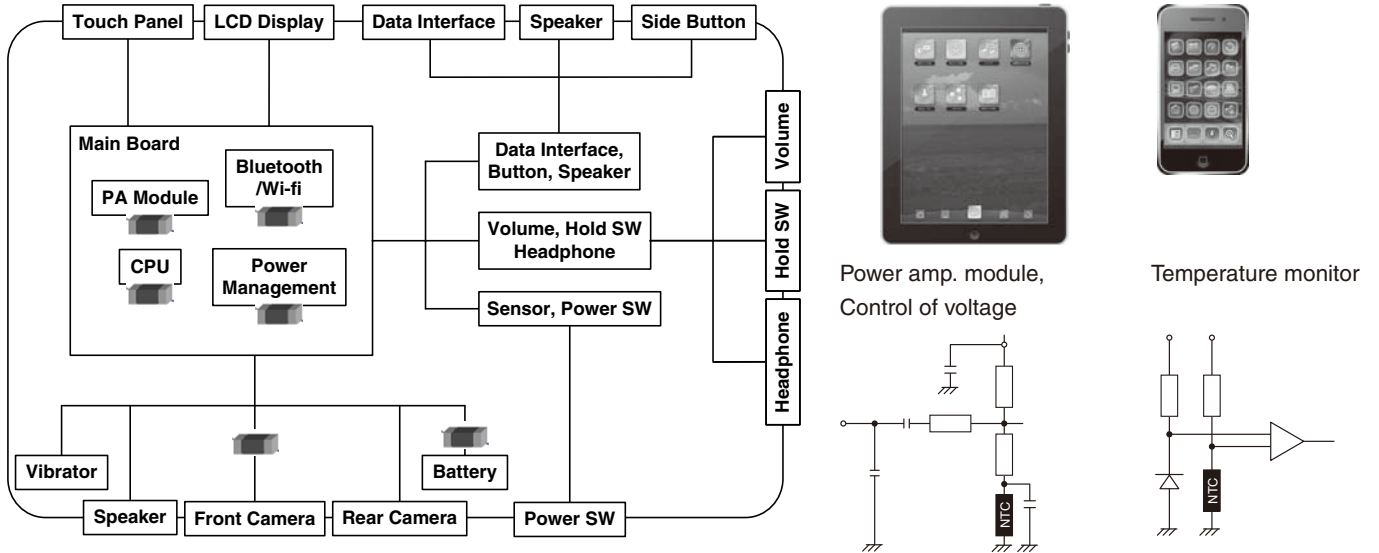

2. HARD DISK DRIVE

Chip NTC thermistor

NTCG06, NTCG10 types

Resistance tolerance: ± 1 to $\pm 5\%$ /B constant tolerance: ± 1 to $\pm 3\%$

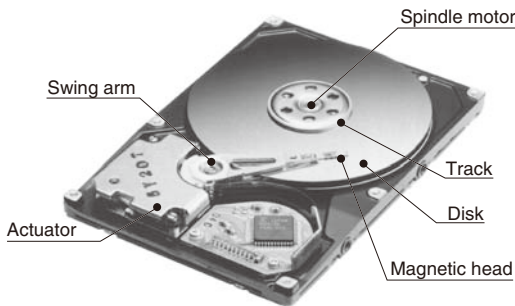

TEMPERATURE SENSOR IC

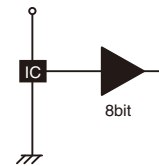

NTC THERMISTOR

(Cost: about 50% down)

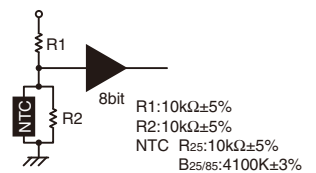

Voltage vs. temperature characteristics

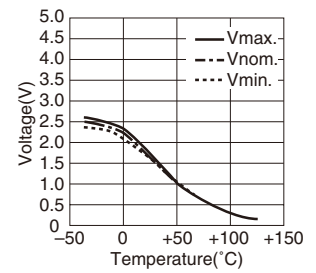
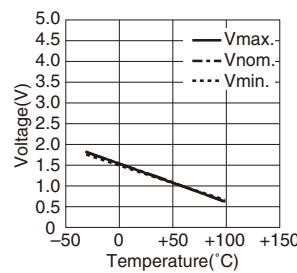

3. BATTERY PACK

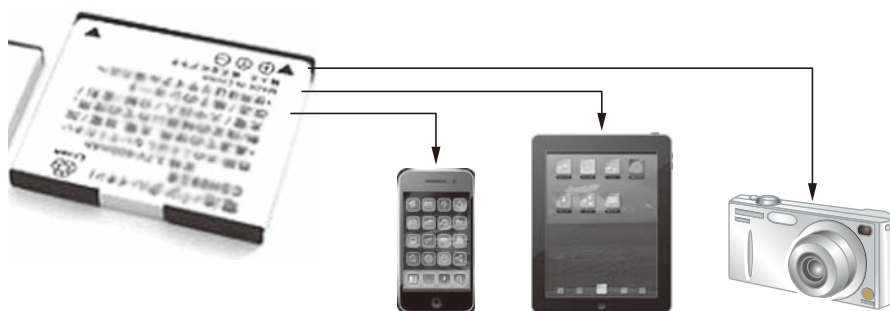

Control circuit for quick charge battery

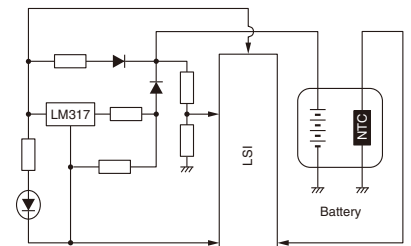

Please be sure to request delivery specifications that provide further details on the features and specifications of the products for proper and safe use. Please note that the contents may change without any prior notice due to reasons such as upgrading.

Overview of the NTCG Series

RESISTANCE VALUE RANGE

| Resistance Type | 10Ω | 100Ω | 1kΩ | 10kΩ | 100kΩ | 1MΩ |
|-----------------|-----|------|-----|------|-------|-------|
| NTCG06 | 30Ω | | | | | 1MΩ |
| NTCG10 | 30Ω | | | | | 1MΩ |
| NTCG16 | 30Ω | | | | | 1MΩ |
| NTCG20 | | 470Ω | | | | 150kΩ |

LIST OF SERIES BY TYPE

| Type | B constant(K) | Nominal resistance(Ω) [at 25°C] | | | | | |
|----------------------------|---------------|---------------------------------|-------|-------|------------------------|-------|-------|
| | | 10Ω | 100Ω | 1kΩ | 10kΩ | 100kΩ | 1MΩ |
| NTCG06 NTCG10 NTCG16 | 2800K | | | 100Ω | | | |
| | 3250K | 30Ω | | 150Ω | | | |
| | 3435K | | | | 10kΩ | | |
| | 3650K | | 220Ω | 680Ω | | | |
| | 4100K | | | 1.0kΩ | 3.0kΩ | | |
| | 4100K | | | | 3.3kΩ | 15kΩ | |
| | 4550K | | | | (0603 type: 33kΩ min.) | 22kΩ | 150kΩ |
| | 4750K | | | | | 220kΩ | 1MΩ |
| 4500K | | | 2.0kΩ | 3.0kΩ | | | |
| NTCG20 | 3250K | | 470Ω | 680Ω | | | |
| | 3100K | | | 1.0kΩ | 1.5kΩ | | |
| | 3300K | | | 2.2kΩ | 3.3kΩ | | |
| | 3450K | | | 4.7kΩ | 6.8kΩ | | |
| | 3650K | | | | 10kΩ | 15kΩ | |
| | 3850K | | | | | 22kΩ | 33kΩ |
| | 4000K | | | | | 47kΩ | 68kΩ |
| | 4150K | | | | | 100kΩ | 150kΩ |

* B constant is calculated from the resistance at 25°C and 85°C

The B constant indicates the magnitude of a change in a zero-load resistance value to a temperature, and is obtained based on arbitrary two temperatures in resistance-to-temperature characteristics.

B constant calculation formula

$$B = \frac{\ln R_1 - \ln R_2}{(1/T_1) - (1/T_2)}$$

B: B Constant (K)

T1: Arbitrary temperature (K)

T2: Arbitrary temperature different from T1 (K)

R1: Zero-load resistance value at temperature T1(Ω)

R2: Zero-load resistance value at temperature T2(Ω)

Each temperature is measured in absolute temperature. 0°C=273.15K

Overview of the NTCG Series

PART NUMBER CONSTRUCTION

| NTC | G | ○○ | 3E | H | 101 | □ | T | □ | | | | | | | |
|----------------|---|----------------------------|------|-------------|--------------|--------------------------|----|------------------------|--------------|------------------------------------|----|-----------------|--------|--|---|
| Series name | Structural classification | Shapes and dimensions code | | B constant* | | B constant tolerance (%) | | Nominal resistance (Ω) | | Nominal resistance tolerance** (%) | | Packaging style | | TDK internal code: Taping specifications | |
| NTC thermistor | G Multilayer internal electroded chip type NTC thermistor (Pb free type) | 06 | 0603 | 3E | 3201 to 3250 | F | ±1 | 300 | 30 | F | ±1 | T | Taping | 1 | Standard |
| | | 10 | 1005 | 3N | 3601 to 3650 | H | ±3 | 101 | 100 | G | ±2 | B | Bulk | B | NTCG06 type standard |
| | | 16 | 1608 | 4L | 4501 to 4550 | | | 102 | 1000 (1kΩ) | H | ±3 | | | DS | Automotive (High reliability) |
| | | 20 | 2012 | 4Q | 4701 to 4750 | | | 103 | 10000 (10kΩ) | J | ±5 | | | 1S | 150°C correspondence (High reliability) |

* The size of the B constant is indicated with a combination of one numeric character and one alphabetic character. Refer to the below for values representing numeric characters and alphabetic characters.

** Resistance tolerance H(±3%) products: NTCG20 type is excluded. For more details, please contact us separately.

| Numeric characters (Represent the thousands place of the B constant) | | Alphabetic characters (Represent the ones, tens, and hundreds places of the B constant) | | | | |
|---|------|--|------------|--|---|------------|
| 2 | 2000 | A | 0 to 50 | | K | 451 to 500 |
| 3 | 3000 | B | 51 to 100 | | L | 501 to 550 |
| 4 | 4000 | C | 101 to 150 | | N | 601 to 650 |
| | | E | 201 to 250 | | Q | 701 to 750 |
| | | F | 251 to 300 | | S | 801 to 850 |
| | | J | 401 to 450 | | | |

OPERATING TEMPERATURE RANGE, PACKAGE QUANTITY, PRODUCT WEIGHT

| Type* | Temperature range | | Package quantity | Individual weight |
|--------|-------------------------|------------------------|------------------|-------------------|
| | Operating temperature** | Storage temperature*** | | |
| | (°C) | (°C) | (pieces/reel) | (mg) |
| NTCG06 | -40 to +125 | -40 to +125 | 15000 | 0.3 |
| NTCG10 | Standard | -40 to +125 | 10000 | 2.5 |
| | High reliability | -40 to +150 | | |
| NTCG16 | Standard | -40 to +125 | 4000 | 5.0 |
| | High reliability | -40 to +150 | | |
| NTCG20 | -40 to +125 | -40 to +125 | 2000 | 7.2 |

* Concerning the "Standard" and "High reliability" of NTCG10 and NTCG16 types, please refer to Taping specifications in PART NUMBER CONSTRUCTION.

** Operating temperature range includes self-temperature rise.

*** The Storage temperature range is for after the circuit board is mounted.

Overview of the NTCG Series

RECOMMENDED REFLOW PROFILE

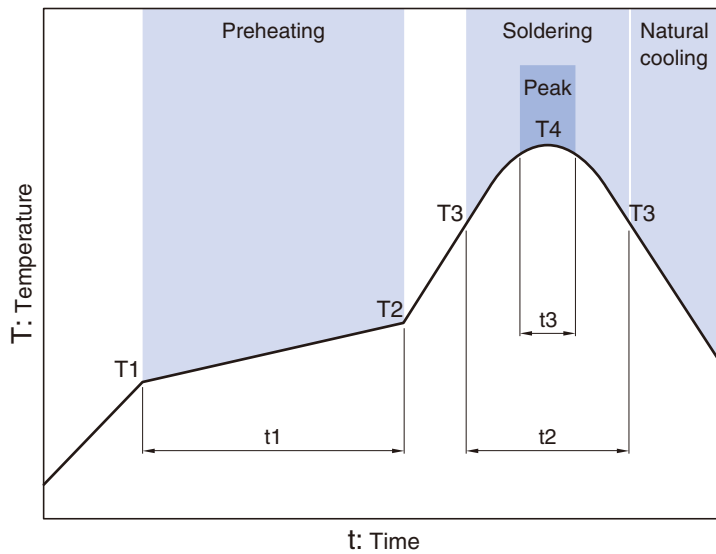

| Preheating | | | Soldering | | Peak | |
|------------|-------|------------|-----------|------|--------------|----------|
| Temp. | | Time | Temp. | Time | Temp. | Time |
| T1 | T2 | t1 | T3 | t2 | T4 | t3 |
| 150°C | 180°C | 60 to 120s | 220°C | 60s | 250 to 260°C | 10s max. |

NTCG series

NTCG06 Type



SHAPE & DIMENSIONS

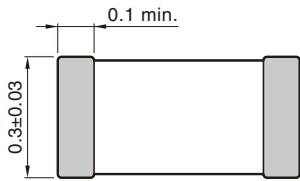
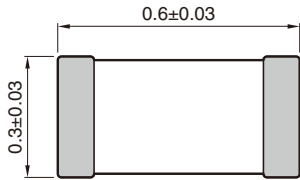

Electrode material
Internal: Pd
External: Ag/Ni/Sn
Dimensions in mm

STRUCTURAL DIAGRAM

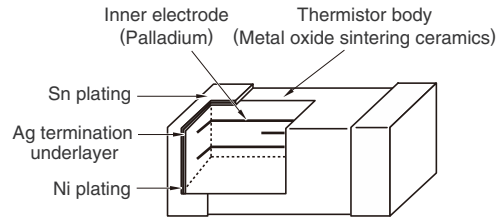

RECOMMENDED LAND PATTERN

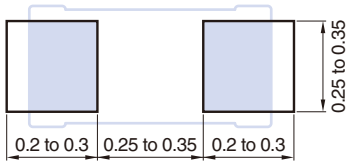

⚠ Please be sure to request delivery specifications that provide further details on the features and specifications of the products for proper and safe use. Please note that the contents may change without any prior notice due to reasons such as upgrading.

NTCG series NTCG06 Type

ELECTRICAL CHARACTERISTICS

CHARACTERISTICS SPECIFICATION TABLE

| Resistance-temperature group | Part No.* | Nominal resistance value [25°C] | B constant | |
|------------------------------|---------------|------------------------------------|------------|-----------|
| | | | [25/85°C] | [25/50°C] |
| A | NTCG063EH300□ | 30Ω | 3250K±3% | (3244K) |
| | NTCG063EH400□ | 40Ω | 3250K±3% | (3244K) |
| B | NTCG062QH101□ | 100Ω | 2800K±3% | (2794K) |
| D | NTCG064KH202□ | 2.0kΩ | 4500K±3% | (4498K) |
| | NTCG064KH302□ | 3.0kΩ | 4500K±3% | (4498K) |
| E | NTCG064BH103□ | 10kΩ | 4100K±3% | (4067K) |
| H | NTCG063JH103□ | 10kΩ | 3435K±3% | (3380K) |

* The "□" of the Part Number contains the nominal resistance tolerance, H (±3%) or J (±5%). However, in case the nominal resistance value is 30Ω or less, only J can be contained.

RESISTANCE vs. TEMPERATURE CHARACTERISTICS TABLE (CONVERSION TABLE)

| Temp.(°C) | Resistance-temperature group | | | | | | | | | |
|-----------|------------------------------|---------|--------|---------|---------|---------|-----------------------|---------|--------|--------------------------------------|
| | A | | B | | D | | E | | H | |
| | RT/R25 | B(25/T) | RT/R25 | B(25/T) | RT/R25 | B(25/T) | RT/R25 | B(25/T) | RT/R25 | B(25/T) |
| -40 | 19.59 | 3182 | 12.65 | 2714 | 58.88 | 4358 | 38.44 | 3903 | 18.850 | 3140 |
| -35 | 14.79 | 3188 | 9.960 | 2720 | 40.29 | 4374 | 27.34 | 3915 | 14.429 | 3159 |
| -30 | 11.28 | 3193 | 7.912 | 2726 | 27.92 | 4389 | 19.68 | 3928 | 11.133 | 3176 |
| -25 | 8.685 | 3199 | 6.337 | 2732 | 19.59 | 4402 | 14.33 | 3939 | 8.656 | 3194 |
| -20 | 6.753 | 3204 | 5.116 | 2738 | 13.90 | 4415 | 10.54 | 3951 | 6.779 | 3210 |
| -15 | 5.298 | 3208 | 4.161 | 2743 | 9.976 | 4426 | 7.837 | 3962 | 5.346 | 3226 |
| -10 | 4.192 | 3213 | 3.408 | 2749 | 7.236 | 4436 | 5.883 | 3972 | 4.245 | 3241 |
| -5 | 3.343 | 3217 | 2.810 | 2754 | 5.303 | 4446 | 4.456 | 3982 | 3.393 | 3256 |
| 0 | 2.687 | 3220 | 2.332 | 2759 | 3.925 | 4454 | 3.406 | 3992 | 2.728 | 3270 |
| 5 | 2.176 | 3224 | 1.947 | 2763 | 2.933 | 4462 | 2.625 | 4001 | 2.207 | 3283 |
| 10 | 1.774 | 3227 | 1.635 | 2768 | 2.212 | 4469 | 2.039 | 4010 | 1.796 | 3296 |
| 15 | 1.456 | 3230 | 1.381 | 2772 | 1.683 | 4475 | 1.596 | 4018 | 1.470 | 3308 |
| 20 | 1.203 | 3233 | 1.172 | 2776 | 1.292 | 4480 | 1.259 | 4026 | 1.209 | 3320 |
| 25 | 1.000 ^{*1} | 3235 | 1.000 | 2780 | 1.000 | 4485 | 1.000 ^{*2} | 4034 | 1.000 | 3332 |
| 30 | 0.8360 | 3237 | 0.857 | 2783 | 0.7801 | 4488 | 0.7997 | 4041 | 0.831 | 3343 |
| 35 | 0.7029 | 3239 | 0.738 | 2786 | 0.6133 | 4492 | 0.6437 | 4048 | 0.694 | 3353 |
| 40 | 0.5941 | 3241 | 0.639 | 2789 | 0.4857 | 4494 | 0.5213 | 4055 | 0.583 | 3363 |
| 45 | 0.5047 | 3243 | 0.555 | 2792 | 0.3875 | 4497 | 0.4248 | 4061 | 0.491 | 3373 |
| 50 | 0.4309 | 3244 | 0.484 | 2794 | 0.3112 | 4498 | 0.3481 | 4067 | 0.416 | 3382 ^{*3} (3346 to 3414) |
| 55 | 0.3697 | 3246 | 0.424 | 2796 | 0.2516 | 4500 | 0.2869 | 4072 | 0.354 | 3390 |
| 60 | 0.3185 | 3247 | 0.373 | 2797 | 0.2048 | 4501 | 0.2377 | 4078 | 0.302 | 3399 |
| 65 | 0.2757 | 3248 | 0.329 | 2799 | 0.1677 | 4501 | 0.1979 | 4083 | 0.259 | 3407 |
| 70 | 0.2396 | 3248 | 0.292 | 2799 | 0.1381 | 4501 | 0.1657 | 4087 | 0.223 | 3414 |
| 75 | 0.2091 | 3249 | 0.260 | 2800 | 0.11439 | 4501 | 0.1393 | 4092 | 0.192 | 3422 |
| 80 | 0.1832 | 3250 | 0.232 | 2800 | 0.09528 | 4501 | 0.1177 | 4096 | 0.167 | 3428 |
| 85 | 0.1610 ^{*1} | 3250 | 0.207 | 2800 | 0.07978 | 4500 | 0.09989 ^{*2} | 4100 | 0.145 | 3435 |
| 90 | 0.1421 | 3250 | 0.186 | 2799 | 0.06714 | 4499 | 0.08513 | 4104 | 0.127 | 3441 |
| 95 | 0.1258 | 3251 | 0.168 | 2798 | 0.05679 | 4498 | 0.07286 | 4107 | 0.111 | 3447 |
| 100 | 0.1118 | 3251 | 0.152 | 2797 | 0.04826 | 4497 | 0.06260 | 4110 | 0.0975 | 3453 |
| 105 | 0.09960 | 3251 | 0.138 | 2795 | 0.04119 | 4495 | 0.05400 | 4114 | 0.0860 | 3458 |
| 110 | 0.08903 | 3251 | 0.125 | 2793 | 0.03532 | 4493 | 0.04675 | 4116 | 0.0760 | 3463 |
| 115 | 0.07981 | 3251 | 0.114 | 2790 | 0.03041 | 4491 | 0.04063 | 4119 | 0.0674 | 3468 |
| 120 | 0.07175 | 3251 | 0.104 | 2787 | 0.02629 | 4489 | 0.03543 | 4122 | 0.0599 | 3473 |
| 125 | 0.06468 | 3251 | 0.096 | 2783 | 0.02282 | 4487 | 0.03099 | 4124 | 0.0534 | 3478 |

Examples

$$^*1 R_{25} = R_{25}/R_{25}(1.000) \times 30 = 30\Omega$$

$$^*2 R_{25} = R_{25}/R_{25}(1.000) \times 10 = 10k\Omega$$

$$^*3 B_{25/50} = 3380 \pm 1\%$$

$$R_{85} = R_{85}/R_{25}(0.1610) \times R_{25}(30\Omega) = 4.83\Omega$$

$$R_{85} = R_{85}/R_{25}(0.09989) \times R_{25}(10k\Omega) = 0.999k\Omega$$

 Please be sure to request delivery specifications that provide further details on the features and specifications of the products for proper and safe use. Please note that the contents may change without any prior notice due to reasons such as upgrading.

NTCG series **NTCG06 Type** (Narrow tolerance type products)

ELECTRICAL CHARACTERISTICS

CHARACTERISTICS SPECIFICATION TABLE

| Resistance-temperature group | Part No.* | Nominal resistance value [25°C] | B constant | |
|------------------------------|---------------|------------------------------------|------------|-----------|
| | | | [25/85°C] | [25/50°C] |
| H | NTCG063JF103□ | 10kΩ±□% | 3435K±1% | (3380K) |
| | NTCG064EF104□ | 100kΩ±□% | (4308K) | 4250K±1% |

* The products support narrow tolerance. The " □ " of the Part Number contains the nominal resistance tolerance, F (±1%), G (±2%), or H (±3%).

RESISTANCE vs. TEMPERATURE CHARACTERISTICS TABLE (CONVERSION TABLE)

| Temp.(°C) | Resistance-temperature group | | | | | |
|-----------|------------------------------|--------------------------------------|--------|--------------------------------------|--------|---------|
| | H | | J | | K | |
| | RT/R25 | B(25/T) | RT/R25 | B(25/T) | RT/R25 | B(25/T) |
| -40 | 18.850 | 3140 | 35.340 | 3813 | 42.510 | 4010 |
| -35 | 14.429 | 3159 | 25.280 | 3822 | 30.049 | 4027 |
| -30 | 11.133 | 3176 | 18.330 | 3834 | 21.489 | 4043 |
| -25 | 8.656 | 3194 | 13.470 | 3848 | 15.538 | 4059 |
| -20 | 6.779 | 3210 | 10.010 | 3864 | 11.353 | 4075 |
| -15 | 5.346 | 3226 | 7.520 | 3882 | 8.378 | 4090 |
| -10 | 4.245 | 3241 | 5.697 | 3900 | 6.241 | 4105 |
| -5 | 3.393 | 3256 | 4.352 | 3919 | 4.691 | 4119 |
| 0 | 2.728 | 3270 | 3.349 | 3937 | 3.556 | 4133 |
| 5 | 2.207 | 3283 | 2.596 | 3956 | 2.718 | 4147 |
| 10 | 1.796 | 3296 | 2.026 | 3974 | 2.094 | 4160 |
| 15 | 1.470 | 3308 | 1.591 | 3989 | 1.625 | 4172 |
| 20 | 1.209 | 3320 | 1.258 | 4012 | 1.270 | 4185 |
| 25 | 1.000 | 3332 | 1.000 | 4024 | 1.000 | 4196 |
| 30 | 0.831 | 3343 | 0.800 | 4036 | 0.792 | 4208 |
| 35 | 0.694 | 3353 | 0.644 | 4049 | 0.632 | 4219 |
| 40 | 0.583 | 3363 | 0.521 | 4062 | 0.507 | 4230 |
| 45 | 0.491 | 3373 | 0.424 | 4074 | 0.409 | 4240 |
| 50 | 0.416 | 3382* ¹ (3346 to 3414) | 0.347 | 4085* ² (3928 to 4171) | 0.332 | 4250 |
| 55 | 0.354 | 3390 | 0.285 | 4096 | 0.271 | 4259 |
| 60 | 0.302 | 3399 | 0.235 | 4106 | 0.222 | 4269 |
| 65 | 0.259 | 3407 | 0.195 | 4115 | 0.183 | 4277 |
| 70 | 0.223 | 3414 | 0.163 | 4126 | 0.152 | 4286 |
| 75 | 0.192 | 3422 | 0.137 | 4134 | 0.126 | 4293 |
| 80 | 0.167 | 3428 | 0.115 | 4142 | 0.106 | 4301 |
| 85 | 0.145 | 3435 | 0.0971 | 4150 | 0.0889 | 4308 |
| 90 | 0.127 | 3441 | 0.0824 | 4158 | 0.0750 | 4315 |
| 95 | 0.111 | 3447 | 0.0702 | 4165 | 0.0636 | 4321 |
| 100 | 0.0975 | 3453 | 0.0601 | 4172 | 0.0541 | 4327 |
| 105 | 0.0860 | 3458 | 0.0515 | 4179 | 0.0462 | 4332 |
| 110 | 0.0760 | 3463 | 0.0444 | 4186 | 0.0397 | 4338 |
| 115 | 0.0674 | 3468 | 0.0384 | 4193 | 0.0342 | 4342 |
| 120 | 0.0599 | 3473 | 0.0333 | 4199 | 0.0295 | 4347 |
| 125 | 0.0534 | 3478 | 0.0289 | 4206 | 0.0256 | 4351 |

*1 B25/50: 3380±1%

*2 B25/50: 4050±3%

NTCG series **NTCG06 Type**

CHARACTERISTICS OF NTC THERMISTORS (EXAMPLE)

Y-axis: Linear

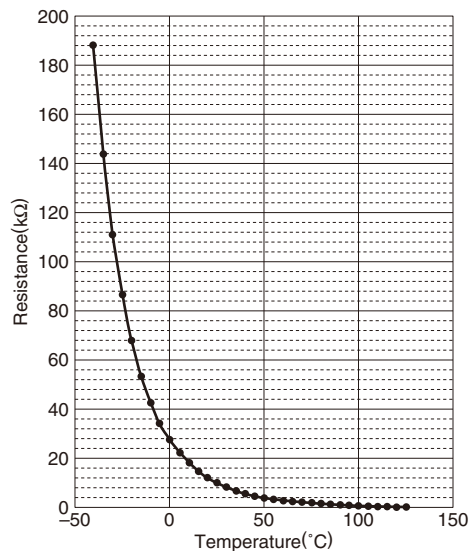

Y-axis: Log.

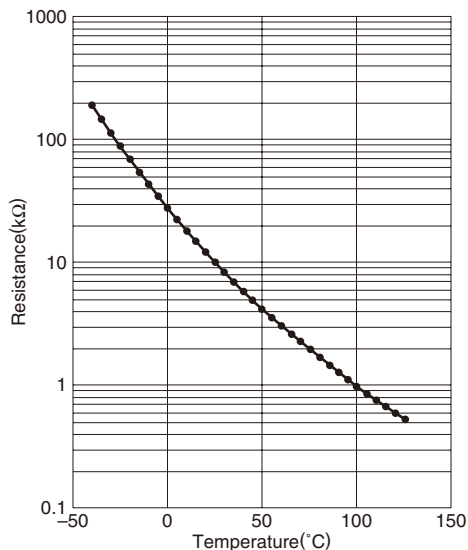

Please be sure to request delivery specifications that provide further details on the features and specifications of the products for proper and safe use. Please note that the contents may change without any prior notice due to reasons such as upgrading.

NTCG series

NTCG10 Type



SHAPE & DIMENSIONS

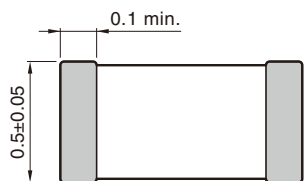
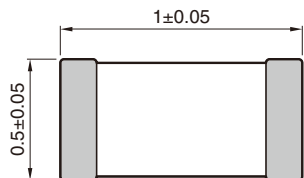

Electrode material
Internal: Pd
External: Ag/Ni/Sn

Dimensions in mm

STRUCTURAL DIAGRAM

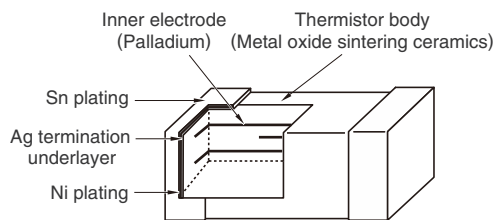

RECOMMENDED LAND PATTERN

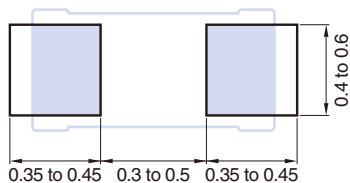

Please be sure to request delivery specifications that provide further details on the features and specifications of the products for proper and safe use. Please note that the contents may change without any prior notice due to reasons such as upgrading.

NTCG series **NTCG10 Type**

■ ELECTRICAL CHARACTERISTICS

□ CHARACTERISTICS SPECIFICATION TABLE

| Resistance-temperature group | Part No.* | Nominal resistance value [25°C] | B constant | |
|------------------------------|---------------|------------------------------------|------------|-----------|
| | | | [25/85°C] | [25/50°C] |
| A | NTCG103EH300□ | 30Ω | 3250K±3% | (3244K) |
| | NTCG103EH400□ | 40Ω | 3250K±3% | (3244K) |
| | NTCG103EH101□ | 100Ω | 3250K±3% | (3244K) |
| C | NTCG104BH102□ | 1.0kΩ | 4100K±3% | (4096K) |
| | NTCG104BH152□ | 1.5kΩ | 4100K±3% | (4096K) |
| | NTCG104BH222□ | 2.2kΩ | 4100K±3% | (4096K) |
| E | NTCG104BH472□ | 4.7kΩ | 4100K±3% | (4067K) |
| | NTCG104BH682□ | 6.8kΩ | 4100K±3% | (4067K) |
| | NTCG104BH103□ | 10kΩ | 4100K±3% | (4067K) |
| F | NTCG104LH223□ | 22kΩ | 4550K±3% | (4485K) |
| | NTCG104LH333□ | 33kΩ | 4550K±3% | (4485K) |
| | NTCG104LH473□ | 47kΩ | 4550K±3% | (4485K) |
| | NTCG104LH683□ | 68kΩ | 4550K±3% | (4485K) |
| | NTCG104LH104□ | 100kΩ | 4550K±3% | (4485K) |
| G | NTCG104LH154□ | 150kΩ | 4550K±3% | (4485K) |
| | NTCG104QH224□ | 220kΩ | 4750K±3% | (4661K) |
| | NTCG104QH334□ | 330kΩ | 4750K±3% | (4661K) |
| | NTCG104QH474□ | 470kΩ | 4750K±3% | (4661K) |
| H | NTCG104QH105□ | 1.0MΩ | 4750K±3% | (4661K) |
| | NTCG103JH103□ | 10kΩ | 3435K±3% | (3380K) |
| J | NTCG104BF473□ | 47kΩ | (4150K) | 4085K±1% |
| | NTCG104BF683□ | 68kΩ | (4150K) | 4085K±1% |
| K | NTCG104EH104□ | 100kΩ | (4308K) | 4250K±3% |
| U | NTCG103UH103J | 10kΩ | 3950K±3% | (3900K) |

* The "□" of the Part Number contains the nominal resistance tolerance, H (±3%) or J (±5%). However, in case the nominal resistance value is 30Ω or less, only J can be contained.

NTCG series **NTCG10 Type**

■ ELECTRICAL CHARACTERISTICS

□ RESISTANCE vs. TEMPERATURE CHARACTERISTICS TABLE (CONVERSION TABLE)

| Temp.(°C) | Resistance-temperature group | | | | | | | |
|-----------|------------------------------|---------|---------|---------|-----------------------|---------|---------|---------|
| | A | | C | | E | | F | |
| | RT/R25 | B(25/T) | RT/R25 | B(25/T) | RT/R25 | B(25/T) | RT/R25 | B(25/T) |
| -40 | 19.59 | 3182 | 41.78 | 3991 | 38.44 | 3903 | 50.89 | 4203 |
| -35 | 14.79 | 3188 | 29.45 | 4003 | 27.34 | 3915 | 35.49 | 4224 |
| -30 | 11.28 | 3193 | 21.01 | 4014 | 19.68 | 3928 | 25.03 | 4245 |
| -25 | 8.685 | 3199 | 15.17 | 4024 | 14.33 | 3939 | 17.85 | 4264 |
| -20 | 6.753 | 3204 | 11.07 | 4033 | 10.54 | 3951 | 12.86 | 4284 |
| -15 | 5.298 | 3208 | 8.168 | 4041 | 7.837 | 3962 | 9.353 | 4302 |
| -10 | 4.192 | 3213 | 6.087 | 4049 | 5.883 | 3972 | 6.869 | 4320 |
| -5 | 3.343 | 3217 | 4.581 | 4056 | 4.456 | 3982 | 5.090 | 4337 |
| 0 | 2.687 | 3220 | 3.480 | 4062 | 3.406 | 3992 | 3.805 | 4353 |
| 5 | 2.176 | 3224 | 2.667 | 4068 | 2.625 | 4001 | 2.868 | 4369 |
| 10 | 1.774 | 3227 | 2.062 | 4073 | 2.039 | 4010 | 2.179 | 4384 |
| 15 | 1.456 | 3230 | 1.607 | 4077 | 1.596 | 4018 | 1.669 | 4399 |
| 20 | 1.203 | 3233 | 1.263 | 4081 | 1.259 | 4026 | 1.287 | 4412 |
| 25 | 1.000* ¹ | 3235 | 1.000 | 4084 | 1.000* ² | 4034 | 1.000 | 4426 |
| 30 | 0.8360 | 3237 | 0.7976 | 4088 | 0.7997 | 4041 | 0.7823 | 4439 |
| 35 | 0.7029 | 3239 | 0.6407 | 4090 | 0.6437 | 4048 | 0.6160 | 4451 |
| 40 | 0.5941 | 3241 | 0.5182 | 4092 | 0.5213 | 4055 | 0.4882 | 4463 |
| 45 | 0.5047 | 3243 | 0.4218 | 4094 | 0.4248 | 4061 | 0.3893 | 4474 |
| 50 | 0.4309 | 3244 | 0.3455 | 4096 | 0.3481 | 4067 | 0.3123 | 4485 |
| 55 | 0.3697 | 3246 | 0.2847 | 4097 | 0.2869 | 4072 | 0.2520 | 4496 |
| 60 | 0.3185 | 3247 | 0.2360 | 4098 | 0.2377 | 4078 | 0.2044 | 4506 |
| 65 | 0.2757 | 3248 | 0.1967 | 4099 | 0.1979 | 4083 | 0.1667 | 4515 |
| 70 | 0.2396 | 3248 | 0.1648 | 4099 | 0.1657 | 4087 | 0.1367 | 4524 |
| 75 | 0.2091 | 3249 | 0.1388 | 4100 | 0.1393 | 4092 | 0.1126 | 4533 |
| 80 | 0.1832 | 3250 | 0.1175 | 4100 | 0.1177 | 4096 | 0.09325 | 4542 |
| 85 | 0.1610* ¹ | 3250 | 0.0999 | 4100 | 0.09989* ² | 4100 | 0.07757 | 4550 |
| 90 | 0.1421 | 3250 | 0.0853 | 4100 | 0.08513 | 4104 | 0.06482 | 4558 |
| 95 | 0.1258 | 3251 | 0.0732 | 4100 | 0.07286 | 4107 | 0.05440 | 4565 |
| 100 | 0.1118 | 3251 | 0.0630 | 4100 | 0.06260 | 4110 | 0.04584 | 4573 |
| 105 | 0.09960 | 3251 | 0.05451 | 4100 | 0.05400 | 4114 | 0.03879 | 4580 |
| 110 | 0.08903 | 3251 | 0.04731 | 4100 | 0.04675 | 4116 | 0.03295 | 4586 |
| 115 | 0.07981 | 3251 | 0.04121 | 4101 | 0.04063 | 4119 | 0.02810 | 4593 |
| 120 | 0.07175 | 3251 | 0.03602 | 4101 | 0.03543 | 4122 | 0.02405 | 4599 |
| 125 | 0.06468 | 3251 | 0.03159 | 4101 | 0.03099 | 4124 | 0.02066 | 4606 |

Examples

$$*1 R25=R25/R25(1.000)\times 30=30\Omega$$

$$R85=R85/R25(0.1610)\times R25(30\Omega)=4.83\Omega$$

$$*2 R25=R25/R25(1.000)\times 10=10k\Omega$$

$$R85=R85/R25(0.09989)\times R25(10k\Omega)=0.999k\Omega$$

NTCG series **NTCG10 Type**

■ ELECTRICAL CHARACTERISTICS

□ RESISTANCE VS. TEMPERATURE CHARACTERISTICS TABLE (CONVERSION TABLE)

| Temp.(°C) | Resistance-temperature group | | | | | | | | | |
|-----------|------------------------------|---------|--------|--------------------------------------|--------|--------------------------------------|--------|---------|--------|--------------------------------------|
| | G | | H | | J | | K | | U | |
| | RT/R25 | B(25/T) | RT/R25 | B(25/T) | RT/R25 | B(25/T) | RT/R25 | B(25/T) | RT/R25 | B(25/T) |
| -40 | | | 18.850 | 3140 | 35.340 | 3813 | 42.510 | 4010 | 31.059 | 3675 |
| -35 | | | 14.429 | 3159 | 25.280 | 3822 | 30.049 | 4027 | 22.561 | 3688 |
| -30 | | | 11.133 | 3176 | 18.330 | 3834 | 21.489 | 4043 | 16.573 | 3701 |
| -25 | | | 8.656 | 3194 | 13.470 | 3848 | 15.538 | 4059 | 12.304 | 3714 |
| -20 | 13.55 | 4371 | 6.779 | 3210 | 10.010 | 3864 | 11.353 | 4075 | 9.226 | 3727 |
| -15 | 9.833 | 4398 | 5.346 | 3226 | 7.520 | 3882 | 8.378 | 4090 | 6.983 | 3740 |
| -10 | 7.197 | 4424 | 4.245 | 3241 | 5.697 | 3900 | 6.241 | 4105 | 5.333 | 3752 |
| -5 | 5.309 | 4449 | 3.393 | 3256 | 4.352 | 3919 | 4.691 | 4119 | 4.107 | 3765 |
| 0 | 3.947 | 4473 | 2.728 | 3270 | 3.349 | 3937 | 3.556 | 4133 | 3.188 | 3777 |
| 5 | 2.957 | 4496 | 2.207 | 3283 | 2.596 | 3956 | 2.718 | 4147 | 2.494 | 3789 |
| 10 | 2.232 | 4518 | 1.796 | 3296 | 2.026 | 3974 | 2.094 | 4160 | 1.965 | 3801 |
| 15 | 1.696 | 4539 | 1.470 | 3308 | 1.591 | 3989 | 1.625 | 4172 | 1.559 | 3813 |
| 20 | 1.298 | 4559 | 1.209 | 3320 | 1.258 | 4012 | 1.270 | 4185 | 1.245 | 3824 |
| 25 | 1.000 | 4577 | 1.000 | 3332 | 1.000 | 4024 | 1.000 | 4196 | 1.000 | 3835 |
| 30 | 0.7755 | 4596 | 0.831 | 3343 | 0.800 | 4036 | 0.792 | 4208 | 0.808 | 3847 |
| 35 | 0.6052 | 4614 | 0.694 | 3353 | 0.644 | 4049 | 0.632 | 4219 | 0.657 | 3857 |
| 40 | 0.4753 | 4630 | 0.583 | 3363 | 0.521 | 4062 | 0.507 | 4230 | 0.537 | 3868 |
| 45 | 0.3754 | 4646 | 0.491 | 3373 | 0.424 | 4074 | 0.409 | 4240 | 0.441 | 3878 |
| 50 | 0.2983 | 4661 | 0.416 | 3382 ^{*1} (3346 to 3414) | 0.347 | 4085 ^{*2} (3928 to 4171) | 0.332 | 4250 | 0.365 | 3888 ^{*3} (3783 to 4017) |
| 55 | 0.2384 | 4676 | 0.354 | 3390 | 0.285 | 4096 | 0.271 | 4259 | 0.303 | 3898 |
| 60 | 0.1916 | 4690 | 0.302 | 3399 | 0.235 | 4106 | 0.222 | 4269 | 0.252 | 3907 |
| 65 | 0.1548 | 4703 | 0.259 | 3407 | 0.195 | 4115 | 0.183 | 4277 | 0.211 | 3917 |
| 70 | 0.1257 | 4716 | 0.223 | 3414 | 0.163 | 4126 | 0.152 | 4286 | 0.178 | 3925 |
| 75 | 0.1026 | 4728 | 0.192 | 3422 | 0.137 | 4134 | 0.126 | 4293 | 0.150 | 3934 |
| 80 | 0.08412 | 4739 | 0.167 | 3428 | 0.115 | 4142 | 0.106 | 4301 | 0.128 | 3942 |
| 85 | 0.06933 | 4750 | 0.145 | 3435 | 0.0971 | 4150 | 0.0889 | 4308 | 0.109 | 3950 |
| 90 | 0.05740 | 4760 | 0.127 | 3441 | 0.0824 | 4158 | 0.0750 | 4315 | 0.0929 | 3958 |
| 95 | 0.04773 | 4770 | 0.111 | 3447 | 0.0702 | 4165 | 0.0636 | 4321 | 0.0798 | 3965 |
| 100 | 0.03987 | 4780 | 0.0975 | 3453 | 0.0601 | 4172 | 0.0541 | 4327 | 0.0687 | 3972 |
| 105 | 0.03344 | 4789 | 0.0860 | 3458 | 0.0515 | 4179 | 0.0462 | 4332 | 0.0594 | 3978 |
| 110 | 0.02817 | 4797 | 0.0760 | 3463 | 0.0444 | 4186 | 0.0397 | 4338 | 0.0516 | 3985 |
| 115 | 0.02382 | 4806 | 0.0674 | 3468 | 0.0384 | 4193 | 0.0342 | 4342 | 0.0449 | 3990 |
| 120 | 0.02022 | 4813 | 0.0599 | 3473 | 0.0333 | 4199 | 0.0295 | 4347 | 0.0392 | 3996 |
| 125 | 0.01723 | 4821 | 0.0534 | 3478 | 0.0289 | 4206 | 0.0256 | 4351 | 0.0344 | 4001 |

*1 B25/50: 3380±1%

*2 B25/50: 4050±3%

*3 B25/50: 3900±3%

NTCG series **NTCG10 Type** (Narrow tolerance type products)

ELECTRICAL CHARACTERISTICS

CHARACTERISTICS SPECIFICATION TABLE

| Resistance-temperature group | Part No.* | Nominal resistance value [25°C] | B constant | |
|------------------------------|---------------|------------------------------------|------------|-----------|
| | | | [25/85°C] | [25/50°C] |
| H | NTCG103JF103□ | 10kΩ±□% | 3435K±1% | (3380K) |
| J | NTCG104BF473□ | 47kΩ±□% | (4150K) | 4085K±1% |
| K | NTCG104EF104□ | 100kΩ±□% | (4308K) | 4250K±1% |

* The products support narrow tolerance. The "□" of the Part Number contains the nominal resistance tolerance, F (±1%), G (±2%), or H (±3%).

RESISTANCE vs. TEMPERATURE CHARACTERISTICS TABLE (CONVERSION TABLE)

| Temp.(°C) | Resistance-temperature group | | | | | |
|-----------|------------------------------|--------------------------------------|--------|--------------------------------------|--------|---------|
| | H | | J | | K | |
| | RT/R25 | B(25/T) | RT/R25 | B(25/T) | RT/R25 | B(25/T) |
| -40 | 18.850 | 3140 | 35.340 | 3813 | 42.510 | 4010 |
| -35 | 14.429 | 3159 | 25.280 | 3822 | 30.049 | 4027 |
| -30 | 11.133 | 3176 | 18.330 | 3834 | 21.489 | 4043 |
| -25 | 8.656 | 3194 | 13.470 | 3848 | 15.538 | 4059 |
| -20 | 6.779 | 3210 | 10.010 | 3864 | 11.353 | 4075 |
| -15 | 5.346 | 3226 | 7.520 | 3882 | 8.378 | 4090 |
| -10 | 4.245 | 3241 | 5.697 | 3900 | 6.241 | 4105 |
| -5 | 3.393 | 3256 | 4.352 | 3919 | 4.691 | 4119 |
| 0 | 2.728 | 3270 | 3.349 | 3937 | 3.556 | 4133 |
| 5 | 2.207 | 3283 | 2.596 | 3956 | 2.718 | 4147 |
| 10 | 1.796 | 3296 | 2.026 | 3974 | 2.094 | 4160 |
| 15 | 1.470 | 3308 | 1.591 | 3989 | 1.625 | 4172 |
| 20 | 1.209 | 3320 | 1.258 | 4012 | 1.270 | 4185 |
| 25 | 1.000 | 3332 | 1.000 | 4024 | 1.000 | 4196 |
| 30 | 0.831 | 3343 | 0.800 | 4036 | 0.792 | 4208 |
| 35 | 0.694 | 3353 | 0.644 | 4049 | 0.632 | 4219 |
| 40 | 0.583 | 3363 | 0.521 | 4062 | 0.507 | 4230 |
| 45 | 0.491 | 3373 | 0.424 | 4074 | 0.409 | 4240 |
| 50 | 0.416 | 3382* ¹ (3346 to 3414) | 0.347 | 4085* ² (3928 to 4171) | 0.332 | 4250 |
| 55 | 0.354 | 3390 | 0.285 | 4096 | 0.271 | 4259 |
| 60 | 0.302 | 3399 | 0.235 | 4106 | 0.222 | 4269 |
| 65 | 0.259 | 3407 | 0.195 | 4115 | 0.183 | 4277 |
| 70 | 0.223 | 3414 | 0.163 | 4126 | 0.152 | 4286 |
| 75 | 0.192 | 3422 | 0.137 | 4134 | 0.126 | 4293 |
| 80 | 0.167 | 3428 | 0.115 | 4142 | 0.106 | 4301 |
| 85 | 0.145 | 3435 | 0.0971 | 4150 | 0.0889 | 4308 |
| 90 | 0.127 | 3441 | 0.0824 | 4158 | 0.0750 | 4315 |
| 95 | 0.111 | 3447 | 0.0702 | 4165 | 0.0636 | 4321 |
| 100 | 0.0975 | 3453 | 0.0601 | 4172 | 0.0541 | 4327 |
| 105 | 0.0860 | 3458 | 0.0515 | 4179 | 0.0462 | 4332 |
| 110 | 0.0760 | 3463 | 0.0444 | 4186 | 0.0397 | 4338 |
| 115 | 0.0674 | 3468 | 0.0384 | 4193 | 0.0342 | 4342 |
| 120 | 0.0599 | 3473 | 0.0333 | 4199 | 0.0295 | 4347 |
| 125 | 0.0534 | 3478 | 0.0289 | 4206 | 0.0256 | 4351 |

*1 B25/50: 3380±1%

*2 B25/50: 4050±3%

NTCG series **NTCG10 Type**

CHARACTERISTICS OF NTC THERMISTORS (EXAMPLE)

Y-axis: Linear

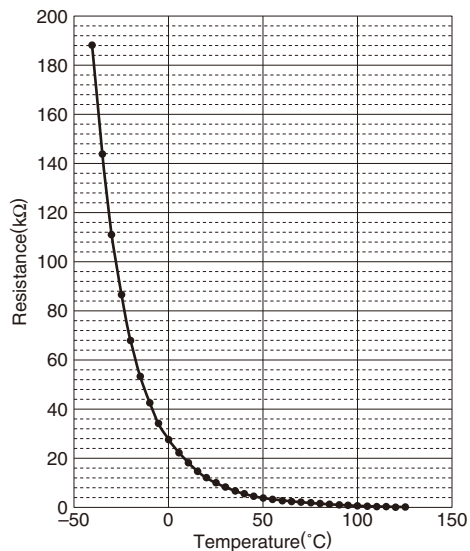

Y-axis: Log.

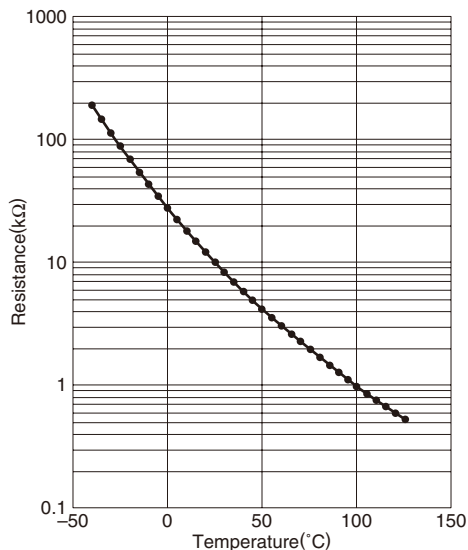

Please be sure to request delivery specifications that provide further details on the features and specifications of the products for proper and safe use. Please note that the contents may change without any prior notice due to reasons such as upgrading.

NTCG series

NTCG16 Type



SHAPE & DIMENSIONS

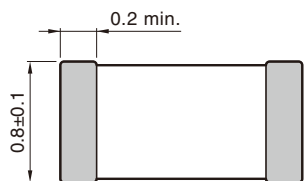
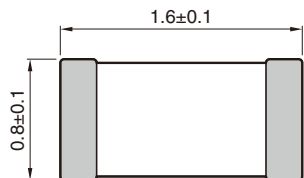

Electrode material
Internal: Pd
External: Ag/Ni/Sn

Dimensions in mm

STRUCTURAL DIAGRAM

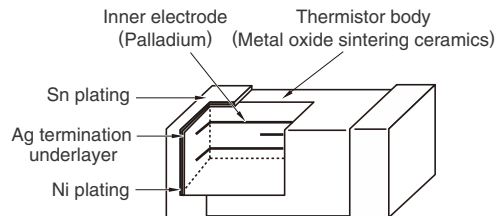

RECOMMENDED LAND PATTERN

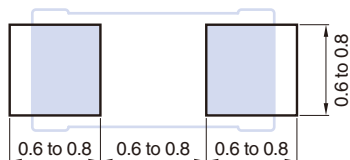

Please be sure to request delivery specifications that provide further details on the features and specifications of the products for proper and safe use. Please note that the contents may change without any prior notice due to reasons such as upgrading.

NTCG series **NTCG16 Type**

■ ELECTRICAL CHARACTERISTICS

□ CHARACTERISTICS SPECIFICATION TABLE

| Resistance-temperature group | Part No.* | Nominal resistance value [25°C] | B constant | |
|------------------------------|---------------|------------------------------------|------------|-----------|
| | | | [25/85°C] | [25/50°C] |
| A | NTCG163EH300□ | 30Ω | 3250K±3% | (3244K) |
| | NTCG163EH400□ | 40Ω | 3250K±3% | (3244K) |
| | NTCG163EH101□ | 100Ω | 3250K±3% | (3244K) |
| C | NTCG164BH102□ | 1.0kΩ | 4100K±3% | (4096K) |
| | NTCG164BH222□ | 2.2kΩ | 4100K±3% | (4096K) |
| E | NTCG164BH332□ | 3.3kΩ | 4100K±3% | (4067K) |
| | NTCG164BH472□ | 4.7kΩ | 4100K±3% | (4067K) |
| | NTCG164BH103□ | 10kΩ | 4100K±3% | (4067K) |
| F | NTCG164LH223□ | 22kΩ | 4550K±3% | (4485K) |
| | NTCG164LH333□ | 33kΩ | 4550K±3% | (4485K) |
| | NTCG164LH473□ | 47kΩ | 4550K±3% | (4485K) |
| | NTCG164LH104□ | 100kΩ | 4550K±3% | (4485K) |
| | NTCG164LH154□ | 150kΩ | 4550K±3% | (4485K) |
| G | NTCG164QH224□ | 220kΩ | 4750K±3% | (4661K) |
| | NTCG164QH334□ | 330kΩ | 4750K±3% | (4661K) |
| | NTCG164QH474□ | 470kΩ | 4750K±3% | (4661K) |
| | NTCG164QH105□ | 1.0MΩ | 4750K±3% | (4661K) |
| H | NTCG163JH103□ | 10kΩ | 3435K±3% | (3380K) |
| J | NTCG164CH473□ | 47kΩ | 4150K±3% | (4050K) |

* The "□" of the Part Number contains the nominal resistance tolerance, H (±3%) or J (±5%). However, in case the nominal resistance value is 30Ω or less, only J can be contained.

NTCG series **NTCG16 Type**

■ ELECTRICAL CHARACTERISTICS

□ RESISTANCE vs. TEMPERATURE CHARACTERISTICS TABLE (CONVERSION TABLE)

| Temp.(°C) | Resistance-temperature group | | | | | | | |
|-----------|------------------------------|---------|---------|---------|-----------------------|---------|---------|---------|
| | A | | C | | E | | F | |
| | RT/R25 | B(25/T) | RT/R25 | B(25/T) | RT/R25 | B(25/T) | RT/R25 | B(25/T) |
| -40 | 19.59 | 3182 | 41.78 | 3991 | 38.44 | 3903 | 50.89 | 4203 |
| -35 | 14.79 | 3188 | 29.45 | 4003 | 27.34 | 3915 | 35.49 | 4224 |
| -30 | 11.28 | 3193 | 21.01 | 4014 | 19.68 | 3928 | 25.03 | 4245 |
| -25 | 8.685 | 3199 | 15.17 | 4024 | 14.33 | 3939 | 17.85 | 4264 |
| -20 | 6.753 | 3204 | 11.07 | 4033 | 10.54 | 3951 | 12.86 | 4284 |
| -15 | 5.298 | 3208 | 8.168 | 4041 | 7.837 | 3962 | 9.353 | 4302 |
| -10 | 4.192 | 3213 | 6.087 | 4049 | 5.883 | 3972 | 6.869 | 4320 |
| -5 | 3.343 | 3217 | 4.581 | 4056 | 4.456 | 3982 | 5.090 | 4337 |
| 0 | 2.687 | 3220 | 3.480 | 4062 | 3.406 | 3992 | 3.805 | 4353 |
| 5 | 2.176 | 3224 | 2.667 | 4068 | 2.625 | 4001 | 2.868 | 4369 |
| 10 | 1.774 | 3227 | 2.062 | 4073 | 2.039 | 4010 | 2.179 | 4384 |
| 15 | 1.456 | 3230 | 1.607 | 4077 | 1.596 | 4018 | 1.669 | 4399 |
| 20 | 1.203 | 3233 | 1.263 | 4081 | 1.259 | 4026 | 1.287 | 4412 |
| 25 | 1.000* ¹ | 3235 | 1.000 | 4084 | 1.000* ² | 4034 | 1.000 | 4426 |
| 30 | 0.8360 | 3237 | 0.7976 | 4088 | 0.7997 | 4041 | 0.7823 | 4439 |
| 35 | 0.7029 | 3239 | 0.6407 | 4090 | 0.6437 | 4048 | 0.6160 | 4451 |
| 40 | 0.5941 | 3241 | 0.5182 | 4092 | 0.5213 | 4055 | 0.4882 | 4463 |
| 45 | 0.5047 | 3243 | 0.4218 | 4094 | 0.4248 | 4061 | 0.3893 | 4474 |
| 50 | 0.4309 | 3244 | 0.3455 | 4096 | 0.3481 | 4067 | 0.3123 | 4485 |
| 55 | 0.3697 | 3246 | 0.2847 | 4097 | 0.2869 | 4072 | 0.2520 | 4496 |
| 60 | 0.3185 | 3247 | 0.2360 | 4098 | 0.2377 | 4078 | 0.2044 | 4506 |
| 65 | 0.2757 | 3248 | 0.1967 | 4099 | 0.1979 | 4083 | 0.1667 | 4515 |
| 70 | 0.2396 | 3248 | 0.1648 | 4099 | 0.1657 | 4087 | 0.1367 | 4524 |
| 75 | 0.2091 | 3249 | 0.1388 | 4100 | 0.1393 | 4092 | 0.1126 | 4533 |
| 80 | 0.1832 | 3250 | 0.1175 | 4100 | 0.1177 | 4096 | 0.09325 | 4542 |
| 85 | 0.1610* ¹ | 3250 | 0.0999 | 4100 | 0.09989* ² | 4100 | 0.07757 | 4550 |
| 90 | 0.1421 | 3250 | 0.0853 | 4100 | 0.08513 | 4104 | 0.06482 | 4558 |
| 95 | 0.1258 | 3251 | 0.0732 | 4100 | 0.07286 | 4107 | 0.05440 | 4565 |
| 100 | 0.1118 | 3251 | 0.0630 | 4100 | 0.06260 | 4110 | 0.04584 | 4573 |
| 105 | 0.09960 | 3251 | 0.05451 | 4100 | 0.05400 | 4114 | 0.03879 | 4580 |
| 110 | 0.08903 | 3251 | 0.04731 | 4100 | 0.04675 | 4116 | 0.03295 | 4586 |
| 115 | 0.07981 | 3251 | 0.04121 | 4101 | 0.04063 | 4119 | 0.02810 | 4593 |
| 120 | 0.07175 | 3251 | 0.03602 | 4101 | 0.03543 | 4122 | 0.02405 | 4599 |
| 125 | 0.06468 | 3251 | 0.03159 | 4101 | 0.03099 | 4124 | 0.02066 | 4606 |

Examples

*¹ R25=R25/R25(1.000)×30=30Ω

R85=R85/R25(0.1610)×R25(30Ω)=4.83Ω

*² R25=R25/R25(1.000)×10=10kΩ

R85=R85/R25(0.09989)×R25(10kΩ)=0.999kΩ

NTCG series **NTCG16 Type**

■ ELECTRICAL CHARACTERISTICS

□ RESISTANCE VS. TEMPERATURE CHARACTERISTICS TABLE (CONVERSION TABLE)

| Temp.(°C) | Resistance-temperature group | | | | | |
|-----------|------------------------------|---------|--------|--------------------------------------|--------|--------------------------------------|
| | G | | H | | J | |
| | RT/R25 | B(25/T) | RT/R25 | B(25/T) | RT/R25 | B(25/T) |
| -40 | | | 18.850 | 3140 | 35.340 | 3813 |
| -35 | | | 14.429 | 3159 | 25.280 | 3822 |
| -30 | | | 11.133 | 3176 | 18.330 | 3834 |
| -25 | | | 8.656 | 3194 | 13.470 | 3848 |
| -20 | 13.55 | 4371 | 6.779 | 3210 | 10.010 | 3864 |
| -15 | 9.833 | 4398 | 5.346 | 3226 | 7.520 | 3882 |
| -10 | 7.197 | 4424 | 4.245 | 3241 | 5.697 | 3900 |
| -5 | 5.309 | 4449 | 3.393 | 3256 | 4.352 | 3919 |
| 0 | 3.947 | 4473 | 2.728 | 3270 | 3.349 | 3937 |
| 5 | 2.957 | 4496 | 2.207 | 3283 | 2.596 | 3956 |
| 10 | 2.232 | 4518 | 1.796 | 3296 | 2.026 | 3974 |
| 15 | 1.696 | 4539 | 1.470 | 3308 | 1.591 | 3989 |
| 20 | 1.298 | 4559 | 1.209 | 3320 | 1.258 | 4012 |
| 25 | 1.000 | 4577 | 1.000 | 3332 | 1.000 | 4024 |
| 30 | 0.7755 | 4596 | 0.831 | 3343 | 0.800 | 4036 |
| 35 | 0.6052 | 4614 | 0.694 | 3353 | 0.644 | 4049 |
| 40 | 0.4753 | 4630 | 0.583 | 3363 | 0.521 | 4062 |
| 45 | 0.3754 | 4646 | 0.491 | 3373 | 0.424 | 4074 |
| 50 | 0.2983 | 4661 | 0.416 | 3382* ¹ (3346 to 3414) | 0.347 | 4085* ² (3928 to 4171) |
| 55 | 0.2384 | 4676 | 0.354 | 3390 | 0.285 | 4096 |
| 60 | 0.1916 | 4690 | 0.302 | 3399 | 0.235 | 4106 |
| 65 | 0.1548 | 4703 | 0.259 | 3407 | 0.195 | 4115 |
| 70 | 0.1257 | 4716 | 0.223 | 3414 | 0.163 | 4126 |
| 75 | 0.1026 | 4728 | 0.192 | 3422 | 0.137 | 4134 |
| 80 | 0.08412 | 4739 | 0.167 | 3428 | 0.115 | 4142 |
| 85 | 0.06933 | 4750 | 0.145 | 3435 | 0.0971 | 4150 |
| 90 | 0.05740 | 4760 | 0.127 | 3441 | 0.0824 | 4158 |
| 95 | 0.04773 | 4770 | 0.111 | 3447 | 0.0702 | 4165 |
| 100 | 0.03987 | 4780 | 0.0975 | 3453 | 0.0601 | 4172 |
| 105 | 0.03344 | 4789 | 0.0860 | 3458 | 0.0515 | 4179 |
| 110 | 0.02817 | 4797 | 0.0760 | 3463 | 0.0444 | 4186 |
| 115 | 0.02382 | 4806 | 0.0674 | 3468 | 0.0384 | 4193 |
| 120 | 0.02022 | 4813 | 0.0599 | 3473 | 0.0333 | 4199 |
| 125 | 0.01723 | 4821 | 0.0534 | 3478 | 0.0289 | 4206 |

*¹ B25/50: 3380±1%*² B25/50: 4050±3%

NTCG series **NTCG16 Type** (Narrow tolerance type products)

ELECTRICAL CHARACTERISTICS

CHARACTERISTICS SPECIFICATION TABLE

| Resistance-temperature group | Part No.* | Nominal resistance value [25°C] | B constant | |
|------------------------------|---------------|------------------------------------|------------|-----------|
| | | | [25/85°C] | [25/50°C] |
| H | NTCG163JF103□ | 10kΩ±□% | 3435K±1% | (3380K) |

* The products support narrow tolerance. The " □ " of the Part Number contains the nominal resistance tolerance, F (±1%), G (±2%), or H (±3%).

RESISTANCE vs. TEMPERATURE CHARACTERISTICS TABLE (CONVERSION TABLE)

| Temp.(°C) | Resistance-temperature group | | | | | |
|-----------|------------------------------|--------------------------------------|--------|--------------------------------------|--------|---------|
| | H | | J | | K | |
| | RT/R25 | B(25/T) | RT/R25 | B(25/T) | RT/R25 | B(25/T) |
| -40 | 18.850 | 3140 | 35.340 | 3813 | 42.510 | 4010 |
| -35 | 14.429 | 3159 | 25.280 | 3822 | 30.049 | 4027 |
| -30 | 11.133 | 3176 | 18.330 | 3834 | 21.489 | 4043 |
| -25 | 8.656 | 3194 | 13.470 | 3848 | 15.538 | 4059 |
| -20 | 6.779 | 3210 | 10.010 | 3864 | 11.353 | 4075 |
| -15 | 5.346 | 3226 | 7.520 | 3882 | 8.378 | 4090 |
| -10 | 4.245 | 3241 | 5.697 | 3900 | 6.241 | 4105 |
| -5 | 3.393 | 3256 | 4.352 | 3919 | 4.691 | 4119 |
| 0 | 2.728 | 3270 | 3.349 | 3937 | 3.556 | 4133 |
| 5 | 2.207 | 3283 | 2.596 | 3956 | 2.718 | 4147 |
| 10 | 1.796 | 3296 | 2.026 | 3974 | 2.094 | 4160 |
| 15 | 1.470 | 3308 | 1.591 | 3989 | 1.625 | 4172 |
| 20 | 1.209 | 3320 | 1.258 | 4012 | 1.270 | 4185 |
| 25 | 1.000 | 3332 | 1.000 | 4024 | 1.000 | 4196 |
| 30 | 0.831 | 3343 | 0.800 | 4036 | 0.792 | 4208 |
| 35 | 0.694 | 3353 | 0.644 | 4049 | 0.632 | 4219 |
| 40 | 0.583 | 3363 | 0.521 | 4062 | 0.507 | 4230 |
| 45 | 0.491 | 3373 | 0.424 | 4074 | 0.409 | 4240 |
| 50 | 0.416 | 3382* ¹ (3346 to 3414) | 0.347 | 4085* ² (3928 to 4171) | 0.332 | 4250 |
| 55 | 0.354 | 3390 | 0.285 | 4096 | 0.271 | 4259 |
| 60 | 0.302 | 3399 | 0.235 | 4106 | 0.222 | 4269 |
| 65 | 0.259 | 3407 | 0.195 | 4115 | 0.183 | 4277 |
| 70 | 0.223 | 3414 | 0.163 | 4126 | 0.152 | 4286 |
| 75 | 0.192 | 3422 | 0.137 | 4134 | 0.126 | 4293 |
| 80 | 0.167 | 3428 | 0.115 | 4142 | 0.106 | 4301 |
| 85 | 0.145 | 3435 | 0.0971 | 4150 | 0.0889 | 4308 |
| 90 | 0.127 | 3441 | 0.0824 | 4158 | 0.0750 | 4315 |
| 95 | 0.111 | 3447 | 0.0702 | 4165 | 0.0636 | 4321 |
| 100 | 0.0975 | 3453 | 0.0601 | 4172 | 0.0541 | 4327 |
| 105 | 0.0860 | 3458 | 0.0515 | 4179 | 0.0462 | 4332 |
| 110 | 0.0760 | 3463 | 0.0444 | 4186 | 0.0397 | 4338 |
| 115 | 0.0674 | 3468 | 0.0384 | 4193 | 0.0342 | 4342 |
| 120 | 0.0599 | 3473 | 0.0333 | 4199 | 0.0295 | 4347 |
| 125 | 0.0534 | 3478 | 0.0289 | 4206 | 0.0256 | 4351 |

*1 B25/50: 3380±1%

*2 B25/50: 4050±3%

NTCG series **NTCG16 Type**

CHARACTERISTICS OF NTC THERMISTORS (EXAMPLE)

Y-axis: Linear

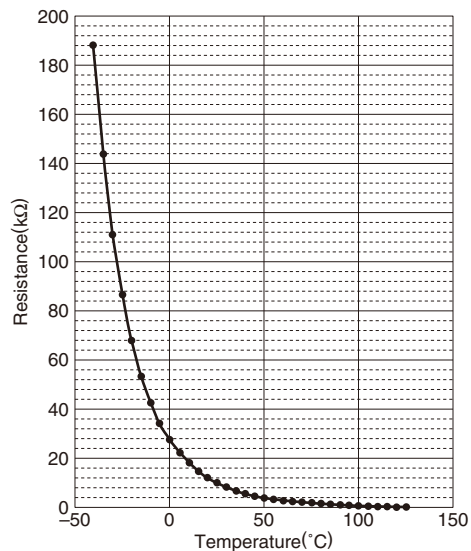

Y-axis: Log.

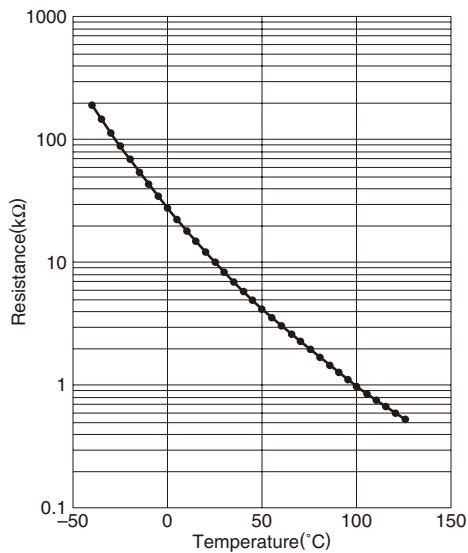

Please be sure to request delivery specifications that provide further details on the features and specifications of the products for proper and safe use. Please note that the contents may change without any prior notice due to reasons such as upgrading.

NTCG series

NTCG20 Type



SHAPE & DIMENSIONS

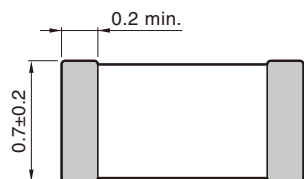
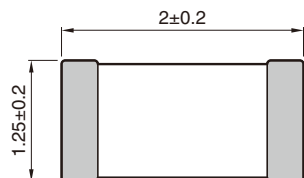

Electrode material
Internal: Pd
External: Ag/Ni/Sn

Dimensions in mm

STRUCTURAL DIAGRAM

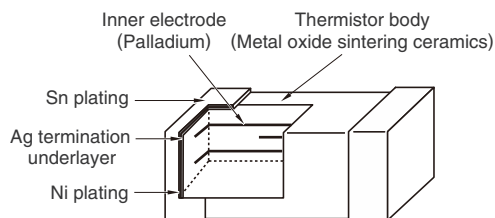

RECOMMENDED LAND PATTERN

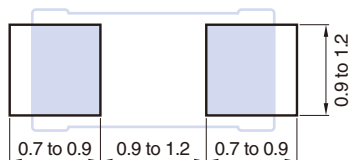

Please be sure to request delivery specifications that provide further details on the features and specifications of the products for proper and safe use. Please note that the contents may change without any prior notice due to reasons such as upgrading.

NTCG series **NTCG20 Type**

■ ELECTRICAL CHARACTERISTICS

□ CHARACTERISTICS SPECIFICATION TABLE

| Resistance-temperature group | Part No.* | Nominal resistance value | B constant | |
|------------------------------|---------------|--------------------------|------------|-----------|
| | | [25°C] | [25/85°C] | [25/50°C] |
| L | NTCG203EH471J | 470Ω±5% | 3250K±3% | (3232K) |
| | NTCG203EH681J | 680Ω±5% | 3250K±3% | (3232K) |
| M | NTCG203BH102J | 1.0kΩ±5% | 3100K±3% | (3060K) |
| | NTCG203BH152J | 1.5kΩ±5% | 3100K±3% | (3060K) |
| N | NTCG203FH222J | 2.2kΩ±5% | 3300K±3% | (3248K) |
| | NTCG203FH332J | 3.3kΩ±5% | 3300K±3% | (3248K) |
| P | NTCG203JH472J | 4.7kΩ±5% | 3450K±3% | (3392K) |
| | NTCG203JH682J | 6.8kΩ±5% | 3450K±3% | (3392K) |
| Q | NTCG203NH103J | 10kΩ±5% | 3650K±3% | (3590K) |
| | NTCG203NH153J | 15kΩ±5% | 3650K±3% | (3590K) |
| R | NTCG203SH223J | 22kΩ±5% | 3850K±3% | (3782K) |
| | NTCG203SH333J | 33kΩ±5% | 3850K±3% | (3782K) |
| S | NTCG204AH473J | 47kΩ±5% | 4000K±3% | (3931K) |
| | NTCG204AH683J | 68kΩ±5% | 4000K±3% | (3931K) |
| T | NTCG204CH104J | 100kΩ±5% | 4150K±3% | (4085K) |
| | NTCG204CH154J | 150kΩ±5% | 4150K±3% | (4085K) |

□ RESISTANCE vs. TEMPERATURE CHARACTERISTICS TABLE (CONVERSION TABLE)

| Temp. (°C) | Resistance-temperature group | | | | | | | | | | | | | | | |
|---------------|------------------------------|---------|--------|---------|---------|---------|--------|---------|--------|---------|--------|---------|--------|---------|--------|---------|
| | L | | M | | N | | P | | Q | | R | | S | | T | |
| | RT/R25 | B(25/T) | RT/R25 | B(25/T) | RT/R25 | B(25/T) | RT/R25 | B(25/T) | RT/R25 | B(25/T) | RT/R25 | B(25/T) | RT/R25 | B(25/T) | RT/R25 | B(25/T) |
| -40 | 17.74 | 3076 | 15.18 | 2909 | 17.65 | 3070 | 19.80 | 3193 | 23.36 | 3370 | 27.76 | 3554 | 31.77 | 3699 | 35.34 | 3813 |
| -35 | 13.62 | 3091 | 11.78 | 2919 | 13.52 | 3082 | 15.00 | 3205 | 17.42 | 3382 | 20.43 | 3570 | 23.02 | 3712 | 25.28 | 3822 |
| -30 | 10.54 | 3105 | 9.217 | 2928 | 10.45 | 3094 | 11.47 | 3216 | 13.13 | 3394 | 15.18 | 3585 | 16.88 | 3725 | 18.33 | 3834 |
| -25 | 8.226 | 3118 | 7.273 | 2936 | 8.150 | 3104 | 8.853 | 3227 | 9.994 | 3406 | 11.39 | 3599 | 12.50 | 3738 | 13.47 | 3848 |
| -20 | 6.466 | 3131 | 5.786 | 2944 | 6.405 | 3115 | 6.894 | 3238 | 7.679 | 3419 | 8.618 | 3613 | 9.357 | 3751 | 10.01 | 3864 |
| -15 | 5.119 | 3142 | 4.639 | 2953 | 5.073 | 3125 | 5.413 | 3249 | 5.952 | 3432 | 6.582 | 3626 | 7.070 | 3763 | 7.520 | 3882 |
| -10 | 4.081 | 3152 | 3.746 | 2961 | 4.048 | 3134 | 4.283 | 3261 | 4.650 | 3445 | 5.073 | 3640 | 5.391 | 3777 | 5.697 | 3900 |
| -5 | 3.277 | 3163 | 3.047 | 2969 | 3.254 | 3144 | 3.415 | 3273 | 3.661 | 3458 | 3.937 | 3652 | 4.147 | 3790 | 4.352 | 3919 |
| 0 | 2.647 | 3171 | 2.494 | 2977 | 2.633 | 3154 | 2.740 | 3284 | 2.903 | 3472 | 3.080 | 3665 | 3.215 | 3804 | 3.349 | 3937 |
| 5 | 2.153 | 3180 | 2.054 | 2985 | 2.145 | 3163 | 2.215 | 3297 | 2.317 | 3484 | 2.427 | 3677 | 2.511 | 3817 | 2.596 | 3956 |
| 10 | 1.762 | 3188 | 1.702 | 2993 | 1.757 | 3173 | 1.800 | 3307 | 1.862 | 3499 | 1.926 | 3690 | 1.975 | 3830 | 2.026 | 3974 |
| 15 | 1.450 | 3195 | 1.418 | 3000 | 1.449 | 3184 | 1.471 | 3319 | 1.505 | 3512 | 1.539 | 3702 | 1.564 | 3843 | 1.591 | 3989 |
| 20 | 1.201 | 3203 | 1.188 | 3011 | 1.200 | 3194 | 1.210 | 3329 | 1.223 | 3519 | 1.237 | 3715 | 1.247 | 3856 | 1.258 | 4012 |
| 25 | 1.000*1 | 3207 | 1.000 | 3017 | 1.000*2 | 3202 | 1.000 | 3339 | 1.000 | 3532 | 1.000 | 3727 | 1.000 | 3868 | 1.000 | 4024 |
| 30 | 0.837 | 3211 | 0.846 | 3023 | 0.837 | 3211 | 0.831 | 3350 | 0.822 | 3546 | 0.813 | 3738 | 0.807 | 3881 | 0.800 | 4036 |
| 35 | 0.704 | 3218 | 0.719 | 3031 | 0.704 | 3223 | 0.694 | 3361 | 0.679 | 3557 | 0.665 | 3748 | 0.654 | 3895 | 0.644 | 4049 |
| 40 | 0.596 | 3224 | 0.613 | 3046 | 0.595 | 3232 | 0.582 | 3372 | 0.564 | 3568 | 0.546 | 3762 | 0.534 | 3907 | 0.521 | 4062 |
| 45 | 0.506 | 3227 | 0.526 | 3047 | 0.505 | 3240 | 0.490 | 3383 | 0.470 | 3579 | 0.451 | 3772 | 0.438 | 3919 | 0.424 | 4074 |
| 50 | 0.432 | 3232 | 0.452 | 3060 | 0.430 | 3248 | 0.415 | 3392 | 0.394 | 3590 | 0.375 | 3782 | 0.361 | 3931 | 0.347 | 4085 |
| 55 | 0.371 | 3235 | 0.391 | 3062 | 0.369 | 3255 | 0.352 | 3402 | 0.332 | 3599 | 0.313 | 3793 | 0.299 | 3940 | 0.285 | 4096 |
| 60 | 0.320 | 3237 | 0.339 | 3070 | 0.316 | 3266 | 0.301 | 3411 | 0.280 | 3609 | 0.262 | 3803 | 0.249 | 3951 | 0.235 | 4106 |
| 65 | 0.276 | 3241 | 0.295 | 3077 | 0.273 | 3271 | 0.257 | 3420 | 0.238 | 3618 | 0.220 | 3813 | 0.208 | 3963 | 0.195 | 4115 |
| 70 | 0.240 | 3243 | 0.258 | 3080 | 0.236 | 3279 | 0.221 | 3427 | 0.203 | 3626 | 0.186 | 3823 | 0.174 | 3973 | 0.163 | 4126 |
| 75 | 0.209 | 3246 | 0.226 | 3087 | 0.205 | 3285 | 0.191 | 3436 | 0.174 | 3635 | 0.158 | 3832 | 0.147 | 3982 | 0.137 | 4134 |
| 80 | 0.183 | 3248 | 0.199 | 3091 | 0.179 | 3292 | 0.166 | 3443 | 0.149 | 3642 | 0.134 | 3841 | 0.124 | 3991 | 0.115 | 4142 |
| 85 | 0.161*1 | 3250 | 0.175 | 3102 | 0.156*2 | 3302 | 0.144 | 3451 | 0.129 | 3650 | 0.115 | 3850 | 0.106 | 4000 | 0.0971 | 4150 |
| 90 | 0.142 | 3252 | 0.155 | 3105 | 0.137 | 3308 | 0.126 | 3457 | 0.111 | 3657 | 0.0986 | 3858 | 0.0901 | 4008 | 0.0824 | 4158 |
| 95 | 0.126 | 3253 | 0.138 | 3106 | 0.121 | 3313 | 0.110 | 3461 | 0.0967 | 3663 | 0.0850 | 3866 | 0.0772 | 4016 | 0.0702 | 4165 |
| 100 | 0.111 | 3255 | 0.123 | 3109 | 0.107 | 3318 | 0.0966 | 3467 | 0.0842 | 3671 | 0.0734 | 3874 | 0.0664 | 4023 | 0.0601 | 4172 |
| 105 | 0.0992 | 3256 | 0.110 | 3111 | 0.0945 | 3324 | 0.0851 | 3472 | 0.0737 | 3675 | 0.0637 | 3881 | 0.0573 | 4030 | 0.0515 | 4179 |
| 110 | 0.0886 | 3257 | 0.0980 | 3122 | 0.0841 | 3327 | 0.0751 | 3479 | 0.0646 | 3682 | 0.0554 | 3888 | 0.0496 | 4036 | 0.0444 | 4186 |
| 115 | 0.0793 | 3258 | 0.0880 | 3125 | 0.0750 | 3331 | 0.0666 | 3484 | 0.0569 | 3686 | 0.0484 | 3895 | 0.0431 | 4042 | 0.0384 | 4193 |
| 120 | 0.0713 | 3259 | 0.0790 | 3132 | 0.0668 | 3339 | 0.0594 | 3485 | 0.0502 | 3691 | 0.0424 | 3901 | 0.0376 | 4047 | 0.0333 | 4199 |
| 125 | 0.0642 | 3260 | 0.0720 | 3123 | 0.0600 | 3340 | 0.0530 | 3487 | 0.0445 | 3695 | 0.0372 | 3906 | 0.0329 | 4053 | 0.0289 | 4206 |

Examples

*1 R25=R25/R25(1.000)×470=470Ω *2 R25=R25/R25(1.000)×3.3=3.3kΩ
 R85=R85/R25(0.161)×R25(470Ω)=75.67Ω R85=R85/R25(0.156)×R25(3.3kΩ)=0.5148kΩ

 Please be sure to request delivery specifications that provide further details on the features and specifications of the products for proper and safe use. Please note that the contents may change without any prior notice due to reasons such as upgrading.

NTCG series **NTCG20 Type**

CHARACTERISTICS OF NTC THERMISTORS (EXAMPLE)

Y-axis: Linear

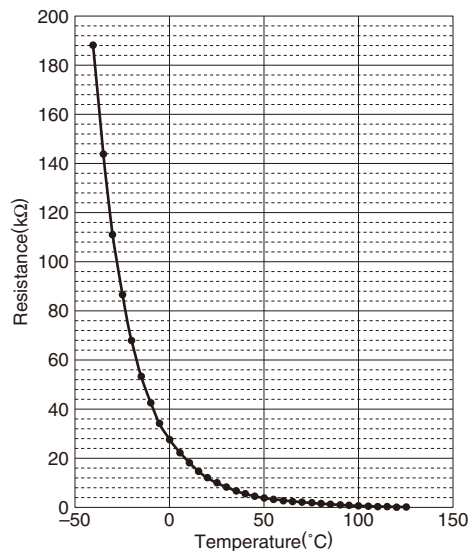

Y-axis: Log.

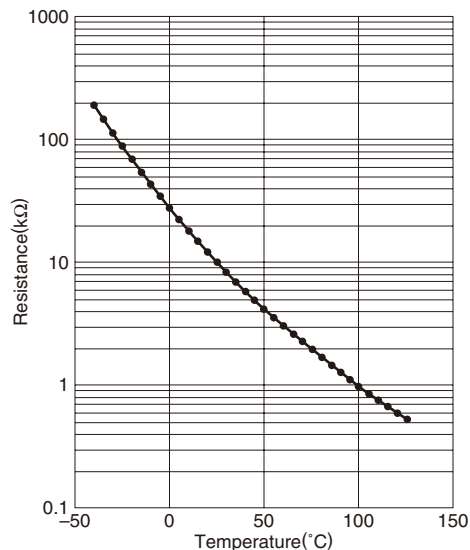

Please be sure to request delivery specifications that provide further details on the features and specifications of the products for proper and safe use. Please note that the contents may change without any prior notice due to reasons such as upgrading.

NTCG series

Packaging Style

REEL DIMENSIONS

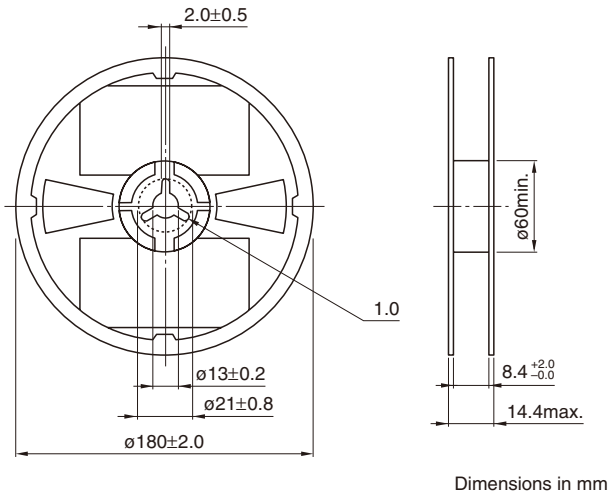

TAPE DIMENSIONS

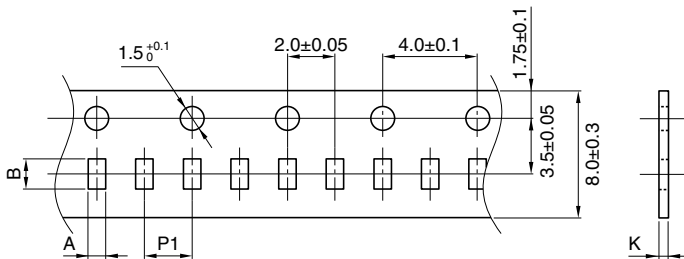

| Type | A | B | P1 | K |
|--------|----------------|----------------|--------|----------|
| NTCG06 | 0.38±0.05 | 0.68±0.05 | 2±0.05 | 0.45max. |
| NTCG10 | 0.65+0.05/-0.1 | 1.15+0.05/-0.1 | 2±0.05 | 0.7max. |
| NTCG16 | 1.1±0.2 | 1.9±0.2 | 4±0.1 | 1.1max. |
| NTCG20 | 1.5±0.2 | 2.3±0.2 | 4±0.1 | 1.1max. |

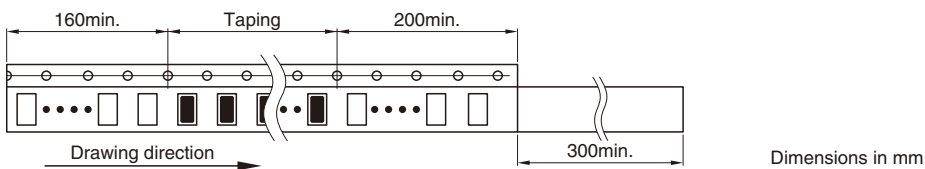

Please be sure to request delivery specifications that provide further details on the features and specifications of the products for proper and safe use. Please note that the contents may change without any prior notice due to reasons such as upgrading.