



NTC Thermistors

SMD

NTCG series

NTCG06	0603 [0201 inch]*
NTCG10	1005 [0402 inch]
NTCG16	1608 [0603 inch]
NTCG20	2012 [0805 inch]

* Dimensions Code JIS[EIA]

REMINDERS FOR USING THESE PRODUCTS

Before using these products, be sure to request the delivery specifications.

SAFETY REMINDERS

Please pay sufficient attention to the warnings for safe designing when using these products.

REMINDERS

Please pay careful attention to the precautions and follow safe designing practices when using these products. Incorrect usage may lead to destroyed NTC thermistors and damages or malfunctions with the devices used.

- Please use them within the ranges of the ratings and performance provided in the Catalog and delivery specifications upon confirming the environments where they are to be used and installed.
- Do not use them outside the operating temperature range.
- Do not use them with the ratings or maximum permissible power levels exceeded.
- Do not quickly apply 5mW or more of load with the constant-voltage power supply in the NTC thermistor as this may lead to staying in thermal runaway mode or the red-shortening of chips.
- Please be cautious of the applied voltage in thermistors as instruments may malfunction with the lowering of resistance due to self heating.
- With instruments that consumers can touch the thermistors with their hands, please carefully warn them not to touch the thermistors.
- Store them in locations where the temperature is -10°C to $+40^{\circ}\text{C}$ and the relative humidity is 75% or below, avoid environments where there are sudden changes in temperatures, direct sunlight, corrosive gas, grit, or dust, and keep them packed in a manner where no loading stress is applied in order to avoid deterioration and damage. (Please use them within six months.)
- When sealing thermistors, please do so upon first considering the type, quantity, hardening conditions, and adhesiveness of the sealing material and confirming its reliability.
- Avoid powerful vibrations, impact (such as by dropping), pressure, etc. on thermistors that exceed the prescribed levels.
- Do not use them for long periods of time in environments with a relative humidity of over 85%. (This excludes cases where countermeasures have been taken.)
- Do not use them in the following environments. (This excludes cases where countermeasures have been taken.)
 - Environments with corrosive gas (Cl_2 , NH_3 , SO_x , NO_x , etc.)
 - Environments with highly conductive substances (electrolytes, water, saltwater, etc.)
 - Environments with acid, alkali, or organic solvents
 - Dusty areas
- Please observe the following precautions when attaching them to substrates as failure to do so may result in destruction or malfunction.
 - Do not let the substrates get warped or twisted at any time during the soldering.
 - The landing size must be even on both the left and right sides.
 - Do not use items that have been dropped or detached.
 - Do not allow the adherence of more solder than needed.
- Reflow mounting is recommended with NTC thermistors, and not flow (dip) mounting.
- Attaching or making corrections with a soldering iron is not recommended as it can lead to troubles such as significant distorting due to thermal shock or cracking. If a soldering iron must be used, it should be 30W or below with the temperature of the tip at 350°C or below, and at a maximum of 5 seconds of soldering time. Also, do not let the tip of the soldering iron come in direct contact with the chips.
- When attaching or making corrections with a soldering iron, the temperature of the tip of the soldering iron should be 350°C or below at a maximum of 5 seconds of soldering time. Do not let the tip of the soldering iron come in directly come in contact with the chips as doing so may lead to particularly large distortions due to thermal shock or cracking.
- Please use a substance such as resin that does not generate hydrogen (H_2) when forming insulation film over chips.
- Please contact our sales offices when considering the use of the products listed on this catalog for applications, whose performance and/or quality require a more stringent level of safety or reliability, or whose failure, malfunction or trouble could cause serious damage to society, person or property ('specific uses' such as automobiles, airplanes, medical instruments, nuclear devices, etc.) as well as when considering the use for applications that exceed the range and conditions of this catalog.

Please note that we are not responsible for any damages or losses incurred resulting from the use of these products that exceeds the range and conditions of this catalog or specific uses.

Please take appropriate measures such as acquiring protective circuits and devices that meet the uses, applications, and conditions of the instruments and keeping backup circuits.

NTC Thermistors

Product compatible with RoHS directive
Compatible with lead-free solders

SMD

Overview of the NTCG Series

CHARACTERISTICS OF NTC THERMISTORS (EXAMPLE)

NTC(Negative Temperature Coefficient) Thermistors are manufactured from sintered metal oxides. Each thermistor consists of a combination of two to four of the following materials: Manganese, Nickel, Cobalt and Copper. NTC thermistors are semiconductor resistors that exhibit decreasing resistance characteristics with increasing temperature. TDK thermistors have low thermal time constants which result in extremely high rates of resistance change to accurately track the temperature.

FEATURES

- Small sized 0603 type (L0.6× W0.3× T0.3mm) series are available.
- Lead (Pb) free product. By using lead-less terminal electrodes and electroplating (Ni-Sn), this product realized excellent solderability and soldering heat resistance, comparing with the conventional eutectic mixture solder and lead-free solder (Sn/Ag/Cu, etc.).
- Product series provides a wide range of resistances and B constants. Good stability of resistance value after soldering. The 0603, 1005, 1608 and 2012 size provide 4 different shapes with identical resistance-temperature characteristics. Attains less than low floating capacitance (using TCXO) in the high frequency region.

APPLICATION

- Temperature sensor
- Temperature compensation

TYPICAL USED SET AND TDK PRODUCT NAMES

Used set	Applied circuit	Resistance (R25)	B constant (B25/85)	TDK recommended part number	
Mobile communication devices	TCXO(Temperature compensated crystal oscillator)	Low-temperature area compensated circuit	30Ω to 100Ω	3250K(2800K)	NTCG103EH400H
		High-temperature area compensated circuit	1.0kΩ to 3.0kΩ	4100K to 4500K	NTCG104BH102H
	Power amplifier module	Power amplifier temperature compensated circuit	30Ω to 10kΩ	3250K to 4500K	NTCG104KH202J
	LCD	LCD temperature compensated circuit	22kΩ to 1MΩ	4550K to 4750K	NTCG104LH473J
	Temperature monitor	Various-circuit temperature compensated circuit	10kΩ to 470kΩ	4100K to 4750K	NTCG104BH103J
Battery pack	Battery temperature monitor and charging control circuit	10kΩ to 100kΩ	3435K to 4550K	NTCG103JF103F	
Computer devices	CPU	CPU temperature monitor	10kΩ to 1MΩ	3435K to 4550K	NTCG103JF103F
	LCD	LCD temperature compensated circuit	22kΩ to 1MΩ	4550K to 4750K	NTCG104LH473J
	HDD	Pickup temperature compensated circuit	10kΩ to 100kΩ	3435K to 4550K	NTCG103JF103F
					NTCG104EF104F
	ODD	CD or DVD write current compensated circuit	10kΩ to 100kΩ	3435K to 4550K	NTCG103JF103F
	Battery pack	Battery temperature monitor and charging control circuit	10kΩ to 100kΩ	3435K to 4550K	NTCG103JF103F
DVC, DSC	Auto focus	Driving circuit temperature compensated circuit	1.0kΩ to 15kΩ	3435K to 4100K	NTCG104BH103J
	Iris stop	Hole element temperature compensated circuit	10kΩ to 100kΩ	3435K to 4550K	NTCG104LH473J
	Battery pack	Battery temperature monitor and charging control circuit	10kΩ to 100kΩ	3435K to 4550K	NTCG103JF103F
Car audio unit	Car CD or MD	Laser pickup temperature compensated circuit	22kΩ to 150kΩ	4550K	NTCG104LH473J
Optical transmission system		Laser transmitter or receiver temperature compensated circuit	1.0kΩ to 150kΩ	4100K to 4550K	NTCG104LH154J
Printer		Ink viscosity controller	10kΩ to 47kΩ	3435K to 4550K	NTCG104LH473H

○ RoHS Directive Compliant Product: See the following for more details related to RoHS Directive compliant products. <http://product.tdk.com/en/environment/rohs/>

 Please be sure to request delivery specifications that provide further details on the features and specifications of the products for proper and safe use. Please note that the contents may change without any prior notice due to reasons such as upgrading.

Overview of the NTCG Series

CIRCUIT EXAMPLES

1. CELLULAR PHONE, TABLET TERMINAL



2. HARD DISK DRIVE

Chip NTC thermistor

NTCG06, NTCG10 types

Resistance tolerance: ± 1 to $\pm 5\%$ /B constant tolerance: ± 1 to $\pm 3\%$

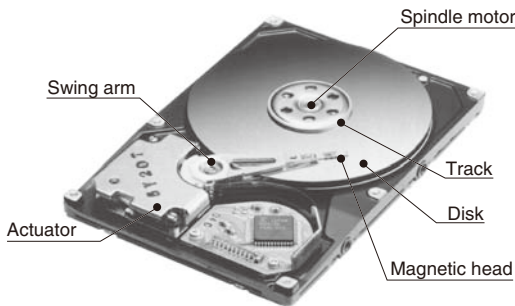

TEMPERATURE SENSOR IC

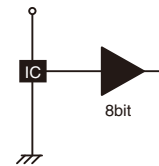

NTC THERMISTOR

(Cost: about 50% down)



Voltage vs. temperature characteristics

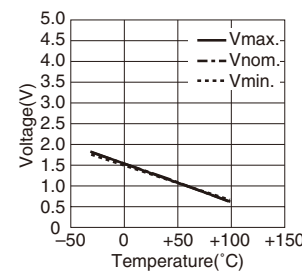

3. BATTERY PACK

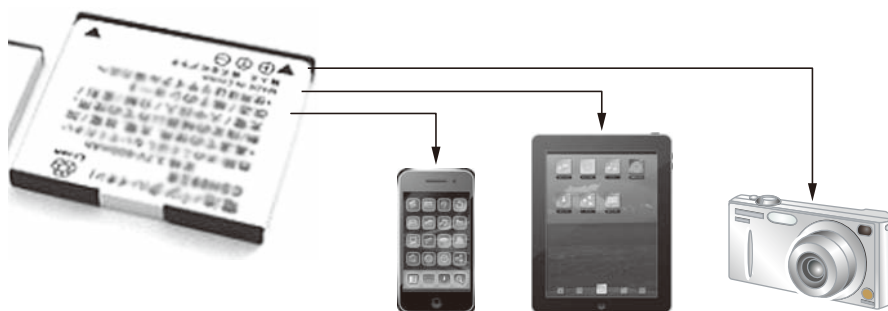

Control circuit for quick charge battery

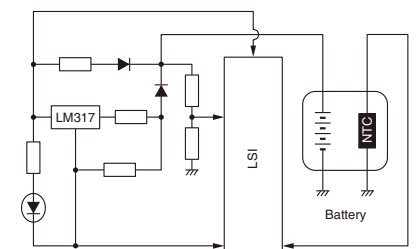

Please be sure to request delivery specifications that provide further details on the features and specifications of the products for proper and safe use. Please note that the contents may change without any prior notice due to reasons such as upgrading.

Overview of the NTCG Series

RESISTANCE VALUE RANGE

Resistance Type	10Ω	100Ω	1kΩ	10kΩ	100kΩ	1MΩ
NTCG06	30Ω					1MΩ
NTCG10	30Ω					1MΩ
NTCG16	30Ω					1MΩ
NTCG20		470Ω				150kΩ

LIST OF SERIES BY TYPE

Type	B constant(K)	Nominal resistance(Ω) [at 25°C]					
		10Ω	100Ω	1kΩ	10kΩ	100kΩ	1MΩ
NTCG06 NTCG10 NTCG16	2800K			100Ω			
	3250K	30Ω		150Ω			
	3435K				10kΩ		
	3650K		220Ω	680Ω			
	4100K			1.0kΩ	3.0kΩ		
	4100K				3.3kΩ	15kΩ	
	4550K				(0603 type: 33kΩ min.)	22kΩ	150kΩ
	4750K					220kΩ	1MΩ
4500K				2.0kΩ	3.0kΩ		
NTCG20	3250K		470Ω	680Ω			
	3100K			1.0kΩ	1.5kΩ		
	3300K			2.2kΩ	3.3kΩ		
	3450K				4.7kΩ	6.8kΩ	
	3650K				10kΩ	15kΩ	
	3850K					22kΩ	33kΩ
	4000K					47kΩ	68kΩ
	4150K					100kΩ	150kΩ

* B constant is calculated from the resistance at 25°C and 85°C

The B constant indicates the magnitude of a change in a zero-load resistance value to a temperature, and is obtained based on arbitrary two temperatures in resistance-to-temperature characteristics.

B constant calculation formula

$$B = \frac{\ln R_1 - \ln R_2}{(1/T_1) - (1/T_2)}$$

B: B Constant (K)

T1: Arbitrary temperature (K)

T2: Arbitrary temperature different from T1 (K)

R1: Zero-load resistance value at temperature T1(Ω)

R2: Zero-load resistance value at temperature T2(Ω)

Each temperature is measured in absolute temperature. 0°C=273.15K

Overview of the NTCG Series

PART NUMBER CONSTRUCTION

NTC	G	○○	3E	H	101	□	T	□							
Series name	Structural classification	Shapes and dimensions code		B constant*		B constant tolerance (%)		Nominal resistance (Ω)		Nominal resistance tolerance** (%)		Packaging style		TDK internal code: Taping specifications	
NTC thermistor	G Multilayer internal electroded chip type NTC thermistor (Pb free type)	06	0603	3E	3201 to 3250	F	±1	300	30	F	±1	T	Taping	1	Standard
		10	1005	3N	3601 to 3650	H	±3	101	100	G	±2	B	Bulk	B	NTCG06 type standard
		16	1608	4L	4501 to 4550			102	1000 (1kΩ)	H	±3			DS	Automotive (High reliability)
		20	2012	4Q	4701 to 4750			103	10000 (10kΩ)	J	±5			1S	150°C correspondence (High reliability)

* The size of the B constant is indicated with a combination of one numeric character and one alphabetic character. Refer to the below for values representing numeric characters and alphabetic characters.

** Resistance tolerance H(±3%) products: NTCG20 type is excluded. For more details, please contact us separately.

Numeric characters (Represent the thousands place of the B constant)		Alphabetic characters (Represent the ones, tens, and hundreds places of the B constant)				
2	2000	A	0 to 50		K	451 to 500
3	3000	B	51 to 100		L	501 to 550
4	4000	C	101 to 150		N	601 to 650
		E	201 to 250		Q	701 to 750
		F	251 to 300		S	801 to 850
		J	401 to 450			

OPERATING TEMPERATURE RANGE, PACKAGE QUANTITY, PRODUCT WEIGHT

Type*	Temperature range		Package quantity	Individual weight
	Operating temperature**	Storage temperature***		
	(°C)	(°C)	(pieces/reel)	(mg)
NTCG06	-40 to +125	-40 to +125	15000	0.3
NTCG10	Standard	-40 to +125	10000	2.5
	High reliability	-40 to +150		
NTCG16	Standard	-40 to +125	4000	5.0
	High reliability	-40 to +150		
NTCG20	-40 to +125	-40 to +125	2000	7.2

* Concerning the "Standard" and "High reliability" of NTCG10 and NTCG16 types, please refer to Taping specifications in PART NUMBER CONSTRUCTION.

** Operating temperature range includes self-temperature rise.

*** The Storage temperature range is for after the circuit board is mounted.

Overview of the NTCG Series

RECOMMENDED REFLOW PROFILE

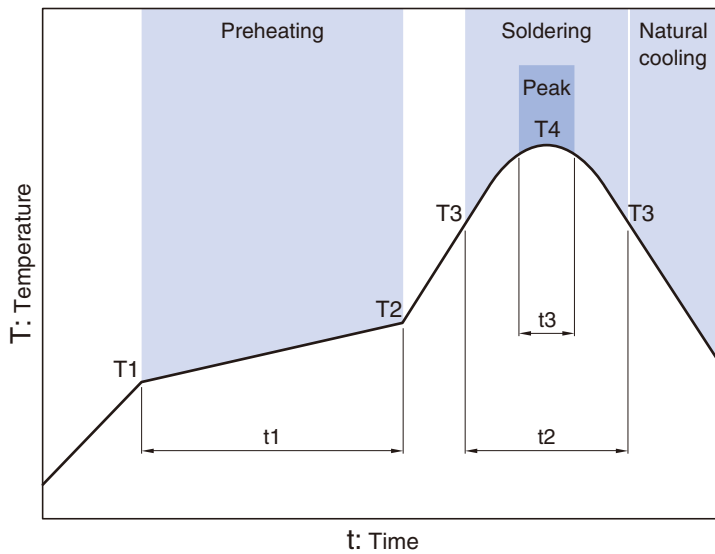

Preheating			Soldering		Peak	
Temp.		Time	Temp.	Time	Temp.	Time
T1	T2	t1	T3	t2	T4	t3
150°C	180°C	60 to 120s	220°C	60s	250 to 260°C	10s max.

NTCG series

NTCG06 Type



■ SHAPE & DIMENSIONS

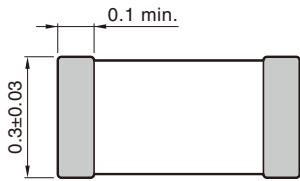
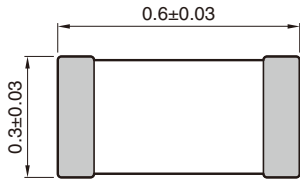

Electrode material
Internal: Pd
External: Ag/Ni/Sn

Dimensions in mm

■ STRUCTURAL DIAGRAM

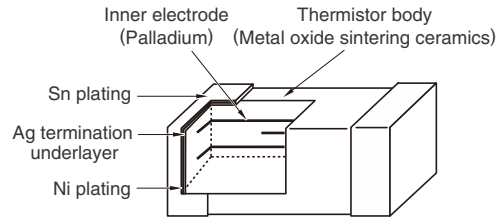

■ RECOMMENDED LAND PATTERN

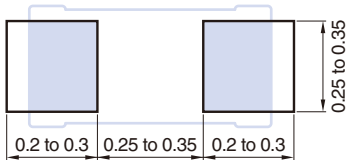

⚠ Please be sure to request delivery specifications that provide further details on the features and specifications of the products for proper and safe use. Please note that the contents may change without any prior notice due to reasons such as upgrading.

NTCG series NTCG06 Type

ELECTRICAL CHARACTERISTICS

CHARACTERISTICS SPECIFICATION TABLE

Resistance-temperature group	Part No.*	Nominal resistance value [25°C]	B constant	
			[25/85°C]	[25/50°C]
A	NTCG063EH300□	30Ω	3250K±3%	(3244K)
	NTCG063EH400□	40Ω	3250K±3%	(3244K)
B	NTCG062QH101□	100Ω	2800K±3%	(2794K)
D	NTCG064KH202□	2.0kΩ	4500K±3%	(4498K)
	NTCG064KH302□	3.0kΩ	4500K±3%	(4498K)
E	NTCG064BH103□	10kΩ	4100K±3%	(4067K)
H	NTCG063JH103□	10kΩ	3435K±3%	(3380K)

* The "□" of the Part Number contains the nominal resistance tolerance, H (±3%) or J (±5%). However, in case the nominal resistance value is 30Ω or less, only J can be contained.

RESISTANCE vs. TEMPERATURE CHARACTERISTICS TABLE (CONVERSION TABLE)

Temp.(°C)	Resistance-temperature group									
	A		B		D		E		H	
	RT/R25	B(25/T)	RT/R25	B(25/T)	RT/R25	B(25/T)	RT/R25	B(25/T)	RT/R25	B(25/T)
-40	19.59	3182	12.65	2714	58.88	4358	38.44	3903	18.850	3140
-35	14.79	3188	9.960	2720	40.29	4374	27.34	3915	14.429	3159
-30	11.28	3193	7.912	2726	27.92	4389	19.68	3928	11.133	3176
-25	8.685	3199	6.337	2732	19.59	4402	14.33	3939	8.656	3194
-20	6.753	3204	5.116	2738	13.90	4415	10.54	3951	6.779	3210
-15	5.298	3208	4.161	2743	9.976	4426	7.837	3962	5.346	3226
-10	4.192	3213	3.408	2749	7.236	4436	5.883	3972	4.245	3241
-5	3.343	3217	2.810	2754	5.303	4446	4.456	3982	3.393	3256
0	2.687	3220	2.332	2759	3.925	4454	3.406	3992	2.728	3270
5	2.176	3224	1.947	2763	2.933	4462	2.625	4001	2.207	3283
10	1.774	3227	1.635	2768	2.212	4469	2.039	4010	1.796	3296
15	1.456	3230	1.381	2772	1.683	4475	1.596	4018	1.470	3308
20	1.203	3233	1.172	2776	1.292	4480	1.259	4026	1.209	3320
25	1.000 ^{*1}	3235	1.000	2780	1.000	4485	1.000 ^{*2}	4034	1.000	3332
30	0.8360	3237	0.857	2783	0.7801	4488	0.7997	4041	0.831	3343
35	0.7029	3239	0.738	2786	0.6133	4492	0.6437	4048	0.694	3353
40	0.5941	3241	0.639	2789	0.4857	4494	0.5213	4055	0.583	3363
45	0.5047	3243	0.555	2792	0.3875	4497	0.4248	4061	0.491	3373
50	0.4309	3244	0.484	2794	0.3112	4498	0.3481	4067	0.416	3382 ^{*3} (3346 to 3414)
55	0.3697	3246	0.424	2796	0.2516	4500	0.2869	4072	0.354	3390
60	0.3185	3247	0.373	2797	0.2048	4501	0.2377	4078	0.302	3399
65	0.2757	3248	0.329	2799	0.1677	4501	0.1979	4083	0.259	3407
70	0.2396	3248	0.292	2799	0.1381	4501	0.1657	4087	0.223	3414
75	0.2091	3249	0.260	2800	0.11439	4501	0.1393	4092	0.192	3422
80	0.1832	3250	0.232	2800	0.09528	4501	0.1177	4096	0.167	3428
85	0.1610 ^{*1}	3250	0.207	2800	0.07978	4500	0.09989 ^{*2}	4100	0.145	3435
90	0.1421	3250	0.186	2799	0.06714	4499	0.08513	4104	0.127	3441
95	0.1258	3251	0.168	2798	0.05679	4498	0.07286	4107	0.111	3447
100	0.1118	3251	0.152	2797	0.04826	4497	0.06260	4110	0.0975	3453
105	0.09960	3251	0.138	2795	0.04119	4495	0.05400	4114	0.0860	3458
110	0.08903	3251	0.125	2793	0.03532	4493	0.04675	4116	0.0760	3463
115	0.07981	3251	0.114	2790	0.03041	4491	0.04063	4119	0.0674	3468
120	0.07175	3251	0.104	2787	0.02629	4489	0.03543	4122	0.0599	3473
125	0.06468	3251	0.096	2783	0.02282	4487	0.03099	4124	0.0534	3478

Examples

^{*1} $R_{25} = R_{25}/R_{25}(1.000) \times 30 = 30\Omega$

^{*2} $R_{25} = R_{25}/R_{25}(1.000) \times 10 = 10k\Omega$

^{*3} $B_{25/50} = 3380 \pm 1\%$

$R_{85} = R_{85}/R_{25}(0.1610) \times R_{25}(30\Omega) = 4.83\Omega$

$R_{85} = R_{85}/R_{25}(0.09989) \times R_{25}(10k\Omega) = 0.999k\Omega$

 Please be sure to request delivery specifications that provide further details on the features and specifications of the products for proper and safe use. Please note that the contents may change without any prior notice due to reasons such as upgrading.

NTCG series **NTCG06 Type** (Narrow tolerance type products)

ELECTRICAL CHARACTERISTICS

CHARACTERISTICS SPECIFICATION TABLE

Resistance-temperature group	Part No.*	Nominal resistance value [25°C]	B constant	
			[25/85°C]	[25/50°C]
H	NTCG063JF103□	10kΩ±□%	3435K±1%	(3380K)
	NTCG064EF104□	100kΩ±□%	(4308K)	4250K±1%

* The products support narrow tolerance. The " □ " of the Part Number contains the nominal resistance tolerance, F (±1%), G (±2%), or H (±3%).

RESISTANCE vs. TEMPERATURE CHARACTERISTICS TABLE (CONVERSION TABLE)

Temp.(°C)	Resistance-temperature group					
	H		J		K	
	RT/R25	B(25/T)	RT/R25	B(25/T)	RT/R25	B(25/T)
-40	18.850	3140	35.340	3813	42.510	4010
-35	14.429	3159	25.280	3822	30.049	4027
-30	11.133	3176	18.330	3834	21.489	4043
-25	8.656	3194	13.470	3848	15.538	4059
-20	6.779	3210	10.010	3864	11.353	4075
-15	5.346	3226	7.520	3882	8.378	4090
-10	4.245	3241	5.697	3900	6.241	4105
-5	3.393	3256	4.352	3919	4.691	4119
0	2.728	3270	3.349	3937	3.556	4133
5	2.207	3283	2.596	3956	2.718	4147
10	1.796	3296	2.026	3974	2.094	4160
15	1.470	3308	1.591	3989	1.625	4172
20	1.209	3320	1.258	4012	1.270	4185
25	1.000	3332	1.000	4024	1.000	4196
30	0.831	3343	0.800	4036	0.792	4208
35	0.694	3353	0.644	4049	0.632	4219
40	0.583	3363	0.521	4062	0.507	4230
45	0.491	3373	0.424	4074	0.409	4240
50	0.416	3382* ¹ (3346 to 3414)	0.347	4085* ² (3928 to 4171)	0.332	4250
55	0.354	3390	0.285	4096	0.271	4259
60	0.302	3399	0.235	4106	0.222	4269
65	0.259	3407	0.195	4115	0.183	4277
70	0.223	3414	0.163	4126	0.152	4286
75	0.192	3422	0.137	4134	0.126	4293
80	0.167	3428	0.115	4142	0.106	4301
85	0.145	3435	0.0971	4150	0.0889	4308
90	0.127	3441	0.0824	4158	0.0750	4315
95	0.111	3447	0.0702	4165	0.0636	4321
100	0.0975	3453	0.0601	4172	0.0541	4327
105	0.0860	3458	0.0515	4179	0.0462	4332
110	0.0760	3463	0.0444	4186	0.0397	4338
115	0.0674	3468	0.0384	4193	0.0342	4342
120	0.0599	3473	0.0333	4199	0.0295	4347
125	0.0534	3478	0.0289	4206	0.0256	4351

*1 B25/50: 3380±1%

*2 B25/50: 4050±3%

NTCG series **NTCG06 Type**

CHARACTERISTICS OF NTC THERMISTORS (EXAMPLE)

Y-axis: Linear

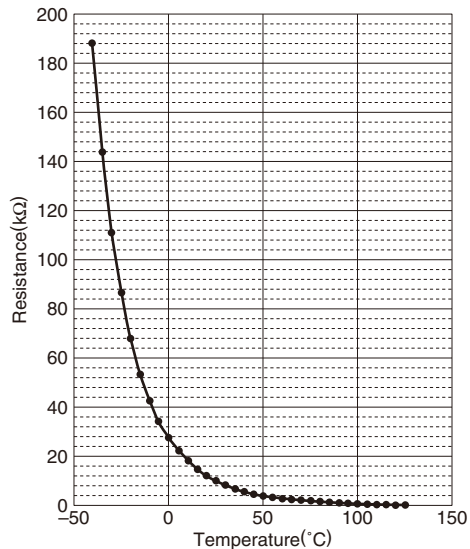

Y-axis: Log.

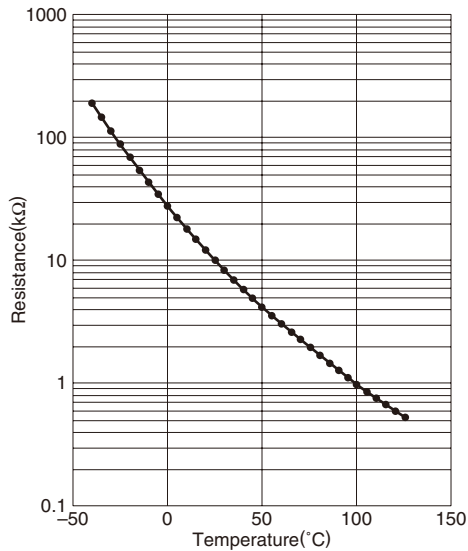

Please be sure to request delivery specifications that provide further details on the features and specifications of the products for proper and safe use. Please note that the contents may change without any prior notice due to reasons such as upgrading.

NTCG series

NTCG10 Type



■ SHAPE & DIMENSIONS

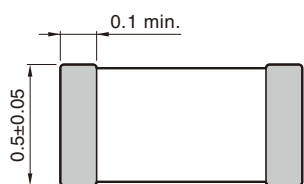
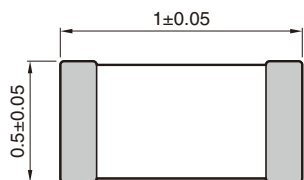

Electrode material
Internal: Pd
External: Ag/Ni/Sn

Dimensions in mm

■ STRUCTURAL DIAGRAM

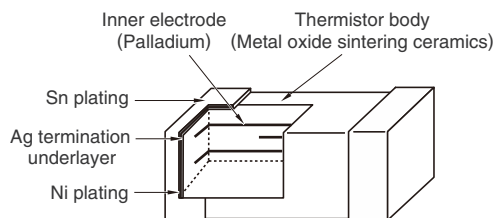

■ RECOMMENDED LAND PATTERN

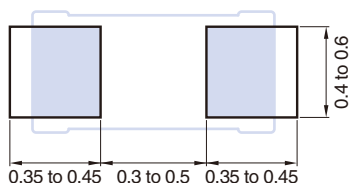

Please be sure to request delivery specifications that provide further details on the features and specifications of the products for proper and safe use. Please note that the contents may change without any prior notice due to reasons such as upgrading.

NTCG series **NTCG10 Type**

■ ELECTRICAL CHARACTERISTICS

□ CHARACTERISTICS SPECIFICATION TABLE

Resistance-temperature group	Part No.*	Nominal resistance value [25°C]	B constant	
			[25/85°C]	[25/50°C]
A	NTCG103EH300□	30Ω	3250K±3%	(3244K)
	NTCG103EH400□	40Ω	3250K±3%	(3244K)
	NTCG103EH101□	100Ω	3250K±3%	(3244K)
C	NTCG104BH102□	1.0kΩ	4100K±3%	(4096K)
	NTCG104BH152□	1.5kΩ	4100K±3%	(4096K)
	NTCG104BH222□	2.2kΩ	4100K±3%	(4096K)
E	NTCG104BH472□	4.7kΩ	4100K±3%	(4067K)
	NTCG104BH682□	6.8kΩ	4100K±3%	(4067K)
	NTCG104BH103□	10kΩ	4100K±3%	(4067K)
F	NTCG104LH223□	22kΩ	4550K±3%	(4485K)
	NTCG104LH333□	33kΩ	4550K±3%	(4485K)
	NTCG104LH473□	47kΩ	4550K±3%	(4485K)
	NTCG104LH683□	68kΩ	4550K±3%	(4485K)
	NTCG104LH104□	100kΩ	4550K±3%	(4485K)
G	NTCG104LH154□	150kΩ	4550K±3%	(4485K)
	NTCG104QH224□	220kΩ	4750K±3%	(4661K)
	NTCG104QH334□	330kΩ	4750K±3%	(4661K)
	NTCG104QH474□	470kΩ	4750K±3%	(4661K)
H	NTCG104QH105□	1.0MΩ	4750K±3%	(4661K)
	NTCG103JH103□	10kΩ	3435K±3%	(3380K)
J	NTCG104BF473□	47kΩ	(4150K)	4085K±1%
	NTCG104BF683□	68kΩ	(4150K)	4085K±1%
K	NTCG104EH104□	100kΩ	(4308K)	4250K±3%
U	NTCG103UH103J	10kΩ	3950K±3%	(3900K)

* The "□" of the Part Number contains the nominal resistance tolerance, H (±3%) or J (±5%). However, in case the nominal resistance value is 30Ω or less, only J can be contained.

NTCG series **NTCG10 Type**

■ ELECTRICAL CHARACTERISTICS

□ RESISTANCE vs. TEMPERATURE CHARACTERISTICS TABLE (CONVERSION TABLE)

Temp.(°C)	Resistance-temperature group							
	A		C		E		F	
	RT/R25	B(25/T)	RT/R25	B(25/T)	RT/R25	B(25/T)	RT/R25	B(25/T)
-40	19.59	3182	41.78	3991	38.44	3903	50.89	4203
-35	14.79	3188	29.45	4003	27.34	3915	35.49	4224
-30	11.28	3193	21.01	4014	19.68	3928	25.03	4245
-25	8.685	3199	15.17	4024	14.33	3939	17.85	4264
-20	6.753	3204	11.07	4033	10.54	3951	12.86	4284
-15	5.298	3208	8.168	4041	7.837	3962	9.353	4302
-10	4.192	3213	6.087	4049	5.883	3972	6.869	4320
-5	3.343	3217	4.581	4056	4.456	3982	5.090	4337
0	2.687	3220	3.480	4062	3.406	3992	3.805	4353
5	2.176	3224	2.667	4068	2.625	4001	2.868	4369
10	1.774	3227	2.062	4073	2.039	4010	2.179	4384
15	1.456	3230	1.607	4077	1.596	4018	1.669	4399
20	1.203	3233	1.263	4081	1.259	4026	1.287	4412
25	1.000* ¹	3235	1.000	4084	1.000* ²	4034	1.000	4426
30	0.8360	3237	0.7976	4088	0.7997	4041	0.7823	4439
35	0.7029	3239	0.6407	4090	0.6437	4048	0.6160	4451
40	0.5941	3241	0.5182	4092	0.5213	4055	0.4882	4463
45	0.5047	3243	0.4218	4094	0.4248	4061	0.3893	4474
50	0.4309	3244	0.3455	4096	0.3481	4067	0.3123	4485
55	0.3697	3246	0.2847	4097	0.2869	4072	0.2520	4496
60	0.3185	3247	0.2360	4098	0.2377	4078	0.2044	4506
65	0.2757	3248	0.1967	4099	0.1979	4083	0.1667	4515
70	0.2396	3248	0.1648	4099	0.1657	4087	0.1367	4524
75	0.2091	3249	0.1388	4100	0.1393	4092	0.1126	4533
80	0.1832	3250	0.1175	4100	0.1177	4096	0.09325	4542
85	0.1610* ¹	3250	0.0999	4100	0.09989* ²	4100	0.07757	4550
90	0.1421	3250	0.0853	4100	0.08513	4104	0.06482	4558
95	0.1258	3251	0.0732	4100	0.07286	4107	0.05440	4565
100	0.1118	3251	0.0630	4100	0.06260	4110	0.04584	4573
105	0.09960	3251	0.05451	4100	0.05400	4114	0.03879	4580
110	0.08903	3251	0.04731	4100	0.04675	4116	0.03295	4586
115	0.07981	3251	0.04121	4101	0.04063	4119	0.02810	4593
120	0.07175	3251	0.03602	4101	0.03543	4122	0.02405	4599
125	0.06468	3251	0.03159	4101	0.03099	4124	0.02066	4606

Examples

*1 $R_{25} = R_{25}/R_{25}(1.000) \times 30 = 30\Omega$

$R_{85} = R_{85}/R_{25}(0.1610) \times R_{25}(30\Omega) = 4.83\Omega$

*2 $R_{25} = R_{25}/R_{25}(1.000) \times 10 = 10k\Omega$

$R_{85} = R_{85}/R_{25}(0.09989) \times R_{25}(10k\Omega) = 0.999k\Omega$

NTCG series **NTCG10 Type**

■ ELECTRICAL CHARACTERISTICS

□ RESISTANCE VS. TEMPERATURE CHARACTERISTICS TABLE (CONVERSION TABLE)

Temp.(°C)	Resistance-temperature group									
	G		H		J		K		U	
	RT/R25	B(25/T)	RT/R25	B(25/T)	RT/R25	B(25/T)	RT/R25	B(25/T)	RT/R25	B(25/T)
-40			18.850	3140	35.340	3813	42.510	4010	31.059	3675
-35			14.429	3159	25.280	3822	30.049	4027	22.561	3688
-30			11.133	3176	18.330	3834	21.489	4043	16.573	3701
-25			8.656	3194	13.470	3848	15.538	4059	12.304	3714
-20	13.55	4371	6.779	3210	10.010	3864	11.353	4075	9.226	3727
-15	9.833	4398	5.346	3226	7.520	3882	8.378	4090	6.983	3740
-10	7.197	4424	4.245	3241	5.697	3900	6.241	4105	5.333	3752
-5	5.309	4449	3.393	3256	4.352	3919	4.691	4119	4.107	3765
0	3.947	4473	2.728	3270	3.349	3937	3.556	4133	3.188	3777
5	2.957	4496	2.207	3283	2.596	3956	2.718	4147	2.494	3789
10	2.232	4518	1.796	3296	2.026	3974	2.094	4160	1.965	3801
15	1.696	4539	1.470	3308	1.591	3989	1.625	4172	1.559	3813
20	1.298	4559	1.209	3320	1.258	4012	1.270	4185	1.245	3824
25	1.000	4577	1.000	3332	1.000	4024	1.000	4196	1.000	3835
30	0.7755	4596	0.831	3343	0.800	4036	0.792	4208	0.808	3847
35	0.6052	4614	0.694	3353	0.644	4049	0.632	4219	0.657	3857
40	0.4753	4630	0.583	3363	0.521	4062	0.507	4230	0.537	3868
45	0.3754	4646	0.491	3373	0.424	4074	0.409	4240	0.441	3878
50	0.2983	4661	0.416	3382 ^{*1} (3346 to 3414)	0.347	4085 ^{*2} (3928 to 4171)	0.332	4250	0.365	3888 ^{*3} (3783 to 4017)
55	0.2384	4676	0.354	3390	0.285	4096	0.271	4259	0.303	3898
60	0.1916	4690	0.302	3399	0.235	4106	0.222	4269	0.252	3907
65	0.1548	4703	0.259	3407	0.195	4115	0.183	4277	0.211	3917
70	0.1257	4716	0.223	3414	0.163	4126	0.152	4286	0.178	3925
75	0.1026	4728	0.192	3422	0.137	4134	0.126	4293	0.150	3934
80	0.08412	4739	0.167	3428	0.115	4142	0.106	4301	0.128	3942
85	0.06933	4750	0.145	3435	0.0971	4150	0.0889	4308	0.109	3950
90	0.05740	4760	0.127	3441	0.0824	4158	0.0750	4315	0.0929	3958
95	0.04773	4770	0.111	3447	0.0702	4165	0.0636	4321	0.0798	3965
100	0.03987	4780	0.0975	3453	0.0601	4172	0.0541	4327	0.0687	3972
105	0.03344	4789	0.0860	3458	0.0515	4179	0.0462	4332	0.0594	3978
110	0.02817	4797	0.0760	3463	0.0444	4186	0.0397	4338	0.0516	3985
115	0.02382	4806	0.0674	3468	0.0384	4193	0.0342	4342	0.0449	3990
120	0.02022	4813	0.0599	3473	0.0333	4199	0.0295	4347	0.0392	3996
125	0.01723	4821	0.0534	3478	0.0289	4206	0.0256	4351	0.0344	4001

*1 B25/50: 3380±1%

*2 B25/50: 4050±3%

*3 B25/50: 3900±3%

NTCG series **NTCG10 Type** (Narrow tolerance type products)

ELECTRICAL CHARACTERISTICS

CHARACTERISTICS SPECIFICATION TABLE

Resistance-temperature group	Part No.*	Nominal resistance value [25°C]	B constant	
			[25/85°C]	[25/50°C]
H	NTCG103JF103□	10kΩ±□%	3435K±1%	(3380K)
J	NTCG104BF473□	47kΩ±□%	(4150K)	4085K±1%
K	NTCG104EF104□	100kΩ±□%	(4308K)	4250K±1%

* The products support narrow tolerance. The "□" of the Part Number contains the nominal resistance tolerance, F (±1%), G (±2%), or H (±3%).

RESISTANCE vs. TEMPERATURE CHARACTERISTICS TABLE (CONVERSION TABLE)

Temp.(°C)	Resistance-temperature group					
	H		J		K	
	RT/R25	B(25/T)	RT/R25	B(25/T)	RT/R25	B(25/T)
-40	18.850	3140	35.340	3813	42.510	4010
-35	14.429	3159	25.280	3822	30.049	4027
-30	11.133	3176	18.330	3834	21.489	4043
-25	8.656	3194	13.470	3848	15.538	4059
-20	6.779	3210	10.010	3864	11.353	4075
-15	5.346	3226	7.520	3882	8.378	4090
-10	4.245	3241	5.697	3900	6.241	4105
-5	3.393	3256	4.352	3919	4.691	4119
0	2.728	3270	3.349	3937	3.556	4133
5	2.207	3283	2.596	3956	2.718	4147
10	1.796	3296	2.026	3974	2.094	4160
15	1.470	3308	1.591	3989	1.625	4172
20	1.209	3320	1.258	4012	1.270	4185
25	1.000	3332	1.000	4024	1.000	4196
30	0.831	3343	0.800	4036	0.792	4208
35	0.694	3353	0.644	4049	0.632	4219
40	0.583	3363	0.521	4062	0.507	4230
45	0.491	3373	0.424	4074	0.409	4240
50	0.416	3382* ¹ (3346 to 3414)	0.347	4085* ² (3928 to 4171)	0.332	4250
55	0.354	3390	0.285	4096	0.271	4259
60	0.302	3399	0.235	4106	0.222	4269
65	0.259	3407	0.195	4115	0.183	4277
70	0.223	3414	0.163	4126	0.152	4286
75	0.192	3422	0.137	4134	0.126	4293
80	0.167	3428	0.115	4142	0.106	4301
85	0.145	3435	0.0971	4150	0.0889	4308
90	0.127	3441	0.0824	4158	0.0750	4315
95	0.111	3447	0.0702	4165	0.0636	4321
100	0.0975	3453	0.0601	4172	0.0541	4327
105	0.0860	3458	0.0515	4179	0.0462	4332
110	0.0760	3463	0.0444	4186	0.0397	4338
115	0.0674	3468	0.0384	4193	0.0342	4342
120	0.0599	3473	0.0333	4199	0.0295	4347
125	0.0534	3478	0.0289	4206	0.0256	4351

*1 B25/50: 3380±1%

*2 B25/50: 4050±3%

NTCG series **NTCG10 Type**

CHARACTERISTICS OF NTC THERMISTORS (EXAMPLE)

Y-axis: Linear



Y-axis: Log.



Please be sure to request delivery specifications that provide further details on the features and specifications of the products for proper and safe use. Please note that the contents may change without any prior notice due to reasons such as upgrading.

NTCG series

NTCG16 Type



SHAPE & DIMENSIONS

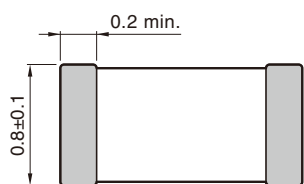
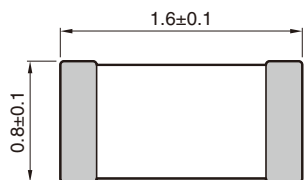

Electrode material
Internal: Pd
External: Ag/Ni/Sn

Dimensions in mm

STRUCTURAL DIAGRAM

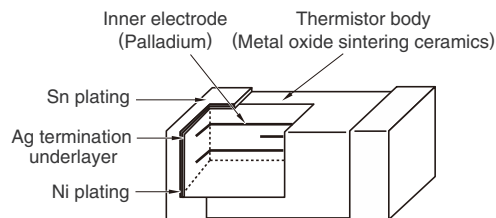

RECOMMENDED LAND PATTERN

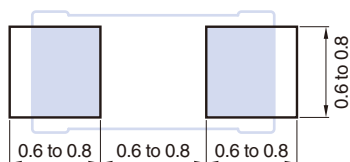

Please be sure to request delivery specifications that provide further details on the features and specifications of the products for proper and safe use. Please note that the contents may change without any prior notice due to reasons such as upgrading.

NTCG series **NTCG16 Type**

■ ELECTRICAL CHARACTERISTICS

□ CHARACTERISTICS SPECIFICATION TABLE

Resistance-temperature group	Part No.*	Nominal resistance value [25°C]	B constant	
			[25/85°C]	[25/50°C]
A	NTCG163EH300□	30Ω	3250K±3%	(3244K)
	NTCG163EH400□	40Ω	3250K±3%	(3244K)
	NTCG163EH101□	100Ω	3250K±3%	(3244K)
C	NTCG164BH102□	1.0kΩ	4100K±3%	(4096K)
	NTCG164BH222□	2.2kΩ	4100K±3%	(4096K)
E	NTCG164BH332□	3.3kΩ	4100K±3%	(4067K)
	NTCG164BH472□	4.7kΩ	4100K±3%	(4067K)
	NTCG164BH103□	10kΩ	4100K±3%	(4067K)
F	NTCG164LH223□	22kΩ	4550K±3%	(4485K)
	NTCG164LH333□	33kΩ	4550K±3%	(4485K)
	NTCG164LH473□	47kΩ	4550K±3%	(4485K)
	NTCG164LH104□	100kΩ	4550K±3%	(4485K)
	NTCG164LH154□	150kΩ	4550K±3%	(4485K)
G	NTCG164QH224□	220kΩ	4750K±3%	(4661K)
	NTCG164QH334□	330kΩ	4750K±3%	(4661K)
	NTCG164QH474□	470kΩ	4750K±3%	(4661K)
	NTCG164QH105□	1.0MΩ	4750K±3%	(4661K)
H	NTCG163JH103□	10kΩ	3435K±3%	(3380K)
J	NTCG164CH473□	47kΩ	4150K±3%	(4050K)

* The "□" of the Part Number contains the nominal resistance tolerance, H (±3%) or J (±5%). However, in case the nominal resistance value is 30Ω or less, only J can be contained.

NTCG series **NTCG16 Type**

■ ELECTRICAL CHARACTERISTICS

□ RESISTANCE vs. TEMPERATURE CHARACTERISTICS TABLE (CONVERSION TABLE)

Temp.(°C)	Resistance-temperature group							
	A		C		E		F	
	RT/R25	B(25/T)	RT/R25	B(25/T)	RT/R25	B(25/T)	RT/R25	B(25/T)
-40	19.59	3182	41.78	3991	38.44	3903	50.89	4203
-35	14.79	3188	29.45	4003	27.34	3915	35.49	4224
-30	11.28	3193	21.01	4014	19.68	3928	25.03	4245
-25	8.685	3199	15.17	4024	14.33	3939	17.85	4264
-20	6.753	3204	11.07	4033	10.54	3951	12.86	4284
-15	5.298	3208	8.168	4041	7.837	3962	9.353	4302
-10	4.192	3213	6.087	4049	5.883	3972	6.869	4320
-5	3.343	3217	4.581	4056	4.456	3982	5.090	4337
0	2.687	3220	3.480	4062	3.406	3992	3.805	4353
5	2.176	3224	2.667	4068	2.625	4001	2.868	4369
10	1.774	3227	2.062	4073	2.039	4010	2.179	4384
15	1.456	3230	1.607	4077	1.596	4018	1.669	4399
20	1.203	3233	1.263	4081	1.259	4026	1.287	4412
25	1.000* ¹	3235	1.000	4084	1.000* ²	4034	1.000	4426
30	0.8360	3237	0.7976	4088	0.7997	4041	0.7823	4439
35	0.7029	3239	0.6407	4090	0.6437	4048	0.6160	4451
40	0.5941	3241	0.5182	4092	0.5213	4055	0.4882	4463
45	0.5047	3243	0.4218	4094	0.4248	4061	0.3893	4474
50	0.4309	3244	0.3455	4096	0.3481	4067	0.3123	4485
55	0.3697	3246	0.2847	4097	0.2869	4072	0.2520	4496
60	0.3185	3247	0.2360	4098	0.2377	4078	0.2044	4506
65	0.2757	3248	0.1967	4099	0.1979	4083	0.1667	4515
70	0.2396	3248	0.1648	4099	0.1657	4087	0.1367	4524
75	0.2091	3249	0.1388	4100	0.1393	4092	0.1126	4533
80	0.1832	3250	0.1175	4100	0.1177	4096	0.09325	4542
85	0.1610* ¹	3250	0.0999	4100	0.09989* ²	4100	0.07757	4550
90	0.1421	3250	0.0853	4100	0.08513	4104	0.06482	4558
95	0.1258	3251	0.0732	4100	0.07286	4107	0.05440	4565
100	0.1118	3251	0.0630	4100	0.06260	4110	0.04584	4573
105	0.09960	3251	0.05451	4100	0.05400	4114	0.03879	4580
110	0.08903	3251	0.04731	4100	0.04675	4116	0.03295	4586
115	0.07981	3251	0.04121	4101	0.04063	4119	0.02810	4593
120	0.07175	3251	0.03602	4101	0.03543	4122	0.02405	4599
125	0.06468	3251	0.03159	4101	0.03099	4124	0.02066	4606

Examples

*¹ R25=R25/R25(1.000)×30=30Ω

R85=R85/R25(0.1610)×R25(30Ω)=4.83Ω

*² R25=R25/R25(1.000)×10=10kΩ

R85=R85/R25(0.09989)×R25(10kΩ)=0.999kΩ

NTCG series **NTCG16 Type**

■ ELECTRICAL CHARACTERISTICS

□ RESISTANCE VS. TEMPERATURE CHARACTERISTICS TABLE (CONVERSION TABLE)

Temp.(°C)	Resistance-temperature group					
	G		H		J	
	RT/R25	B(25/T)	RT/R25	B(25/T)	RT/R25	B(25/T)
-40			18.850	3140	35.340	3813
-35			14.429	3159	25.280	3822
-30			11.133	3176	18.330	3834
-25			8.656	3194	13.470	3848
-20	13.55	4371	6.779	3210	10.010	3864
-15	9.833	4398	5.346	3226	7.520	3882
-10	7.197	4424	4.245	3241	5.697	3900
-5	5.309	4449	3.393	3256	4.352	3919
0	3.947	4473	2.728	3270	3.349	3937
5	2.957	4496	2.207	3283	2.596	3956
10	2.232	4518	1.796	3296	2.026	3974
15	1.696	4539	1.470	3308	1.591	3989
20	1.298	4559	1.209	3320	1.258	4012
25	1.000	4577	1.000	3332	1.000	4024
30	0.7755	4596	0.831	3343	0.800	4036
35	0.6052	4614	0.694	3353	0.644	4049
40	0.4753	4630	0.583	3363	0.521	4062
45	0.3754	4646	0.491	3373	0.424	4074
50	0.2983	4661	0.416	3382* ¹ (3346 to 3414)	0.347	4085* ² (3928 to 4171)
55	0.2384	4676	0.354	3390	0.285	4096
60	0.1916	4690	0.302	3399	0.235	4106
65	0.1548	4703	0.259	3407	0.195	4115
70	0.1257	4716	0.223	3414	0.163	4126
75	0.1026	4728	0.192	3422	0.137	4134
80	0.08412	4739	0.167	3428	0.115	4142
85	0.06933	4750	0.145	3435	0.0971	4150
90	0.05740	4760	0.127	3441	0.0824	4158
95	0.04773	4770	0.111	3447	0.0702	4165
100	0.03987	4780	0.0975	3453	0.0601	4172
105	0.03344	4789	0.0860	3458	0.0515	4179
110	0.02817	4797	0.0760	3463	0.0444	4186
115	0.02382	4806	0.0674	3468	0.0384	4193
120	0.02022	4813	0.0599	3473	0.0333	4199
125	0.01723	4821	0.0534	3478	0.0289	4206

*¹ B25/50: 3380±1%*² B25/50: 4050±3%

NTCG series **NTCG16 Type** (Narrow tolerance type products)

ELECTRICAL CHARACTERISTICS

CHARACTERISTICS SPECIFICATION TABLE

Resistance-temperature group	Part No.*	Nominal resistance value [25°C]	B constant	
			[25/85°C]	[25/50°C]
H	NTCG163JF103□	10kΩ±□%	3435K±1%	(3380K)

* The products support narrow tolerance. The " □ " of the Part Number contains the nominal resistance tolerance, F (±1%), G (±2%), or H (±3%).

RESISTANCE vs. TEMPERATURE CHARACTERISTICS TABLE (CONVERSION TABLE)

Temp.(°C)	Resistance-temperature group					
	H		J		K	
	RT/R25	B(25/T)	RT/R25	B(25/T)	RT/R25	B(25/T)
-40	18.850	3140	35.340	3813	42.510	4010
-35	14.429	3159	25.280	3822	30.049	4027
-30	11.133	3176	18.330	3834	21.489	4043
-25	8.656	3194	13.470	3848	15.538	4059
-20	6.779	3210	10.010	3864	11.353	4075
-15	5.346	3226	7.520	3882	8.378	4090
-10	4.245	3241	5.697	3900	6.241	4105
-5	3.393	3256	4.352	3919	4.691	4119
0	2.728	3270	3.349	3937	3.556	4133
5	2.207	3283	2.596	3956	2.718	4147
10	1.796	3296	2.026	3974	2.094	4160
15	1.470	3308	1.591	3989	1.625	4172
20	1.209	3320	1.258	4012	1.270	4185
25	1.000	3332	1.000	4024	1.000	4196
30	0.831	3343	0.800	4036	0.792	4208
35	0.694	3353	0.644	4049	0.632	4219
40	0.583	3363	0.521	4062	0.507	4230
45	0.491	3373	0.424	4074	0.409	4240
50	0.416	3382* ¹ (3346 to 3414)	0.347	4085* ² (3928 to 4171)	0.332	4250
55	0.354	3390	0.285	4096	0.271	4259
60	0.302	3399	0.235	4106	0.222	4269
65	0.259	3407	0.195	4115	0.183	4277
70	0.223	3414	0.163	4126	0.152	4286
75	0.192	3422	0.137	4134	0.126	4293
80	0.167	3428	0.115	4142	0.106	4301
85	0.145	3435	0.0971	4150	0.0889	4308
90	0.127	3441	0.0824	4158	0.0750	4315
95	0.111	3447	0.0702	4165	0.0636	4321
100	0.0975	3453	0.0601	4172	0.0541	4327
105	0.0860	3458	0.0515	4179	0.0462	4332
110	0.0760	3463	0.0444	4186	0.0397	4338
115	0.0674	3468	0.0384	4193	0.0342	4342
120	0.0599	3473	0.0333	4199	0.0295	4347
125	0.0534	3478	0.0289	4206	0.0256	4351

*1 B25/50: 3380±1%

*2 B25/50: 4050±3%

NTCG series **NTCG16 Type**

■ CHARACTERISTICS OF NTC THERMISTORS (EXAMPLE)

Y-axis: Linear

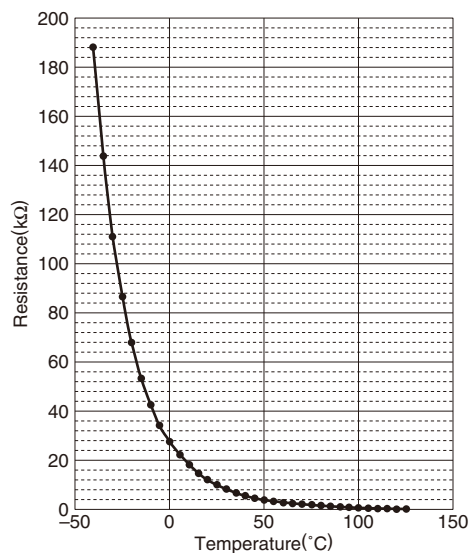

Y-axis: Log.

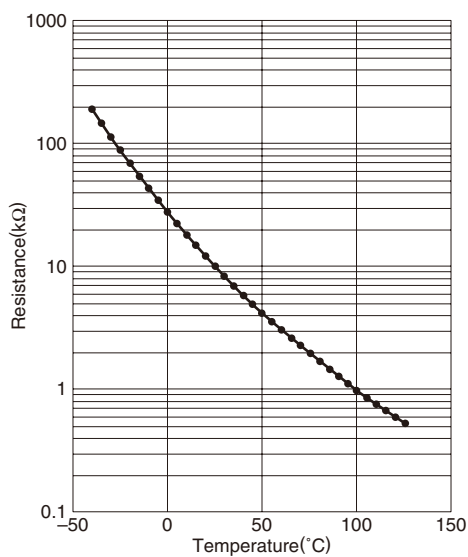

Please be sure to request delivery specifications that provide further details on the features and specifications of the products for proper and safe use. Please note that the contents may change without any prior notice due to reasons such as upgrading.

NTCG series

NTCG20 Type



SHAPE & DIMENSIONS

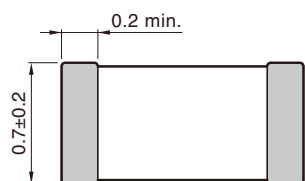
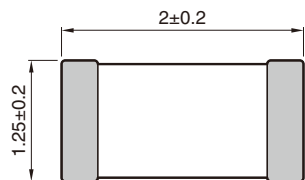

Electrode material
Internal: Pd
External: Ag/Ni/Sn

Dimensions in mm

STRUCTURAL DIAGRAM

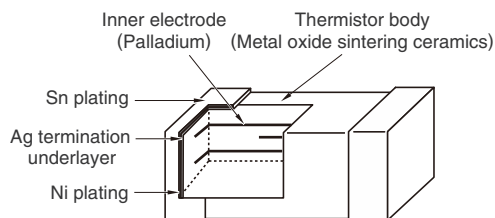

RECOMMENDED LAND PATTERN

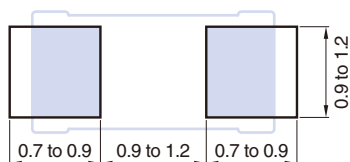

⚠ Please be sure to request delivery specifications that provide further details on the features and specifications of the products for proper and safe use. Please note that the contents may change without any prior notice due to reasons such as upgrading.

NTCG series **NTCG20 Type**

■ ELECTRICAL CHARACTERISTICS

□ CHARACTERISTICS SPECIFICATION TABLE

Resistance-temperature group	Part No.*	Nominal resistance value [25°C]	B constant	
			[25/85°C]	[25/50°C]
L	NTCG203EH471J	470Ω±5%	3250K±3%	(3232K)
	NTCG203EH681J	680Ω±5%	3250K±3%	(3232K)
M	NTCG203BH102J	1.0kΩ±5%	3100K±3%	(3060K)
	NTCG203BH152J	1.5kΩ±5%	3100K±3%	(3060K)
N	NTCG203FH222J	2.2kΩ±5%	3300K±3%	(3248K)
P	NTCG203FH332J	3.3kΩ±5%	3300K±3%	(3248K)
	NTCG203JH472J	4.7kΩ±5%	3450K±3%	(3392K)
Q	NTCG203JH682J	6.8kΩ±5%	3450K±3%	(3392K)
	NTCG203NH103J	10kΩ±5%	3650K±3%	(3590K)
R	NTCG203NH153J	15kΩ±5%	3650K±3%	(3590K)
	NTCG203SH223J	22kΩ±5%	3850K±3%	(3782K)
S	NTCG203SH333J	33kΩ±5%	3850K±3%	(3782K)
	NTCG204AH473J	47kΩ±5%	4000K±3%	(3931K)
T	NTCG204AH683J	68kΩ±5%	4000K±3%	(3931K)
	NTCG204CH104J	100kΩ±5%	4150K±3%	(4085K)
	NTCG204CH154J	150kΩ±5%	4150K±3%	(4085K)

□ RESISTANCE vs. TEMPERATURE CHARACTERISTICS TABLE (CONVERSION TABLE)

Temp. (°C)	Resistance-temperature group															
	L		M		N		P		Q		R		S		T	
	RT/R25	B(25/T)	RT/R25	B(25/T)	RT/R25	B(25/T)	RT/R25	B(25/T)	RT/R25	B(25/T)	RT/R25	B(25/T)	RT/R25	B(25/T)	RT/R25	B(25/T)
-40	17.74	3076	15.18	2909	17.65	3070	19.80	3193	23.36	3370	27.76	3554	31.77	3699	35.34	3813
-35	13.62	3091	11.78	2919	13.52	3082	15.00	3205	17.42	3382	20.43	3570	23.02	3712	25.28	3822
-30	10.54	3105	9.217	2928	10.45	3094	11.47	3216	13.13	3394	15.18	3585	16.88	3725	18.33	3834
-25	8.226	3118	7.273	2936	8.150	3104	8.853	3227	9.994	3406	11.39	3599	12.50	3738	13.47	3848
-20	6.466	3131	5.786	2944	6.405	3115	6.894	3238	7.679	3419	8.618	3613	9.357	3751	10.01	3864
-15	5.119	3142	4.639	2953	5.073	3125	5.413	3249	5.952	3432	6.582	3626	7.070	3763	7.520	3882
-10	4.081	3152	3.746	2961	4.048	3134	4.283	3261	4.650	3445	5.073	3640	5.391	3777	5.697	3900
-5	3.277	3163	3.047	2969	3.254	3144	3.415	3273	3.661	3458	3.937	3652	4.147	3790	4.352	3919
0	2.647	3171	2.494	2977	2.633	3154	2.740	3284	2.903	3472	3.080	3665	3.215	3804	3.349	3937
5	2.153	3180	2.054	2985	2.145	3163	2.215	3297	2.317	3484	2.427	3677	2.511	3817	2.596	3956
10	1.762	3188	1.702	2993	1.757	3173	1.800	3307	1.862	3499	1.926	3690	1.975	3830	2.026	3974
15	1.450	3195	1.418	3000	1.449	3184	1.471	3319	1.505	3512	1.539	3702	1.564	3843	1.591	3989
20	1.201	3203	1.188	3011	1.200	3194	1.210	3329	1.223	3519	1.237	3715	1.247	3856	1.258	4012
25	1.000*1	3207	1.000	3017	1.000*2	3202	1.000	3339	1.000	3532	1.000	3727	1.000	3868	1.000	4024
30	0.837	3211	0.846	3023	0.837	3211	0.831	3350	0.822	3546	0.813	3738	0.807	3881	0.800	4036
35	0.704	3218	0.719	3031	0.704	3223	0.694	3361	0.679	3557	0.665	3748	0.654	3895	0.644	4049
40	0.596	3224	0.613	3046	0.595	3232	0.582	3372	0.564	3568	0.546	3762	0.534	3907	0.521	4062
45	0.506	3227	0.526	3047	0.505	3240	0.490	3383	0.470	3579	0.451	3772	0.438	3919	0.424	4074
50	0.432	3232	0.452	3060	0.430	3248	0.415	3392	0.394	3590	0.375	3782	0.361	3931	0.347	4085
55	0.371	3235	0.391	3062	0.369	3255	0.352	3402	0.332	3599	0.313	3793	0.299	3940	0.285	4096
60	0.320	3237	0.339	3070	0.316	3266	0.301	3411	0.280	3609	0.262	3803	0.249	3951	0.235	4106
65	0.276	3241	0.295	3077	0.273	3271	0.257	3420	0.238	3618	0.220	3813	0.208	3963	0.195	4115
70	0.240	3243	0.258	3080	0.236	3279	0.221	3427	0.203	3626	0.186	3823	0.174	3973	0.163	4126
75	0.209	3246	0.226	3087	0.205	3285	0.191	3436	0.174	3635	0.158	3832	0.147	3982	0.137	4134
80	0.183	3248	0.199	3091	0.179	3292	0.166	3443	0.149	3642	0.134	3841	0.124	3991	0.115	4142
85	0.161*1	3250	0.175	3102	0.156*2	3302	0.144	3451	0.129	3650	0.115	3850	0.106	4000	0.0971	4150
90	0.142	3252	0.155	3105	0.137	3308	0.126	3457	0.111	3657	0.0986	3858	0.0901	4008	0.0824	4158
95	0.126	3253	0.138	3106	0.121	3313	0.110	3461	0.0967	3663	0.0850	3866	0.0772	4016	0.0702	4165
100	0.111	3255	0.123	3109	0.107	3318	0.0966	3467	0.0842	3671	0.0734	3874	0.0664	4023	0.0601	4172
105	0.0992	3256	0.110	3111	0.0945	3324	0.0851	3472	0.0737	3675	0.0637	3881	0.0573	4030	0.0515	4179
110	0.0886	3257	0.0980	3122	0.0841	3327	0.0751	3479	0.0646	3682	0.0554	3888	0.0496	4036	0.0444	4186
115	0.0793	3258	0.0880	3125	0.0750	3331	0.0666	3484	0.0569	3686	0.0484	3895	0.0431	4042	0.0384	4193
120	0.0713	3259	0.0790	3132	0.0668	3339	0.0594	3485	0.0502	3691	0.0424	3901	0.0376	4047	0.0333	4199
125	0.0642	3260	0.0720	3123	0.0600	3340	0.0530	3487	0.0445	3695	0.0372	3906	0.0329	4053	0.0289	4206

Examples

*1 $R_{25} = R_{25}/R_{25}(1.000) \times 470 = 470\Omega$ *2 $R_{25} = R_{25}/R_{25}(1.000) \times 3.3 = 3.3k\Omega$
 $R_{85} = R_{85}/R_{25}(0.161) \times R_{25}(470\Omega) = 75.67\Omega$ $R_{85} = R_{85}/R_{25}(0.156) \times R_{25}(3.3k\Omega) = 0.5148k\Omega$

 Please be sure to request delivery specifications that provide further details on the features and specifications of the products for proper and safe use. Please note that the contents may change without any prior notice due to reasons such as upgrading.

NTCG series **NTCG20 Type**

■ CHARACTERISTICS OF NTC THERMISTORS (EXAMPLE)

Y-axis: Linear



Y-axis: Log.

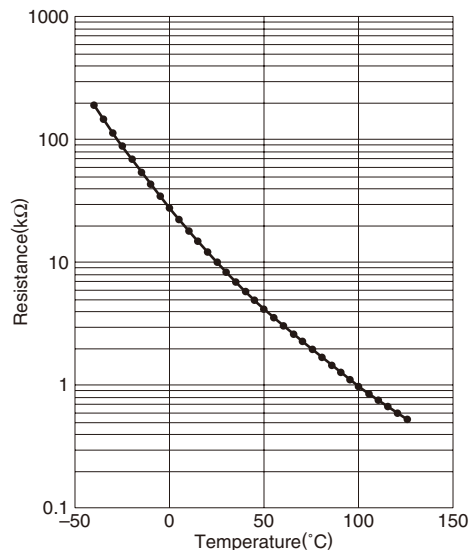

Please be sure to request delivery specifications that provide further details on the features and specifications of the products for proper and safe use. Please note that the contents may change without any prior notice due to reasons such as upgrading.

NTCG series

Packaging Style

REEL DIMENSIONS

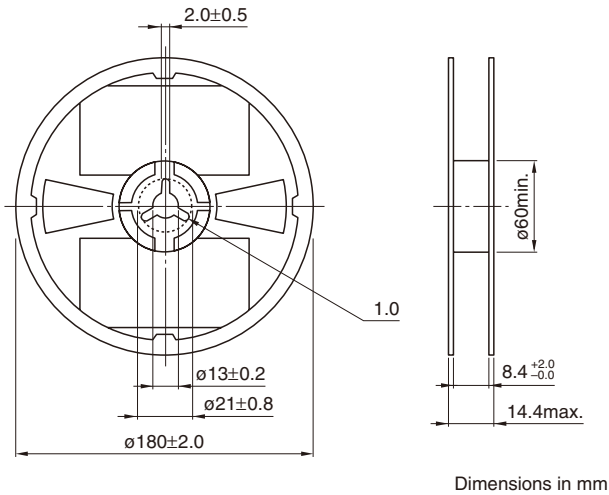

TAPE DIMENSIONS

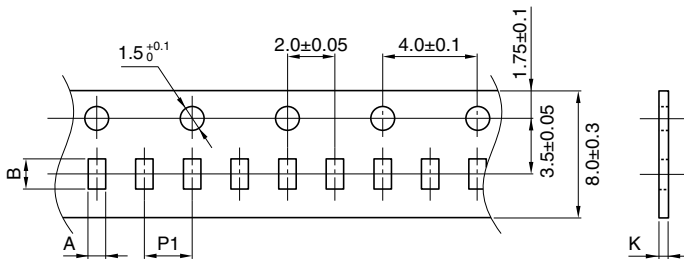

Type	A	B	P1	K
NTCG06	0.38±0.05	0.68±0.05	2±0.05	0.45max.
NTCG10	0.65+0.05/-0.1	1.15+0.05/-0.1	2±0.05	0.7max.
NTCG16	1.1±0.2	1.9±0.2	4±0.1	1.1max.
NTCG20	1.5±0.2	2.3±0.2	4±0.1	1.1max.

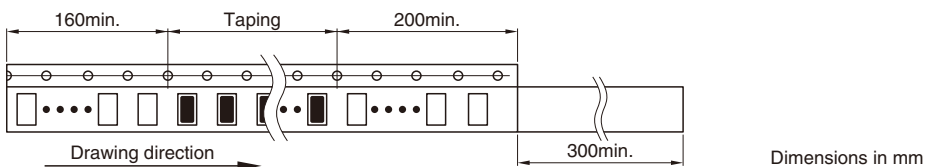

Please be sure to request delivery specifications that provide further details on the features and specifications of the products for proper and safe use. Please note that the contents may change without any prior notice due to reasons such as upgrading.