



# Inductors for Power Circuits

Wound Ferrite

## RLF<sub>series</sub>

---

RLF7030

RLF12545

RLF12560

---

## REMINDERS FOR USING THESE PRODUCTS

Before using these products, be sure to request the delivery specifications.

### SAFETY REMINDERS

Please pay sufficient attention to the warnings for safe designing when using these products.

#### REMINDERS

- The storage period is less than 6 months. Be sure to follow the storage conditions (Temperature: 5 to 30°C, Humidity: 10 to 75% RH or less).  
If the storage period elapses, the soldering of the terminal electrodes may deteriorate.
- Do not use or store in locations where there are conditions such as gas corrosion (salt, acid, alkali, etc.).
- Before soldering, be sure to preheat components.  
The preheating temperature should be set so that the temperature difference between the solder temperature and chip temperature does not exceed 150°C.
- Soldering corrections after mounting should be within the range of the conditions determined in the specifications.  
If overheated, a short circuit, performance deterioration, or lifespan shortening may occur.
- When embedding a printed circuit board where a chip is mounted to a set, be sure that residual stress is not given to the chip due to the overall distortion of the printed circuit board and partial distortion such as at screw tightening portions.
- Self heating (temperature increase) occurs when the power is turned ON, so the tolerance should be sufficient for the set thermal design.
- Carefully lay out the coil for the circuit board design of the non-magnetic shield type.  
A malfunction may occur due to magnetic interference.
- Use a wrist band to discharge static electricity in your body through the grounding wire.
- Do not expose the products to magnets or magnetic fields.
- Do not use for a purpose outside of the contents regulated in the delivery specifications.
- The products listed on this catalog are intended for use in general electronic equipment (AV equipment, telecommunications equipment, home appliances, amusement equipment, computer equipment, personal equipment, office equipment, measurement equipment, industrial robots) under a normal operation and use condition.  
The products are not designed or warranted to meet the requirements of the applications listed below, whose performance and/or quality require a more stringent level of safety or reliability, or whose failure, malfunction or trouble could cause serious damage to society, person or property.  
If you intend to use the products in the applications listed below or if you have special requirements exceeding the range or conditions set forth in the each catalog, please contact us.

- (1) Aerospace/Aviation equipment
- (2) Transportation equipment (cars, electric trains, ships, etc.)
- (3) Medical equipment
- (4) Power-generation control equipment
- (5) Atomic energy-related equipment
- (6) Seabed equipment
- (7) Transportation control equipment

- (8) Public information-processing equipment
- (9) Military equipment
- (10) Electric heating apparatus, burning equipment
- (11) Disaster prevention/crime prevention equipment
- (12) Safety equipment
- (13) Other applications that are not considered general-purpose applications

When designing your equipment even for general-purpose applications, you are kindly requested to take into consideration securing protection circuit/device or providing backup circuits in your equipment.

# Inductors for Power Circuits

Product compatible with RoHS directive

Halogen-free

## Wound Ferrite

Compatible with lead-free solders

# Overview of the RLF Series

## FEATURES

- Magnetic shield type wound inductor for power circuits.
- Using flat-square wire for winding, that is rising space factor, these inductors can reduce DC resistance and suppress calorific value.

## APPLICATION

LCDs, AV equipment, gaming equipment, industrial equipment, other electrical devices

## PART NUMBER CONSTRUCTION

RLF		7030		T		-		1R0		N		6R4		-		PF	
Series name	LxWxH Dimensions (mm)		Packaging style		Inductance (μH)		Inductance tolerance		Rated current (A)		Internal code						
	7030	7.3x6.8x3.2	T	Taping	1R0	1.0	M	±20%	1R0	1.0							
12545	12.5x12.8x4.7			100	10	N	±30%	100	10								
12560	12.5x12.8x6.0																

## OPERATING TEMPERATURE RANGE, PACKAGE QUANTITY, PRODUCT WEIGHT

Type	Temperature range		Package quantity (pieces/reel)	Individual weight (mg)
	Operating temperature* (°C)	Storage temperature** (°C)		
	RLF7030	-40 to +125	-40 to +125	1000
RLF12545	-40 to +105	-40 to +105	500	3200
RLF12560	-40 to +105	-40 to +105	500	4000

\* Operating temperature range includes self-temperature rise.

\*\* The Storage temperature range is for after the circuit board is mounted.

○ RoHS Directive Compliant Product: See the following for more details related to RoHS Directive compliant products. <http://www.tdk.co.jp/rohs/>

○ Halogen-free: Indicates that Cl content is less than 900ppm, Br content is less than 900ppm, and that the total Cl and Br content is less than 1500ppm.

• All specifications are subject to change without notice.

# Overview of the RLF Series

## RECOMMENDED REFLOW PROFILE



Preheating			Soldering		Peak	
Temp.	Temp.	Time	Temp.	Time	Temp.	Time
T1	T2	t1	T3	t2	T4	t3
150°C	180°C	60 to 120s	230°C	30s	250°C	5s

RLF series

# RLF7030 Type



## SHAPE & DIMENSIONS

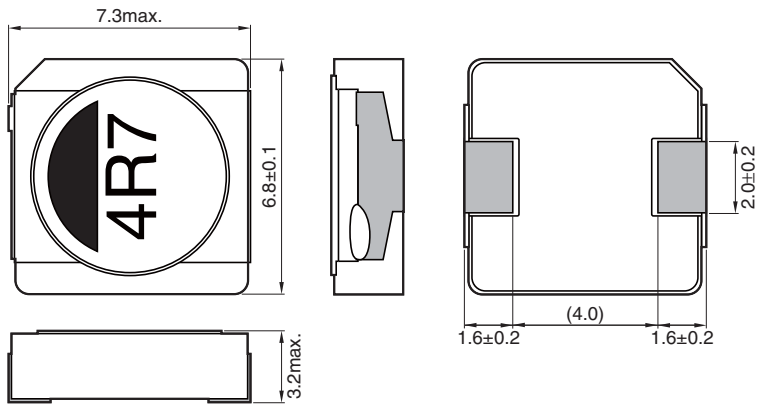

Dimensions in mm

## RECOMMENDED LAND PATTERN

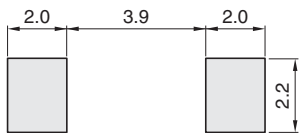

Dimensions in mm

# RLF series RLF7030 Type

## ■ ELECTRICAL CHARACTERISTICS

### □ CHARACTERISTICS SPECIFICATION TABLE

L ( $\mu$ H)	Tolerance	L measuring frequency (kHz)	DC resistance ( $m\Omega$ ) $\pm$ 20% typ.	Rated current(A)*		Part No.
				max. Idc1	Idc2	
1	$\pm$ 30%	100	7.3	7.9	6.4	RLF7030T-1R0N6R4
1.5	$\pm$ 30%	100	8.0	6.5	6.1	RLF7030T-1R5N6R1
2.2	$\pm$ 20%	100	10	5.5	5.4	RLF7030T-2R2M5R4
3.3	$\pm$ 20%	100	17.4	4.4	4.1	RLF7030T-3R3M4R1
4.7	$\pm$ 20%	100	26	3.5	3.4	RLF7030T-4R7M3R4
6.8	$\pm$ 20%	100	37.3	3.0	2.8	RLF7030T-6R8M2R8

\* Rated current: smaller value of either Idc1 or Idc2.

Idc1: When based on the inductance change rate (30% below the nominal value)

Idc2: When based on the temperature increase (Temperature increase of 40°C by self heating)

### ○ Measurement equipment

Measurement item	Product No.	Manufacturer
L	4194A	Agilent Technologies
DC resistance	VP-2941A	Panasonic
Rated current Idc1	4285A+42841A+42842C	Agilent Technologies

\* Equivalent measurement equipment may be used.

# RLF series RLF7030 Type

## ELECTRICAL CHARACTERISTICS

### L FREQUENCY CHARACTERISTICS GRAPH

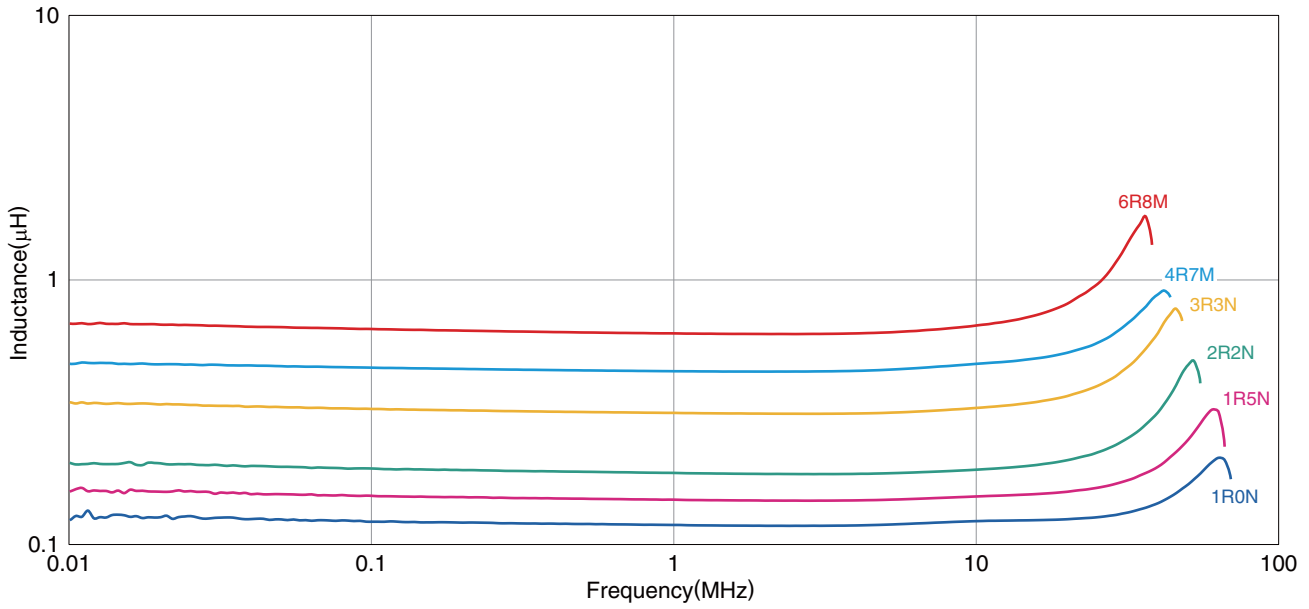

○ Measurement equipment

Product No.	Manufacturer
4294A	Agilent Technologies

\* Equivalent measurement equipment may be used.

# RLF series **RLF7030 Type**

## ■ ELECTRICAL CHARACTERISTICS

### □ INDUCTANCE VS. DC BIAS CHARACTERISTICS GRAPH

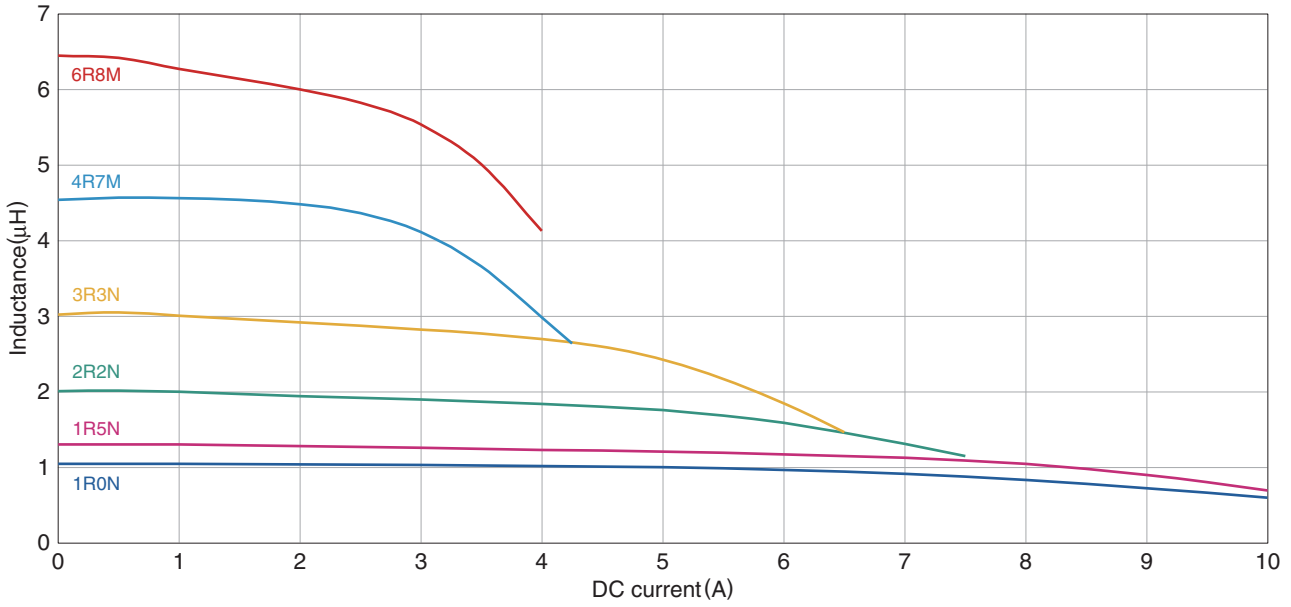

○ Measurement equipment

Product No.	Manufacturer
4285A+42841A+42842C	Agilent Technologies

\* Equivalent measurement equipment may be used.

• All specifications are subject to change without notice.



RLF series

# RLF12545 Type



## SHAPE & DIMENSIONS

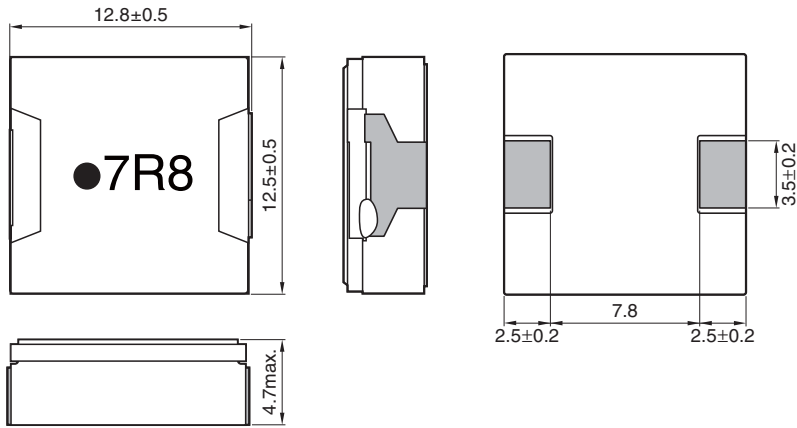

Dimensions in mm

## RECOMMENDED LAND PATTERN

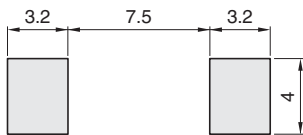

Dimensions in mm

# RLF series RLF12545 Type

## ■ ELECTRICAL CHARACTERISTICS

### □ CHARACTERISTICS SPECIFICATION TABLE

L ( $\mu$ H)	Tolerance	L measuring frequency (kHz)	DC resistance (m $\Omega$ ) $\pm$ 20%	Rated current(A)*		Part No.
				max. Idc1	Idc2	
1.9	$\pm$ 30%	100	3.6	13	10.5	RLF12545T-1R9N100-PF
2.7	$\pm$ 30%	100	4.5	12	8.7	RLF12545T-2R7N8R7-PF
4.2	$\pm$ 30%	100	7.4	9.5	6.5	RLF12545T-4R2N6R5-PF
5.6	$\pm$ 30%	100	8.5	8	6.1	RLF12545T-5R6N6R1-PF
7.8	$\pm$ 30%	100	10.2	7	5.4	RLF12545T-7R8N5R4-PF
10	$\pm$ 20%	100	12.4	6	5.1	RLF12545T-100M5R1-PF

\* Rated current: smaller value of either Idc1 or Idc2.

Idc1: When based on the inductance change rate (50% below the nominal value)

Idc2: When based on the temperature increase (Temperature increase of 40°C by self heating)

### ○ Measurement equipment

Measurement item	Product No.	Manufacturer
L	4263B	Agilent Technologies
DC resistance	VP-2941A	Panasonic
Rated current Idc1	4285A+42841A+42842C	Agilent Technologies

\* Equivalent measurement equipment may be used.

# RLF series RLF12545 Type

## ELECTRICAL CHARACTERISTICS

### L FREQUENCY CHARACTERISTICS GRAPH

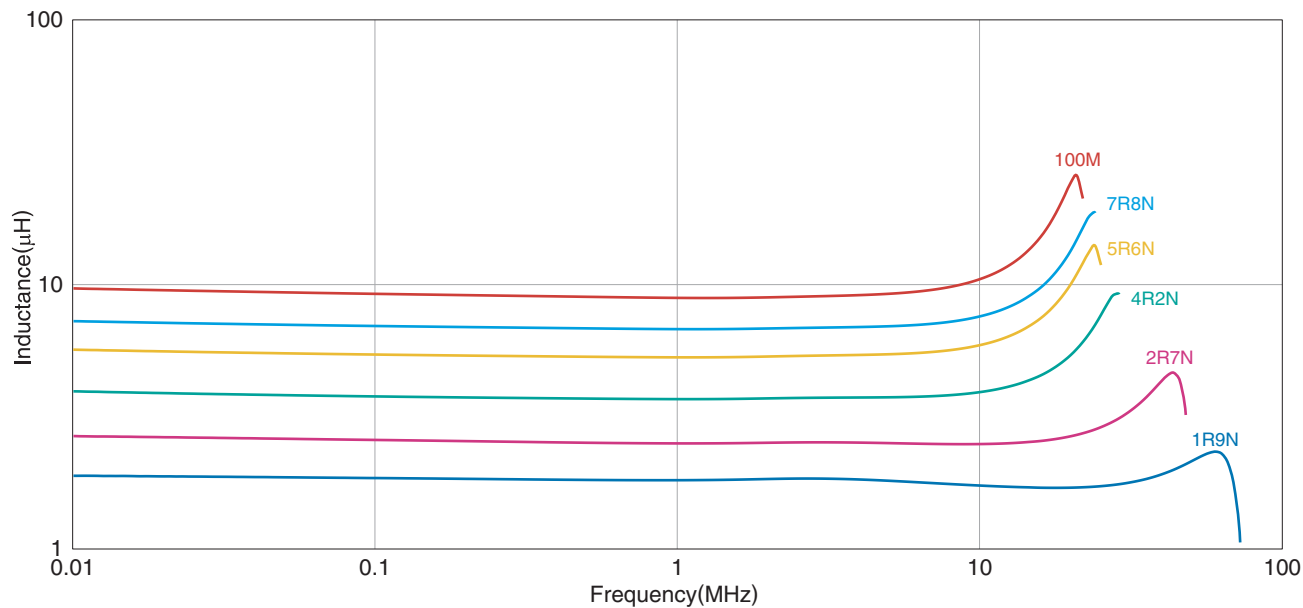

○ Measurement equipment

Product No.	Manufacturer
4294A	Agilent Technologies

\* Equivalent measurement equipment may be used.

• All specifications are subject to change without notice.

# RLF series RLF12545 Type

## ELECTRICAL CHARACTERISTICS

### INDUCTANCE VS. DC BIAS CHARACTERISTICS GRAPH

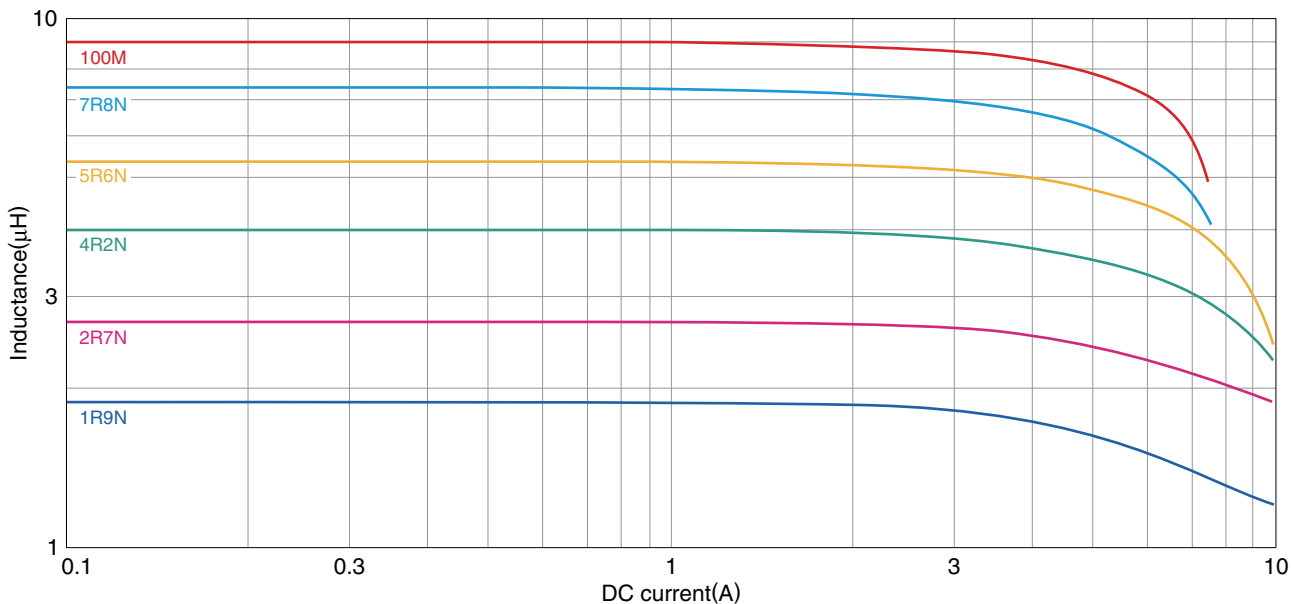

○ Measurement equipment

Product No.	Manufacturer
4285A+42841A+42842C	Agilent Technologies

\* Equivalent measurement equipment may be used.

• All specifications are subject to change without notice.

RLF series

# RLF12560 Type



## SHAPE & DIMENSIONS

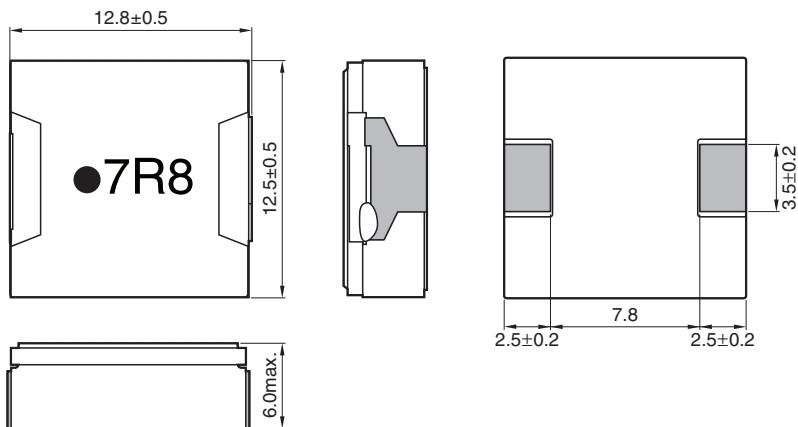

Dimensions in mm

## RECOMMENDED LAND PATTERN

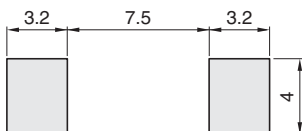

Dimensions in mm

• All specifications are subject to change without notice.

# RLF series RLF12560 Type

## ELECTRICAL CHARACTERISTICS

### CHARACTERISTICS SPECIFICATION TABLE

L ( $\mu$ H)	Tolerance	L measuring frequency (kHz)	DC resistance ( $m\Omega$ ) $\pm$ 20%	Rated current(A)*		Part No.
				max. Idc1	Idc2	
1.0	$\pm$ 30%	100	2.8	18.5	14.4	RLF12560T-1R0N140
1.9	$\pm$ 30%	100	3.6	15.6	12.7	RLF12560T-1R9N120
2.7	$\pm$ 30%	100	4.5	14.4	11.5	RLF12560T-2R7N110
4.2	$\pm$ 30%	100	7.4	10.2	10.0	RLF12560T-4R2N100
5.6	$\pm$ 30%	100	8.5	9.7	9.2	RLF12560T-5R6N9R2
7.8	$\pm$ 30%	100	10.2	8.2	8.4	RLF12560T-7R8N8R2
10	$\pm$ 20%	100	12.4	7.5	7.8	RLF12560T-100M7R5

\* Rated current: smaller value of either Idc1 or Idc2.

Idc1: When based on the inductance change rate (50% below the nominal value)

Idc2: When based on the temperature increase (Temperature increase of 40°C by self heating)

### Measurement equipment

Measurement item	Product No.	Manufacturer
L	4263B	Agilent Technologies
DC resistance	VP-2941A	Panasonic
Rated current Idc1	4285A+42841A+42842C	Agilent Technologies

\* Equivalent measurement equipment may be used.

# RLF series RLF12560 Type

## ELECTRICAL CHARACTERISTICS

### L FREQUENCY CHARACTERISTICS GRAPH

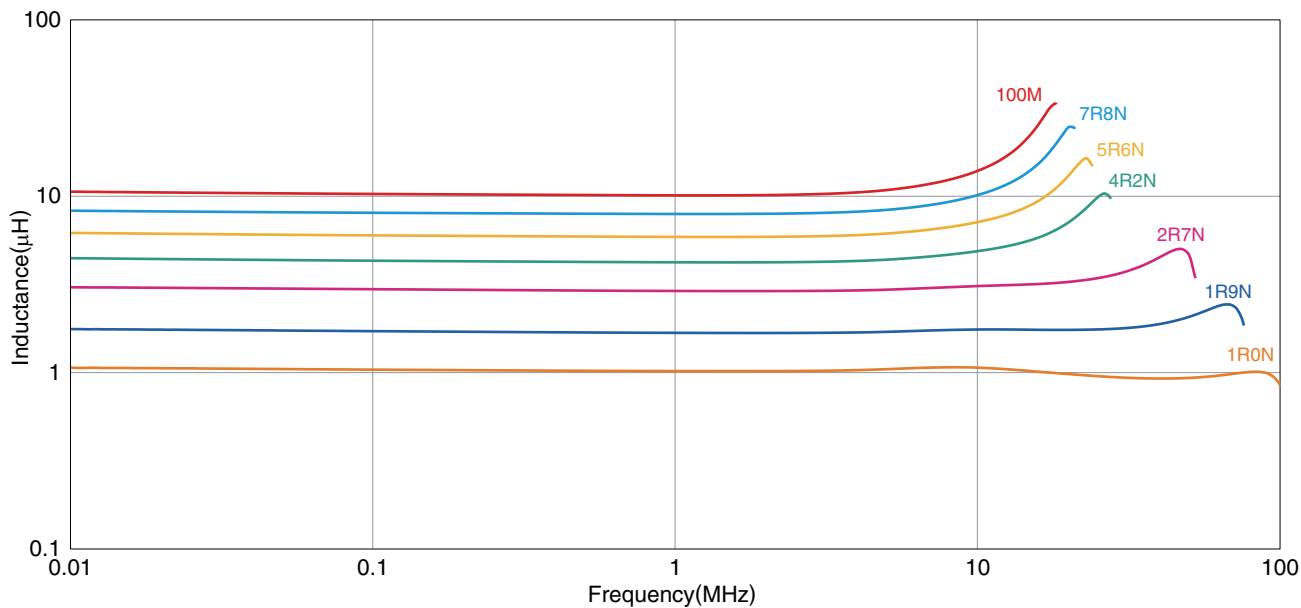

○ Measurement equipment

Product No.	Manufacturer
4294A	Agilent Technologies

\* Equivalent measurement equipment may be used.

# RLF series RLF12560 Type

## ELECTRICAL CHARACTERISTICS

### INDUCTANCE VS. DC BIAS CHARACTERISTICS GRAPH

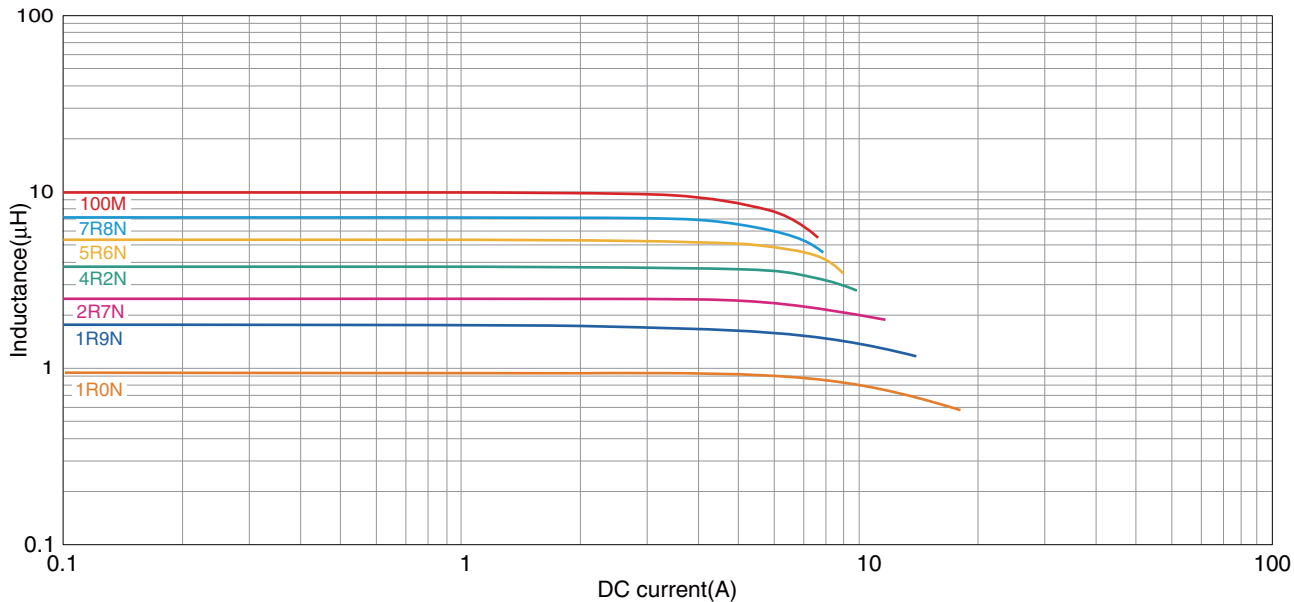

○ Measurement equipment

Product No.	Manufacturer
4285A+42841A+42842C	Agilent Technologies

\* Equivalent measurement equipment may be used.

• All specifications are subject to change without notice.



RLF series

# Packaging Style

## REEL DIMENSIONS

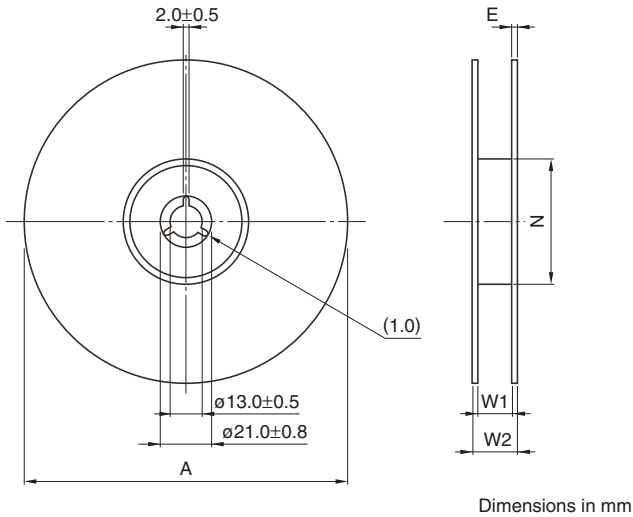

Type	A	W1	W2	N	E
RLF7030	$\phi 330$	16.4	22.4	$\phi 50$	2
RLF12545	$\phi 330$	24.4	30.4	$\phi 50$	2
RLF12560	$\phi 330$	24.4	30.4	$\phi 50$	2

\* These values are typical values.

## TAPE DIMENSIONS

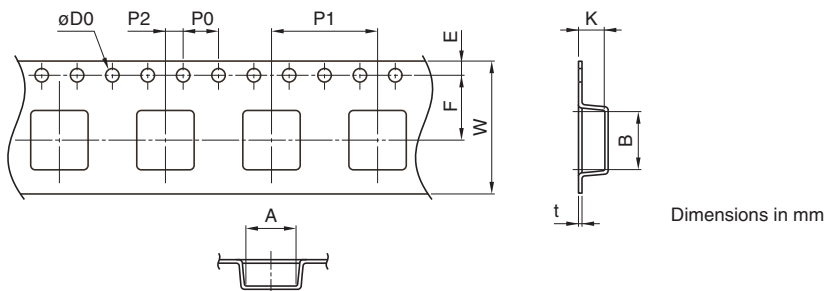

Type	A	B	$\phi D0$	E	F	P0	P1	P2	W	K	t
RLF7030	7.4	7.6	$1.5 \pm 0.10 / -0$	$1.75 \pm 0.1$	$7.5 \pm 0.1$	$4.0 \pm 0.1$	$10.0 \pm 0.1$	$2.0 \pm 0.1$	$16.0 \pm 0.3$	3.6	0.4
RLF12545	13.2	13.5	1.5	$1.75 \pm 0.1$	$11.5 \pm 0.1$	$4.0 \pm 0.1$	$16.0 \pm 0.1$	$2.0 \pm 0.1$	$24.0 \pm 0.3$	4.9	0.4
RLF12560	13.2	13.5	1.5	$1.75 \pm 0.1$	$11.5 \pm 0.1$	$4.0 \pm 0.1$	$16.0 \pm 0.1$	$2.0 \pm 0.1$	$24.0 \pm 0.3$	6.2	0.5

• All specifications are subject to change without notice.