



# Inductors for High Frequency

Multilayer Ceramic

## MLG series

---

|                 |                          |
|-----------------|--------------------------|
| <b>MLG0603S</b> | <b>0603 [0201 inch]*</b> |
| <b>MLG1005S</b> | <b>1005 [0402 inch]</b>  |
| <b>MLG1608</b>  | <b>1608 [0603 inch]</b>  |

\* Dimensions Code JIS[EIA]

---

## REMINDERS FOR USING THESE PRODUCTS

Before using these products, be sure to request the delivery specifications.

### SAFETY REMINDERS

Please pay sufficient attention to the warnings for safe designing when using these products.

#### REMINDERS

- The storage period is less than 12 months. Be sure to follow the storage conditions (Temperature: 5 to 40°C, Humidity: 10 to 75% RH or less).  
If the storage period elapses, the soldering of the terminal electrodes may deteriorate.
- Do not use or store in locations where there are conditions such as gas corrosion (salt, acid, alkali, etc.).
- Before soldering, be sure to preheat components.  
The preheating temperature should be set so that the temperature difference between the solder temperature and chip temperature does not exceed 150°C.
- Soldering corrections after mounting should be within the range of the conditions determined in the specifications.  
If overheated, a short circuit, performance deterioration, or lifespan shortening may occur.
- When embedding a printed circuit board where a chip is mounted to a set, be sure that residual stress is not given to the chip due to the overall distortion of the printed circuit board and partial distortion such as at screw tightening portions.
- Self heating (temperature increase) occurs when the power is turned ON, so the tolerance should be sufficient for the set thermal design.
- Carefully lay out the coil for the circuit board design of the non-magnetic shield type.  
A malfunction may occur due to magnetic interference.
- Use a wrist band to discharge static electricity in your body through the grounding wire.
- Do not expose the products to magnets or magnetic fields.
- Do not use for a purpose outside of the contents regulated in the delivery specifications.
- The products listed on this catalog are intended for use in general electronic equipment (AV equipment, telecommunications equipment, home appliances, amusement equipment, computer equipment, personal equipment, office equipment, measurement equipment, industrial robots) under a normal operation and use condition.  
The products are not designed or warranted to meet the requirements of the applications listed below, whose performance and/or quality require a more stringent level of safety or reliability, or whose failure, malfunction or trouble could cause serious damage to society, person or property.  
If you intend to use the products in the applications listed below or if you have special requirements exceeding the range or conditions set forth in the each catalog, please contact us.

- (1) Aerospace/Aviation equipment
- (2) Transportation equipment (cars, electric trains, ships, etc.)
- (3) Medical equipment
- (4) Power-generation control equipment
- (5) Atomic energy-related equipment
- (6) Seabed equipment
- (7) Transportation control equipment

- (8) Public information-processing equipment
- (9) Military equipment
- (10) Electric heating apparatus, burning equipment
- (11) Disaster prevention/crime prevention equipment
- (12) Safety equipment
- (13) Other applications that are not considered general-purpose applications

When designing your equipment even for general-purpose applications, you are kindly requested to take into consideration securing protection circuit/device or providing backup circuits in your equipment.

# Inductors for High Frequency Circuits

## Multilayer Ceramic

Product compatible with RoHS directive  
Halogen-free  
Compatible with lead-free solders  
AEC-Q200

# Overview of the MLG Series

## FEATURES

- Advanced monolithic structure is formed using a multilayering and sintering process with ceramic and conductive materials for High-frequency.

## APPLICATION

Smart phones, tablet terminals, high frequency modules (PAs, VCOs, FEMs, etc.), Bluetooth, W-LAN, UWB, tuners, automotive equipment and other high frequency circuits for the mobile communication industry

## PART NUMBER CONSTRUCTION

| MLG                | 0603                         | S           | 0N3                          | S | T                      |      |                             |        |                        |        |                      |  |
|--------------------|------------------------------|-------------|------------------------------|---|------------------------|------|-----------------------------|--------|------------------------|--------|----------------------|--|
| <b>Series name</b> | <b>LxWxH Dimensions (mm)</b> |             | <b>Product internal code</b> |   | <b>Inductance (nH)</b> |      | <b>Inductance tolerance</b> |        | <b>Packaging style</b> |        | <b>Internal code</b> |  |
|                    | 0603                         | 0.6x0.3x0.3 | B                            |   | 1N1                    | 1.1  | B                           | ±0.1nH | T                      | Taping |                      |  |
|                    | 1005                         | 1.0x0.5x0.5 | S                            |   | 11N                    | 11   | C                           | ±0.2nH |                        |        |                      |  |
|                    | 1608                         | 1.6x0.8x0.8 |                              |   | R10                    | 100  | S                           | ±0.3nH |                        |        |                      |  |
|                    |                              |             |                              |   | 1R0                    | 1000 | D                           | ±0.5nH |                        |        |                      |  |
|                    |                              |             |                              |   |                        |      | H                           | ±3%    |                        |        |                      |  |
|                    |                              |             |                              |   |                        |      | J                           | ±5%    |                        |        |                      |  |

## OPERATING TEMPERATURE RANGE, PACKAGE QUANTITY, PRODUCT WEIGHT

| Type     | Temperature range             |                              | Package quantity<br>(pieces/reel) | Individual weight<br>(mg) |
|----------|-------------------------------|------------------------------|-----------------------------------|---------------------------|
|          | Operating temperature<br>(°C) | Storage temperature*<br>(°C) |                                   |                           |
|          | MLG0603S                      | -55 to +125                  |                                   |                           |
| MLG1005S | -55 to +125                   | -55 to +125                  | 10000                             | 1                         |
| MLG1608  | -55 to +125                   | -55 to +125                  | 4000                              | 4                         |

\* The Storage temperature range is for after the circuit board is mounted.

- RoHS Directive Compliant Product: See the following for more details related to RoHS Directive compliant products. <http://www.tdk.co.jp/rohs/>
- Halogen-free: Indicates that Cl content is less than 900ppm, Br content is less than 900ppm, and that the total Cl and Br content is less than 1500ppm.

• All specifications are subject to change without notice.

# Overview of the MLG Series

## RECOMMENDED REFLOW PROFILE

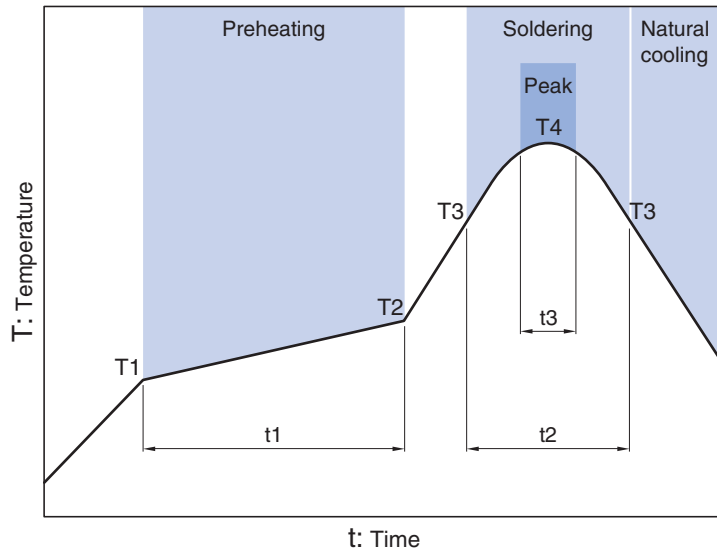

| Preheating |       |            | Soldering |           | Peak         |          |
|------------|-------|------------|-----------|-----------|--------------|----------|
| Temp.      | Temp. | Time       | Temp.     | Time      | Temp.        | Time     |
| T1         | T2    | t1         | T3        | t2        | T4           | t3       |
| 150°C      | 180°C | 60 to 120s | 230°C     | 30 to 60s | 250 to 260°C | 10s max. |

MLGseries

# MLG0603S Type



## ■ SHAPE & DIMENSIONS

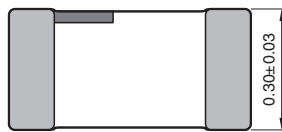
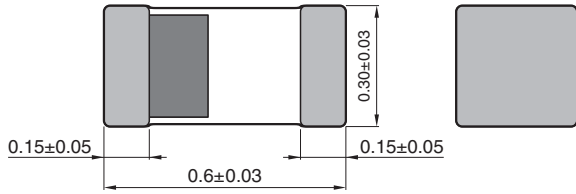

Dimensions in mm

## ■ RECOMMENDED LAND PATTERN

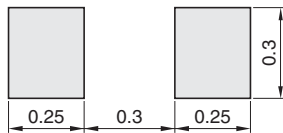

Dimensions in mm

• All specifications are subject to change without notice.

MLGseries **MLG0603S Type**

## ■ ELECTRICAL CHARACTERISTICS

## □ CHARACTERISTICS SPECIFICATION TABLE

| L<br>(nH) | Tolerance                        | Q<br>min. | L, Q measuring<br>frequency<br>(MHz) | Self-resonant<br>frequency<br>(GHz) |       | DC resistance<br>( $\Omega$ ) |      | Rated current<br>(mA)<br>max. | Part No.*                 |
|-----------|----------------------------------|-----------|--------------------------------------|-------------------------------------|-------|-------------------------------|------|-------------------------------|---------------------------|
|           |                                  |           |                                      | min.                                | typ.  | max.                          | typ. |                               |                           |
| 0.3       | $\pm 0.1, \pm 0.2\text{nH}$      | —         | 100                                  | 10.0                                | 20 up | 0.1                           | 0.02 | 600                           | MLG0603S0N3 $\Delta$ T□□□ |
| 0.4       | $\pm 0.1, \pm 0.2\text{nH}$      | —         | 100                                  | 10.0                                | 20 up | 0.1                           | 0.02 | 600                           | MLG0603S0N4 $\Delta$ T□□□ |
| 0.5       | $\pm 0.1, \pm 0.2\text{nH}$      | —         | 100                                  | 10.0                                | 20 up | 0.1                           | 0.02 | 600                           | MLG0603S0N5 $\Delta$ T□□□ |
| 0.6       | $\pm 0.1, \pm 0.2\text{nH}$      | —         | 100                                  | 10.0                                | 20 up | 0.1                           | 0.02 | 600                           | MLG0603S0N6 $\Delta$ T□□□ |
| 0.7       | $\pm 0.1, \pm 0.2\text{nH}$      | —         | 100                                  | 10.0                                | 16.3  | 0.1                           | 0.02 | 600                           | MLG0603S0N7 $\Delta$ T□□□ |
| 0.8       | $\pm 0.1, \pm 0.2\text{nH}$      | —         | 100                                  | 10.0                                | 16.1  | 0.1                           | 0.03 | 600                           | MLG0603S0N8 $\Delta$ T□□□ |
| 0.9       | $\pm 0.1, \pm 0.2\text{nH}$      | —         | 100                                  | 10.0                                | 13.8  | 0.1                           | 0.03 | 600                           | MLG0603S0N9 $\Delta$ T□□□ |
| 1.0       | $\pm 0.1, \pm 0.2, 0.3\text{nH}$ | 4         | 100                                  | 10.0                                | 14.4  | 0.1                           | 0.04 | 600                           | MLG0603S1N0 $\Delta$ T□□□ |
| 1.1       | $\pm 0.1, \pm 0.2, 0.3\text{nH}$ | 4         | 100                                  | 10.0                                | 13.6  | 0.15                          | 0.04 | 550                           | MLG0603S1N1 $\Delta$ T□□□ |
| 1.2       | $\pm 0.1, \pm 0.2, 0.3\text{nH}$ | 4         | 100                                  | 10.0                                | 12.3  | 0.15                          | 0.06 | 550                           | MLG0603S1N2 $\Delta$ T□□□ |
| 1.3       | $\pm 0.1, \pm 0.2, 0.3\text{nH}$ | 4         | 100                                  | 9.0                                 | 11.4  | 0.15                          | 0.07 | 550                           | MLG0603S1N3 $\Delta$ T□□□ |
| 1.5       | $\pm 0.1, \pm 0.2, 0.3\text{nH}$ | 4         | 100                                  | 9.0                                 | 10.4  | 0.15                          | 0.07 | 550                           | MLG0603S1N5 $\Delta$ T□□□ |
| 1.6       | $\pm 0.1, \pm 0.2, 0.3\text{nH}$ | 4         | 100                                  | 9.0                                 | 11.5  | 0.2                           | 0.09 | 500                           | MLG0603S1N6 $\Delta$ T□□□ |
| 1.8       | $\pm 0.1, \pm 0.2, 0.3\text{nH}$ | 4         | 100                                  | 8.5                                 | 10.0  | 0.2                           | 0.12 | 500                           | MLG0603S1N8 $\Delta$ T□□□ |
| 2.0       | $\pm 0.1, \pm 0.2, 0.3\text{nH}$ | 4         | 100                                  | 8.2                                 | 9.8   | 0.25                          | 0.14 | 400                           | MLG0603S2N0 $\Delta$ T□□□ |
| 2.2       | $\pm 0.1, \pm 0.2, 0.3\text{nH}$ | 4         | 100                                  | 8.0                                 | 8.9   | 0.25                          | 0.14 | 400                           | MLG0603S2N2 $\Delta$ T□□□ |
| 2.4       | $\pm 0.1, \pm 0.2, 0.3\text{nH}$ | 4         | 100                                  | 8.0                                 | 9.2   | 0.25                          | 0.15 | 300                           | MLG0603S2N4 $\Delta$ T□□□ |
| 2.7       | $\pm 0.1, \pm 0.2, 0.3\text{nH}$ | 4         | 100                                  | 6.5                                 | 8.1   | 0.25                          | 0.15 | 300                           | MLG0603S2N7 $\Delta$ T□□□ |
| 3.0       | $\pm 0.1, \pm 0.2, 0.3\text{nH}$ | 4         | 100                                  | 6.2                                 | 7.8   | 0.3                           | 0.20 | 300                           | MLG0603S3N0 $\Delta$ T□□□ |
| 3.3       | $\pm 0.1, \pm 0.2, 0.3\text{nH}$ | 4         | 100                                  | 5.8                                 | 7.0   | 0.35                          | 0.23 | 300                           | MLG0603S3N3 $\Delta$ T□□□ |
| 3.6       | $\pm 0.1, \pm 0.2, 0.3\text{nH}$ | 4         | 100                                  | 5.5                                 | 6.9   | 0.35                          | 0.22 | 300                           | MLG0603S3N6 $\Delta$ T□□□ |
| 3.9       | $\pm 0.1, \pm 0.2, 0.3\text{nH}$ | 5         | 100                                  | 5.0                                 | 6.6   | 0.4                           | 0.27 | 300                           | MLG0603S3N9 $\Delta$ T□□□ |
| 4.3       | $\pm 3\%, \pm 0.3\text{nH}$      | 5         | 100                                  | 5.0                                 | 6.4   | 0.4                           | 0.27 | 300                           | MLG0603S4N3 $\Delta$ T□□□ |
| 4.7       | $\pm 3\%, \pm 0.3\text{nH}$      | 5         | 100                                  | 4.5                                 | 5.4   | 0.45                          | 0.28 | 300                           | MLG0603S4N7 $\Delta$ T□□□ |
| 5.1       | $\pm 3\%, \pm 0.3\text{nH}$      | 5         | 100                                  | 4.5                                 | 5.5   | 0.45                          | 0.23 | 250                           | MLG0603S5N1 $\Delta$ T□□□ |
| 5.6       | $\pm 3\%, \pm 0.3\text{nH}$      | 5         | 100                                  | 4.2                                 | 5.3   | 0.5                           | 0.31 | 250                           | MLG0603S5N6 $\Delta$ T□□□ |
| 6.2       | $\pm 3\%, \pm 0.3\text{nH}$      | 5         | 100                                  | 4.2                                 | 5.1   | 0.55                          | 0.32 | 250                           | MLG0603S6N2 $\Delta$ T□□□ |
| 6.8       | $\pm 3, \pm 5\%$                 | 5         | 100                                  | 3.6                                 | 4.4   | 0.6                           | 0.32 | 250                           | MLG0603S6N8 $\Delta$ T□□□ |
| 7.5       | $\pm 3, \pm 5\%$                 | 5         | 100                                  | 4.2                                 | 5.3   | 0.7                           | 0.43 | 200                           | MLG0603S7N5 $\Delta$ T□□□ |
| 8.2       | $\pm 3, \pm 5\%$                 | 5         | 100                                  | 3.8                                 | 4.5   | 0.7                           | 0.45 | 200                           | MLG0603S8N2 $\Delta$ T□□□ |
| 9.1       | $\pm 3, \pm 5\%$                 | 5         | 100                                  | 3.4                                 | 4.9   | 0.8                           | 0.51 | 200                           | MLG0603S9N1 $\Delta$ T□□□ |
| 10        | $\pm 3, \pm 5\%$                 | 5         | 100                                  | 3.2                                 | 4.1   | 0.8                           | 0.53 | 200                           | MLG0603S10N $\Delta$ T□□□ |
| 11        | $\pm 3, \pm 5\%$                 | 6         | 100                                  | 3.0                                 | 3.7   | 0.8                           | 0.53 | 200                           | MLG0603S11N $\Delta$ T□□□ |
| 12        | $\pm 3, \pm 5\%$                 | 6         | 100                                  | 2.8                                 | 3.6   | 0.9                           | 0.63 | 180                           | MLG0603S12N $\Delta$ T□□□ |
| 13        | $\pm 3, \pm 5\%$                 | 6         | 100                                  | 2.7                                 | 3.4   | 0.9                           | 0.60 | 180                           | MLG0603S13N $\Delta$ T□□□ |
| 15        | $\pm 3, \pm 5\%$                 | 6         | 100                                  | 2.5                                 | 3.3   | 1.1                           | 0.69 | 180                           | MLG0603S15N $\Delta$ T□□□ |
| 16        | $\pm 3, \pm 5\%$                 | 6         | 100                                  | 2.3                                 | 3.0   | 1.1                           | 0.70 | 180                           | MLG0603S16N $\Delta$ T□□□ |
| 18        | $\pm 3, \pm 5\%$                 | 6         | 100                                  | 2.2                                 | 2.8   | 1.2                           | 0.78 | 150                           | MLG0603S18N $\Delta$ T□□□ |
| 20        | $\pm 3, \pm 5\%$                 | 6         | 100                                  | 2.1                                 | 2.6   | 1.2                           | 0.75 | 150                           | MLG0603S20N $\Delta$ T□□□ |
| 22        | $\pm 3, \pm 5\%$                 | 6         | 100                                  | 2.0                                 | 2.5   | 1.2                           | 0.88 | 150                           | MLG0603S22N $\Delta$ T□□□ |
| 24        | $\pm 3, \pm 5\%$                 | 6         | 100                                  | 1.9                                 | 2.3   | 1.3                           | 0.90 | 150                           | MLG0603S24N $\Delta$ T□□□ |
| 27        | $\pm 3, \pm 5\%$                 | 6         | 100                                  | 1.8                                 | 2.2   | 1.5                           | 1.00 | 100                           | MLG0603S27N $\Delta$ T□□□ |
| 30        | $\pm 3, \pm 5\%$                 | 6         | 100                                  | 1.6                                 | 2.0   | 1.6                           | 0.95 | 100                           | MLG0603S30N $\Delta$ T□□□ |
| 33        | $\pm 3, \pm 5\%$                 | 6         | 100                                  | 1.6                                 | 2.0   | 1.8                           | 1.20 | 100                           | MLG0603S33N $\Delta$ T□□□ |

\* The " $\Delta$ " of the Part Number contains the inductance tolerance code, B( $\pm 0.1\text{nH}$ ), C( $\pm 0.2\text{nH}$ ), S( $\pm 0.3\text{nH}$ ), H( $\pm 3\%$ ) or J( $\pm 5\%$ ).  
Please contact us for information on inductance tolerance, G ( $\pm 2\%$ ).

\* The "□□□" of the Part Number contains the internal code.

## ○ Measurement equipment

| Measurement item        | Product No.  | Manufacturer         |
|-------------------------|--------------|----------------------|
| L, Q                    | 4291B+16197A | Agilent Technologies |
| Self-resonant frequency | 8720C        | Agilent Technologies |
| DC resistance           | Type-7561    | Yokogawa             |

\* Equivalent measurement equipment may be used.

MLG<sub>series</sub> **MLG0603S Type**

## ■ ELECTRICAL CHARACTERISTICS

## □ CHARACTERISTICS SPECIFICATION TABLE

| L<br>(nH) | Tolerance        | Q<br>min. | L, Q measuring<br>frequency<br>(MHz) | Self-resonant<br>frequency<br>(GHz) |      | DC resistance<br>( $\Omega$ ) |      | Rated current<br>(mA)<br>max. | Part No.*                 |
|-----------|------------------|-----------|--------------------------------------|-------------------------------------|------|-------------------------------|------|-------------------------------|---------------------------|
|           |                  |           |                                      | min.                                | typ. | max.                          | typ. |                               |                           |
| 36        | $\pm 3, \pm 5\%$ | 6         | 100                                  | 1.5                                 | 1.8  | 2.0                           | 1.68 | 50                            | MLG0603S36N $\Delta$ T□□□ |
| 39        | $\pm 3, \pm 5\%$ | 6         | 100                                  | 1.4                                 | 1.6  | 2.0                           | 1.40 | 50                            | MLG0603S39N $\Delta$ T□□□ |
| 43        | $\pm 3, \pm 5\%$ | 6         | 100                                  | 1.3                                 | 1.6  | 2.2                           | 1.91 | 50                            | MLG0603S43N $\Delta$ T□□□ |
| 47        | $\pm 3, \pm 5\%$ | 6         | 100                                  | 1.3                                 | 1.5  | 2.2                           | 1.48 | 50                            | MLG0603S47N $\Delta$ T□□□ |
| 51        | $\pm 3, \pm 5\%$ | 5         | 100                                  | 1.2                                 | 1.5  | 2.8                           | 1.98 | 50                            | MLG0603S51N $\Delta$ T□□□ |
| 56        | $\pm 3, \pm 5\%$ | 5         | 100                                  | 1.2                                 | 1.4  | 3.2                           | 2.11 | 50                            | MLG0603S56N $\Delta$ T□□□ |
| 62        | $\pm 3, \pm 5\%$ | 5         | 100                                  | 1.1                                 | 1.3  | 3.3                           | 2.22 | 50                            | MLG0603S62N $\Delta$ T□□□ |
| 68        | $\pm 3, \pm 5\%$ | 5         | 100                                  | 1.05                                | 1.24 | 3.5                           | 2.40 | 50                            | MLG0603S68N $\Delta$ T□□□ |
| 75        | $\pm 3, \pm 5\%$ | 5         | 100                                  | 0.95                                | 1.17 | 3.8                           | 2.67 | 50                            | MLG0603S75N $\Delta$ T□□□ |
| 82        | $\pm 3, \pm 5\%$ | 5         | 100                                  | 0.90                                | 1.08 | 4.0                           | 2.80 | 50                            | MLG0603S82N $\Delta$ T□□□ |
| 91        | $\pm 3, \pm 5\%$ | 5         | 100                                  | 0.77                                | 0.94 | 4.3                           | 2.97 | 50                            | MLG0603S91N $\Delta$ T□□□ |
| 100       | $\pm 3, \pm 5\%$ | 5         | 100                                  | 0.77                                | 0.94 | 4.5                           | 3.13 | 50                            | MLG0603SR10 $\Delta$ T□□□ |
| 110       | $\pm 3, \pm 5\%$ | 5         | 100                                  | 0.77                                | 0.94 | 6.5                           | 5.24 | 50                            | MLG0603SR11 $\Delta$ T□□□ |
| 120       | $\pm 3, \pm 5\%$ | 5         | 100                                  | 0.70                                | 0.88 | 7.0                           | 5.53 | 50                            | MLG0603SR12 $\Delta$ T□□□ |
| 130       | $\pm 3, \pm 5\%$ | 5         | 100                                  | 0.67                                | 0.84 | 7.3                           | 5.68 | 50                            | MLG0603SR13 $\Delta$ T□□□ |
| 150       | $\pm 3, \pm 5\%$ | 5         | 100                                  | 0.64                                | 0.77 | 8.0                           | 6.24 | 50                            | MLG0603SR15 $\Delta$ T□□□ |
| 160       | $\pm 3, \pm 5\%$ | 5         | 100                                  | 0.60                                | 0.73 | 8.3                           | 6.67 | 50                            | MLG0603SR16 $\Delta$ T□□□ |
| 180       | $\pm 3, \pm 5\%$ | 5         | 100                                  | 0.56                                | 0.68 | 8.5                           | 6.99 | 50                            | MLG0603SR18 $\Delta$ T□□□ |

\* The " $\Delta$ " of the Part Number contains the inductance tolerance code, B( $\pm 0.1$ nH), C( $\pm 0.2$ nH), S( $\pm 0.3$ nH), H( $\pm 3\%$ ) or J( $\pm 5\%$ ).  
Please contact us for information on inductance tolerance, G ( $\pm 2\%$ ).

\* The "□□□" of the Part Number contains the internal code.

## ○ Measurement equipment

| Measurement item        | Product No.  | Manufacturer         |
|-------------------------|--------------|----------------------|
| L, Q                    | 4291B+16197A | Agilent Technologies |
| Self-resonant frequency | 8720C        | Agilent Technologies |
| DC resistance           | Type-7561    | Yokogawa             |

\* Equivalent measurement equipment may be used.

MLGseries **MLG0603S Type**

## ■ ELECTRICAL CHARACTERISTICS

## □ L, Q FREQUENCY CHARACTERISTICS TABLE

| L(nH)typ. |        |        |        |        | Q typ. |        |        |        |        | Part No.*        |
|-----------|--------|--------|--------|--------|--------|--------|--------|--------|--------|------------------|
| 500MHz    | 800MHz | 1.8GHz | 2.0GHz | 2.4GHz | 500MHz | 800MHz | 1.8GHz | 2.0GHz | 2.4GHz |                  |
| 0.3       | 0.3    | 0.3    | 0.3    | 0.3    | 14min. | 18min. | 29min. | 32min. | 35min. | MLG0603S0N3△T□□□ |
| 0.4       | 0.4    | 0.4    | 0.4    | 0.4    | 14min. | 18min. | 29min. | 32min. | 35min. | MLG0603S0N4△T□□□ |
| 0.5       | 0.5    | 0.5    | 0.5    | 0.5    | 14     | 18     | 29     | 32     | 35     | MLG0603S0N5△T□□□ |
| 0.6       | 0.6    | 0.5    | 0.5    | 0.5    | 16     | 20     | 33     | 34     | 39     | MLG0603S0N6△T□□□ |
| 0.7       | 0.6    | 0.6    | 0.6    | 0.6    | 16     | 21     | 33     | 35     | 39     | MLG0603S0N7△T□□□ |
| 0.7       | 0.7    | 0.7    | 0.7    | 0.7    | 15     | 20     | 32     | 34     | 38     | MLG0603S0N8△T□□□ |
| 0.8       | 0.8    | 0.8    | 0.8    | 0.8    | 15     | 19     | 30     | 32     | 35     | MLG0603S0N9△T□□□ |
| 0.9       | 0.9    | 0.9    | 0.9    | 0.9    | 14     | 18     | 29     | 30     | 34     | MLG0603S1N0△T□□□ |
| 1.0       | 1.0    | 1.0    | 1.0    | 1.0    | 14     | 19     | 29     | 31     | 34     | MLG0603S1N1△T□□□ |
| 1.1       | 1.1    | 1.1    | 1.1    | 1.1    | 14     | 18     | 29     | 30     | 34     | MLG0603S1N2△T□□□ |
| 1.2       | 1.2    | 1.2    | 1.2    | 1.2    | 14     | 18     | 29     | 30     | 33     | MLG0603S1N3△T□□□ |
| 1.4       | 1.4    | 1.4    | 1.4    | 1.4    | 15     | 19     | 29     | 30     | 34     | MLG0603S1N5△T□□□ |
| 1.5       | 1.5    | 1.5    | 1.5    | 1.5    | 14     | 18     | 29     | 30     | 33     | MLG0603S1N6△T□□□ |
| 1.7       | 1.7    | 1.7    | 1.7    | 1.7    | 15     | 19     | 29     | 30     | 33     | MLG0603S1N8△T□□□ |
| 1.9       | 1.9    | 1.9    | 1.9    | 1.9    | 14     | 18     | 28     | 29     | 32     | MLG0603S2N0△T□□□ |
| 2.1       | 2.0    | 2.1    | 2.1    | 2.1    | 14     | 18     | 27     | 28     | 31     | MLG0603S2N2△T□□□ |
| 2.2       | 2.2    | 2.2    | 2.3    | 2.3    | 14     | 18     | 27     | 29     | 32     | MLG0603S2N4△T□□□ |
| 2.5       | 2.5    | 2.6    | 2.6    | 2.7    | 15     | 19     | 28     | 29     | 31     | MLG0603S2N7△T□□□ |
| 2.8       | 2.8    | 2.9    | 2.9    | 3.0    | 15     | 19     | 29     | 31     | 33     | MLG0603S3N0△T□□□ |
| 3.1       | 3.1    | 3.2    | 3.3    | 3.4    | 15     | 19     | 28     | 29     | 31     | MLG0603S3N3△T□□□ |
| 3.4       | 3.4    | 3.5    | 3.6    | 3.7    | 14     | 18     | 26     | 27     | 29     | MLG0603S3N6△T□□□ |
| 3.7       | 3.7    | 3.8    | 3.9    | 4.1    | 15     | 19     | 29     | 29     | 32     | MLG0603S3N9△T□□□ |
| 4.1       | 4.1    | 4.3    | 4.4    | 4.6    | 14     | 18     | 27     | 27     | 29     | MLG0603S4N3△T□□□ |
| 4.4       | 4.4    | 4.8    | 4.9    | 5.2    | 15     | 20     | 28     | 29     | 30     | MLG0603S4N7△T□□□ |
| 4.8       | 4.8    | 5.1    | 5.3    | 5.6    | 14     | 18     | 25     | 26     | 27     | MLG0603S5N1△T□□□ |
| 5.3       | 5.3    | 5.7    | 5.9    | 6.4    | 16     | 20     | 27     | 28     | 29     | MLG0603S5N6△T□□□ |
| 5.9       | 5.9    | 6.5    | 6.8    | 7.5    | 15     | 18     | 25     | 25     | 26     | MLG0603S6N2△T□□□ |
| 6.4       | 6.5    | 7.4    | 7.8    | 8.7    | 15     | 19     | 26     | 26     | 25     | MLG0603S6N8△T□□□ |
| 7.1       | 7.1    | 7.8    | 8.0    | 8.7    | 14     | 18     | 25     | 26     | 26     | MLG0603S7N5△T□□□ |
| 7.8       | 7.8    | 8.8    | 9.3    | 10.4   | 15     | 18     | 24     | 24     | 24     | MLG0603S8N2△T□□□ |
| 8.6       | 8.6    | 9.8    | 10.3   | 11.5   | 14     | 17     | 22     | 22     | 22     | MLG0603S9N1△T□□□ |
| 10        | 10     | 12     | 12     | 15     | 15     | 18     | 23     | 22     | 21     | MLG0603S10N△T□□□ |
| 10        | 11     | 13     | 14     | 16     | 15     | 18     | 22     | 22     | 20     | MLG0603S11N△T□□□ |
| 11        | 12     | 14     | 15     | 19     | 16     | 19     | 24     | 23     | 20     | MLG0603S12N△T□□□ |
| 12        | 13     | 16     | 17     | 22     | 14     | 16     | 19     | 18     | 15     | MLG0603S13N△T□□□ |
| 14        | 15     | 20     | 23     | 33     | 15     | 19     | 20     | 18     | 14     | MLG0603S15N△T□□□ |
| 15        | 16     | 22     | 25     | 37     | 14     | 16     | 16     | 15     | 11     | MLG0603S16N△T□□□ |
| 17        | 18     | 28     | 35     |        | 14     | 17     | 15     | 13     |        | MLG0603S18N△T□□□ |
| 19        | 20     | 32     |        |        | 13     | 16     | 14     |        |        | MLG0603S20N△T□□□ |
| 21        | 23     | 40     |        |        | 15     | 17     | 13     |        |        | MLG0603S22N△T□□□ |
| 23        | 24     | 45     |        |        | 13     | 15     | 13     |        |        | MLG0603S24N△T□□□ |
| 27        | 29     |        |        |        | 15     | 17     |        |        |        | MLG0603S27N△T□□□ |
| 29        | 32     |        |        |        | 13     | 15     |        |        |        | MLG0603S30N△T□□□ |
| 33        | 36     |        |        |        | 14     | 16     |        |        |        | MLG0603S33N△T□□□ |

\* The "△" of the Part Number contains the inductance tolerance code, B(±0.1nH), C(±0.2nH), S(±0.3nH), H(±3%) or J(±5%).  
Please contact us for information on inductance tolerance, G (±2%).

\* The "□□□" of the Part Number contains the internal code.

○ Measurement equipment

| Product No.  | Manufacturer         |
|--------------|----------------------|
| 4291B+16197A | Agilent Technologies |

\* Equivalent measurement equipment may be used.



MLG<sub>series</sub> **MLG0603S Type**

## ■ ELECTRICAL CHARACTERISTICS

## □ L, Q FREQUENCY CHARACTERISTICS TABLE

| L(nH)typ. |        |        |        |        | Q typ. |        |        |        |        | Part No.*        |
|-----------|--------|--------|--------|--------|--------|--------|--------|--------|--------|------------------|
| 500MHz    | 800MHz | 1.8GHz | 2.0GHz | 2.4GHz | 500MHz | 800MHz | 1.8GHz | 2.0GHz | 2.4GHz |                  |
| 36        | 40     |        |        |        | 14     | 15     |        |        |        | MLG0603S36N△T□□□ |
| 40        | 47     |        |        |        | 13     | 14     |        |        |        | MLG0603S39N△T□□□ |
| 44        | 53     |        |        |        | 14     | 14     |        |        |        | MLG0603S43N△T□□□ |
| 49        | 60     |        |        |        | 13     | 13     |        |        |        | MLG0603S47N△T□□□ |
| 52        | 64     |        |        |        | 11     | 11     |        |        |        | MLG0603S51N△T□□□ |
| 59        | 77     |        |        |        | 12     | 11     |        |        |        | MLG0603S56N△T□□□ |
| 66        | 88     |        |        |        | 11     | 10     |        |        |        | MLG0603S62N△T□□□ |
| 74        | 104    |        |        |        | 13     | 11     |        |        |        | MLG0603S68N△T□□□ |
| 82        | 119    |        |        |        | 10     | 8      |        |        |        | MLG0603S75N△T□□□ |
| 96        | 161    |        |        |        | 12     | 8      |        |        |        | MLG0603S82N△T□□□ |
| 109       |        |        |        |        | 9      |        |        |        |        | MLG0603S91N△T□□□ |
| 129       |        |        |        |        | 11     |        |        |        |        | MLG0603SR10△T□□□ |
| 134       |        |        |        |        | 10     |        |        |        |        | MLG0603SR11△T□□□ |
| 156       |        |        |        |        | 9      |        |        |        |        | MLG0603SR12△T□□□ |
| 172       |        |        |        |        | 8      |        |        |        |        | MLG0603SR13△T□□□ |
| 223       |        |        |        |        | 7      |        |        |        |        | MLG0603SR15△T□□□ |
| 238       |        |        |        |        | 7      |        |        |        |        | MLG0603SR16△T□□□ |
| 318       |        |        |        |        | 6      |        |        |        |        | MLG0603SR18△T□□□ |

\* The " △ " of the Part Number contains the inductance tolerance code, B( $\pm 0.1$ nH), C( $\pm 0.2$ nH), S( $\pm 0.3$ nH), H( $\pm 3\%$ ) or J( $\pm 5\%$ ).  
Please contact us for information on inductance tolerance, G ( $\pm 2\%$ ).

\* The " □□□ " of the Part Number contains the internal code.

○ Measurement equipment

| Product No.  | Manufacturer         |
|--------------|----------------------|
| 4291B+16197A | Agilent Technologies |

\* Equivalent measurement equipment may be used.

# MLGseries **MLG0603S Type**

## ■ ELECTRICAL CHARACTERISTICS

### □ L FREQUENCY CHARACTERISTICS GRAPH (EXAMPLE)

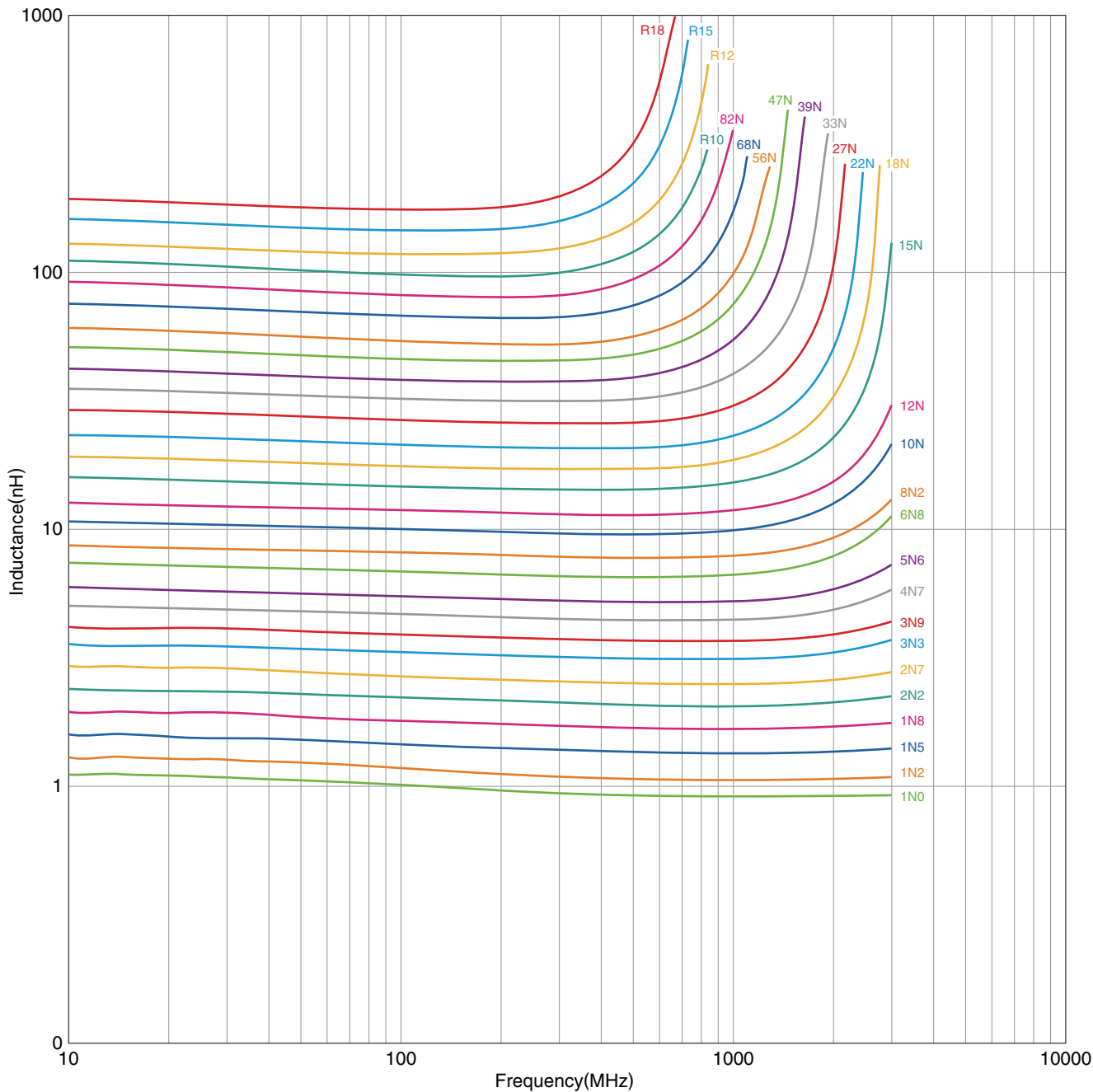

○ Measurement equipment

| Product No.    | Manufacturer         |
|----------------|----------------------|
| E4991A +16197A | Agilent Technologies |

\* Equivalent measurement equipment may be used.

• All specifications are subject to change without notice.

# MLG<sub>series</sub> MLG0603S Type

## ELECTRICAL CHARACTERISTICS

### Q FREQUENCY CHARACTERISTICS GRAPH (EXAMPLE)

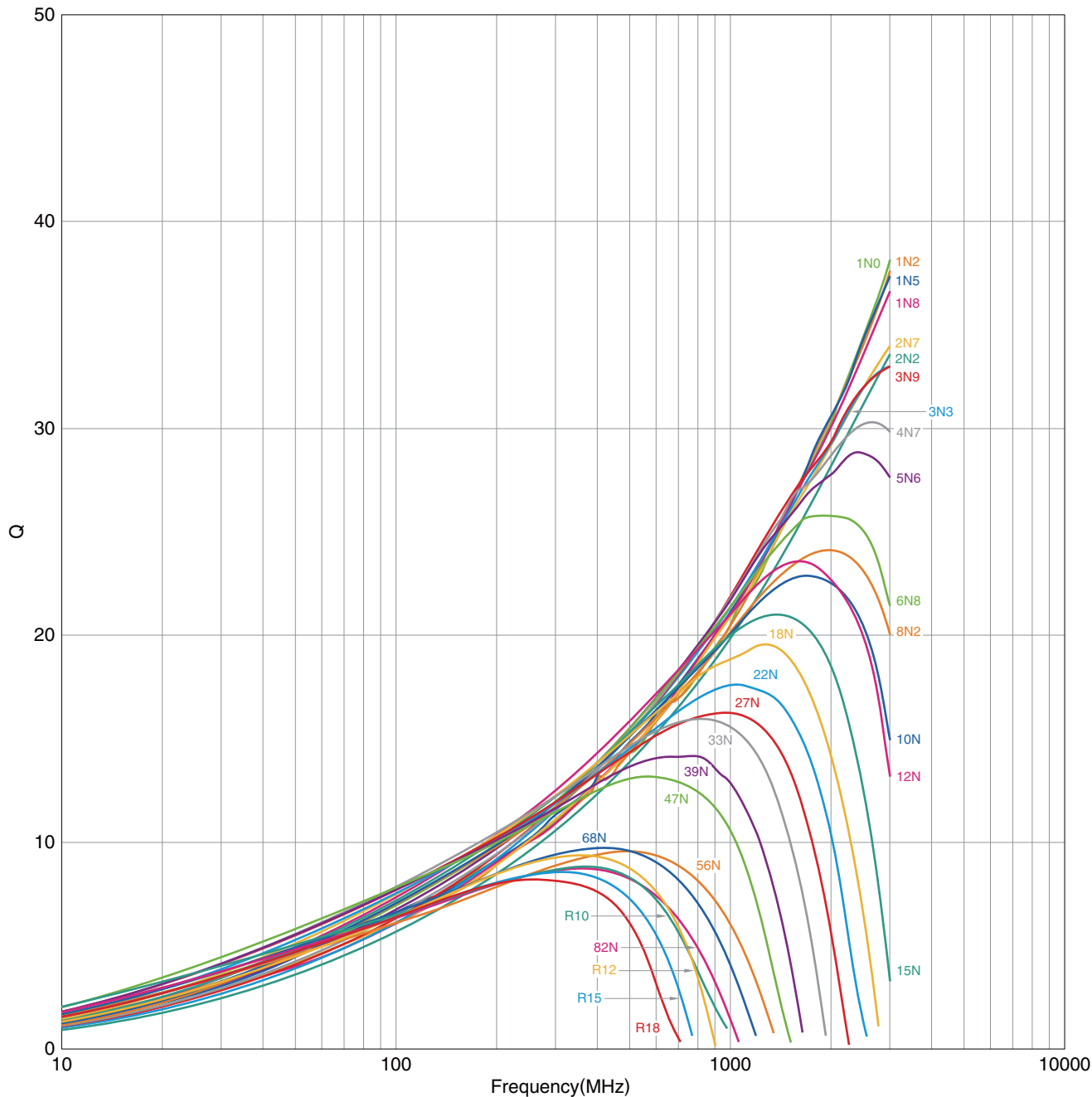

○ Measurement equipment

| Product No.    | Manufacturer         |
|----------------|----------------------|
| E4991A +16197A | Agilent Technologies |

\* Equivalent measurement equipment may be used.

• All specifications are subject to change without notice.

MLGseries

# MLG1005S Type



## ■ SHAPE & DIMENSIONS

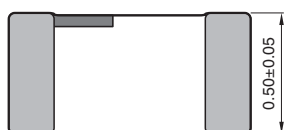
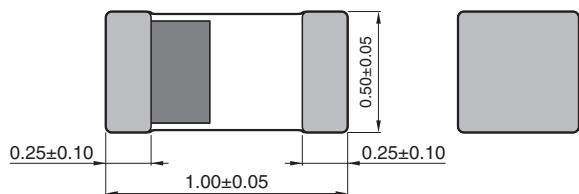

Dimensions in mm

## ■ RECOMMENDED LAND PATTERN

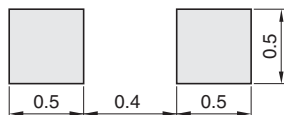

Dimensions in mm

• All specifications are subject to change without notice.

MLGseries **MLG1005S Type**

## ■ ELECTRICAL CHARACTERISTICS

## □ CHARACTERISTICS SPECIFICATION TABLE

| L<br>(nH) | Tolerance                                 | Q<br>min. | L, Q measuring<br>frequency<br>(MHz) | Self-resonant<br>frequency<br>(GHz) |      | DC resistance<br>( $\Omega$ ) |      | Rated current<br>(mA)<br>max. | Part No.*                 |
|-----------|---|-----------|--------------------------------------|-------------------------------------|------|-------------------------------|------|-------------------------------|---------------------------|
|           |   |           |                                      | min.                                | typ. | max.                          | typ. |                               |                           |
| 0.3       | $\pm 0.1\text{nH}, \pm 0.2\text{nH}$      | —         | 100                                  | 10.0                                | 20up | 0.10                          | 0.01 | 1000                          | MLG1005S0N3 $\Delta$ T□□□ |
| 0.4       | $\pm 0.1\text{nH}, \pm 0.2\text{nH}$      | —         | 100                                  | 10.0                                | 20up | 0.10                          | 0.01 | 1000                          | MLG1005S0N4 $\Delta$ T□□□ |
| 0.5       | $\pm 0.1\text{nH}, \pm 0.2\text{nH}$      | —         | 100                                  | 10.0                                | 20up | 0.10                          | 0.01 | 1000                          | MLG1005S0N5 $\Delta$ T□□□ |
| 0.6       | $\pm 0.1\text{nH}, \pm 0.2\text{nH}$      | —         | 100                                  | 10.0                                | 20up | 0.10                          | 0.01 | 1000                          | MLG1005S0N6 $\Delta$ T□□□ |
| 0.7       | $\pm 0.1\text{nH}, \pm 0.2\text{nH}$      | —         | 100                                  | 10.0                                | 18.7 | 0.10                          | 0.02 | 1000                          | MLG1005S0N7 $\Delta$ T□□□ |
| 0.8       | $\pm 0.1\text{nH}, \pm 0.2\text{nH}$      | —         | 100                                  | 10.0                                | 16.4 | 0.10                          | 0.02 | 1000                          | MLG1005S0N8 $\Delta$ T□□□ |
| 0.9       | $\pm 0.1\text{nH}, \pm 0.2\text{nH}$      | —         | 100                                  | 10.0                                | 17.7 | 0.10                          | 0.04 | 1000                          | MLG1005S0N9 $\Delta$ T□□□ |
| 1.0       | $\pm 0.1\text{nH}, \pm 0.2, 0.3\text{nH}$ | 7         | 100                                  | 10.0                                | 13.8 | 0.10                          | 0.04 | 1000                          | MLG1005S1N0 $\Delta$ T□□□ |
| 1.1       | $\pm 0.1\text{nH}, \pm 0.2, 0.3\text{nH}$ | 7         | 100                                  | 10.0                                | 19.3 | 0.10                          | 0.03 | 1000                          | MLG1005S1N1 $\Delta$ T□□□ |
| 1.2       | $\pm 0.1\text{nH}, \pm 0.2, 0.3\text{nH}$ | 7         | 100                                  | 10.0                                | 11.6 | 0.10                          | 0.04 | 1000                          | MLG1005S1N2 $\Delta$ T□□□ |
| 1.3       | $\pm 0.1\text{nH}, \pm 0.2, 0.3\text{nH}$ | 7         | 100                                  | 8.00                                | 11.7 | 0.10                          | 0.04 | 1000                          | MLG1005S1N3 $\Delta$ T□□□ |
| 1.5       | $\pm 0.1\text{nH}, \pm 0.2, 0.3\text{nH}$ | 7         | 100                                  | 8.00                                | 9.6  | 0.10                          | 0.06 | 1000                          | MLG1005S1N5 $\Delta$ T□□□ |
| 1.6       | $\pm 0.1\text{nH}, \pm 0.2, 0.3\text{nH}$ | 7         | 100                                  | 7.50                                | 9.4  | 0.12                          | 0.05 | 1000                          | MLG1005S1N6 $\Delta$ T□□□ |
| 1.8       | $\pm 0.1\text{nH}, \pm 0.2, 0.3\text{nH}$ | 7         | 100                                  | 8.00                                | 10.3 | 0.15                          | 0.06 | 900                           | MLG1005S1N8 $\Delta$ T□□□ |
| 2.0       | $\pm 0.1\text{nH}, \pm 0.2, 0.3\text{nH}$ | 7         | 100                                  | 7.50                                | 9.3  | 0.15                          | 0.07 | 900                           | MLG1005S2N0 $\Delta$ T□□□ |
| 2.2       | $\pm 0.1\text{nH}, \pm 0.2, 0.3\text{nH}$ | 7         | 100                                  | 7.00                                | 8.6  | 0.15                          | 0.08 | 900                           | MLG1005S2N2 $\Delta$ T□□□ |
| 2.4       | $\pm 0.1\text{nH}, \pm 0.2, 0.3\text{nH}$ | 7         | 100                                  | 7.00                                | 8.2  | 0.15                          | 0.08 | 800                           | MLG1005S2N4 $\Delta$ T□□□ |
| 2.7       | $\pm 0.1\text{nH}, \pm 0.2, 0.3\text{nH}$ | 7         | 100                                  | 6.00                                | 7.3  | 0.15                          | 0.08 | 800                           | MLG1005S2N7 $\Delta$ T□□□ |
| 3.0       | $\pm 0.1\text{nH}, \pm 0.2, 0.3\text{nH}$ | 7         | 100                                  | 5.50                                | 6.8  | 0.20                          | 0.09 | 800                           | MLG1005S3N0 $\Delta$ T□□□ |
| 3.3       | $\pm 0.1\text{nH}, \pm 0.2, 0.3\text{nH}$ | 8         | 100                                  | 5.00                                | 6.1  | 0.20                          | 0.09 | 800                           | MLG1005S3N3 $\Delta$ T□□□ |
| 3.6       | $\pm 0.1\text{nH}, \pm 0.2, 0.3\text{nH}$ | 8         | 100                                  | 5.00                                | 6.7  | 0.20                          | 0.09 | 700                           | MLG1005S3N6 $\Delta$ T□□□ |
| 3.9       | $\pm 0.1\text{nH}, \pm 0.2, 0.3\text{nH}$ | 8         | 100                                  | 5.00                                | 6.5  | 0.20                          | 0.11 | 700                           | MLG1005S3N9 $\Delta$ T□□□ |
| 4.3       | $\pm 0.2\text{nH}, \pm 0.3\text{nH}$      | 8         | 100                                  | 4.50                                | 6.0  | 0.20                          | 0.11 | 700                           | MLG1005S4N3 $\Delta$ T□□□ |
| 4.7       | $\pm 0.2\text{nH}, \pm 0.3\text{nH}$      | 8         | 100                                  | 4.50                                | 5.4  | 0.25                          | 0.12 | 700                           | MLG1005S4N7 $\Delta$ T□□□ |
| 5.1       | $\pm 0.2\text{nH}, \pm 0.3\text{nH}$      | 8         | 100                                  | 4.00                                | 5.0  | 0.25                          | 0.13 | 600                           | MLG1005S5N1 $\Delta$ T□□□ |
| 5.6       | $\pm 0.2\text{nH}, \pm 0.3\text{nH}$      | 8         | 100                                  | 4.00                                | 5.3  | 0.25                          | 0.14 | 600                           | MLG1005S5N6 $\Delta$ T□□□ |
| 6.2       | $\pm 3\%, \pm 0.3\text{nH}$               | 8         | 100                                  | 4.00                                | 4.7  | 0.25                          | 0.16 | 600                           | MLG1005S6N2 $\Delta$ T□□□ |
| 6.8       | $\pm 3\%, \pm 5\%$                        | 8         | 100                                  | 3.50                                | 4.4  | 0.25                          | 0.15 | 600                           | MLG1005S6N8 $\Delta$ T□□□ |
| 7.5       | $\pm 3\%, \pm 5\%$                        | 8         | 100                                  | 3.00                                | 4.1  | 0.25                          | 0.15 | 500                           | MLG1005S7N5 $\Delta$ T□□□ |
| 8.2       | $\pm 3\%, \pm 5\%$                        | 8         | 100                                  | 3.00                                | 4.0  | 0.30                          | 0.19 | 500                           | MLG1005S8N2 $\Delta$ T□□□ |
| 9.1       | $\pm 3\%, \pm 5\%$                        | 8         | 100                                  | 3.00                                | 3.8  | 0.30                          | 0.20 | 500                           | MLG1005S9N1 $\Delta$ T□□□ |
| 10        | $\pm 3\%, \pm 5\%$                        | 8         | 100                                  | 2.50                                | 3.4  | 0.35                          | 0.22 | 500                           | MLG1005S10N $\Delta$ T□□□ |
| 11        | $\pm 3\%, \pm 5\%$                        | 8         | 100                                  | 2.50                                | 3.5  | 0.40                          | 0.28 | 400                           | MLG1005S11N $\Delta$ T□□□ |
| 12        | $\pm 3\%, \pm 5\%$                        | 8         | 100                                  | 2.50                                | 3.0  | 0.40                          | 0.25 | 400                           | MLG1005S12N $\Delta$ T□□□ |
| 13        | $\pm 3\%, \pm 5\%$                        | 8         | 100                                  | 2.40                                | 2.9  | 0.50                          | 0.26 | 400                           | MLG1005S13N $\Delta$ T□□□ |
| 15        | $\pm 3\%, \pm 5\%$                        | 8         | 100                                  | 2.20                                | 2.8  | 0.55                          | 0.35 | 400                           | MLG1005S15N $\Delta$ T□□□ |
| 16        | $\pm 3\%, \pm 5\%$                        | 8         | 100                                  | 2.10                                | 2.7  | 0.55                          | 0.32 | 400                           | MLG1005S16N $\Delta$ T□□□ |
| 18        | $\pm 3\%, \pm 5\%$                        | 8         | 100                                  | 2.00                                | 2.5  | 0.60                          | 0.40 | 350                           | MLG1005S18N $\Delta$ T□□□ |
| 20        | $\pm 3\%, \pm 5\%$                        | 8         | 100                                  | 1.90                                | 2.4  | 0.60                          | 0.38 | 350                           | MLG1005S20N $\Delta$ T□□□ |
| 22        | $\pm 3\%, \pm 5\%$                        | 8         | 100                                  | 1.70                                | 2.2  | 0.70                          | 0.46 | 350                           | MLG1005S22N $\Delta$ T□□□ |
| 24        | $\pm 3\%, \pm 5\%$                        | 8         | 100                                  | 1.70                                | 2.1  | 0.70                          | 0.43 | 350                           | MLG1005S24N $\Delta$ T□□□ |
| 27        | $\pm 3\%, \pm 5\%$                        | 8         | 100                                  | 1.60                                | 2.0  | 0.80                          | 0.53 | 300                           | MLG1005S27N $\Delta$ T□□□ |
| 30        | $\pm 3\%, \pm 5\%$                        | 8         | 100                                  | 1.50                                | 1.9  | 0.80                          | 0.50 | 300                           | MLG1005S30N $\Delta$ T□□□ |

\* The " $\Delta$ " of the Part Number contains the inductance tolerance code, B( $\pm 0.1\text{nH}$ ), C( $\pm 0.2\text{nH}$ ), S( $\pm 0.3\text{nH}$ ), H( $\pm 3\%$ ) or J( $\pm 5\%$ ).

Please contact us for information on inductance tolerance, G ( $\pm 2\%$ ).

\* The "□□□" of the Part Number contains the internal code.

## ○ Measurement equipment

| Measurement item        | Product No.   | Manufacturer         |
|-------------------------|---------------|----------------------|
| L, Q                    | 4291B +16193A | Agilent Technologies |
| Self-resonant frequency | 8720C         | Agilent Technologies |
| DC resistance           | Type-7561     | Yokogawa             |

\* Equivalent measurement equipment may be used.

• All specifications are subject to change without notice.

MLGseries **MLG1005S Type**

## ■ ELECTRICAL CHARACTERISTICS

## □ CHARACTERISTICS SPECIFICATION TABLE

| L<br>(nH) | Tolerance             | Q<br>min. | L, Q measuring<br>frequency<br>(MHz) | Self-resonant<br>frequency<br>(GHz) |      | DC resistance<br>( $\Omega$ ) |      | Rated current<br>(mA)<br>max. | Part No.*                 |
|-----------|-----------------------|-----------|--------------------------------------|-------------------------------------|------|-------------------------------|------|-------------------------------|---------------------------|
|           |                       |           |                                      | min.                                | typ. | max.                          | typ. |                               |                           |
| 33        | $\pm 3\%$ , $\pm 5\%$ | 8         | 100                                  | 1.40                                | 1.8  | 0.90                          | 0.59 | 300                           | MLG1005S33N $\Delta$ T□□□ |
| 36        | $\pm 3\%$ , $\pm 5\%$ | 8         | 100                                  | 1.30                                | 1.7  | 1.00                          | 0.62 | 250                           | MLG1005S36N $\Delta$ T□□□ |
| 39        | $\pm 3\%$ , $\pm 5\%$ | 8         | 100                                  | 1.20                                | 1.6  | 1.00                          | 0.65 | 250                           | MLG1005S39N $\Delta$ T□□□ |
| 43        | $\pm 3\%$ , $\pm 5\%$ | 8         | 100                                  | 1.20                                | 1.6  | 1.10                          | 0.67 | 250                           | MLG1005S43N $\Delta$ T□□□ |
| 47        | $\pm 3\%$ , $\pm 5\%$ | 8         | 100                                  | 1.10                                | 1.4  | 1.20                          | 0.75 | 250                           | MLG1005S47N $\Delta$ T□□□ |
| 51        | $\pm 3\%$ , $\pm 5\%$ | 8         | 100                                  | 1.10                                | 1.5  | 1.20                          | 0.72 | 250                           | MLG1005S51N $\Delta$ T□□□ |
| 56        | $\pm 3\%$ , $\pm 5\%$ | 8         | 100                                  | 1.00                                | 1.3  | 1.30                          | 0.83 | 200                           | MLG1005S56N $\Delta$ T□□□ |
| 62        | $\pm 3\%$ , $\pm 5\%$ | 8         | 100                                  | 1.00                                | 1.3  | 1.40                          | 0.85 | 200                           | MLG1005S62N $\Delta$ T□□□ |
| 68        | $\pm 3\%$ , $\pm 5\%$ | 8         | 100                                  | 0.80                                | 1.1  | 1.50                          | 0.87 | 200                           | MLG1005S68N $\Delta$ T□□□ |
| 75        | $\pm 3\%$ , $\pm 5\%$ | 8         | 100                                  | 0.75                                | 1.1  | 1.50                          | 0.93 | 200                           | MLG1005S75N $\Delta$ T□□□ |
| 82        | $\pm 3\%$ , $\pm 5\%$ | 8         | 100                                  | 0.70                                | 1.0  | 1.60                          | 1.01 | 200                           | MLG1005S82N $\Delta$ T□□□ |
| 91        | $\pm 3\%$ , $\pm 5\%$ | 8         | 100                                  | 0.70                                | 0.9  | 1.80                          | 1.14 | 200                           | MLG1005S91N $\Delta$ T□□□ |
| 100       | $\pm 3\%$ , $\pm 5\%$ | 8         | 100                                  | 0.70                                | 0.9  | 2.00                          | 1.37 | 200                           | MLG1005SR10 $\Delta$ T□□□ |
| 110       | $\pm 3\%$ , $\pm 5\%$ | 8         | 100                                  | 0.70                                | 0.9  | 2.20                          | 1.48 | 150                           | MLG1005SR11 $\Delta$ T□□□ |
| 120       | $\pm 3\%$ , $\pm 5\%$ | 8         | 100                                  | 0.60                                | 0.8  | 2.20                          | 1.48 | 150                           | MLG1005SR12 $\Delta$ T□□□ |
| 130       | $\pm 3\%$ , $\pm 5\%$ | 8         | 100                                  | 0.60                                | 0.8  | 2.50                          | 1.68 | 150                           | MLG1005SR13 $\Delta$ T□□□ |
| 150       | $\pm 3\%$ , $\pm 5\%$ | 8         | 100                                  | 0.55                                | 0.7  | 3.50                          | 2.44 | 150                           | MLG1005SR15 $\Delta$ T□□□ |
| 160       | $\pm 3\%$ , $\pm 5\%$ | 8         | 100                                  | 0.50                                | 0.6  | 3.80                          | 2.74 | 150                           | MLG1005SR16 $\Delta$ T□□□ |
| 180       | $\pm 3\%$ , $\pm 5\%$ | 8         | 100                                  | 0.50                                | 0.6  | 3.80                          | 2.88 | 150                           | MLG1005SR18 $\Delta$ T□□□ |
| 200       | $\pm 3\%$ , $\pm 5\%$ | 8         | 100                                  | 0.42                                | 0.5  | 4.20                          | 3.15 | 100                           | MLG1005SR20 $\Delta$ T□□□ |
| 220       | $\pm 3\%$ , $\pm 5\%$ | 8         | 100                                  | 0.45                                | 0.5  | 4.20                          | 3.02 | 100                           | MLG1005SR22 $\Delta$ T□□□ |
| 240       | $\pm 3\%$ , $\pm 5\%$ | 8         | 100                                  | 0.40                                | 0.5  | 4.80                          | 3.42 | 100                           | MLG1005SR24 $\Delta$ T□□□ |
| 270       | $\pm 3\%$ , $\pm 5\%$ | 8         | 100                                  | 0.40                                | 0.5  | 4.80                          | 3.54 | 100                           | MLG1005SR27 $\Delta$ T□□□ |
| 300       | $\pm 3\%$ , $\pm 5\%$ | 6         | 50                                   | 0.35                                | 0.4  | 6.50                          | 4.82 | 50                            | MLG1005SR30 $\Delta$ T□□□ |
| 330       | $\pm 3\%$ , $\pm 5\%$ | 6         | 50                                   | 0.35                                | 0.4  | 7.00                          | 5.21 | 50                            | MLG1005SR33 $\Delta$ T□□□ |
| 360       | $\pm 3\%$ , $\pm 5\%$ | 6         | 50                                   | 0.30                                | 0.4  | 7.50                          | 5.39 | 50                            | MLG1005SR36 $\Delta$ T□□□ |
| 390       | $\pm 3\%$ , $\pm 5\%$ | 6         | 50                                   | 0.30                                | 0.4  | 8.00                          | 5.97 | 50                            | MLG1005SR39 $\Delta$ T□□□ |

\* The " $\Delta$ " of the Part Number contains the inductance tolerance code, B( $\pm 0.1\text{nH}$ ), C( $\pm 0.2\text{nH}$ ), S( $\pm 0.3\text{nH}$ ), H( $\pm 3\%$ ) or J( $\pm 5\%$ ).  
Please contact us for information on inductance tolerance, G ( $\pm 2\%$ ).

\* The "□□□" of the Part Number contains the internal code.

## ○ Measurement equipment

| Measurement item        | Product No.   | Manufacturer         |
|-------------------------|---------------|----------------------|
| L, Q                    | 4291B +16193A | Agilent Technologies |
| Self-resonant frequency | 8720C         | Agilent Technologies |
| DC resistance           | Type-7561     | Yokogawa             |

\* Equivalent measurement equipment may be used.

MLGseries **MLG1005S Type**

## ■ ELECTRICAL CHARACTERISTICS

## □ L, Q FREQUENCY CHARACTERISTICS TABLE

| L(nH)typ. |        |        |        |        | Q typ. |        |        |        |        | Part No.*           |
|-----------|--------|--------|--------|--------|--------|--------|--------|--------|--------|---------------------|
| 500MHz    | 800MHz | 1.8GHz | 2.0GHz | 2.4GHz | 500MHz | 800MHz | 1.8GHz | 2.0GHz | 2.4GHz |                     |
| 0.3       | 0.3    | 0.3    | 0.3    | 0.3    | 22min. | 27min. | 46min. | 49min. | 53min. | MLG1005S0N3 △ T □□□ |
| 0.4       | 0.4    | 0.4    | 0.4    | 0.4    | 22min. | 27min. | 46min. | 49min. | 53min. | MLG1005S0N4 △ T □□□ |
| 0.5       | 0.5    | 0.5    | 0.5    | 0.5    | 22min. | 27min. | 46min. | 49min. | 53min. | MLG1005S0N5 △ T □□□ |
| 0.6       | 0.6    | 0.6    | 0.6    | 0.6    | 22     | 27     | 46     | 49     | 53     | MLG1005S0N6 △ T □□□ |
| 0.7       | 0.7    | 0.7    | 0.7    | 0.7    | 22     | 28     | 45     | 49     | 54     | MLG1005S0N7 △ T □□□ |
| 0.8       | 0.8    | 0.8    | 0.8    | 0.8    | 26     | 34     | 57     | 60     | 66     | MLG1005S0N8 △ T □□□ |
| 0.9       | 0.8    | 0.8    | 0.8    | 0.8    | 21     | 27     | 44     | 47     | 53     | MLG1005S0N9 △ T □□□ |
| 0.9       | 0.9    | 0.9    | 0.9    | 0.9    | 22     | 29     | 48     | 50     | 56     | MLG1005S1N0 △ T □□□ |
| 1.0       | 1.0    | 1.0    | 1.0    | 1.0    | 23     | 29     | 47     | 50     | 57     | MLG1005S1N1 △ T □□□ |
| 1.1       | 1.1    | 1.1    | 1.1    | 1.1    | 23     | 29     | 48     | 50     | 56     | MLG1005S1N2 △ T □□□ |
| 1.2       | 1.2    | 1.2    | 1.2    | 1.2    | 22     | 27     | 44     | 47     | 53     | MLG1005S1N3 △ T □□□ |
| 1.4       | 1.4    | 1.4    | 1.5    | 1.5    | 23     | 29     | 47     | 50     | 56     | MLG1005S1N5 △ T □□□ |
| 1.5       | 1.5    | 1.5    | 1.6    | 1.6    | 23     | 29     | 46     | 49     | 54     | MLG1005S1N6 △ T □□□ |
| 1.7       | 1.7    | 1.7    | 1.7    | 1.7    | 20     | 26     | 41     | 43     | 49     | MLG1005S1N8 △ T □□□ |
| 1.9       | 1.9    | 1.9    | 1.9    | 1.9    | 21     | 25     | 41     | 43     | 48     | MLG1005S2N0 △ T □□□ |
| 2.1       | 2.1    | 2.1    | 2.1    | 2.2    | 22     | 27     | 44     | 47     | 52     | MLG1005S2N2 △ T □□□ |
| 2.3       | 2.3    | 2.3    | 2.3    | 2.4    | 21     | 26     | 42     | 44     | 49     | MLG1005S2N4 △ T □□□ |
| 2.6       | 2.6    | 2.6    | 2.7    | 2.7    | 22     | 27     | 43     | 45     | 50     | MLG1005S2N7 △ T □□□ |
| 2.9       | 2.9    | 3.0    | 3.0    | 3.1    | 24     | 29     | 47     | 49     | 54     | MLG1005S3N0 △ T □□□ |
| 3.2       | 3.2    | 3.3    | 3.4    | 3.5    | 24     | 30     | 46     | 48     | 53     | MLG1005S3N3 △ T □□□ |
| 3.4       | 3.4    | 3.6    | 3.6    | 3.8    | 21     | 26     | 40     | 42     | 46     | MLG1005S3N6 △ T □□□ |
| 3.7       | 3.7    | 3.9    | 3.9    | 4.1    | 22     | 28     | 43     | 45     | 50     | MLG1005S3N9 △ T □□□ |
| 4.1       | 4.1    | 4.3    | 4.4    | 4.6    | 24     | 30     | 47     | 49     | 53     | MLG1005S4N3 △ T □□□ |
| 4.5       | 4.5    | 4.8    | 4.9    | 5.2    | 23     | 30     | 45     | 47     | 50     | MLG1005S4N7 △ T □□□ |
| 4.9       | 4.9    | 5.4    | 5.6    | 6.1    | 23     | 29     | 42     | 43     | 44     | MLG1005S5N1 △ T □□□ |
| 5.4       | 5.4    | 5.8    | 5.9    | 6.3    | 22     | 28     | 42     | 43     | 45     | MLG1005S5N6 △ T □□□ |
| 6.0       | 6.0    | 6.8    | 7.1    | 7.8    | 24     | 29     | 42     | 43     | 43     | MLG1005S6N2 △ T □□□ |
| 6.5       | 6.6    | 7.4    | 7.8    | 8.6    | 23     | 28     | 40     | 41     | 41     | MLG1005S6N8 △ T □□□ |
| 7.2       | 7.4    | 8.6    | 9.2    | 10.5   | 24     | 30     | 41     | 41     | 39     | MLG1005S7N5 △ T □□□ |
| 7.9       | 8.0    | 9.3    | 9.9    | 11.3   | 23     | 28     | 38     | 38     | 36     | MLG1005S8N2 △ T □□□ |
| 8.8       | 9.0    | 10.8   | 11.6   | 13.7   | 24     | 30     | 40     | 39     | 36     | MLG1005S9N1 △ T □□□ |
| 9.7       | 9.9    | 12.4   | 13.5   | 16.7   | 24     | 30     | 37     | 36     | 31     | MLG1005S10N △ T □□□ |
| 10.6      | 10.9   | 13.8   | 15.1   | 19.0   | 23     | 28     | 34     | 33     | 28     | MLG1005S11N △ T □□□ |
| 11.7      | 12.1   | 16.2   | 18.3   |        | 23     | 29     | 33     | 31     |        | MLG1005S12N △ T □□□ |
| 12.6      | 13.0   | 18.3   | 21.3   |        | 20     | 24     | 25     | 22     |        | MLG1005S13N △ T □□□ |
| 14.7      | 15.3   | 22.0   | 26.0   |        | 23     | 28     | 29     | 26     |        | MLG1005S15N △ T □□□ |
| 15.6      | 16.2   | 24.1   | 29.0   |        | 22     | 26     | 26     | 22     |        | MLG1005S16N △ T □□□ |
| 17.7      | 18.6   | 29.0   |        |        | 23     | 28     | 26     |        |        | MLG1005S18N △ T □□□ |
| 19.7      | 20.8   | 36.8   |        |        | 21     | 25     | 21     |        |        | MLG1005S20N △ T □□□ |
| 21.8      | 23.3   |        |        |        | 22     | 27     |        |        |        | MLG1005S22N △ T □□□ |
| 23.8      | 25.5   |        |        |        | 22     | 26     |        |        |        | MLG1005S24N △ T □□□ |
| 27.0      | 29.6   |        |        |        | 20     | 23     |        |        |        | MLG1005S27N △ T □□□ |
| 30.1      | 33.5   |        |        |        | 19     | 21     |        |        |        | MLG1005S30N △ T □□□ |

\* The "△" of the Part Number contains the inductance tolerance code, B( $\pm 0.1$ nH), C( $\pm 0.2$ nH), S( $\pm 0.3$ nH), H( $\pm 3\%$ ) or J( $\pm 5\%$ ).  
Please contact us for information on inductance tolerance, G ( $\pm 2\%$ ).

\* The "□□□" of the Part Number contains the internal code.

## ○ Measurement equipment

| Product No.   | Manufacturer         |
|---------------|----------------------|
| 4291B +16193A | Agilent Technologies |

\* Equivalent measurement equipment may be used.

# MLG<sub>series</sub> MLG1005S Type

## ■ ELECTRICAL CHARACTERISTICS

### □ L, Q FREQUENCY CHARACTERISTICS TABLE

| L(nH)typ. |        |        |        |        | Q typ. |        |        |        |        | Part No.*           |
|-----------|--------|--------|--------|--------|--------|--------|--------|--------|--------|---------------------|
| 500MHz    | 800MHz | 1.8GHz | 2.0GHz | 2.4GHz | 500MHz | 800MHz | 1.8GHz | 2.0GHz | 2.4GHz |                     |
| 33.5      | 37.8   |        |        |        | 20     | 23     |        |        |        | MLG1005S33N △ T □□□ |
| 36.7      | 41.5   |        |        |        | 21     | 23     |        |        |        | MLG1005S36N △ T □□□ |
| 40.3      | 46.9   |        |        |        | 20     | 21     |        |        |        | MLG1005S39N △ T □□□ |
| 44.3      | 51.6   |        |        |        | 20     | 21     |        |        |        | MLG1005S43N △ T □□□ |
| 50.2      | 63.2   |        |        |        | 19     | 20     |        |        |        | MLG1005S47N △ T □□□ |
| 53.7      | 65.6   |        |        |        | 19     | 19     |        |        |        | MLG1005S51N △ T □□□ |
| 60.9      | 80.2   |        |        |        | 19     | 18     |        |        |        | MLG1005S56N △ T □□□ |
| 67.5      | 89.8   |        |        |        | 18     | 16     |        |        |        | MLG1005S62N △ T □□□ |
| 75.8      | 107.5  |        |        |        | 17     | 15     |        |        |        | MLG1005S68N △ T □□□ |
| 86.5      | 135.2  |        |        |        | 17     | 13     |        |        |        | MLG1005S75N △ T □□□ |
| 96.9      |        |        |        |        | 16     |        |        |        |        | MLG1005S82N △ T □□□ |
| 111.0     |        |        |        |        | 15     |        |        |        |        | MLG1005S91N △ T □□□ |
| 128.9     |        |        |        |        | 14     |        |        |        |        | MLG1005SR10 △ T □□□ |
| 140.8     |        |        |        |        | 15     |        |        |        |        | MLG1005SR11 △ T □□□ |
| 175.2     |        |        |        |        | 12     |        |        |        |        | MLG1005SR12 △ T □□□ |
| 187.8     |        |        |        |        | 13     |        |        |        |        | MLG1005SR13 △ T □□□ |
| 284.7     |        |        |        |        | 11     |        |        |        |        | MLG1005SR15 △ T □□□ |
|           |        |        |        |        |        |        |        |        |        | MLG1005SR16 △ T □□□ |
|           |        |        |        |        |        |        |        |        |        | MLG1005SR18 △ T □□□ |
|           |        |        |        |        |        |        |        |        |        | MLG1005SR20 △ T □□□ |
|           |        |        |        |        |        |        |        |        |        | MLG1005SR22 △ T □□□ |
|           |        |        |        |        |        |        |        |        |        | MLG1005SR24 △ T □□□ |
|           |        |        |        |        |        |        |        |        |        | MLG1005SR27 △ T □□□ |
|           |        |        |        |        |        |        |        |        |        | MLG1005SR30 △ T □□□ |
|           |        |        |        |        |        |        |        |        |        | MLG1005SR33 △ T □□□ |
|           |        |        |        |        |        |        |        |        |        | MLG1005SR36 △ T □□□ |
|           |        |        |        |        |        |        |        |        |        | MLG1005SR39 △ T □□□ |

\* The "△" of the Part Number contains the inductance tolerance code, B( $\pm 0.1$ nH), C( $\pm 0.2$ nH), S( $\pm 0.3$ nH), H( $\pm 3\%$ ) or J( $\pm 5\%$ ). Please contact us for information on inductance tolerance, G ( $\pm 2\%$ ).

\* The "□□□" of the Part Number contains the internal code.

### ○ Measurement equipment

| Product No.   | Manufacturer         |
|---------------|----------------------|
| 4291B +16193A | Agilent Technologies |

\* Equivalent measurement equipment may be used.



# MLGseries **MLG1005S Type**

## ■ ELECTRICAL CHARACTERISTICS

### □ L FREQUENCY CHARACTERISTICS GRAPH (EXAMPLE)

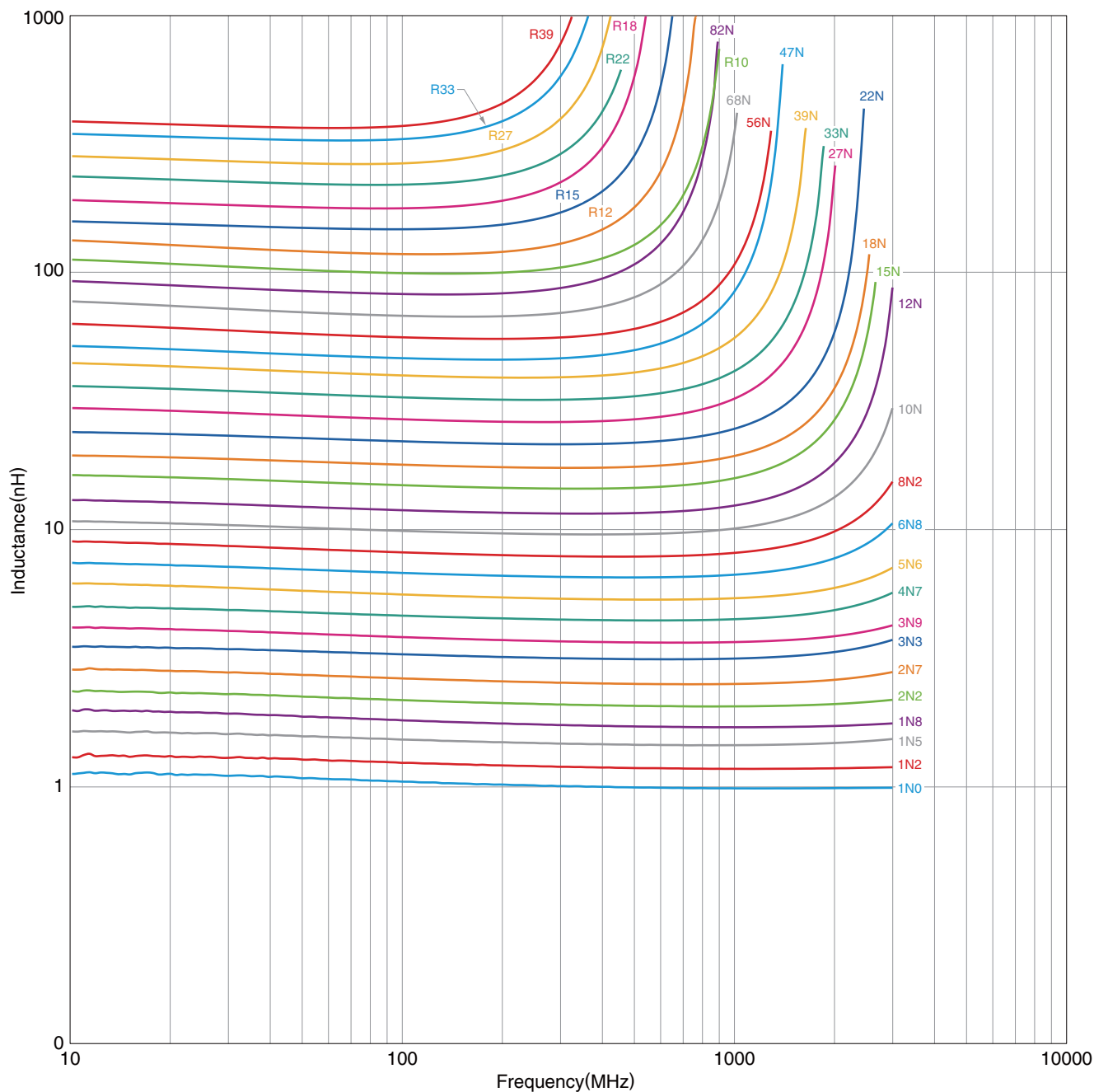

○ Measurement equipment

| Product No.    | Manufacturer         |
|----------------|----------------------|
| E4991A +16193A | Agilent Technologies |

\* Equivalent measurement equipment may be used.

• All specifications are subject to change without notice.

# MLGseries **MLG1005S Type**

## ■ ELECTRICAL CHARACTERISTICS

### □ Q FREQUENCY CHARACTERISTICS GRAPH (EXAMPLE)

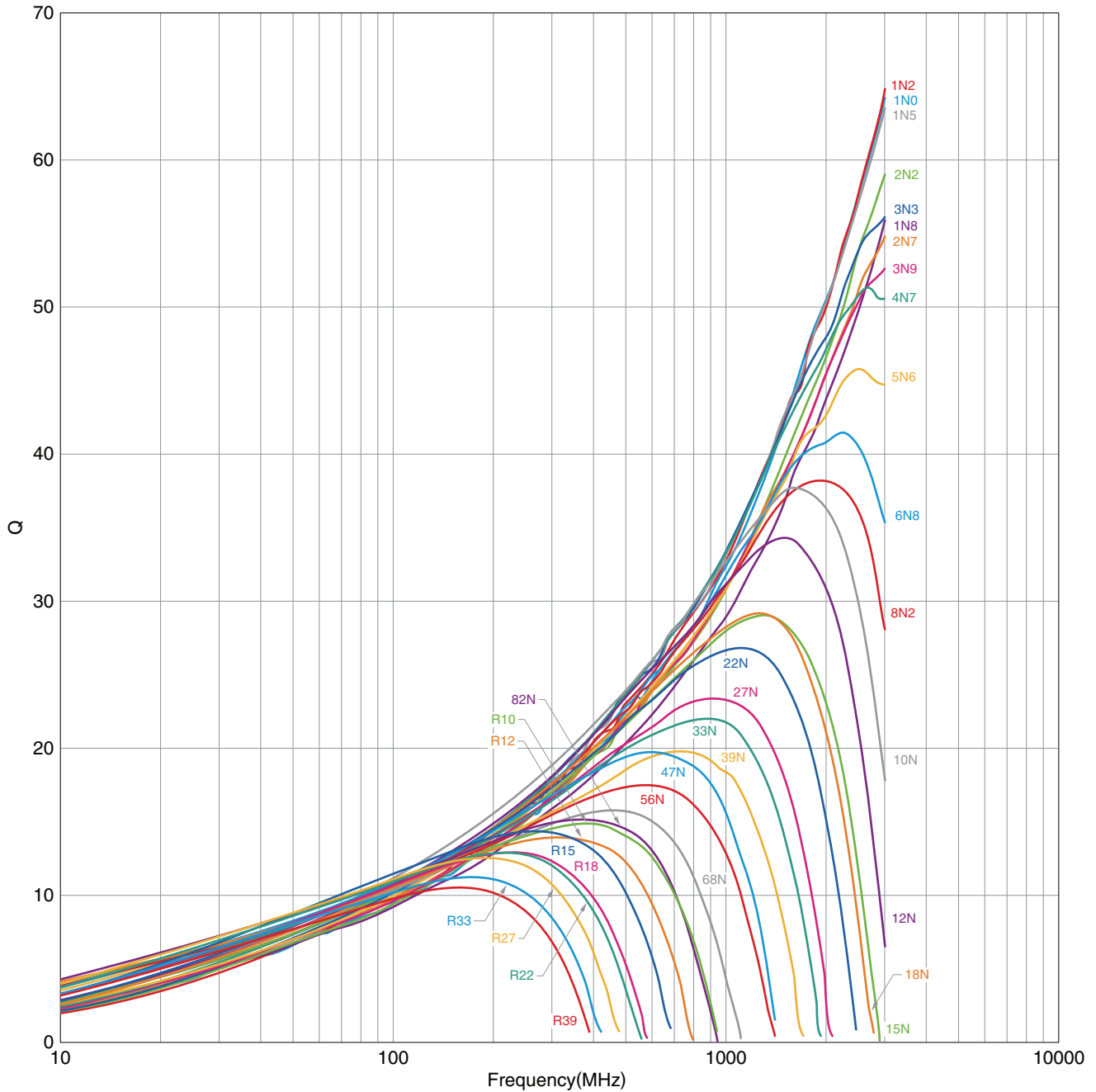

○ Measurement equipment

| Product No.    | Manufacturer         |
|----------------|----------------------|
| E4991A +16193A | Agilent Technologies |

\* Equivalent measurement equipment may be used.

• All specifications are subject to change without notice.

MLGseries

# MLG1608Type



## SHAPE & DIMENSIONS

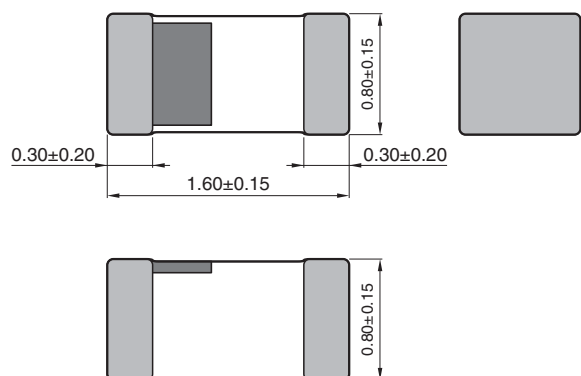

Dimensions in mm

## RECOMMENDED LAND PATTERN

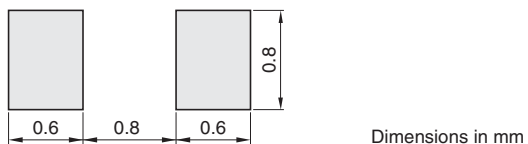

Dimensions in mm

• All specifications are subject to change without notice.

MLGseries **MLG1608 Type**

## ■ ELECTRICAL CHARACTERISTICS

## □ CHARACTERISTICS SPECIFICATION TABLE

| L<br>(nH) | Tolerance          | Q<br>min. | L, Q measuring<br>frequency<br>(MHz) | Self-resonant<br>frequency<br>(GHz) |      | DC resistance<br>( $\Omega$ ) |      | Rated current<br>(mA)<br>max. | Part No.*        |
|-----------|--------------------|-----------|--------------------------------------|-------------------------------------|------|-------------------------------|------|-------------------------------|------------------|
|           |                    |           |                                      | min.                                | typ. | max.                          | typ. |                               |                  |
| 1         | $\pm 0.3\text{nH}$ | 8         | 100                                  | 10.0                                | 20up | 0.10                          | 0.03 | 600                           | MLG1608B1N0ST□□□ |
| 1.2       | $\pm 0.3\text{nH}$ | 8         | 100                                  | 10.0                                | 20up | 0.10                          | 0.04 | 600                           | MLG1608B1N2ST□□□ |
| 1.5       | $\pm 0.3\text{nH}$ | 8         | 100                                  | 10.0                                | 19.6 | 0.10                          | 0.03 | 600                           | MLG1608B1N5ST□□□ |
| 1.8       | $\pm 0.3\text{nH}$ | 8         | 100                                  | 10.0                                | 16.6 | 0.10                          | 0.04 | 600                           | MLG1608B1N8ST□□□ |
| 2.2       | $\pm 0.3\text{nH}$ | 10        | 100                                  | 8.0                                 | 10.8 | 0.10                          | 0.05 | 600                           | MLG1608B2N2ST□□□ |
| 2.7       | $\pm 0.3\text{nH}$ | 10        | 100                                  | 7.0                                 | 8.8  | 0.12                          | 0.06 | 600                           | MLG1608B2N7ST□□□ |
| 3.3       | $\pm 0.3\text{nH}$ | 10        | 100                                  | 6.5                                 | 8.8  | 0.12                          | 0.06 | 600                           | MLG1608B3N3ST□□□ |
| 3.9       | $\pm 0.3\text{nH}$ | 10        | 100                                  | 6.0                                 | 7.9  | 0.14                          | 0.06 | 600                           | MLG1608B3N9ST□□□ |
| 4.7       | $\pm 0.3\text{nH}$ | 10        | 100                                  | 5.0                                 | 6.8  | 0.15                          | 0.08 | 600                           | MLG1608B4N7ST□□□ |
| 5.6       | $\pm 0.5\text{nH}$ | 10        | 100                                  | 5.0                                 | 6.8  | 0.16                          | 0.08 | 600                           | MLG1608B5N6DT□□□ |
| 6.8       | $\pm 0.5\text{nH}$ | 10        | 100                                  | 4.5                                 | 5.7  | 0.18                          | 0.10 | 600                           | MLG1608B6N8DT□□□ |
| 8.2       | $\pm 0.5\text{nH}$ | 10        | 100                                  | 4.5                                 | 5.6  | 0.20                          | 0.10 | 600                           | MLG1608B8N2DT□□□ |
| 10        | $\pm 5\%$          | 12        | 100                                  | 3.5                                 | 4.5  | 0.20                          | 0.11 | 600                           | MLG1608B10NJT□□□ |
| 12        | $\pm 5\%$          | 12        | 100                                  | 3.0                                 | 3.8  | 0.25                          | 0.13 | 600                           | MLG1608B12NJT□□□ |
| 15        | $\pm 5\%$          | 12        | 100                                  | 2.8                                 | 3.6  | 0.28                          | 0.14 | 600                           | MLG1608B15NJT□□□ |
| 18        | $\pm 5\%$          | 12        | 100                                  | 2.6                                 | 3.3  | 0.32                          | 0.16 | 600                           | MLG1608B18NJT□□□ |
| 22        | $\pm 5\%$          | 12        | 100                                  | 2.3                                 | 3.0  | 0.35                          | 0.19 | 500                           | MLG1608B22NJT□□□ |
| 27        | $\pm 5\%$          | 12        | 100                                  | 2.0                                 | 2.7  | 0.40                          | 0.21 | 500                           | MLG1608B27NJT□□□ |
| 33        | $\pm 5\%$          | 12        | 100                                  | 1.8                                 | 2.3  | 0.50                          | 0.25 | 500                           | MLG1608B33NJT□□□ |
| 39        | $\pm 5\%$          | 12        | 100                                  | 1.6                                 | 2.0  | 0.55                          | 0.26 | 400                           | MLG1608B39NJT□□□ |
| 47        | $\pm 5\%$          | 14        | 100                                  | 1.4                                 | 1.8  | 0.60                          | 0.35 | 400                           | MLG1608B47NJT□□□ |
| 56        | $\pm 5\%$          | 14        | 100                                  | 1.2                                 | 1.8  | 0.70                          | 0.41 | 400                           | MLG1608B56NJT□□□ |
| 68        | $\pm 5\%$          | 14        | 100                                  | 1.1                                 | 1.6  | 0.75                          | 0.43 | 300                           | MLG1608B68NJT□□□ |
| 82        | $\pm 5\%$          | 14        | 100                                  | 1.0                                 | 1.4  | 0.80                          | 0.50 | 300                           | MLG1608B82NJT□□□ |
| 100       | $\pm 5\%$          | 14        | 100                                  | 0.80                                | 1.2  | 1.00                          | 0.64 | 300                           | MLG1608BR10JT□□□ |
| 120       | $\pm 5\%$          | 14        | 100                                  | 0.65                                | 0.8  | 1.20                          | 0.89 | 300                           | MLG1608SR12JT□□□ |
| 150       | $\pm 5\%$          | 14        | 100                                  | 0.55                                | 0.7  | 1.30                          | 1.03 | 250                           | MLG1608SR15JT□□□ |
| 180       | $\pm 5\%$          | 14        | 100                                  | 0.50                                | 0.6  | 1.40                          | 1.08 | 250                           | MLG1608SR18JT□□□ |
| 220       | $\pm 5\%$          | 14        | 100                                  | 0.45                                | 0.6  | 1.70                          | 1.29 | 200                           | MLG1608SR22JT□□□ |
| 270       | $\pm 5\%$          | 14        | 100                                  | 0.35                                | 0.5  | 2.00                          | 1.59 | 200                           | MLG1608SR27JT□□□ |
| 330       | $\pm 5\%$          | 10        | 50                                   | 0.35                                | 0.47 | 2.80                          | 1.90 | 100                           | MLG1608SR33JT□□□ |
| 390       | $\pm 5\%$          | 10        | 50                                   | 0.30                                | 0.43 | 3.00                          | 2.06 | 100                           | MLG1608SR39JT□□□ |
| 470       | $\pm 5\%$          | 10        | 50                                   | 0.25                                | 0.39 | 3.50                          | 2.47 | 100                           | MLG1608SR47JT□□□ |
| 560       | $\pm 5\%$          | 10        | 50                                   | 0.25                                | 0.36 | 4.50                          | 3.20 | 70                            | MLG1608SR56JT□□□ |
| 680       | $\pm 5\%$          | 10        | 50                                   | 0.20                                | 0.31 | 5.50                          | 3.88 | 70                            | MLG1608SR68JT□□□ |
| 820       | $\pm 5\%$          | 10        | 50                                   | 0.15                                | 0.22 | 5.50                          | 3.76 | 70                            | MLG1608SR82JT□□□ |
| 1000      | $\pm 5\%$          | 10        | 50                                   | 0.13                                | 0.19 | 5.50                          | 4.27 | 70                            | MLG1608SR10JT□□□ |

\* The "□□□" of the Part Number contains the internal code.  
Because it provides for a product of smaller inductance tolerance, please refer.

## ○ Measurement equipment

| Measurement item        | Product No.   | Manufacturer         |
|-------------------------|---------------|----------------------|
| L, Q                    | 4291B +16193A | Agilent Technologies |
| Self-resonant frequency | 8720C         | Panasonic            |
| DC resistance           | Type-7561     | Yokogawa             |

\* Equivalent measurement equipment may be used.

MLGseries **MLG1608 Type**

## ■ ELECTRICAL CHARACTERISTICS

## □ L, Q FREQUENCY CHARACTERISTICS TABLE

| L(nH)typ. |        |        |        |        | Q typ. |        |        |        |        | Part No.*          |
|-----------|--------|--------|--------|--------|--------|--------|--------|--------|--------|--------------------|
| 500MHz    | 800MHz | 1.8GHz | 2.0GHz | 2.4GHz | 500MHz | 800MHz | 1.8GHz | 2.0GHz | 2.4GHz |                    |
| 1.0       | 1.0    | 1.0    | 1.0    | 1.0    | 39     | 48     | 77     | 82     | 95     | MLG1608B1N0ST□□□□  |
| 1.2       | 1.1    | 1.2    | 1.2    | 1.2    | 28     | 35     | 57     | 60     | 68     | MLG1608B1N2ST□□□□  |
| 1.5       | 1.5    | 1.5    | 1.5    | 1.5    | 37     | 48     | 78     | 81     | 93     | MLG1608B1N5ST□□□□  |
| 1.8       | 1.8    | 1.8    | 1.8    | 1.8    | 38     | 48     | 77     | 81     | 95     | MLG1608B1N8ST□□□□  |
| 2.2       | 2.1    | 2.2    | 2.2    | 2.2    | 44     | 54     | 88     | 91     | 107    | MLG1608B2N2ST□□□□  |
| 2.6       | 2.6    | 2.7    | 2.7    | 2.8    | 40     | 51     | 79     | 81     | 94     | MLG1608B2N7ST□□□□  |
| 3.2       | 3.2    | 3.3    | 3.3    | 3.4    | 38     | 48     | 76     | 79     | 91     | MLG1608B3N3ST□□□□  |
| 3.8       | 3.8    | 4.0    | 4.0    | 4.1    | 40     | 50     | 79     | 81     | 93     | MLG1608B3N9ST□□□□  |
| 4.6       | 4.6    | 4.9    | 5.0    | 5.2    | 41     | 51     | 76     | 79     | 88     | MLG1608B4N7ST□□□□  |
| 5.4       | 5.5    | 5.8    | 5.9    | 6.2    | 37     | 46     | 69     | 71     | 79     | MLG1608B5N6DT□□□□  |
| 6.6       | 6.7    | 7.3    | 7.5    | 8.0    | 38     | 47     | 67     | 68     | 74     | MLG1608B6N8DT□□□□  |
| 8.0       | 8.1    | 8.9    | 9.3    | 10     | 39     | 48     | 67     | 68     | 71     | MLG1608B8N2DT□□□□  |
| 9.8       | 10.0   | 11.5   | 12.1   | 13.6   | 38     | 47     | 63     | 63     | 61     | MLG1608B10NJT□□□□  |
| 11.8      | 12.1   | 14.8   | 16.0   | 19.3   | 39     | 48     | 59     | 57     | 51     | MLG1608B12NJT□□□□  |
| 14.8      | 15.4   | 20.6   | 23.4   |        | 38     | 46     | 49     | 46     |        | MLG1608B15NJT□□□□  |
| 17.8      | 18.5   | 25.5   | 29.3   |        | 36     | 44     | 47     | 42     |        | MLG1608B18NJT□□□□  |
| 21.9      | 22.9   | 33.6   | 40.2   |        | 36     | 44     | 43     | 38     |        | MLG1608B22NJT□□□□  |
| 27.1      | 28.8   | 50.6   |        |        | 37     | 43     | 34     |        |        | MLG1608B27NJT□□□□  |
| 33.4      | 36.0   |        |        |        | 37     | 43     |        |        |        | MLG1608B33NJT□□□□  |
| 40.2      | 45.0   |        |        |        | 36     | 40     |        |        |        | MLG1608B39NJT□□□□  |
| 49.1      | 56.0   |        |        |        | 38     | 41     |        |        |        | MLG1608B47NJT□□□□  |
| 59.6      | 71.1   |        |        |        | 37     | 38     |        |        |        | MLG1608B56NJT□□□□  |
| 74.0      | 92.8   |        |        |        | 34     | 33     |        |        |        | MLG1608B68NJT□□□□  |
| 91.1      | 120.6  |        |        |        | 33     | 31     |        |        |        | MLG1608B82NJT□□□□  |
| 118       |        |        |        |        | 35     |        |        |        |        | MLG1608BR10JT□□□□  |
| 188       |        |        |        |        | 23     |        |        |        |        | MLG1608SR12JT□□□□  |
|           |        |        |        |        |        |        |        |        |        | MLG1608SR15JT□□□□  |
|           |        |        |        |        |        |        |        |        |        | MLG1608SR18JT□□□□  |
|           |        |        |        |        |        |        |        |        |        | MLG1608SR22JT□□□□  |
|           |        |        |        |        |        |        |        |        |        | MLG1608SR27JT□□□□  |
|           |        |        |        |        |        |        |        |        |        | MLG1608SR33JT□□□□  |
|           |        |        |        |        |        |        |        |        |        | MLG1608SR39JT□□□□  |
|           |        |        |        |        |        |        |        |        |        | MLG1608SR47JT□□□□  |
|           |        |        |        |        |        |        |        |        |        | MLG1608SR56JT□□□□  |
|           |        |        |        |        |        |        |        |        |        | MLG1608SR68JT□□□□  |
|           |        |        |        |        |        |        |        |        |        | MLG1608SR82JT□□□□  |
|           |        |        |        |        |        |        |        |        |        | MLG1608SR1R0JT□□□□ |

\* The "□□□" of the Part Number contains the internal code.  
Because it provides for a product of smaller inductance tolerance, please refer.

## ○ Measurement equipment

| Product No.   | Manufacturer         |
|---------------|----------------------|
| 4291B +16193A | Agilent Technologies |

\* Equivalent measurement equipment may be used.

# MLGseries **MLG1608Type**

## ■ ELECTRICAL CHARACTERISTICS

### □ L FREQUENCY CHARACTERISTICS GRAPH (EXAMPLE)

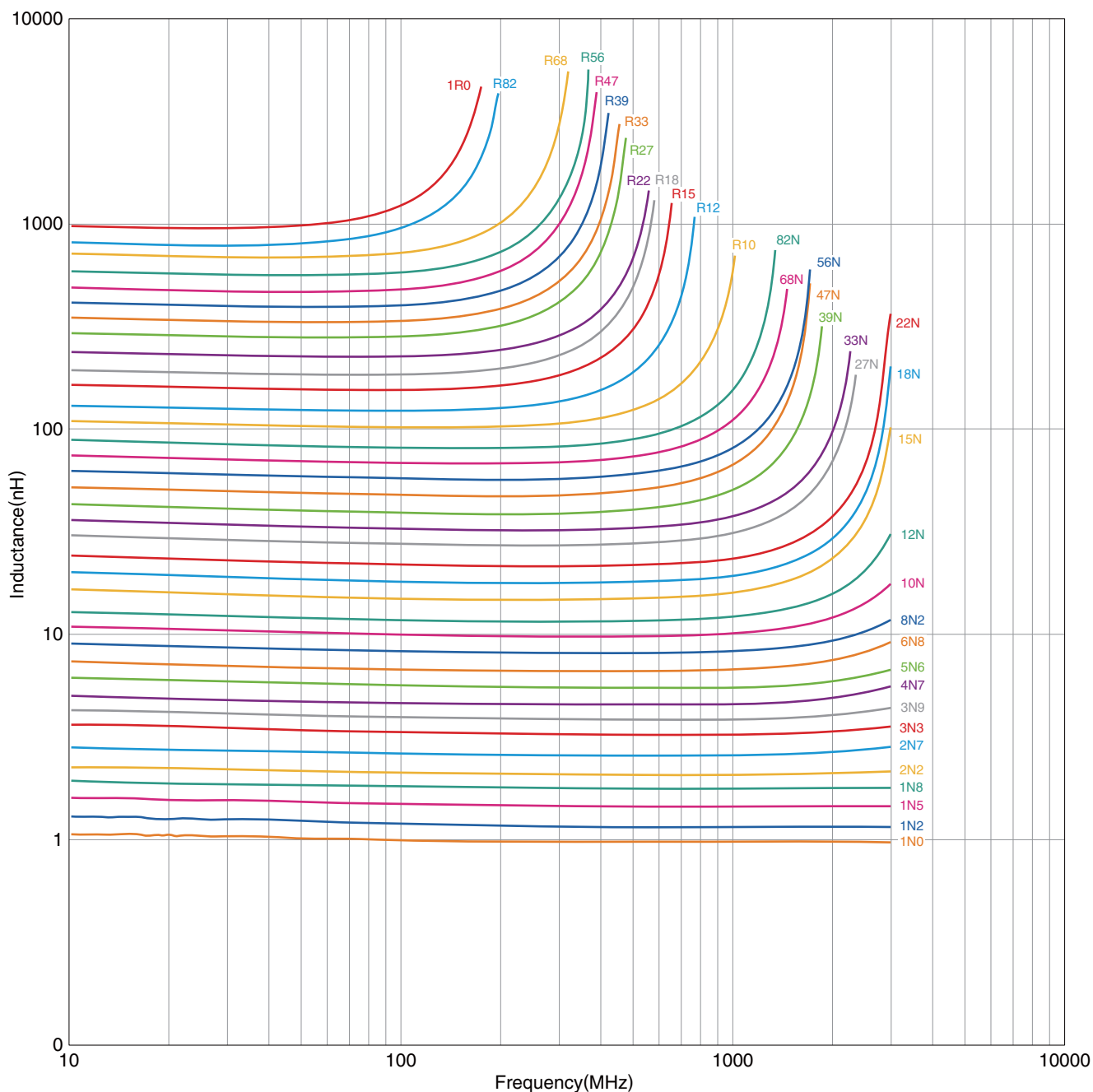

○ Measurement equipment

| Product No.    | Manufacturer         |
|----------------|----------------------|
| E4991A +16193A | Agilent Technologies |

\* Equivalent measurement equipment may be used.

• All specifications are subject to change without notice.

# MLGseries MLG1608Type

## ELECTRICAL CHARACTERISTICS

### Q FREQUENCY CHARACTERISTICS GRAPH (EXAMPLE)

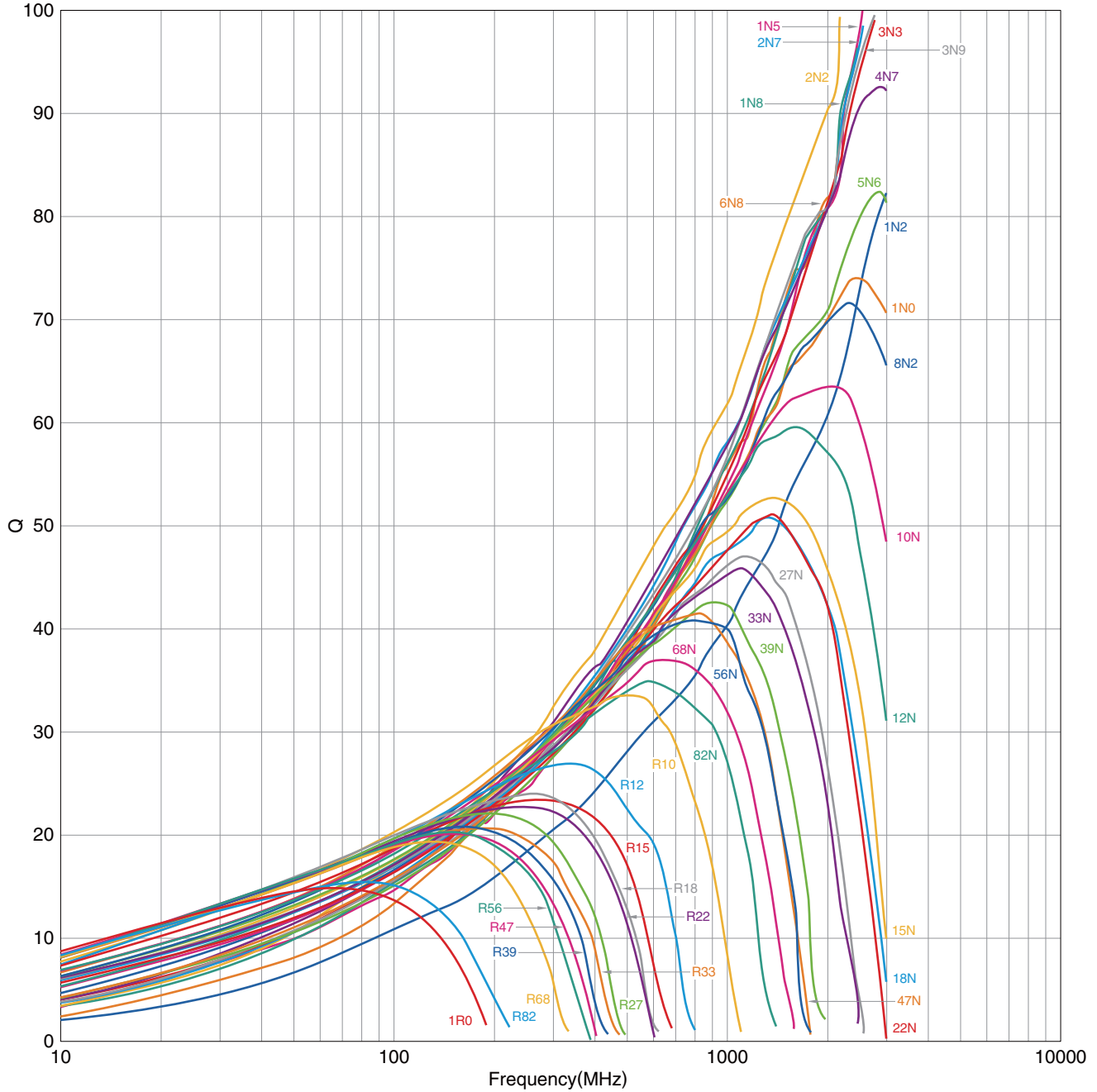

○ Measurement equipment

| Product No.    | Manufacturer         |
|----------------|----------------------|
| E4991A +16193A | Agilent Technologies |

\* Equivalent measurement equipment may be used.

• All specifications are subject to change without notice.

MLGseries

# Packaging Style

## REEL DIMENSIONS

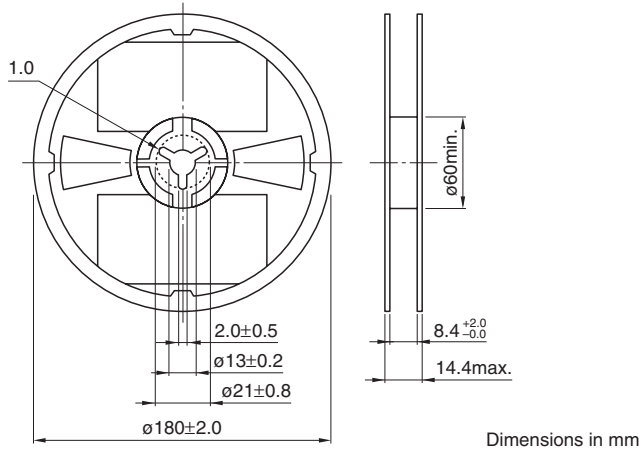

## TAPE DIMENSIONS

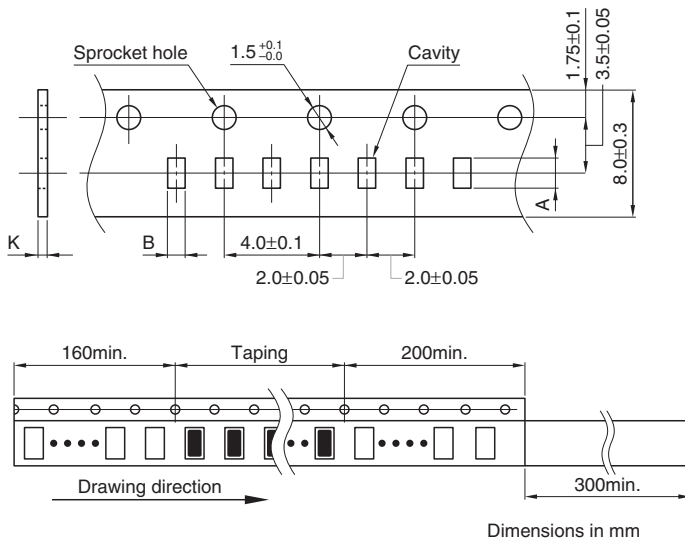

| Type            | A         | B         | K        |
|-----------------|-----------|-----------|----------|
| <b>MLG0603S</b> | 0.68±0.05 | 0.38±0.05 | 0.5 max. |
| <b>MLG1005S</b> | 1.12±0.1  | 0.62±0.1  | 0.8 max. |
| <b>MLG1608</b>  | 1.9±0.2   | 1.1±0.2   | 1.1 max. |

• All specifications are subject to change without notice.