

Inductors for Power Circuits

Wound Ferrite

SLF series

SLF6025

SLF6028

SLF6045

SLF7032

SLF7045

SLF7055

SLF10145

SLF10165

SLF12555

SLF12565

SLF12575

REMINDERS FOR USING THESE PRODUCTS

Before using these products, be sure to request the delivery specifications.

SAFETY REMINDERS

Please pay sufficient attention to the warnings for safe designing when using these products.

REMINDERS

- The storage period is less than 6 months. Be sure to follow the storage conditions (Temperature: 5 to 30°C, Humidity: 10 to 75% RH or less).
If the storage period elapses, the soldering of the terminal electrodes may deteriorate.
- Do not use or store in locations where there are conditions such as gas corrosion (salt, acid, alkali, etc.).
- Before soldering, be sure to preheat components.
The preheating temperature should be set so that the temperature difference between the solder temperature and chip temperature does not exceed 150°C.
- Soldering corrections after mounting should be within the range of the conditions determined in the specifications.
If overheated, a short circuit, performance deterioration, or lifespan shortening may occur.
- When embedding a printed circuit board where a chip is mounted to a set, be sure that residual stress is not given to the chip due to the overall distortion of the printed circuit board and partial distortion such as at screw tightening portions.
- Self heating (temperature increase) occurs when the power is turned ON, so the tolerance should be sufficient for the set thermal design.
- Carefully lay out the coil for the circuit board design of the non-magnetic shield type.
A malfunction may occur due to magnetic interference.
- Use a wrist band to discharge static electricity in your body through the grounding wire.
- Do not expose the products to magnets or magnetic fields.
- Do not use for a purpose outside of the contents regulated in the delivery specifications.
- The products listed on this catalog are intended for use in general electronic equipment (AV equipment, telecommunications equipment, home appliances, amusement equipment, computer equipment, personal equipment, office equipment, measurement equipment, industrial robots) under a normal operation and use condition.
The products are not designed or warranted to meet the requirements of the applications listed below, whose performance and/or quality require a more stringent level of safety or reliability, or whose failure, malfunction or trouble could cause serious damage to society, person or property.
If you intend to use the products in the applications listed below or if you have special requirements exceeding the range or conditions set forth in the each catalog, please contact us.

- (1) Aerospace/Aviation equipment
- (2) Transportation equipment (cars, electric trains, ships, etc.)
- (3) Medical equipment
- (4) Power-generation control equipment
- (5) Atomic energy-related equipment
- (6) Seabed equipment
- (7) Transportation control equipment

- (8) Public information-processing equipment
- (9) Military equipment
- (10) Electric heating apparatus, burning equipment
- (11) Disaster prevention/crime prevention equipment
- (12) Safety equipment
- (13) Other applications that are not considered general-purpose applications

When designing your equipment even for general-purpose applications, you are kindly requested to take into consideration securing protection circuit/device or providing backup circuits in your equipment.

Inductors for Power Circuits

Product compatible with RoHS directive
Compatible with lead-free solders

Wound Ferrite

Overview of the SLF Series



FEATURES

- Magnetic shield type wound inductor for power circuits.
- Product lineup allows for various usages.

APPLICATION

Thin-screen TV, LCDs, AV equipment, gaming equipment, other electrical devices

PART NUMBER CONSTRUCTION

SLF	6025	T	-	4R7	M	1R5	-	PF			
Series name	LxWxH Dimensions (mm)		Packaging style		Inductance (μH)		Inductance tolerance		Rated current (A)		Internal code
6025	6.0x6.0x2.5		T	Taping	1R0	1.0	M	±20%	R47	0.47	
6028	6.0x6.0x2.8				100	10	N	±30%	2R2	2.2	
6045	6.0x6.0x4.5				101	100			150	15	
7032	7.0x7.0x3.2										
7045	7.0x7.0x4.5										
7055	7.0x7.0x5.5										
10145	10.1x10.1x4.5										
10165	10.1x10.1x6.8										
12555	12.5x12.5x5.5										
12565	12.5x12.5x6.5										
12575	12.5x12.5x7.5										

OPERATING TEMPERATURE RANGE, PACKAGE QUANTITY, PRODUCT WEIGHT

Type	Temperature range		Package quantity (pieces/reel)	Individual weight (g)
	Operating temperature*	Storage temperature**		
	(°C)	(°C)		
SLF6025	-40 to +105	-40 to +105	1000	0.3
SLF6028	-40 to +105	-40 to +105	1000	0.3
SLF6045	-40 to +105	-40 to +105	1000	0.4
SLF7032	-40 to +105	-40 to +105	1000	0.4
SLF7045	-40 to +105	-40 to +105	1000	0.6
SLF7055	-40 to +105	-40 to +105	1000	0.8
SLF10145	-40 to +105	-40 to +105	500	1.3
SLF10165	-40 to +105	-40 to +105	500	1.9
SLF12555	-40 to +105	-40 to +105	500	2.6
SLF12565	-40 to +105	-40 to +105	500	3.2
SLF12575	-40 to +105	-40 to +105	500	3.6

* Operating temperature range includes self-temperature rise.

** The Storage temperature range is for after the circuit board is mounted.

○ RoHS Directive Compliant Product: See the following for more details related to RoHS Directive compliant products. <http://www.tdk.co.jp/rohs/>

• All specifications are subject to change without notice.

Overview of the SLF Series

RECOMMENDED REFLOW PROFILE

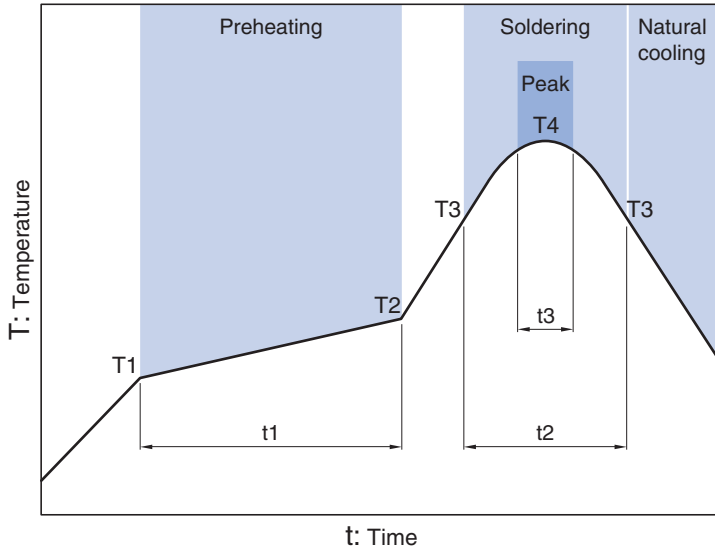

Preheating			Soldering		Peak	
Temp.	Temp.	Time	Temp.	Time	Temp.	Time
T1	T2	t1	T3	t2	T4	t3
150°C	180°C	60 to 120s	230°C	30s	250°C	5s

• All specifications are subject to change without notice.

SLF series

SLF6025 Type

SHAPE & DIMENSIONS

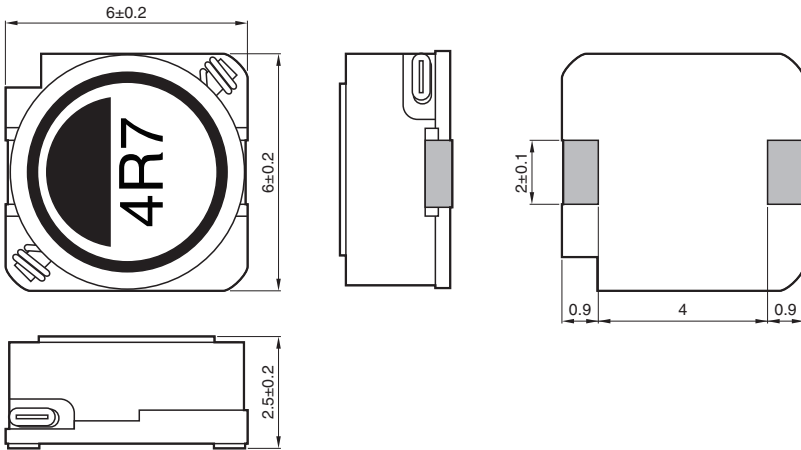

Dimensions in mm

RECOMMENDED LAND PATTERN

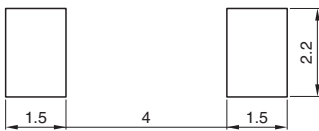

Dimensions in mm

SLF series SLF6025 Type

■ ELECTRICAL CHARACTERISTICS

□ CHARACTERISTICS SPECIFICATION TABLE

L (μ H)	Tolerance	L measuring frequency (kHz)	DC resistance (Ω) \pm 20%	Rated current(A)*		Part No.
				max. Idc1	Idc2	
4.7	\pm 20%	100	0.0306	1.5	1.8	SLF6025T-4R7M1R5-PF
6.8	\pm 20%	100	0.0442	1.3	1.5	SLF6025T-6R8M1R3-PF
10	\pm 20%	100	0.0573	1	1.3	SLF6025T-100M1R0-PF
15	\pm 20%	100	0.085	0.88	1.1	SLF6025T-150MR88-PF
22	\pm 20%	100	0.122	0.73	0.94	SLF6025T-220MR73-PF
33	\pm 20%	100	0.18	0.59	0.79	SLF6025T-330MR59-PF
47	\pm 20%	100	0.24	0.48	0.67	SLF6025T-470MR48-PF
68	\pm 20%	100	0.37	0.42	0.54	SLF6025T-680MR42-PF
100	\pm 20%	100	0.5	0.33	0.47	SLF6025T-101MR33-PF

* Rated current: smaller value of either Idc1 or Idc2.

Idc1: When based on the inductance change rate (30% below the nominal value)

Idc2: When based on the temperature increase (Temperature increase of 25°C by self heating)

○ Measurement equipment

Measurement item	Product No.	Manufacturer
L	4194A	Agilent Technologies
DC resistance	VP-2941A	Panasonic
Rated current Idc1	4284A+42841A+42842C	Agilent Technologies

* Equivalent measurement equipment may be used.

SLF series SLF6025 Type

ELECTRICAL CHARACTERISTICS

L FREQUENCY CHARACTERISTICS GRAPH



○ Measurement equipment

Product No.	Manufacturer
4294A	Agilent Technologies

* Equivalent measurement equipment may be used.

SLF series **SLF6025 Type**

■ ELECTRICAL CHARACTERISTICS

□ INDUCTANCE VS. DC BIAS CHARACTERISTICS GRAPH



○ Measurement equipment

Product No.	Manufacturer
4284A+42841A+42842C	Agilent Technologies

* Equivalent measurement equipment may be used.

SLF series

SLF6028 Type

SHAPE & DIMENSIONS



Dimensions in mm

RECOMMENDED LAND PATTERN



Dimensions in mm

SLF series **SLF6028 Type**

■ ELECTRICAL CHARACTERISTICS

□ CHARACTERISTICS SPECIFICATION TABLE

L (μ H)	tolerance	L measuring frequency (kHz)	DC resistance (Ω) \pm 20%	Rated current(A)*		Part No.
				max. Idc1	Idc2	
4.7	\pm 20%	100	0.0284	1.6	2.5	SLF6028T-4R7M1R6-PF
6.8	\pm 20%	100	0.0354	1.5	2.2	SLF6028T-6R8M1R5-PF
10	\pm 20%	100	0.0532	1.3	1.8	SLF6028T-100M1R3-PF
15	\pm 20%	100	0.0745	1	1.4	SLF6028T-150M1R0-PF
22	\pm 20%	100	0.104	0.77	1.3	SLF6028T-220MR77-PF
33	\pm 20%	100	0.148	0.69	1.1	SLF6028T-330MR69-PF
47	\pm 20%	100	0.21	0.59	0.92	SLF6028T-470MR59-PF
68	\pm 20%	100	0.29	0.5	0.78	SLF6028T-680MR50-PF
100	\pm 20%	100	0.43	0.42	0.64	SLF6028T-101MR42-PF
150	\pm 20%	100	0.65	0.34	0.5	SLF6028T-151MR34-PF
220	\pm 20%	100	0.98	0.26	0.38	SLF6028T-221MR26-PF

* Rated current: smaller value of either Idc1 or Idc2.

Idc1: When based on the inductance change rate (30% below the nominal value)

Idc2: When based on the temperature increase (Temperature increase of 25°C by self heating)

○ Measurement equipment

Measurement item	Product No.	Manufacturer
L	4194A	Agilent Technologies
DC resistance	VP-2941A	Panasonic
Rated current Idc1	4284A+42841A+42842C	Agilent Technologies

* Equivalent measurement equipment may be used.

SLF series SLF6028 Type

ELECTRICAL CHARACTERISTICS

L FREQUENCY CHARACTERISTICS GRAPH



○ Measurement equipment

Product No.	Manufacturer
4294A	Agilent Technologies

* Equivalent measurement equipment may be used.

SLF series SLF6028 Type

ELECTRICAL CHARACTERISTICS

INDUCTANCE VS. DC BIAS CHARACTERISTICS GRAPH



○ Measurement equipment

Product No.	Manufacturer
4284A+42841A+42842C	Agilent Technologies

* Equivalent measurement equipment may be used.

SLF series

SLF6045 Type

SHAPE & DIMENSIONS



Dimensions in mm

RECOMMENDED LAND PATTERN



Dimensions in mm

SLF series **SLF6045 Type**

■ ELECTRICAL CHARACTERISTICS

□ CHARACTERISTICS SPECIFICATION TABLE

L (μ H)	Tolerance	L measuring frequency (kHz)	DC resistance ($m\Omega$)	Rated current(A)*		Part No.
				max. Idc1	Idc2	
1.5	$\pm 30\%$	100	16 $\pm 30\%$	4	4.1	SLF6045T-1R5N4R0-3PF
2.2	$\pm 30\%$	100	18 $\pm 30\%$	3.3	3.8	SLF6045T-2R2N3R3-3PF
3.3	$\pm 30\%$	100	21.5 $\pm 30\%$	2.8	3.4	SLF6045T-3R3N2R8-3PF
4.7	$\pm 30\%$	100	26.5 $\pm 30\%$	2.4	3.2	SLF6045T-4R7N2R4-3PF
6.8	$\pm 30\%$	100	33 $\pm 30\%$	2	2.8	SLF6045T-6R8N2R0-3PF
10	$\pm 20\%$	100	39 $\pm 20\%$	1.6	2.7	SLF6045T-100M1R6-3PF
15	$\pm 20\%$	100	59.5 $\pm 20\%$	1.3	2.2	SLF6045T-150M1R3-3PF
22	$\pm 20\%$	100	82 $\pm 20\%$	1.1	1.8	SLF6045T-220M1R1-3PF

* Rated current: smaller value of either Idc1 or Idc2.

Idc1: When based on the inductance change rate (10% below the initial value)

Idc2: When based on the temperature increase (Temperature increase of 30°C by self heating)

○ Measurement equipment

Measurement item	Product No.	Manufacturer
L	4194A	Agilent Technologies
DC resistance	VP-2941A	Panasonic
Rated current Idc1	4284A+42841A+42842C	Agilent Technologies

* Equivalent measurement equipment may be used.

SLF series SLF6045 Type

ELECTRICAL CHARACTERISTICS

L FREQUENCY CHARACTERISTICS GRAPH

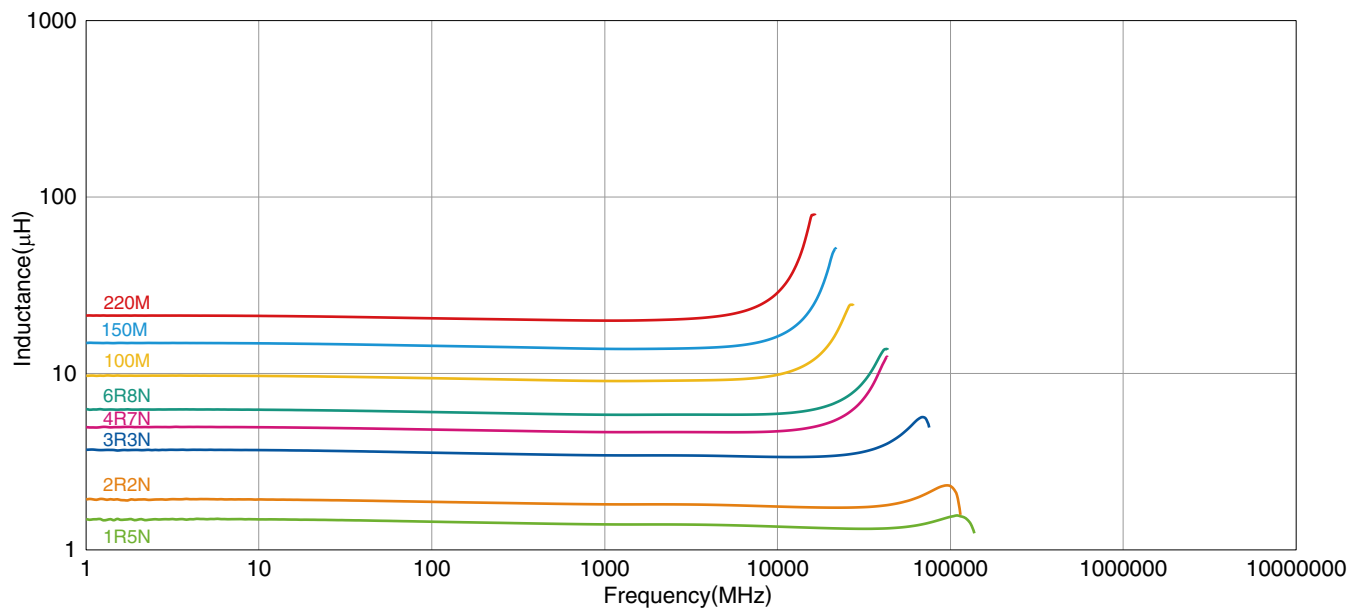

○ Measurement equipment

Product No.	Manufacturer
4294A	Agilent Technologies

* Equivalent measurement equipment may be used.

SLF series SLF6045 Type

ELECTRICAL CHARACTERISTICS

INDUCTANCE VS. DC BIAS CHARACTERISTICS GRAPH

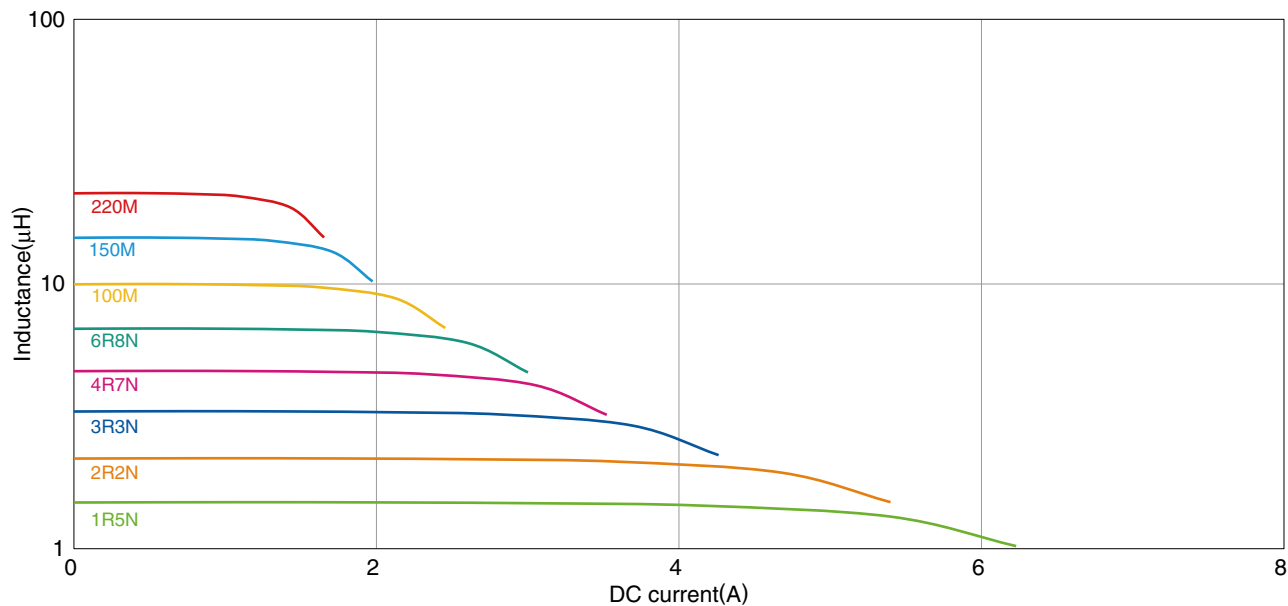

○ Measurement equipment

Product No.	Manufacturer
4284A+42841A+42842C	Agilent Technologies

* Equivalent measurement equipment may be used.

SLF series

SLF7032 Type

SHAPE & DIMENSIONS



Dimensions in mm

RECOMMENDED LAND PATTERN



Dimensions in mm

SLF series SLF7032 Type

■ ELECTRICAL CHARACTERISTICS

□ CHARACTERISTICS SPECIFICATION TABLE

L (μH)	Tolerance	L measuring frequency (kHz)	DC resistance (Ω) $\pm 20\%$	Rated current(A) max.	Part No.
3.3	$\pm 20\%$	100	0.023	1.9	SLF7032T-3R3M1R9-2PF
4.7	$\pm 20\%$	100	0.030	1.7	SLF7032T-4R7M1R7-2PF
6.8	$\pm 20\%$	100	0.041	1.6	SLF7032T-6R8M1R6-2PF
10	$\pm 20\%$	100	0.053	1.4	SLF7032T-100M1R4-2PF
15	$\pm 20\%$	100	0.075	1.1	SLF7032T-150M1R1-2PF
22	$\pm 20\%$	100	0.11	0.96	SLF7032T-220MR96-2PF
33	$\pm 20\%$	100	0.16	0.75	SLF7032T-330MR75-2PF
47	$\pm 20\%$	100	0.24	0.67	SLF7032T-470MR67-2PF
68	$\pm 20\%$	100	0.31	0.59	SLF7032T-680MR59-2PF
100	$\pm 20\%$	100	0.45	0.45	SLF7032T-101MR45-2PF
150	$\pm 20\%$	100	0.65	0.37	SLF7032T-151MR37-2PF
220	$\pm 20\%$	100	1.05	0.29	SLF7032T-221MR29-2PF
330	$\pm 20\%$	100	1.67	0.22	SLF7032T-331MR22-2PF
470	$\pm 20\%$	100	2.05	0.2	SLF7032T-471MR20-2PF
680	$\pm 20\%$	100	3.15	0.16	SLF7032T-681MR16-2PF
1000	$\pm 20\%$	100	4.78	0.13	SLF7032T-102MR13-2PF

○ Measurement equipment

Measurement item	Product No.	Manufacturer
L	4194A	Agilent Technologies
DC resistance	VP-2941A	Panasonic
Rated current I _{dc1}	4284A+42841A+42842C	Agilent Technologies

* Equivalent measurement equipment may be used.

SLF series SLF7032 Type

ELECTRICAL CHARACTERISTICS

FREQUENCY CHARACTERISTICS GRAPH

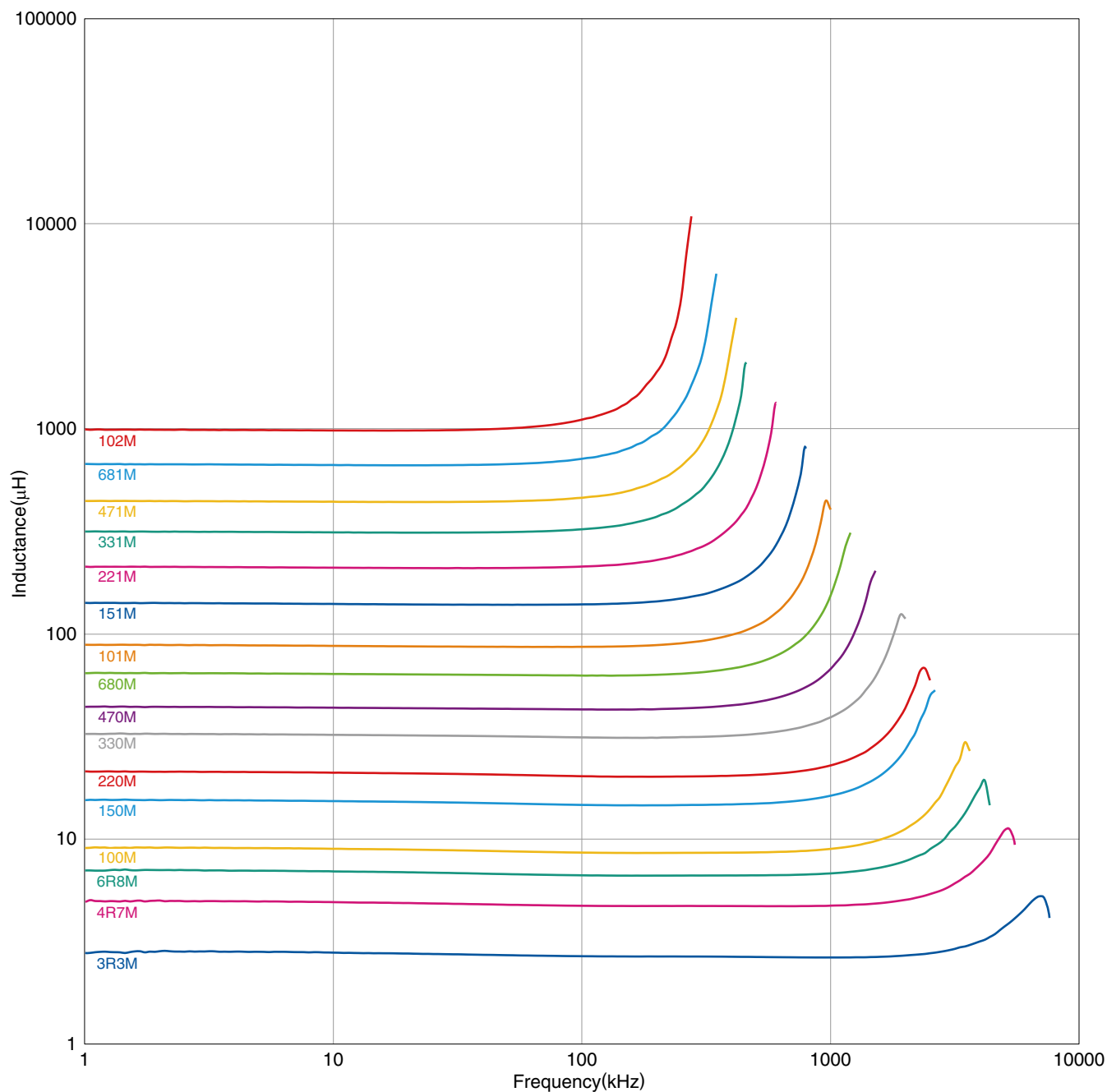

○ Measurement equipment

Product No.	Manufacturer
4294A	Agilent Technologies

* Equivalent measurement equipment may be used.

SLF series SLF7032 Type

ELECTRICAL CHARACTERISTICS

INDUCTANCE VS. DC BIAS CHARACTERISTICS GRAPH



○ Measurement equipment

Product No.	Manufacturer
4284A+42841A+42842C	Agilent Technologies

* Equivalent measurement equipment may be used.

SLF series

SLF7045 Type

■ SHAPE & DIMENSIONS



Dimensions in mm

■ RECOMMENDED LAND PATTERN

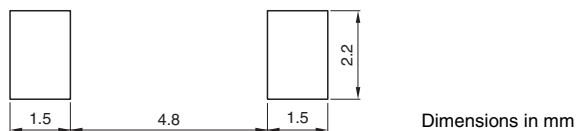

Dimensions in mm

SLF series SLF7045 Type

■ ELECTRICAL CHARACTERISTICS

□ CHARACTERISTICS SPECIFICATION TABLE

L (μ H)	Tolerance	L measuring frequency (kHz)	DC resistance (Ω) \pm 20%	Rated current(A)*		Part No.
				max. Idc1	Idc2	
3.3	\pm 20%	100	0.02	2.5	2.3	SLF7045T-3R3M2R5-PF
4.7	\pm 20%	100	0.03	2	2.1	SLF7045T-4R7M2R0-PF
6.8	\pm 20%	100	0.039	1.7	1.74	SLF7045T-6R8M1R7-PF
10	\pm 20%	100	0.036	1.3	1.78	SLF7045T-100M1R3-PF
15	\pm 20%	100	0.052	1.1	1.53	SLF7045T-150M1R1-PF
22	\pm 20%	100	0.061	0.9	1.34	SLF7045T-220MR90-PF
33	\pm 20%	100	0.096	0.82	1.09	SLF7045T-330MR82-PF
47	\pm 20%	100	0.125	0.75	0.92	SLF7045T-470MR75-PF
68	\pm 20%	100	0.175	0.6	0.77	SLF7045T-680MR60-PF
100	\pm 20%	100	0.25	0.5	0.65	SLF7045T-101MR50-PF
150	\pm 20%	100	0.34	0.4	0.55	SLF7045T-151MR40-PF
220	\pm 20%	100	0.52	0.33	0.45	SLF7045T-221MR33-PF
330	\pm 20%	100	0.74	0.25	0.37	SLF7045T-331MR25-PF
470	\pm 20%	100	1.05	0.22	0.31	SLF7045T-471MR22-PF
680	\pm 20%	100	1.48	0.2	0.27	SLF7045T-681MR20-PF
1000	\pm 20%	100	2.28	0.14	0.25	SLF7045T-102MR14-PF

* Rated current: smaller value of either Idc1 or Idc2.

Idc1: When based on the inductance change rate (10% below the initial value)

Idc2: When based on the temperature increase (Temperature increase of 20°C by self heating)

○ Measurement equipment

Measurement item	Product No.	Manufacturer
L	4194A	Agilent Technologies
DC resistance	VP-2941A	Panasonic
Rated current Idc1	4284A+42841A+42842C	Agilent Technologies

* Equivalent measurement equipment may be used.

SLF series SLF7045 Type

ELECTRICAL CHARACTERISTICS

L FREQUENCY CHARACTERISTICS GRAPH



○ Measurement equipment

Product No.	Manufacturer
4294A	Agilent Technologies

* Equivalent measurement equipment may be used.

SLF series SLF7045 Type

ELECTRICAL CHARACTERISTICS

INDUCTANCE VS. DC BIAS CHARACTERISTICS GRAPH

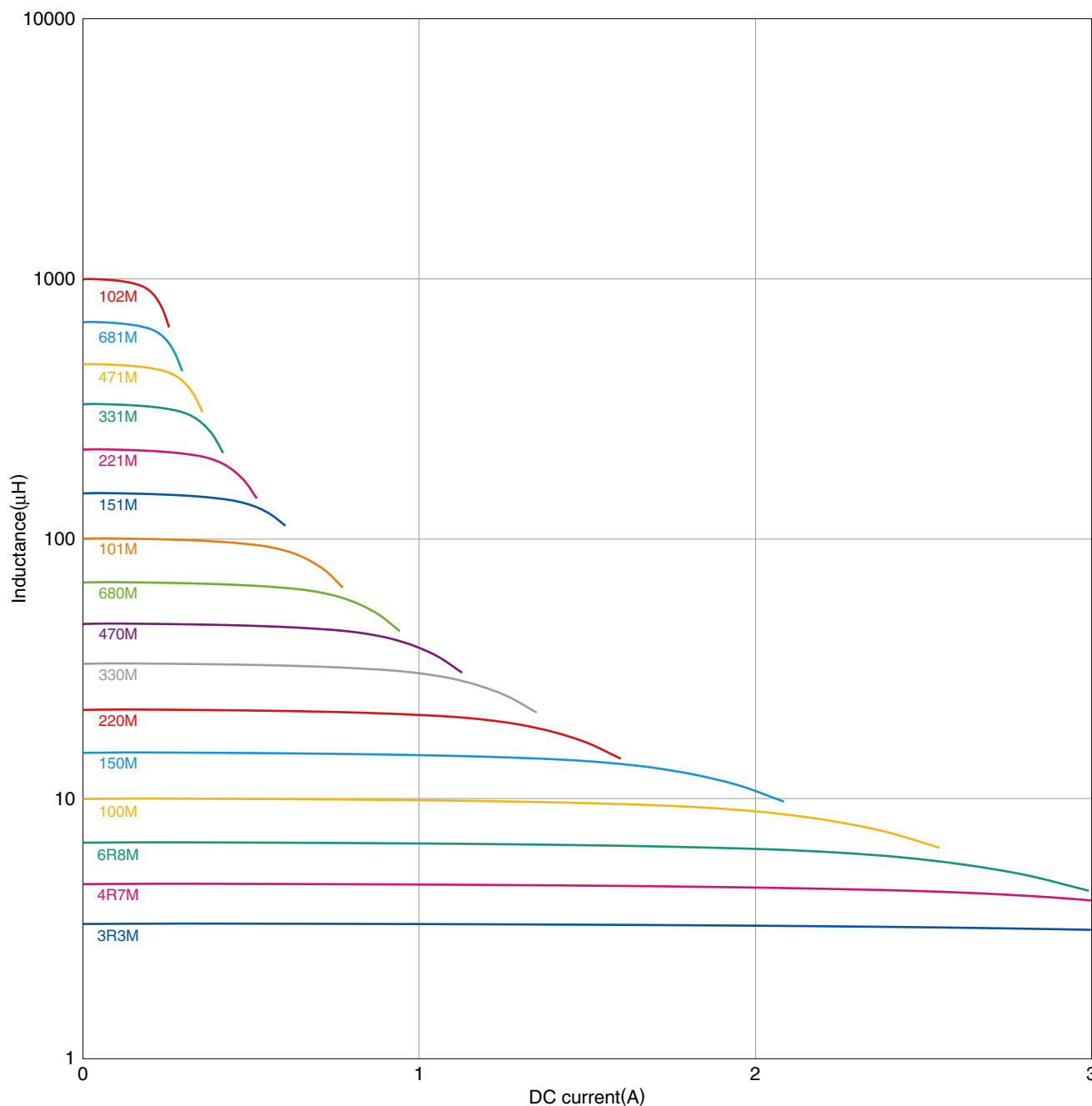

○ Measurement equipment

Product No.	Manufacturer
4284A+42841A+42842C	Agilent Technologies

* Equivalent measurement equipment may be used.

SLF series

SLF7055 Type

SHAPE & DIMENSIONS



Dimensions in mm

RECOMMENDED LAND PATTERN



Dimensions in mm

SLF series **SLF7055 Type**

■ ELECTRICAL CHARACTERISTICS

□ CHARACTERISTICS SPECIFICATION TABLE

L (μ H)	Tolerance	L measuring frequency (kHz)	DC resistance ($m\Omega$)	Rated current(A)* max.		Part No.
				Idc1	Idc2	
1.5	$\pm 30\%$	100	17.4 $\pm 30\%$	6.2	4	SLF7055T-1R5N4R0-3PF
2.2	$\pm 30\%$	100	21.7 $\pm 30\%$	5.3	3.5	SLF7055T-2R2N3R5-3PF
3.3	$\pm 30\%$	100	24 $\pm 30\%$	4.3	3.3	SLF7055T-3R3N3R3-3PF
4.7	$\pm 30\%$	100	28 $\pm 30\%$	3.6	3.1	SLF7055T-4R7N3R1-3PF
6.8	$\pm 30\%$	100	34 $\pm 30\%$	3	2.8	SLF7055T-6R8N2R8-3PF
10	$\pm 20\%$	100	39.1 $\pm 20\%$	2.6	2.5	SLF7055T-100M2R5-3PF
15	$\pm 20\%$	100	50.8 $\pm 20\%$	2.1	2.2	SLF7055T-150M2R1-3PF
22	$\pm 20\%$	100	64.3 $\pm 20\%$	1.7	2	SLF7055T-220M1R7-3PF

* Rated current: smaller value of either Idc1 or Idc2.

Idc1: When based on the inductance change rate (10% below the initial value)

Idc2: When based on the temperature increase (Temperature increase of 30°C by self heating)

○ Measurement equipment

Measurement item	Product No.	Manufacturer
L	4194A	Agilent Technologies
DC resistance	VP-2941A	Panasonic
Rated current Idc1	4284A+42841A+42842C	Agilent Technologies

* Equivalent measurement equipment may be used.

SLF series SLF7055 Type

ELECTRICAL CHARACTERISTICS

L FREQUENCY CHARACTERISTICS GRAPH



○ Measurement equipment

Product No.	Manufacturer
4294A	Agilent Technologies

* Equivalent measurement equipment may be used.

SLF series **SLF7055 Type**

■ ELECTRICAL CHARACTERISTICS

□ INDUCTANCE VS. DC BIAS CHARACTERISTICS GRAPH

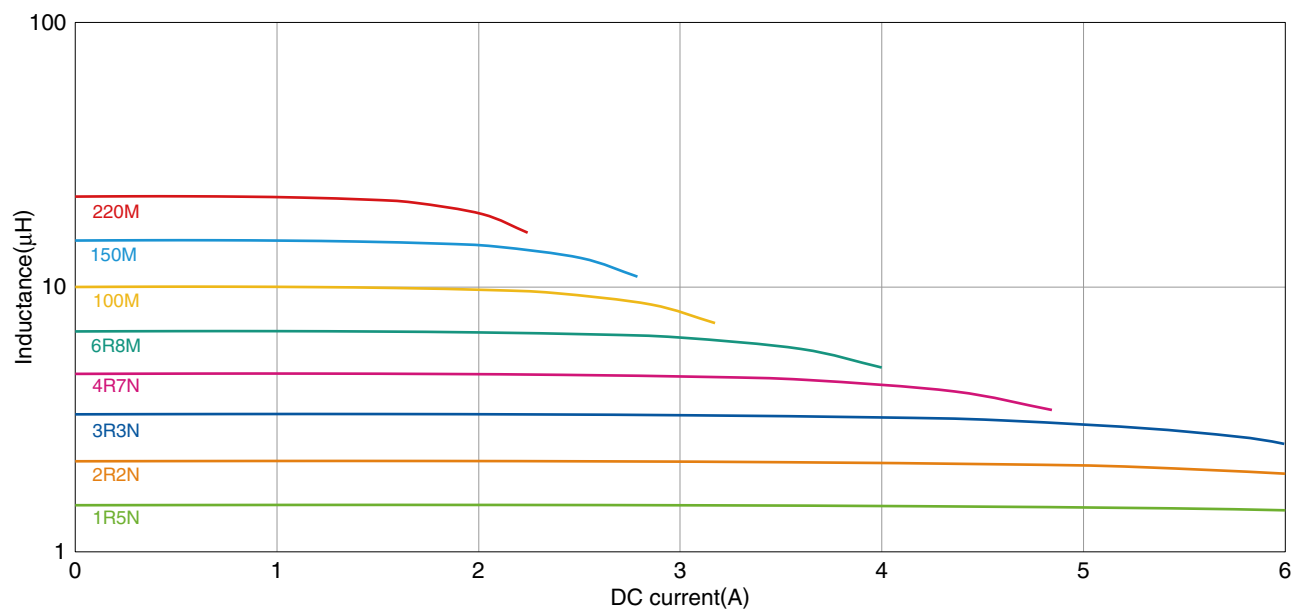

○ Measurement equipment

Product No.	Manufacturer
4284A+42841A+42842C	Agilent Technologies

* Equivalent measurement equipment may be used.

SLF series

SLF10145 Type

SHAPE & DIMENSIONS



Dimensions in mm

RECOMMENDED LAND PATTERN



Dimensions in mm

SLF series **SLF10145 Type**

■ ELECTRICAL CHARACTERISTICS

□ CHARACTERISTICS SPECIFICATION TABLE

L (μH)	Tolerance	L measuring frequency (kHz)	DC resistance (Ω)±20%	Rated current(A)*		Part No.
				max. Idc1	Idc2	
3.3	±30%	1	0.0161	4.9	3.7	SLF10145T-3R3N3R7-PF
5.6	±20%	1	0.0220	3.8	3.2	SLF10145T-5R6M3R2-PF
10	±20%	1	0.0364	3	2.5	SLF10145T-100M2R5-PF
15	±20%	1	0.0472	2.4	2.2	SLF10145T-150M2R2-PF
22	±20%	1	0.0591	2.1	1.9	SLF10145T-220M1R9-PF
33	±20%	1	0.0815	1.6	1.7	SLF10145T-330M1R6-PF
47	±20%	1	0.1	1.4	1.5	SLF10145T-470M1R4-PF
68	±20%	1	0.14	1.2	1.3	SLF10145T-680M1R2-PF
100	±20%	1	0.2	1	1.1	SLF10145T-101M1R0-PF
150	±20%	1	0.35	0.79	0.81	SLF10145T-151MR79-PF
220	±20%	1	0.47	0.65	0.7	SLF10145T-221MR65-PF
330	±20%	1	0.68	0.54	0.58	SLF10145T-331MR54-PF
470	±20%	1	1.03	0.47	0.47	SLF10145T-471MR47-PF
680	±20%	1	1.6	0.38	0.38	SLF10145T-681MR38-PF
1000	±20%	1	2.8	0.32	0.29	SLF10145T-102MR29-PF
1500	±20%	1	3.4	0.22	0.26	SLF10145T-152MR22-PF

* Rated current: smaller value of either Idc1 or Idc2.

Idc1: When based on the inductance change rate (10% below the initial value)

Idc2: When based on the temperature increase (Temperature increase of 30°C by self heating)

○ Measurement equipment

Measurement item	Product No.	Manufacturer
L	4194A	Agilent Technologies
DC resistance	VP-2941A	Panasonic
Rated current Idc1	4284A+42841A+42842C	Agilent Technologies

* Equivalent measurement equipment may be used.

SLF series SLF10145 Type

ELECTRICAL CHARACTERISTICS

FREQUENCY CHARACTERISTICS GRAPH



○ Measurement equipment

Product No.	Manufacturer
4294A	Agilent Technologies

* Equivalent measurement equipment may be used.

• All specifications are subject to change without notice.

SLF series SLF10145 Type

ELECTRICAL CHARACTERISTICS

INDUCTANCE VS. DC BIAS CHARACTERISTICS GRAPH

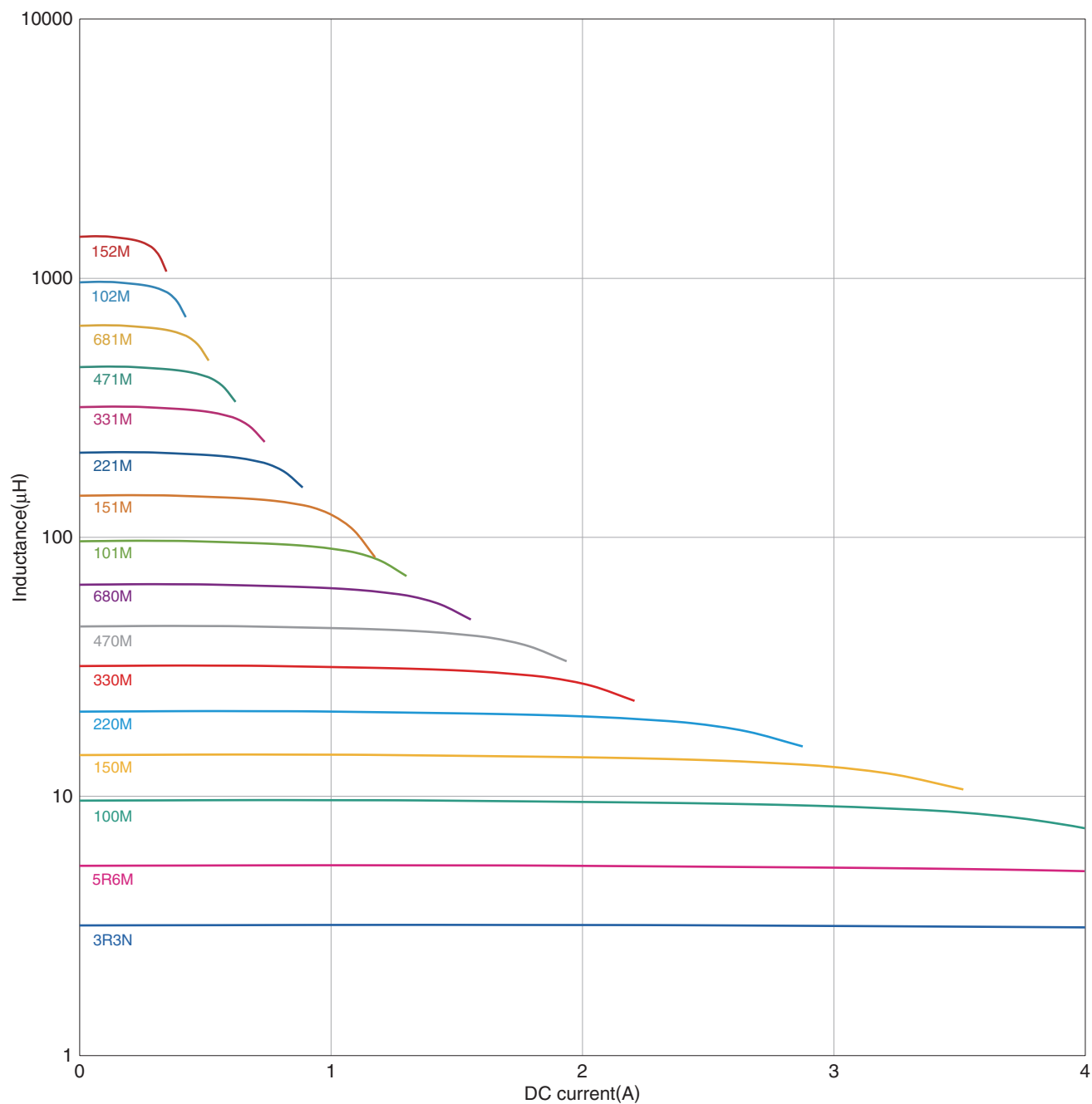

○ Measurement equipment

Product No.	Manufacturer
4284A+42841A+42842C	Agilent Technologies

* Equivalent measurement equipment may be used.

SLF series

SLF10165 Type

■ SHAPE & DIMENSIONS



Dimensions in mm

■ RECOMMENDED LAND PATTERN



Dimensions in mm

SLF series **SLF10165 Type**

■ ELECTRICAL CHARACTERISTICS

□ CHARACTERISTICS SPECIFICATION TABLE

L (μ H)	Tolerance	L measuring frequency (kHz)	DC resistance (m Ω)	Rated current(A)* max.		Part No.
				Idc1	Idc2	
1.5	$\pm 30\%$	100	6.7 $\pm 30\%$	10.7	6.8	SLF10165T-1R5N6R83PF
2.2	$\pm 30\%$	100	8.4 $\pm 30\%$	8.9	6.3	SLF10165T-2R2N6R33PF
3.3	$\pm 30\%$	100	9.6 $\pm 30\%$	7.8	5.8	SLF10165T-3R3N5R83PF
4.7	$\pm 30\%$	100	11.7 $\pm 30\%$	6.1	4.7	SLF10165T-4R7N4R73PF
6.8	$\pm 30\%$	100	14 $\pm 30\%$	4.6	4.3	SLF10165T-6R8N4R33PF
10	$\pm 20\%$	100	18.5 $\pm 20\%$	4.1	3.8	SLF10165T-100M3R83PF
15	$\pm 20\%$	100	27 $\pm 20\%$	3.1	3.1	SLF10165T-150M3R13PF
22	$\pm 20\%$	100	44.8 $\pm 20\%$	2.7	2.4	SLF10165T-220M2R43PF

* Rated current: smaller value of either Idc1 or Idc2.

Idc1: When based on the inductance change rate (10% below the initial value)

Idc2: When based on the temperature increase (Temperature increase of 30°C by self heating)

○ Measurement equipment

Measurement item	Product No.	Manufacturer
L	4194A	Agilent Technologies
DC resistance	VP-2941A	Panasonic
Rated current Idc1	4284A+42841A+42842C	Agilent Technologies

* Equivalent measurement equipment may be used.

SLF series SLF10165 Type

ELECTRICAL CHARACTERISTICS

L FREQUENCY CHARACTERISTICS GRAPH



○ Measurement equipment

Product No.	Manufacturer
4294A	Agilent Technologies

* Equivalent measurement equipment may be used.

SLF series SLF10165 Type

ELECTRICAL CHARACTERISTICS

INDUCTANCE VS. DC BIAS CHARACTERISTICS GRAPH

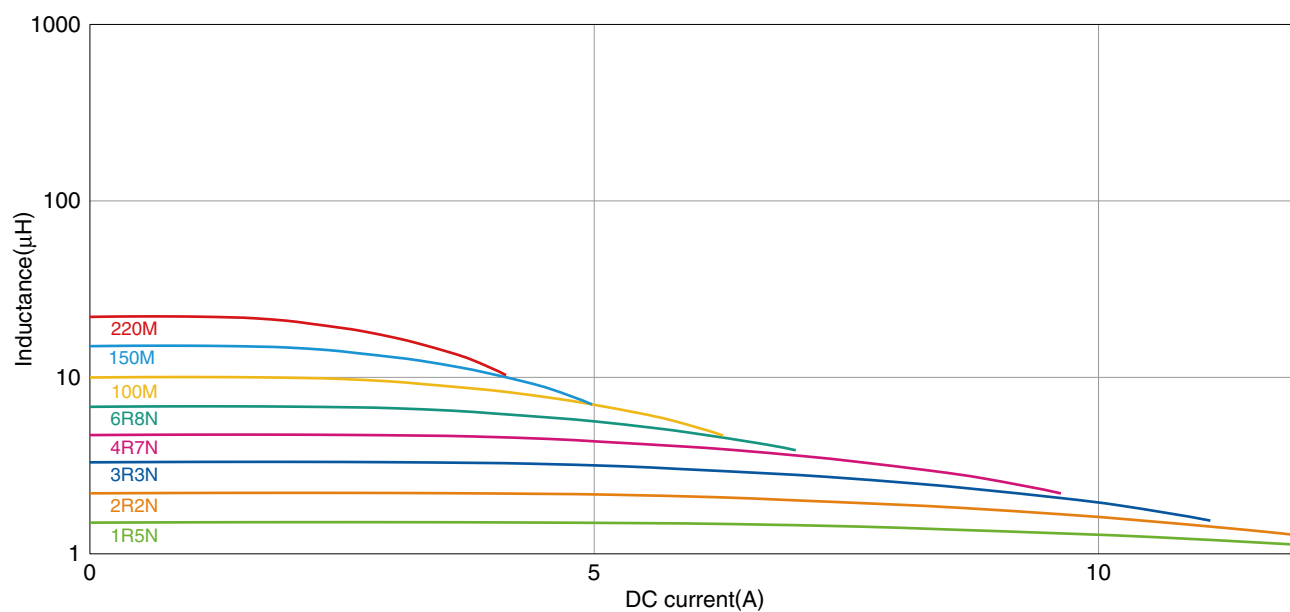

○ Measurement equipment

Product No.	Manufacturer
4284A+42841A+42842C	Agilent Technologies

* Equivalent measurement equipment may be used.

SLF series

SLF12555 Type

SHAPE & DIMENSIONS

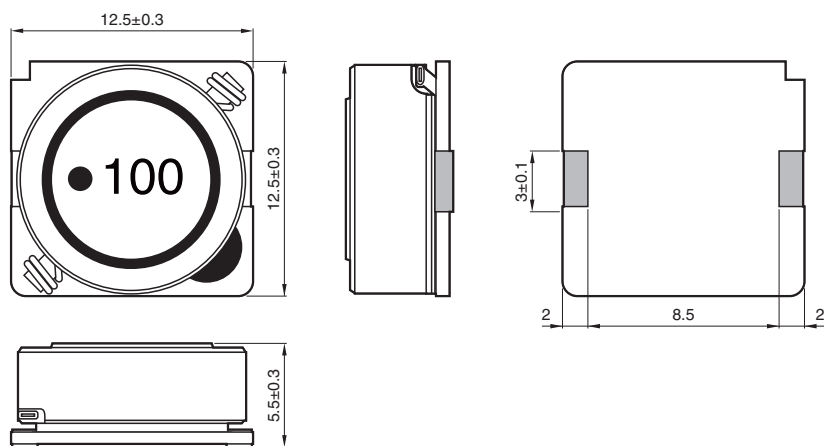

Dimensions in mm

RECOMMENDED LAND PATTERN

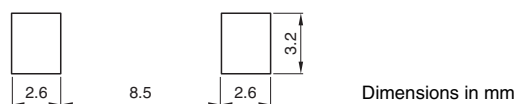

Dimensions in mm

SLF series **SLF12555 Type**

■ ELECTRICAL CHARACTERISTICS

□ CHARACTERISTICS SPECIFICATION TABLE

L (μ H)	Tolerance	L measuring frequency (kHz)	DC resistance (Ω) \pm 20%	Rated current(A)*		Part No.
				max. Idc1	Idc2	
6	\pm 30%	1	0.0164	3.6	4.9	SLF12555T-6R0N3R6-PF
10	\pm 20%	1	0.0215	3.4	4.3	SLF12555T-100M3R4-PF
15	\pm 20%	1	0.0259	2.8	3.9	SLF12555T-150M2R8-PF
22	\pm 20%	1	0.0338	2.3	3.4	SLF12555T-220M2R3-PF
33	\pm 20%	1	0.0415	1.9	3.1	SLF12555T-330M1R9-PF
47	\pm 20%	1	0.0618	1.6	2.5	SLF12555T-470M1R6-PF
68	\pm 20%	1	0.0832	1.3	2.2	SLF12555T-680M1R3-PF
100	\pm 20%	1	0.117	1.1	1.8	SLF12555T-101M1R1-PF
150	\pm 20%	1	0.19	0.88	1.4	SLF12555T-151MR88-PF
220	\pm 20%	1	0.27	0.72	1.2	SLF12555T-221MR72-PF
330	\pm 20%	1	0.41	0.59	1	SLF12555T-331MR59-PF
470	\pm 20%	1	0.52	0.49	0.88	SLF12555T-471MR49-PF
680	\pm 20%	1	0.76	0.43	0.73	SLF12555T-681MR43-PF
1000	\pm 20%	1	1.12	0.34	0.6	SLF12555T-102MR34-PF
1500	\pm 20%	1	1.73	0.29	0.48	SLF12555T-152MR29-PF

* Rated current: smaller value of either Idc1 or Idc2.

Idc1: When based on the inductance change rate (10% below the initial value)

Idc2: When based on the temperature increase (Temperature increase of 30°C by self heating)

○ Measurement equipment

Measurement item	Product No.	Manufacturer
L	4194A	Agilent Technologies
DC resistance	VP-2941A	Panasonic
Rated current Idc1	4284A+42841A+42842C	Agilent Technologies

* Equivalent measurement equipment may be used.

SLF series SLF12555 Type

ELECTRICAL CHARACTERISTICS

L FREQUENCY CHARACTERISTICS GRAPH



○ Measurement equipment

Product No.	Manufacturer
4294A	Agilent Technologies

* Equivalent measurement equipment may be used.

SLF series SLF12555 Type

ELECTRICAL CHARACTERISTICS

INDUCTANCE VS. DC BIAS CHARACTERISTICS GRAPH



○ Measurement equipment

Product No.	Manufacturer
4284A+42841A+42842C	Agilent Technologies

* Equivalent measurement equipment may be used.

SLF series

SLF12565 Type

SHAPE & DIMENSIONS



Dimensions in mm

RECOMMENDED LAND PATTERN



Dimensions in mm

SLF series **SLF12565 Type**

■ ELECTRICAL CHARACTERISTICS

□ CHARACTERISTICS SPECIFICATION TABLE

L (μ H)	Tolerance	L measuring frequency (kHz)	DC resistance (Ω) \pm 20%	Rated current(A)*		Part No.
				max. Idc1	Idc2	
2	\pm 30%	1	0.0117	10	6.2	SLF12565T-2R0N6R2-PF
4.2	\pm 30%	1	0.015	7.3	5.5	SLF12565T-4R2N5R5-PF
7	\pm 30%	1	0.0177	5.7	5	SLF12565T-7R0N5R0-PF
10	\pm 20%	1	0.0202	5	4.8	SLF12565T-100M4R8-PF
15	\pm 20%	1	0.0237	4.2	4.4	SLF12565T-150M4R2-PF
22	\pm 20%	1	0.0316	3.5	3.8	SLF12565T-220M3R5-PF
33	\pm 20%	1	0.0406	2.8	3.4	SLF12565T-330M2R8-PF
47	\pm 20%	1	0.0578	2.4	2.8	SLF12565T-470M2R4-PF
68	\pm 20%	1	0.0787	2	2.4	SLF12565T-680M2R0-PF
100	\pm 20%	1	0.123	1.6	1.9	SLF12565T-101M1R6-PF
220	\pm 20%	1	0.273	1	1.2	SLF12565T-221M1R0-PF

* Rated current: smaller value of either Idc1 or Idc2.

Idc1: When based on the inductance change rate (10% below the initial value)

Idc2: When based on the temperature increase (Temperature increase of 40°C by self heating)

○ Measurement equipment

Measurement item	Product No.	Manufacturer
L	4194A	Agilent Technologies
DC resistance	VP-2941A	Panasonic
Rated current Idc1	4284A+42841A+42842C	Agilent Technologies

* Equivalent measurement equipment may be used.

SLF series SLF12565 Type

ELECTRICAL CHARACTERISTICS

L FREQUENCY CHARACTERISTICS GRAPH



○ Measurement equipment

Product No.	Manufacturer
4294A	Agilent Technologies

* Equivalent measurement equipment may be used.

SLF series **SLF12565 Type**

■ ELECTRICAL CHARACTERISTICS

□ INDUCTANCE VS. DC BIAS CHARACTERISTICS GRAPH

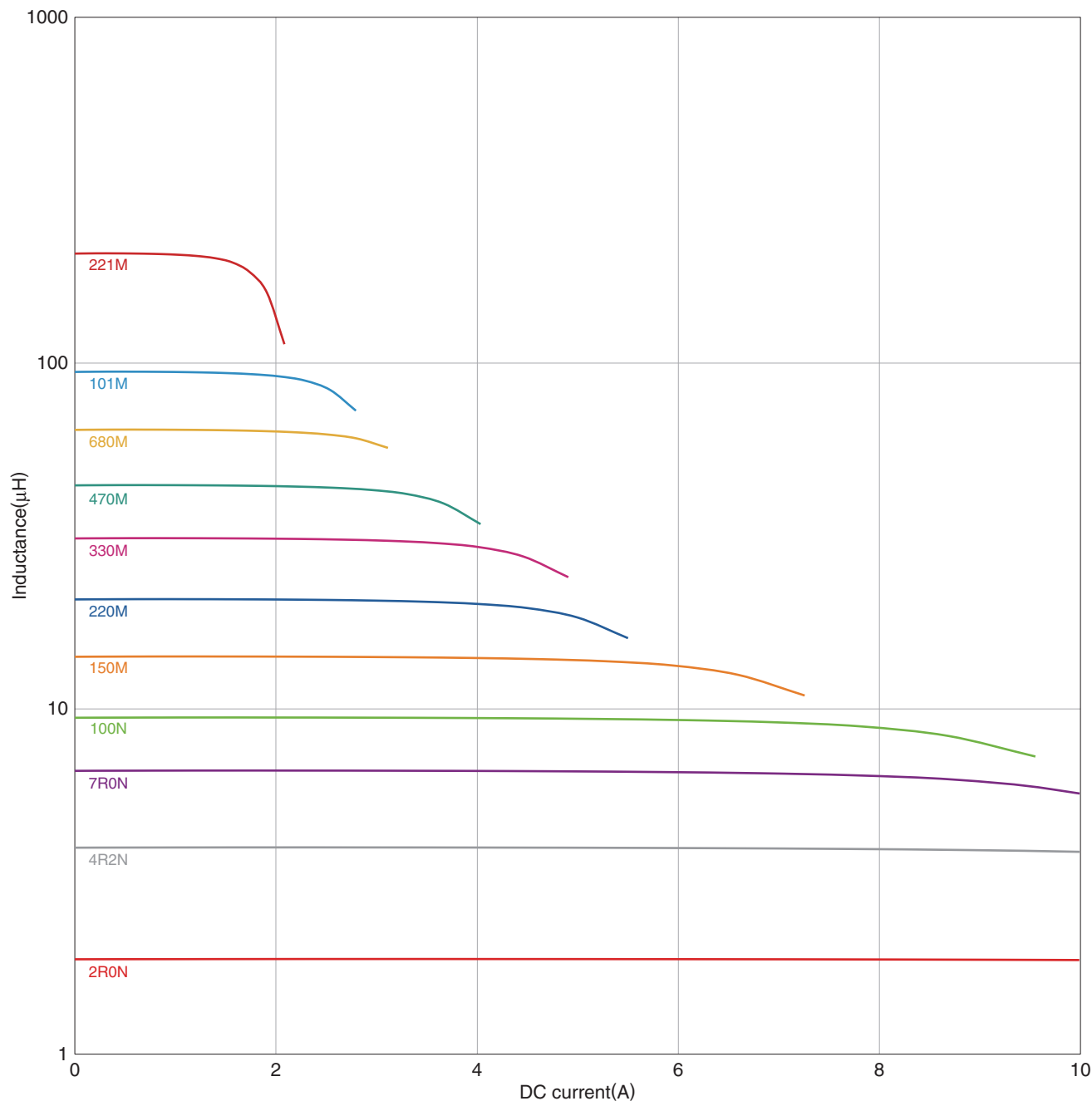

○ Measurement equipment

Product No.	Manufacturer
4284A+42841A+42842C	Agilent Technologies

* Equivalent measurement equipment may be used.

SLF series

SLF12575 Type

SHAPE & DIMENSIONS



Dimensions in mm

RECOMMENDED LAND PATTERN



Dimensions in mm

SLF series SLF12575 Type

■ ELECTRICAL CHARACTERISTICS

□ CHARACTERISTICS SPECIFICATION TABLE

L (μ H)	Tolerance	L measuring frequency (kHz)	DC resistance (Ω) \pm 20%	Rated current(A)* max.		Part No.
				Idc1	Idc2	
1.2	\pm 30%	1	0.0069	13	8.2	SLF12575T-1R2N8R2-PF
2.7	\pm 30%	1	0.0094	10	7	SLF12575T-2R7N7R0-PF
3.9	\pm 30%	1	0.0104	9	6.7	SLF12575T-3R9N6R7-PF
5.6	\pm 30%	1	0.0116	7.8	6.3	SLF12575T-5R6N6R3-PF
6.8	\pm 30%	1	0.0131	7.2	5.9	SLF12575T-6R8N5R9-PF
10	\pm 20%	1	0.0156	5.5	5.4	SLF12575T-100M5R4-PF
15	\pm 20%	1	0.0184	4.7	5	SLF12575T-150M4R7-PF
22	\pm 20%	1	0.0263	4	4	SLF12575T-220M4R0-PF
33	\pm 20%	1	0.0395	3.2	3.4	SLF12575T-330M3R2-PF
47	\pm 20%	1	0.0528	2.7	3	SLF12575T-470M2R7-PF
68	\pm 20%	1	0.0778	2	2.4	SLF12575T-680M2R0-PF
100	\pm 20%	1	0.125	1.9	1.9	SLF12575T-101M1R9-PF
150	\pm 20%	1	0.175	1.5	1.6	SLF12575T-151M1R5-PF
220	\pm 20%	1	0.258	1.3	1.3	SLF12575T-221M1R3-PF

* Rated current: smaller value of either Idc1 or Idc2.

Idc1: When based on the inductance change rate (10% below the initial value)

Idc2: When based on the temperature increase (Temperature increase of 40°C by self heating)

○ Measurement equipment

Measurement item	Product No.	Manufacturer
L	4194A	Agilent Technologies
DC resistance	VP-2941A	Panasonic
Rated current Idc1	4284A+42841A+42842C	Agilent Technologies

* Equivalent measurement equipment may be used.

SLF series SLF12575 Type

ELECTRICAL CHARACTERISTICS

L FREQUENCY CHARACTERISTICS GRAPH

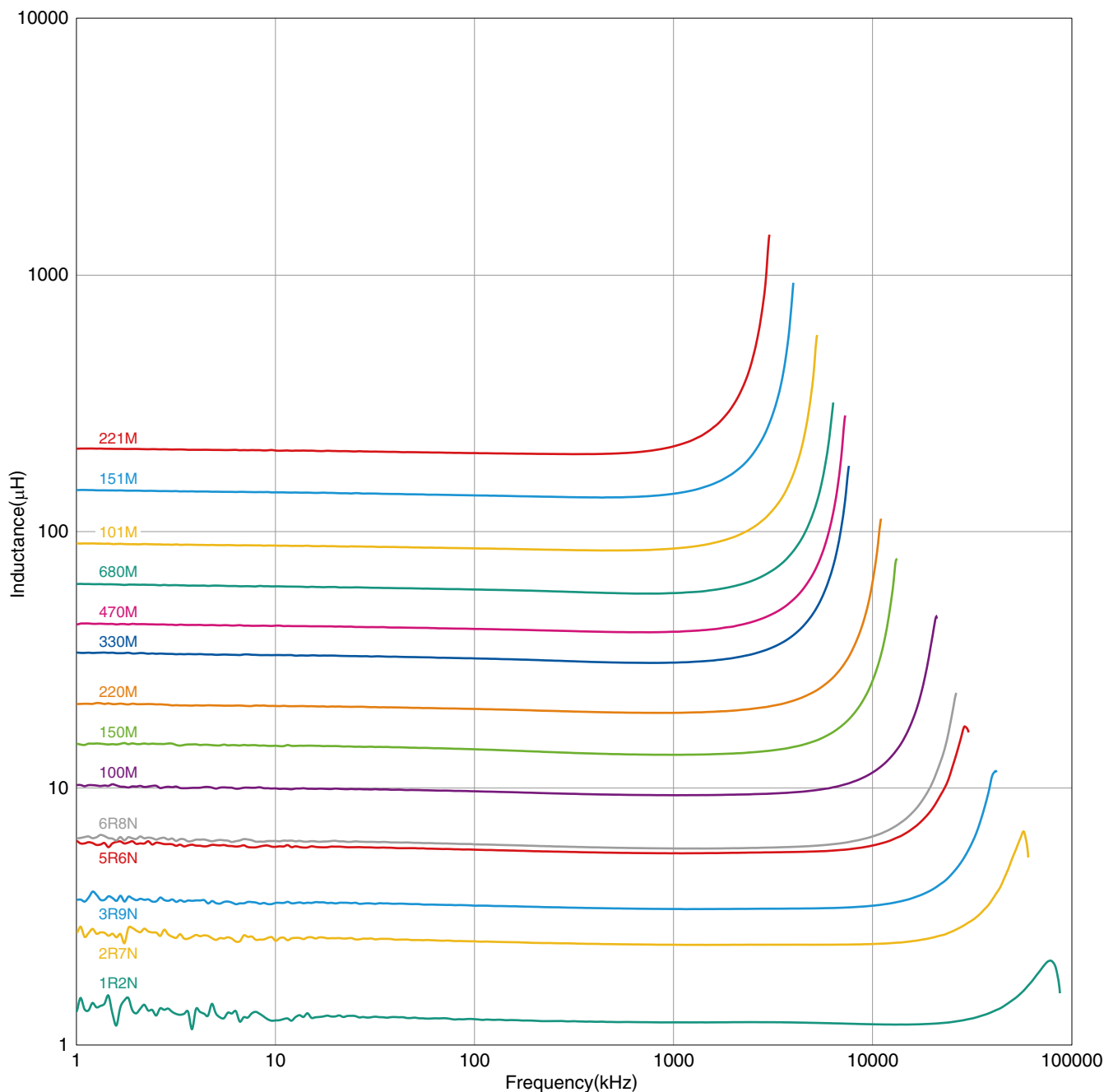

○ Measurement equipment

Product No.	Manufacturer
4294A	Agilent Technologies

* Equivalent measurement equipment may be used.

SLF series SLF12575 Type

ELECTRICAL CHARACTERISTICS

INDUCTANCE VS. DC BIAS CHARACTERISTICS GRAPH



○ Measurement equipment

Product No.	Manufacturer
4284A+42841A+42842C	Agilent Technologies

* Equivalent measurement equipment may be used.

SLF_{series}

Packaging Style

REEL DIMENSIONS



Type	A	B	C	D	E
SLF6025	ø330	22.4	ø50	16.4	2
SLF6028	ø330	22.4	ø50	16.4	2
SLF6045	ø330	22.4	ø50	16.4	2
SLF7032	ø330	22.4	ø50	16.4	2
SLF7045	ø330	22.4	ø50	16.4	2
SLF7055	ø330	22.4	ø50	16.4	2
SLF10145	ø330	30.4	ø50	24.4	2
SLF10165	ø330	30.4	ø50	24.4	2
SLF12555	ø330	30.4	ø50	24.4	2
SLF12565	ø330	30.4	ø50	24.4	2
SLF12575	ø330	30.4	ø50	24.4	2

* These values are typical values.

TAPE DIMENSIONS



Type	A0	B0	øD0	E	F	P0	P1	P2	W	K	t
SLF6025	6.4	6.4	1.5+0.1/-0	1.75±0.1	7.5±0.1	4.0±0.1	12.0±0.1	2.0±0.05	16.0±0.3	3.1	0.4
SLF6028	6.4	6.4	1.5+0.1/-0	1.75±0.1	7.5±0.1	4.0±0.1	12.0±0.1	2.0±0.05	16.0±0.3	3.1	0.4
SLF6045	6.4	6.4	1.5+0.1/-0	1.75±0.1	7.5±0.1	4.0±0.1	12.0±0.1	2.0±0.05	16.0±0.3	4.9	0.4
SLF7032	7.4	7.6	1.5+0.1/-0	1.75±0.1	7.5±0.1	4.0±0.1	12.0±0.1	2.0±0.05	16.0±0.3	3.6	0.4
SLF7045	7.4	7.6	1.5+0.1/-0	1.75±0.1	7.5±0.1	4.0±0.1	12.0±0.1	2.0±0.05	16.0±0.3	4.8	0.4
SLF7055	7.4	7.6	1.5+0.1/-0	1.75±0.1	7.5±0.1	4.0±0.1	12.0±0.1	2.0±0.05	16.0±0.3	5.5	0.4
SLF10145	10.5	10.5	1.5+0.1/-0	1.75±0.1	11.5±0.1	4.0±0.1	16.0±0.1	2.0±0.05	24.0±0.3	5.0	0.4
SLF10165	10.5	10.5	1.5+0.1/-0	1.75±0.1	11.5±0.1	4.0±0.1	16.0±0.1	2.0±0.05	24.0±0.3	7.1	0.4
SLF12555	13	13	1.5+0.1/-0	1.75±0.1	11.5±0.1	4.0±0.1	16.0±0.1	2.0±0.05	24.0±0.3	6.0	0.4
SLF12565	13	13	1.5+0.1/-0	1.75±0.1	11.5±0.1	4.0±0.1	16.0±0.1	2.0±0.05	24.0±0.3	7.0	0.34
SLF12575	13	13	1.5+0.1/-0	1.75±0.1	11.5±0.1	4.0±0.1	16.0±0.1	2.0±0.05	24.0±0.3	8.0	0.34

• All specifications are subject to change without notice.