



Inductors for Power Circuits

Wound Ferrite

CLF series

CLF6045

CLF7045

CLF10040

CLF12555

REMINDERS FOR USING THESE PRODUCTS

Before using these products, be sure to request the delivery specifications.

SAFETY REMINDERS

Please pay sufficient attention to the warnings for safe designing when using these products.

REMINDERS

- The storage period is less than 6 months. Be sure to follow the storage conditions (Temperature: 5 to 30°C, Humidity: 10 to 75% RH or less).
If the storage period elapses, the soldering of the terminal electrodes may deteriorate.
- Do not use or store in locations where there are conditions such as gas corrosion (salt, acid, alkali, etc.).
- Before soldering, be sure to preheat components.
The preheating temperature should be set so that the temperature difference between the solder temperature and chip temperature does not exceed 150°C.
- Soldering corrections after mounting should be within the range of the conditions determined in the specifications.
If overheated, a short circuit, performance deterioration, or lifespan shortening may occur.
- When embedding a printed circuit board where a chip is mounted to a set, be sure that residual stress is not given to the chip due to the overall distortion of the printed circuit board and partial distortion such as at screw tightening portions.
- Self heating (temperature increase) occurs when the power is turned ON, so the tolerance should be sufficient for the set thermal design.
- Carefully lay out the coil for the circuit board design of the non-magnetic shield type.
A malfunction may occur due to magnetic interference.
- Use a wrist band to discharge static electricity in your body through the grounding wire.
- Do not expose the products to magnets or magnetic fields.
- Do not use for a purpose outside of the contents regulated in the delivery specifications.
- The products listed on this catalog are intended for use in general electronic equipment (AV equipment, telecommunications equipment, home appliances, amusement equipment, computer equipment, personal equipment, office equipment, measurement equipment, industrial robots) under a normal operation and use condition.
The products are not designed or warranted to meet the requirements of the applications listed below, whose performance and/or quality require a more stringent level of safety or reliability, or whose failure, malfunction or trouble could cause serious damage to society, person or property.
If you intend to use the products in the applications listed below or if you have special requirements exceeding the range or conditions set forth in the each catalog, please contact us.

- (1) Aerospace/Aviation equipment
- (2) Transportation equipment (cars, electric trains, ships, etc.)
- (3) Medical equipment
- (4) Power-generation control equipment
- (5) Atomic energy-related equipment
- (6) Seabed equipment
- (7) Transportation control equipment

- (8) Public information-processing equipment
- (9) Military equipment
- (10) Electric heating apparatus, burning equipment
- (11) Disaster prevention/crime prevention equipment
- (12) Safety equipment
- (13) Other applications that are not considered general-purpose applications

When designing your equipment even for general-purpose applications, you are kindly requested to take into consideration securing protection circuit/device or providing backup circuits in your equipment.

Inductors for Power Circuits

Product compatible with RoHS directive
Compatible with lead-free solders

Wound Ferrite

Overview of the CLF Series

FEATURES

- Magnetic shield type wound inductor for power circuits.
- 1 to 470 μ H, wide E-6 Series lineup allows for various usages.

APPLICATION

Thin-screen TVs, LCDs, AV equipment, STBs, LED lights, industrial equipment

PART NUMBER CONSTRUCTION

CLF	7045	T	-	1R5	N
Series name	LxWxH Dimensions (mm)	Packaging style		Inductance (μ H)	Inductance tolerance
	6045 6.2x5.9x4.5	T	Taping	1R0 1.0	M $\pm 20\%$
	7045 7.2x6.9x4.5			100 10	N $\pm 30\%$
	10040 10.0x9.7x3.8			101 100	
	12555 12.5x12.1x5.5				

OPERATING TEMPERATURE RANGE, PACKAGE QUANTITY, PRODUCT WEIGHT

Type	Temperature range		Package quantity (pieces/reel)	Individual weight (g)
	Operating temperature*	Storage temperature**		
	($^{\circ}$ C)	($^{\circ}$ C)		
CLF6045	-40 to +105	-40 to +105	1000	0.6
CLF7045	-40 to +105	-40 to +105	1000	0.8
CLF10040	-40 to +105	-40 to +105	800	1.3
CLF12555	-40 to +105	-40 to +105	500	3.0

* Operating temperature range includes self-temperature rise.

** The Storage temperature range is for after the circuit board is mounted.

○ RoHS Directive Compliant Product: See the following for more details related to RoHS Directive compliant products. <http://www.tdk.co.jp/rohs/>

• All specifications are subject to change without notice.

Overview of the CLF Series

RECOMMENDED REFLOW PROFILE

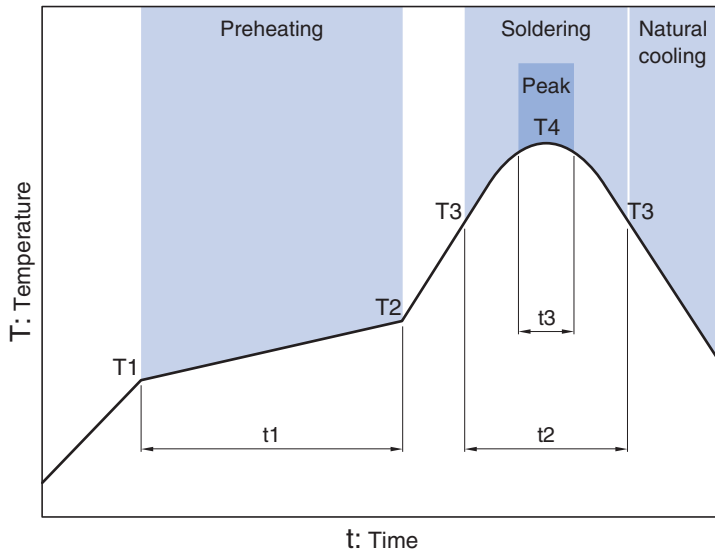

Preheating			Soldering		Peak	
Temp.	Temp.	Time	Temp.	Time	Temp.	Time
T1	T2	t1	T3	t2	T4	t3
150°C	180°C	60 to 120s	230°C	30s	250°C	5s

CLF series

CLF6045 Type



SHAPE & DIMENSIONS



Dimensions in mm

RECOMMENDED LAND PATTERN



Dimensions in mm

• All specifications are subject to change without notice.

CLF series **CLF6045 Type**

■ ELECTRICAL CHARACTERISTICS

□ CHARACTERISTICS SPECIFICATION TABLE

L (μH)	Tolerance	Measuring frequency (kHz)	DC resistance (Ω)	Rated current*		Part No.
				Idc1	Idc2	
1.0	$\pm 30\%$	100	11m $\pm 30\%$	5.0	4.5	CLF6045T-1R0N
1.5	$\pm 30\%$	100	13m $\pm 30\%$	4.4	4.2	CLF6045T-1R5N
2.2	$\pm 30\%$	100	15m $\pm 30\%$	3.9	4.0	CLF6045T-2R2N
3.3	$\pm 30\%$	100	19m $\pm 30\%$	3.1	3.5	CLF6045T-3R3N
4.7	$\pm 30\%$	100	23m $\pm 30\%$	2.5	3.2	CLF6045T-4R7N
6.8	$\pm 30\%$	100	27m $\pm 30\%$	2.2	2.9	CLF6045T-6R8N
10	$\pm 20\%$	100	38m $\pm 20\%$	1.7	2.4	CLF6045T-100M
15	$\pm 20\%$	100	55m $\pm 20\%$	1.5	2.0	CLF6045T-150M
22	$\pm 20\%$	100	78m $\pm 20\%$	1.3	1.7	CLF6045T-220M
33	$\pm 20\%$	100	0.103 $\pm 20\%$	1.07	1.5	CLF6045T-330M
47	$\pm 20\%$	100	0.130 $\pm 20\%$	0.90	1.3	CLF6045T-470M
68	$\pm 20\%$	100	0.215 $\pm 20\%$	0.79	1.0	CLF6045T-680M
100	$\pm 20\%$	100	0.340 $\pm 20\%$	0.64	0.70	CLF6045T-101M
150	$\pm 20\%$	100	0.480 $\pm 20\%$	0.50	0.60	CLF6045T-151M
220	$\pm 20\%$	100	0.780 $\pm 20\%$	0.41	0.50	CLF6045T-221M
330	$\pm 20\%$	100	0.970 $\pm 20\%$	0.35	0.44	CLF6045T-331M
470	$\pm 20\%$	100	1.42 $\pm 20\%$	0.30	0.37	CLF6045T-471M

* Rated current: smaller value of either Idc1 or Idc2.

Idc1: When based on the inductance change rate (10% below the initial value)

Idc2: When based on the temperature increase (Temperature increase of 30°C)

○ Measurement equipment

Measurement item	Product No.	Manufacturer
L	4285A	Agilent Technologies
DC resistance	VP-2941A	Panasonic
Rated current Idc1	4285A+42841A+42842C	Agilent Technologies

* Equivalent measurement equipment may be used.

CLF series **CLF6045 Type**

■ ELECTRICAL CHARACTERISTICS

□ L FREQUENCY CHARACTERISTICS GRAPH



○ Measurement equipment

Product No.	Manufacturer
4294A	Agilent Technologies

* Equivalent measurement equipment may be used.

CLF series CLF6045 Type

ELECTRICAL CHARACTERISTICS

INDUCTANCE VS. DC BIAS CHARACTERISTICS GRAPH

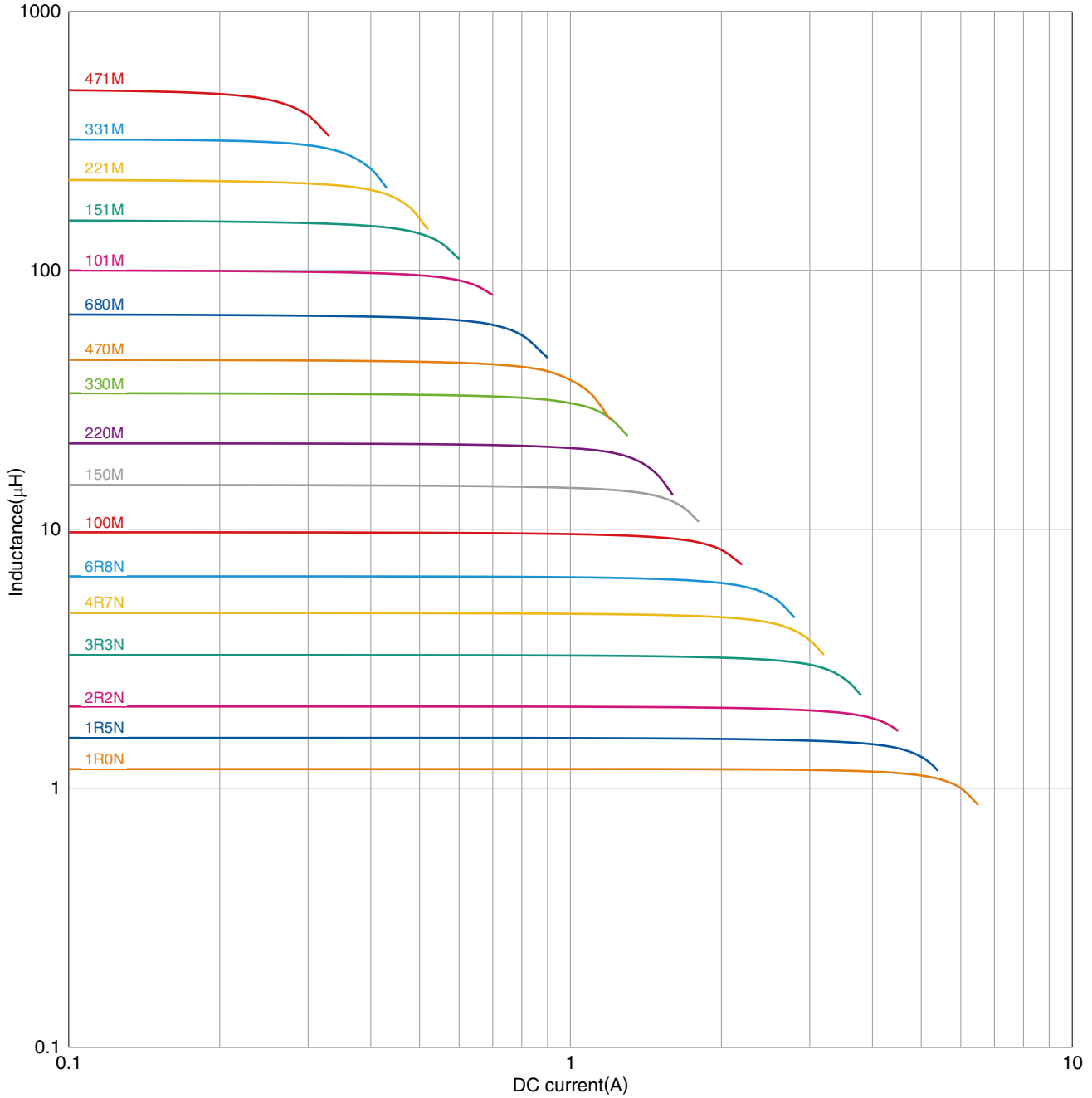

○ Measurement equipment

Product No.	Manufacturer
4285A+42841A+42842C	Agilent Technologies

* Equivalent measurement equipment may be used.

CLF series

CLF7045 Type



SHAPE & DIMENSIONS

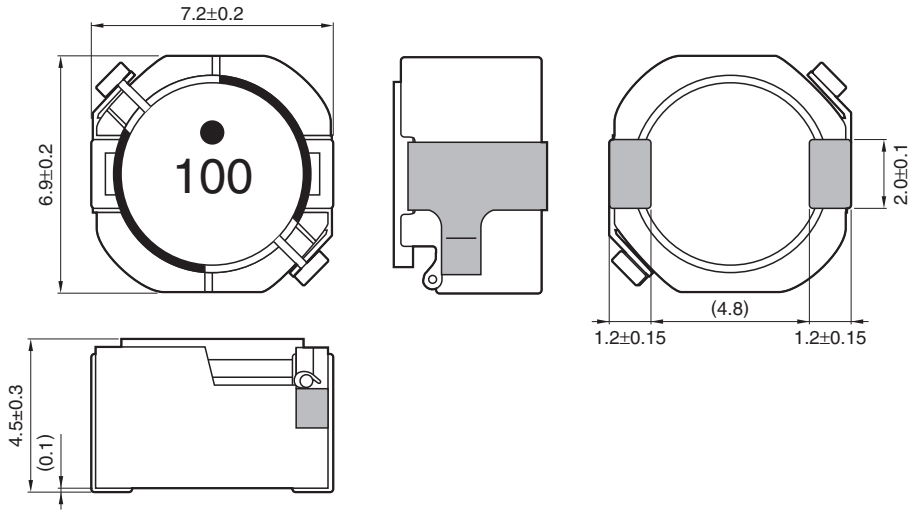

Dimensions in mm

RECOMMENDED LAND PATTERN



Dimensions in mm

• All specifications are subject to change without notice.

CLF series CLF7045 Type

■ ELECTRICAL CHARACTERISTICS

□ CHARACTERISTICS SPECIFICATION TABLE

L (μ H)	Tolerance	Measuring frequency (kHz)	DC resistance (Ω)	Rated current*		Part No.
				Idc1	Idc2	
1.0	$\pm 30\%$	100	9.6m $\pm 30\%$	8.9	5.2	CLF7045T-1R0N
1.5	$\pm 30\%$	100	11.0m $\pm 30\%$	7.3	4.9	CLF7045T-1R5N
2.2	$\pm 30\%$	100	14.6m $\pm 30\%$	5.5	4.3	CLF7045T-2R2N
3.3	$\pm 30\%$	100	16.4m $\pm 30\%$	5.0	4.1	CLF7045T-3R3N
4.7	$\pm 30\%$	100	20m $\pm 30\%$	4.1	3.6	CLF7045T-4R7N
6.8	$\pm 30\%$	100	27m $\pm 30\%$	3.3	3.0	CLF7045T-6R8N
10	$\pm 20\%$	100	38m $\pm 20\%$	2.7	2.5	CLF7045T-100M
15	$\pm 20\%$	100	51m $\pm 20\%$	2.3	2.1	CLF7045T-150M
22	$\pm 20\%$	100	69m $\pm 20\%$	1.9	1.8	CLF7045T-220M
33	$\pm 20\%$	100	0.11 $\pm 20\%$	1.55	1.40	CLF7045T-330M
47	$\pm 20\%$	100	0.15 $\pm 20\%$	1.30	1.20	CLF7045T-470M
68	$\pm 20\%$	100	0.21 $\pm 20\%$	1.10	0.95	CLF7045T-680M
100	$\pm 20\%$	100	0.33 $\pm 20\%$	0.90	0.75	CLF7045T-101M
150	$\pm 20\%$	100	0.48 $\pm 20\%$	0.67	0.61	CLF7045T-151M
220	$\pm 20\%$	100	0.66 $\pm 20\%$	0.62	0.52	CLF7045T-221M
330	$\pm 20\%$	100	1.03 $\pm 20\%$	0.49	0.42	CLF7045T-331M
470	$\pm 20\%$	100	1.42 $\pm 20\%$	0.43	0.37	CLF7045T-471M

* Rated current: smaller value of either Idc1 or Idc2.

Idc1: When based on the inductance change rate (10% below the initial value)

Idc2: When based on the temperature increase (Temperature increase of 30°C)

○ Measurement equipment

Measurement item	Product No.	Manufacturer
L	4285A	Agilent Technologies
DC resistance	VP-2941A	Panasonic
Rated current Idc1	4285A+42841A+42842C	Agilent Technologies

* Equivalent measurement equipment may be used.

CLF series **CLF7045 Type**

■ ELECTRICAL CHARACTERISTICS

□ L FREQUENCY CHARACTERISTICS GRAPH

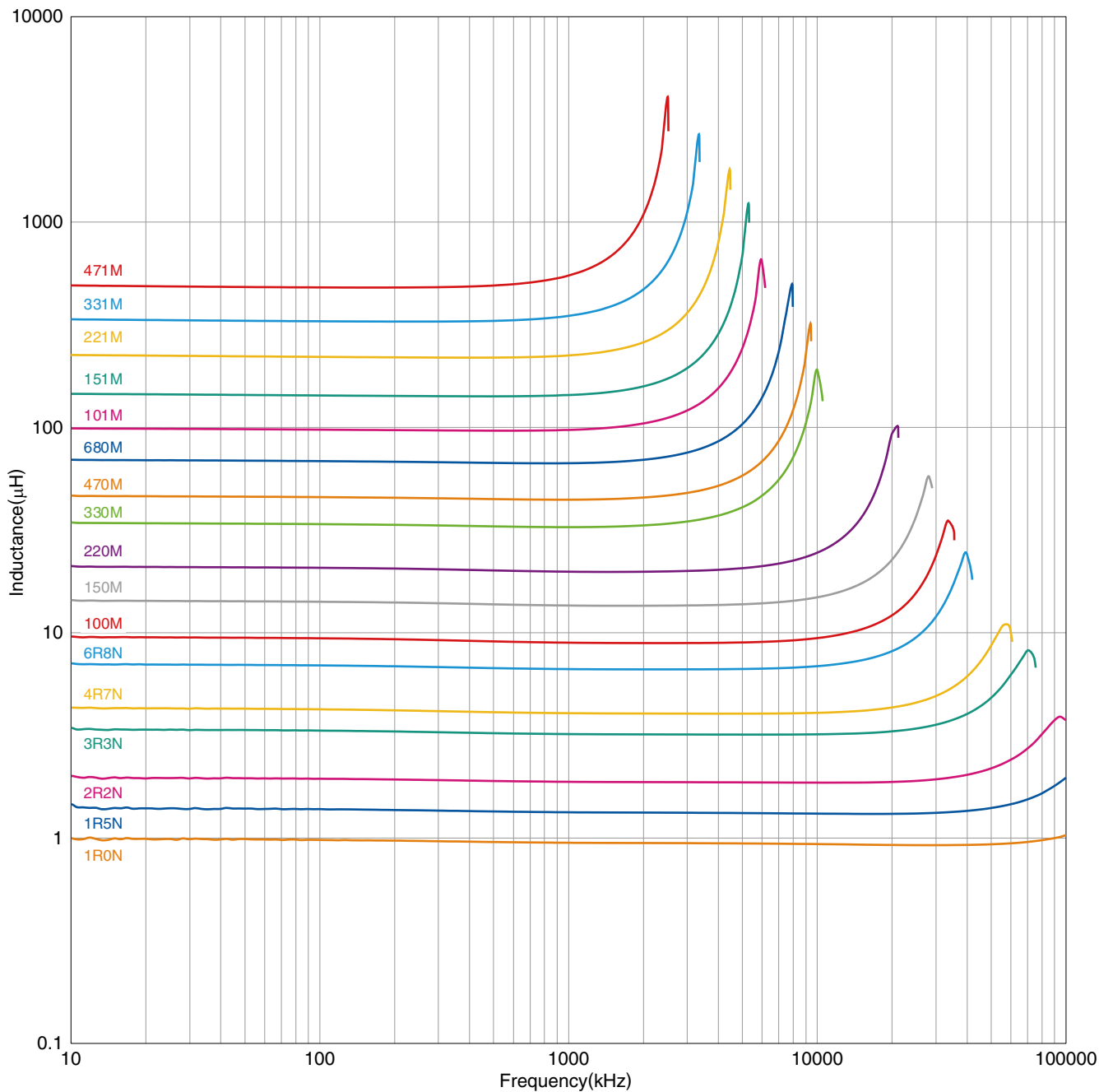

○ Measurement equipment

Product No.	Manufacturer
4294A	Agilent Technologies

* Equivalent measurement equipment may be used.

• All specifications are subject to change without notice.

CLF series CLF7045type

ELECTRICAL CHARACTERISTICS

INDUCTANCE VS. DC BIAS CHARACTERISTICS GRAPH



○ Measurement equipment

Product No.	Manufacturer
4285A+42841A+42842C	Agilent Technologies

* Equivalent measurement equipment may be used.

CLF series

CLF10040 Type



SHAPE & DIMENSIONS



Dimensions in mm

RECOMMENDED LAND PATTERN

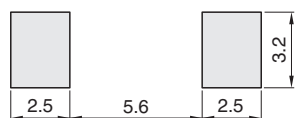

Dimensions in mm

• All specifications are subject to change without notice.

CLF series **CLF10040 Type**

■ ELECTRICAL CHARACTERISTICS

□ CHARACTERISTICS SPECIFICATION TABLE

L (μ H)	Tolerance	Measuring frequency (kHz)	DC resistance (Ω)	Rated current*		Part No.
				Idc1	Idc2	
1.0	$\pm 30\%$	100	5.7m $\pm 30\%$	12.0	6.3	CLF10040T-1R0N
1.5	$\pm 30\%$	100	7.1m $\pm 30\%$	10.6	5.8	CLF10040T-1R5N
2.2	$\pm 30\%$	100	9.7m $\pm 30\%$	7.5	5.0	CLF10040T-2R2N
3.3	$\pm 30\%$	100	11.0m $\pm 30\%$	6.6	4.8	CLF10040T-3R3N
4.7	$\pm 30\%$	100	14.5m $\pm 30\%$	5.4	4.2	CLF10040T-4R7N
6.8	$\pm 30\%$	100	18.5m $\pm 30\%$	4.8	3.7	CLF10040T-6R8N
10	$\pm 20\%$	100	26m $\pm 20\%$	4.0	3.3	CLF10040T-100M
15	$\pm 20\%$	100	40m $\pm 20\%$	3.2	2.5	CLF10040T-150M
22	$\pm 20\%$	100	55m $\pm 20\%$	2.7	2.2	CLF10040T-220M
33	$\pm 20\%$	100	80m $\pm 20\%$	2.2	1.7	CLF10040T-330M
47	$\pm 20\%$	100	125m $\pm 20\%$	1.9	1.3	CLF10040T-470M
68	$\pm 20\%$	100	0.18 $\pm 20\%$	1.6	1.1	CLF10040T-680M
100	$\pm 20\%$	100	0.24 $\pm 20\%$	1.3	1.0	CLF10040T-101M
150	$\pm 20\%$	100	0.38 $\pm 20\%$	1.0	0.8	CLF10040T-151M
220	$\pm 20\%$	100	0.52 $\pm 20\%$	0.88	0.70	CLF10040T-221M
330	$\pm 20\%$	100	0.86 $\pm 20\%$	0.70	0.53	CLF10040T-331M
470	$\pm 20\%$	100	1.21 $\pm 20\%$	0.56	0.44	CLF10040T-471M

* Rated current: smaller value of either Idc1 or Idc2.

Idc1: When based on the inductance change rate (10% below the initial value)

Idc2: When based on the temperature increase (Temperature increase of 30°C)

○ Measurement equipment

Measurement item	Product No.	Manufacturer
L	4285A	Agilent Technologies
DC resistance	VP-2941A	Panasonic
Rated current Idc1	4285A+42841A+42842C	Agilent Technologies

* Equivalent measurement equipment may be used.

CLF series CLF10040 Type

ELECTRICAL CHARACTERISTICS

L FREQUENCY CHARACTERISTICS GRAPH



○ Measurement equipment

Product No.	Manufacturer
4294A	Agilent Technologies

* Equivalent measurement equipment may be used.

• All specifications are subject to change without notice.

CLF series CLF10040 Type

ELECTRICAL CHARACTERISTICS

INDUCTANCE VS. DC BIAS CHARACTERISTICS GRAPH

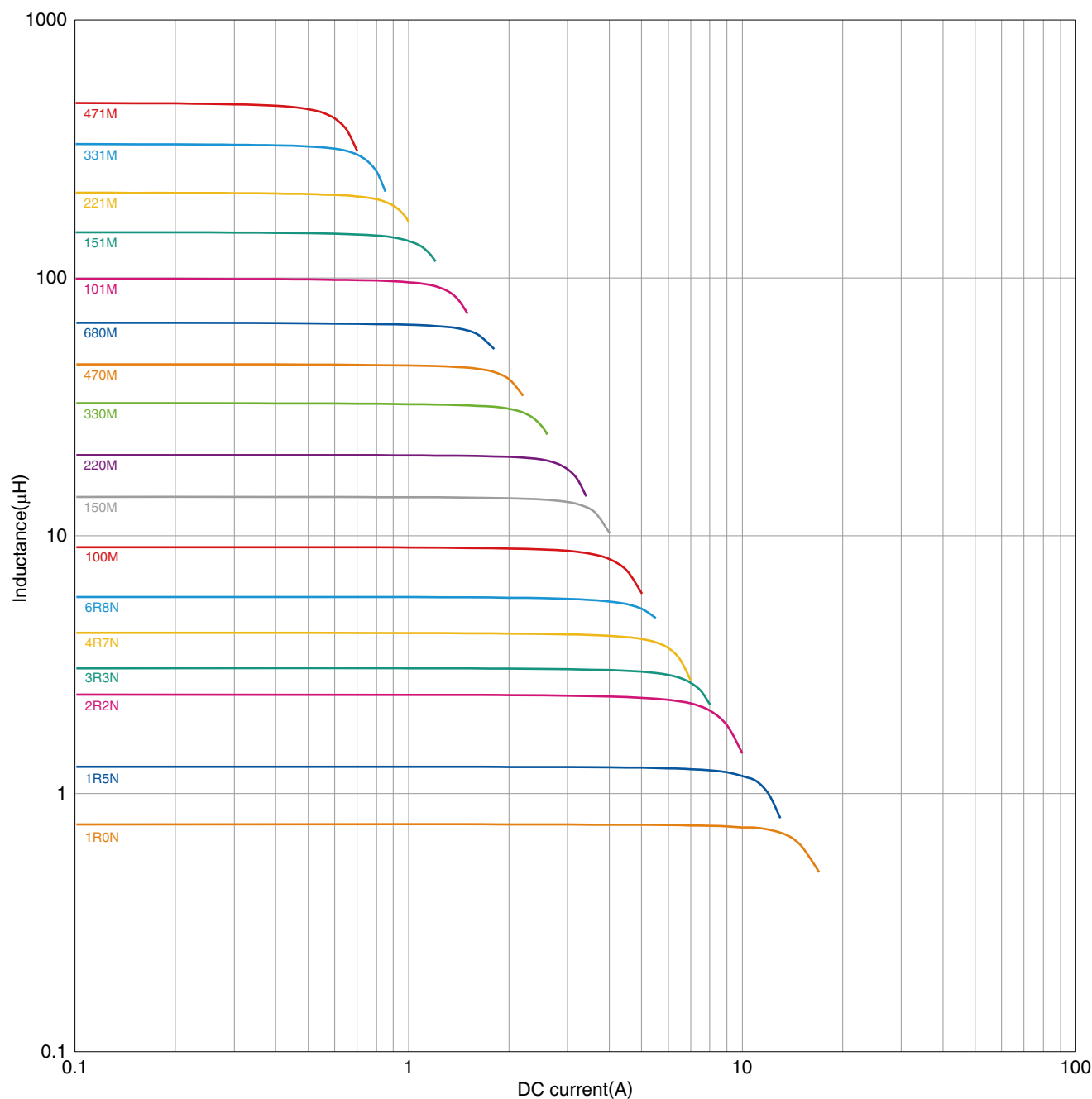

○ Measurement equipment

Product No.	Manufacturer
4285A+42841A+42842C	Agilent Technologies

* Equivalent measurement equipment may be used.

CLF series

CLF12555 Type



SHAPE & DIMENSIONS



Dimensions in mm

RECOMMENDED LAND PATTERN



Dimensions in mm

CLF series CLF12555 Type

■ ELECTRICAL CHARACTERISTICS

□ CHARACTERISTICS SPECIFICATION TABLE

L (μ H)	Tolerance	Measuring frequency (kHz)	DC resistance (Ω)	Rated current*		Part No.
				Idc1	Idc2	
1.0	$\pm 30\%$	100	6.4m $\pm 30\%$	20.0	7.3	CLF12555T-1R0N
1.5	$\pm 30\%$	100	7.3m $\pm 30\%$	16.4	6.7	CLF12555T-1R5N
2.2	$\pm 30\%$	100	8.8m $\pm 30\%$	13.1	6.1	CLF12555T-2R2N
3.3	$\pm 30\%$	100	10.3m $\pm 30\%$	11.4	5.7	CLF12555T-3R3N
4.7	$\pm 30\%$	100	11.7m $\pm 30\%$	9.6	5.3	CLF12555T-4R7N
6.8	$\pm 30\%$	100	15.0m $\pm 30\%$	8.0	4.7	CLF12555T-6R8N
10	$\pm 20\%$	100	21m $\pm 20\%$	6.7	3.9	CLF12555T-100M
15	$\pm 20\%$	100	31m $\pm 20\%$	5.4	3.2	CLF12555T-150M
22	$\pm 20\%$	100	43m $\pm 20\%$	4.8	2.8	CLF12555T-220M
33	$\pm 20\%$	100	67m $\pm 20\%$	4.0	2.2	CLF12555T-330M
47	$\pm 20\%$	100	100m $\pm 20\%$	3.2	1.8	CLF12555T-470M
68	$\pm 20\%$	100	125m $\pm 20\%$	2.6	1.6	CLF12555T-680M
100	$\pm 20\%$	100	190m $\pm 20\%$	2.1	1.3	CLF12555T-101M
150	$\pm 20\%$	100	260m $\pm 20\%$	1.8	1.1	CLF12555T-151M
220	$\pm 20\%$	100	370m $\pm 20\%$	1.5	0.9	CLF12555T-221M
330	$\pm 20\%$	100	560m $\pm 20\%$	1.2	0.7	CLF12555T-331M
470	$\pm 20\%$	100	795m $\pm 20\%$	1.0	0.6	CLF12555T-471M

* Rated current: smaller value of either Idc1 or Idc2.

Idc1: When based on the inductance change rate (10% below the initial value)

Idc2: When based on the temperature increase (Temperature increase of 30°C)

○ Measurement equipment

Measurement item	Product No.	Manufacturer
L	4285A	Agilent Technologies
DC resistance	VP-2941A	Panasonic
Rated current Idc1	4285A+42841A+42842C	Agilent Technologies

* Equivalent measurement equipment may be used.

CLF series CLF12555 Type

ELECTRICAL CHARACTERISTICS

FREQUENCY CHARACTERISTICS GRAPH



○ Measurement equipment

Product No.	Manufacturer
4294A	Agilent Technologies

* Equivalent measurement equipment may be used.

CLF series CLF12555 Type

ELECTRICAL CHARACTERISTICS

INDUCTANCE VS. DC BIAS CHARACTERISTICS GRAPH

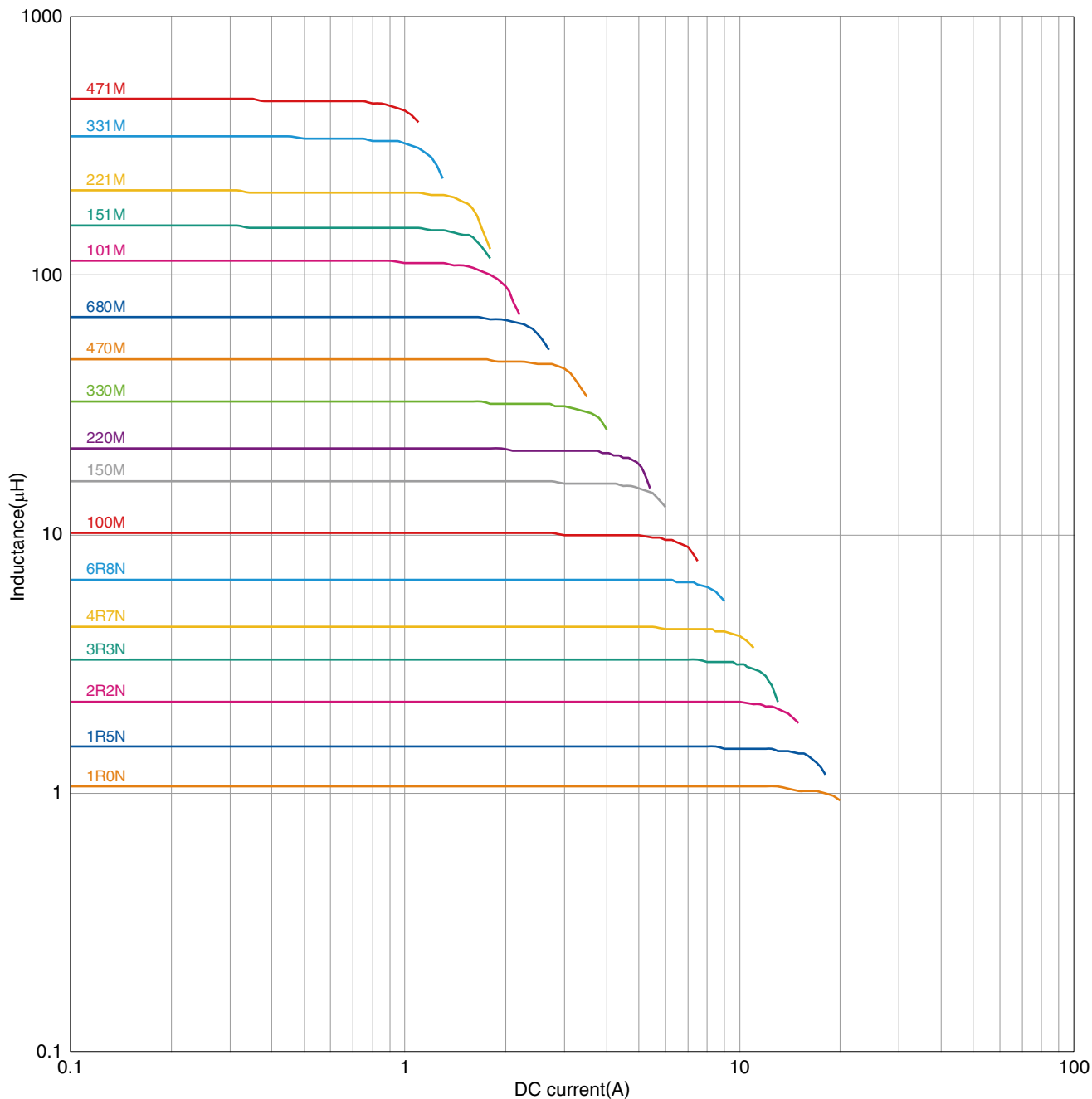

○ Measurement equipment

Product No.	Manufacturer
4285A+42841A+42842C	Agilent Technologies

* Equivalent measurement equipment may be used.

• All specifications are subject to change without notice.

CLF series

Packaging Style

REEL DIMENSIONS



Type	A	W1	W2	N	E
CLF6045	ø330	16.4	22.4	ø50	2
CLF7045	ø330	16.4	22.4	ø50	2
CLF10040	ø330	24.4	30.4	ø50	2
CLF12555	ø330	24.4	30.4	ø50	2

* These values are typical values.

TAPE DIMENSIONS

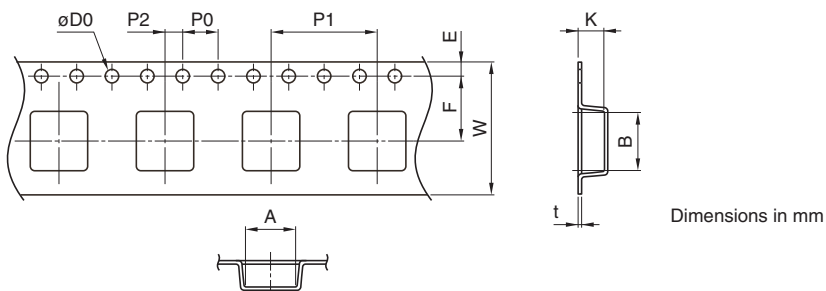

Type	A	B	øD0	E	F	P0	P1	P2	W	K	t
CLF6045	6.4	6.4	1.5+0.1/-0	1.75±0.1	7.5±0.1	4.0±0.1	12.0±0.1	2.0±0.1	16.0±0.3	4.9	0.4
CLF7045	7.5	7.5	1.5+0.1/-0	1.75±0.1	7.5±0.1	4.0±0.1	12.0±0.1	2.0±0.1	16.0±0.3	4.9	0.4
CLF10040	10.4	10.4	1.5+0.1/-0	1.75±0.1	11.5±0.1	4.0±0.1	16.0±0.1	2.0±0.1	24.0±0.3	4.6	0.5
CLF12555	12.9	12.9	1.5+0.1/-0	1.75±0.1	11.5±0.1	4.0±0.1	16.0±0.1	2.0±0.1	24.0±0.3	6.1	0.5

• All specifications are subject to change without notice.