

SPECIFICATION

SPEC. No. D2013-C9
DATE: 2013 Sep.

To

Non-Controlled Copy

CUSTOMER'S PRODUCT NAME

TDK'S PRODUCT NAME

Multilayer ceramic capacitors
Dipped radial lead type
FK-Series
General (Up to 50V)
Mid voltage (100 to 630V)

RECEIPT CONFIRMATION

DATE: _____ YEAR _____ MONTH _____ DAY _____

TDK Corporation
Sales

Engineering

Electronic Components Sales &
Marketing Group

TDK-EPC CORPORATION
Ceramic Capacitors Business Group
TDK-MCC CORPORATION
DIELECTRIC PRODUCTS ENGINEERING DEPT.

APPROVED	Person in charge

APPROVED	CHECKED	Person in charge

1. SCOPE

This specification is applicable to multilayer ceramic capacitors dipped radial lead type with a priority over the other relevant specifications.

Production places defined in this specification shall be TDK Xiamen Co., Ltd. (China).

EXPLANATORY NOTE:

This specification warrants the quality of the lead type ceramic capacitor. The parts should be evaluated or confirmed a state of used on your product.

If the use of the parts go beyond the bounds of the specification, we can not afford to guarantee.

2. CODE CONSTRUCTION

(Example) $\frac{\text{FK28}}{(1)}$ $\frac{\text{X7R}}{(2)}$ $\frac{\text{1H}}{(3)}$ $\frac{\text{104}}{(4)}$ $\frac{\text{K}}{(5)}$ $\frac{\text{N006}}{(6)}$

(1)Type

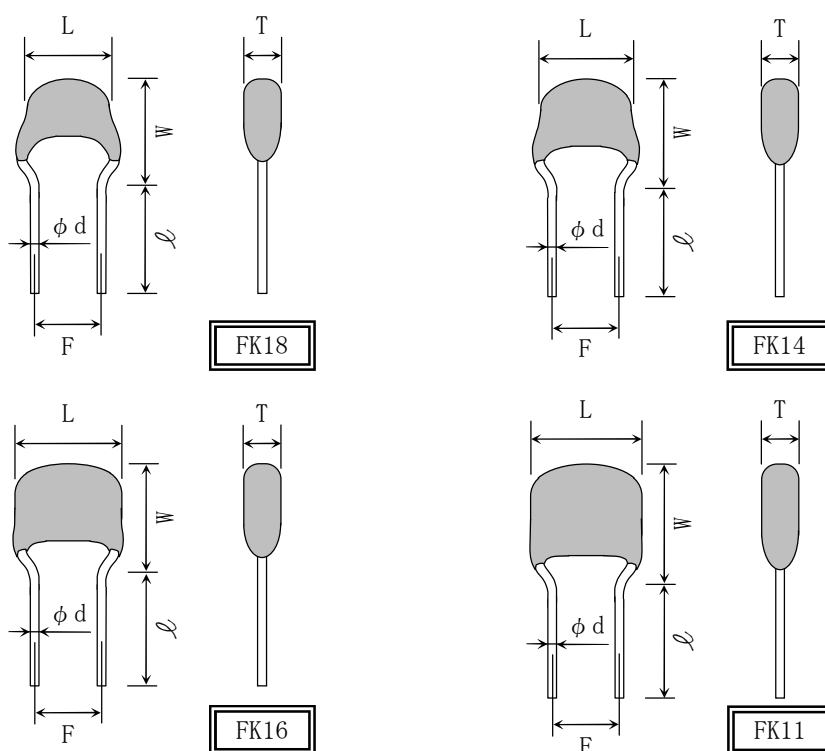

Type	Dimensions (Unit : mm)					
	L(max.)	W(max.)	T(max.)	F	l	ϕd
FK18	4.0	5.5	2.5	2.5±0.8	5.0	0.5
FK14	4.5	5.5	2.5			
FK16	5.5	6.0	3.5			
FK11	5.5	7.0	4.0			
					+3.0 -1.0	+0.10 -0.03

*FK denotes forming lead.

The first digit refers to a distance between leads (1—2.5mm),
the second digit is for TDK internal code.

*Dimension l is applied to bulk packaging.

Refer to Appendix 2 for dimension of taping packaging.

(1) Type

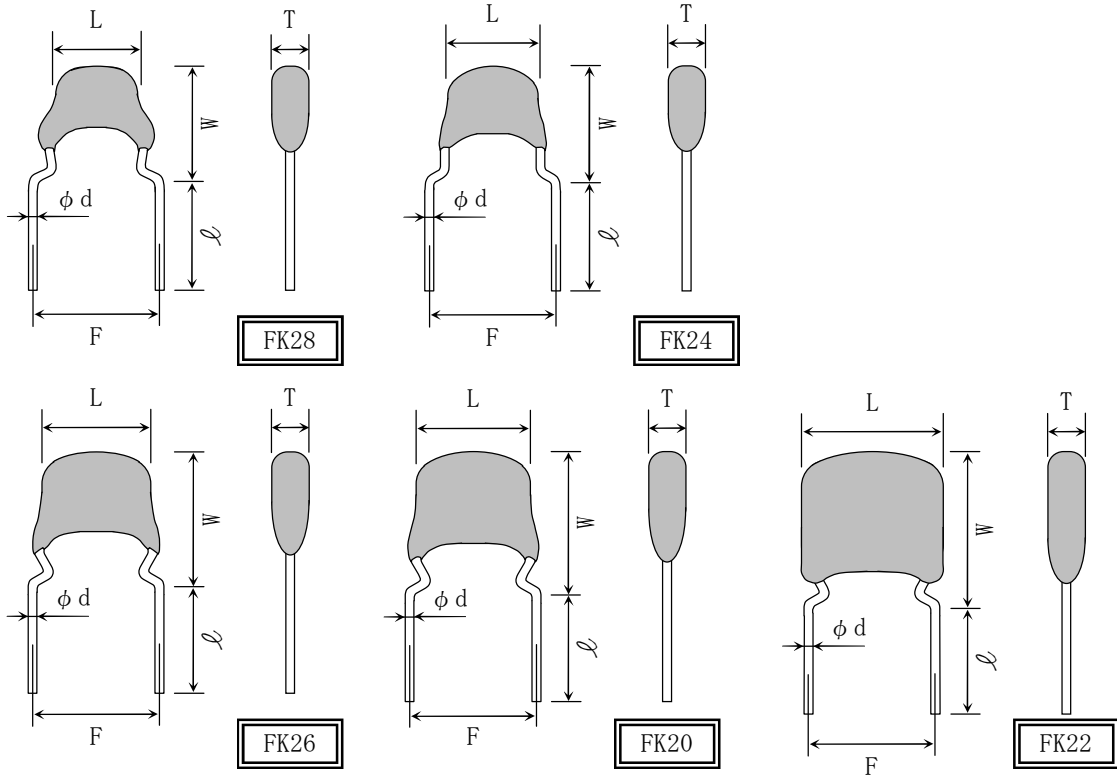

Type	Dimensions (Unit : mm)					
	L(max.)	W(max.)	T(max.)	F	l	ϕ d
FK28	4.0	5.5	2.5	5.0±1.0	7.0±2.0	0.5 +0.10 -0.03
FK24	4.5	5.5	2.5			
FK26	5.5	6.0	3.5			
FK20	5.5	7.0	4.0			
FK22	7.5	8.0	4.0			

*FK denotes forming lead.

The first digit refers to a distance between leads (2–5.0mm),
the second digit is for TDK internal code.

*Dimension *l* is applied to bulk packaging.

Refer to Appendix 3 for dimension of taping packaging.

(2) Temperature Characteristics (Details are shown in para 7 No. 7, 8)

(3) Rated Voltage

Symbol	Rated Voltage
2 J	DC 630 V
2 E	DC 250 V
2 A	DC 100 V
1 H	DC 50 V
1 E	DC 25 V
1 C	DC 16 V
1 A	DC 10 V
0 J	DC 6.3 V

(4) Rated Capacitance

Stated in three digits and in units of pico farads (pF). The first and second digits identify the first and second significant figures of the capacitance, the third digit identifies the multiplier.

R is designated for a decimal point.

Example 2R2 → 2.2pF
 104 → 100,000pF

(5) Capacitance tolerance

Symbol	Tolerance	Capacitance (C)
C	±0.25 pF	$C \leq 5\text{pF}$
D	±0.5 pF	$5\text{pF} < C \leq 10\text{pF}$
J	± 5 %	Over 10pF
K	±10 %	
M	±20 %	

(6) Internal code

Symbol	Applied voltage of Life	Packaging
N020	Rated voltage ×2	Bulk (FK1*type)
N000		Bulk (FK2*type)
N006		Ammo Pack
R020	Rated voltage ×1	Bulk (FK1*type)
R000		Bulk (FK2*type)
R006		Ammo Pack

3.1 Standard combination of rated capacitances and tolerances

Class	Temperature Characteristics	Capacitance tolerance (*1)		Rated capacitance
1	COG	$C \leq 5$	C (± 0.25 pF)	1, 1.5, 2, 2.2, 3, 3.3, 4, 4.7, 5
		$5 < C \leq 10$	D (± 0.5 pF)	6, 6.8, 7, 8, 9, 10
		$10 < C \leq 10,000$	J (± 5 %)	E-12 series
		$10,000 < C$	J (± 5 %)	E-6 series
2	X5R X7R X7S	$C \leq 0.1$	K (± 10 %)	E-6 series
		$0.1 < C \leq 10$	K (± 10 %)	E-6 series
		$10 < C$	M (± 20 %)	

*1 C denotes Capacitance.

Unit : pF for Class1 and μ F for Class2.

3.2 Capacitance Step in E series

E series	Capacitance Step											
E-3	1			2.2				4.7				
E-6	1	1.5	2.2	3.3	4.7	6.8						
E-12	1	1.2	1.5	1.8	2.2	2.7	3.3	3.9	4.7	5.6	6.8	8.2

4. OPERATING TEMPERATURE RANGE

T. C.	Min. operating Temperature	Max. operating Temperature	Reference Temperature
X5R	-55°C	85°C	25°C
COG X7R X7S	-55°C	125°C	25°C

5. STORING CONDITION AND TERM

5 to 40°C at 20 to 70%RH

6 months Max.

6. INDUSTRIAL WASTE DISPOSAL

Dispose this product as industrial waste in accordance with the industrial Waste Law.

7. PERFORMANCE

table 1

No.	Item		Performance	Test or inspection method													
1	External Appearance		No defects which may affect performance.	By visual checking.													
2	Indication	Appearance	Meet a requirement per para 8.	<table border="1"> <thead> <tr> <th>solvent</th> <th>Solvent temp.</th> <th>Dipping time</th> </tr> </thead> <tbody> <tr> <td>Isopropyl alcohol</td> <td>20~25 °C</td> <td>30±5s.</td> </tr> </tbody> </table>	solvent	Solvent temp.	Dipping time	Isopropyl alcohol	20~25 °C	30±5s.							
		solvent	Solvent temp.		Dipping time												
Isopropyl alcohol	20~25 °C	30±5s.															
Resistance to solvent	Shall be visible.																
3	Voltage Proof	Between termination	No insulation breakdown or other damage.	<table border="1"> <thead> <tr> <th>Class</th> <th>Rated voltage</th> <th>Apply voltage</th> </tr> </thead> <tbody> <tr> <td rowspan="2">Class1</td> <td>100V and under</td> <td>Rated voltage ×3</td> </tr> <tr> <td>Over 100V</td> <td>Rated voltage ×1.5</td> </tr> <tr> <td rowspan="2">Class2</td> <td>100V and under</td> <td>Rated voltage ×2.5</td> </tr> <tr> <td>Over 100V</td> <td>Rated voltage ×1.5</td> </tr> </tbody> </table> <p>Above DC voltage shall be applied for 1~5s.</p> <p>Charge / discharge current shall not exceed 50mA.</p>	Class	Rated voltage	Apply voltage	Class1	100V and under	Rated voltage ×3	Over 100V	Rated voltage ×1.5	Class2	100V and under	Rated voltage ×2.5	Over 100V	Rated voltage ×1.5
		Class	Rated voltage		Apply voltage												
Class1	100V and under	Rated voltage ×3															
	Over 100V	Rated voltage ×1.5															
Class2	100V and under	Rated voltage ×2.5															
	Over 100V	Rated voltage ×1.5															
Between termination coating	No insulation breakdown or other damage.	Apply ×2.5 rated voltage. (By metallic small ball method.)															
4	Insulation Resistance		10,000MΩ or 500 MΩ · μF min. (As for the capacitor of rated voltage 16,10 and 6.3V DC, 10,000 MΩ or 100 MΩ · μF min.,) whichever smaller.	<p>«250V DC and under» Apply rated voltage.</p> <p>«630V DC» Apply DC500V. Applying time : 60sec.</p>													
5	Capacitance		Within the specified tolerance.	Class 1													
				<table border="1"> <thead> <tr> <th>Rated capacitance</th> <th>Measuring frequency</th> <th>Measuring voltage</th> </tr> </thead> <tbody> <tr> <td>1,000pF and under</td> <td>1MHz ±10%</td> <td rowspan="2">0.5~5 Vrms.</td> </tr> <tr> <td>Over 1,000pF</td> <td>1kHz ±10%</td> </tr> </tbody> </table>	Rated capacitance	Measuring frequency	Measuring voltage	1,000pF and under	1MHz ±10%	0.5~5 Vrms.	Over 1,000pF	1kHz ±10%					
Rated capacitance	Measuring frequency	Measuring voltage															
1,000pF and under	1MHz ±10%	0.5~5 Vrms.															
Over 1,000pF	1kHz ±10%																
		Class 2		<table border="1"> <thead> <tr> <th>Rated capacitance</th> <th>Measuring frequency</th> <th>Measuring voltage</th> </tr> </thead> <tbody> <tr> <td>10 μF and under</td> <td>1kHz ±10%</td> <td>1.0±0.2 Vrms.</td> </tr> <tr> <td>Over 10 μF</td> <td>120Hz ±10%</td> <td>0.5±0.2 Vrms.</td> </tr> </tbody> </table>	Rated capacitance	Measuring frequency	Measuring voltage	10 μF and under	1kHz ±10%	1.0±0.2 Vrms.	Over 10 μF	120Hz ±10%	0.5±0.2 Vrms.				
Rated capacitance	Measuring frequency	Measuring voltage															
10 μF and under	1kHz ±10%	1.0±0.2 Vrms.															
Over 10 μF	120Hz ±10%	0.5±0.2 Vrms.															
6	Q (Class 1)		As per Table 2.	See No.5 in this table for measuring condition.													
	Dissipation Factor (Class 2)		<table border="1"> <thead> <tr> <th>T. C.</th> <th>D. F.</th> </tr> </thead> <tbody> <tr> <td></td> <td>0.03 max.</td> </tr> <tr> <td>X5R</td> <td>0.05 max.</td> </tr> <tr> <td>X7R</td> <td>0.075 max.</td> </tr> <tr> <td>X7S</td> <td>0.10 max.</td> </tr> <tr> <td></td> <td>0.15 max.</td> </tr> </tbody> </table>		T. C.	D. F.		0.03 max.	X5R	0.05 max.	X7R	0.075 max.	X7S	0.10 max.		0.15 max.	For information which product has which Dissipation Factor, please contact with our sales representative.
T. C.	D. F.																
	0.03 max.																
X5R	0.05 max.																
X7R	0.075 max.																
X7S	0.10 max.																
	0.15 max.																

(continued)

No.	Item		Performance	Test or inspection method																				
7	Temperature Characteristics of Capacitance (Class 1)		<table border="1"> <tr> <td colspan="2">Temperature Coefficient (ppm/°C)</td> </tr> <tr> <td colspan="2">COG : 0 ± 30</td> </tr> </table> Capacitance drift Within $\pm 0.2\%$ or $\pm 0.05\text{pF}$, whichever larger.	Temperature Coefficient (ppm/°C)		COG : 0 ± 30		Temperature Coefficient shall be calculated based on values at 25°C and 85°C temperature. Measuring temperature below 20°C shall be -10°C and -25°C																
Temperature Coefficient (ppm/°C)																								
COG : 0 ± 30																								
8	Temperature Characteristics of Capacitance (Class 2)		<table border="1"> <tr> <td colspan="2">Capacitance Change (%)</td> </tr> <tr> <td colspan="2">No voltage applied</td> </tr> <tr> <td>X5R:</td> <td>± 15</td> </tr> <tr> <td>X7R:</td> <td>± 15</td> </tr> <tr> <td>X7S:</td> <td>± 22</td> </tr> </table>	Capacitance Change (%)		No voltage applied		X5R:	± 15	X7R:	± 15	X7S:	± 22	Capacitance shall be measured by the steps shown in the following table, after thermal equilibrium is obtained for each step. ΔC be calculated ref. STEP3 reading. <table border="1"> <thead> <tr> <th>Step</th> <th>Temperature (°C)</th> </tr> </thead> <tbody> <tr> <td>1</td> <td>Reference temp. ± 2</td> </tr> <tr> <td>2</td> <td>Min. operating temp. ± 2</td> </tr> <tr> <td>3</td> <td>Reference temp. ± 2</td> </tr> <tr> <td>4</td> <td>Max. operating temp. ± 2</td> </tr> </tbody> </table> As for the capacitor of rated voltage 10V DC(1A) and 6.3V DC(0J), 0.2Vrms. shall be applied.	Step	Temperature (°C)	1	Reference temp. ± 2	2	Min. operating temp. ± 2	3	Reference temp. ± 2	4	Max. operating temp. ± 2
Capacitance Change (%)																								
No voltage applied																								
X5R:	± 15																							
X7R:	± 15																							
X7S:	± 22																							
Step	Temperature (°C)																							
1	Reference temp. ± 2																							
2	Min. operating temp. ± 2																							
3	Reference temp. ± 2																							
4	Max. operating temp. ± 2																							
9	Lead Strength	Tensile Strength	No mechanical damage such as lead breakage and loosing.	With holding the parts, apply pulling force to lead drawing direction gradually. Pulling strength : 5N Holding time : $10 \pm 1\text{s}$.																				
		Bending Strength	No mechanical damage such as lead breakage and loosing.	With holding the capacitors to keep the axis vertical, bend it 90 degrees with weighting and put it back to the original position. This operation shall be done for 2~3s. and repeat the following times. Bending forth : 5N (weight : 0.51kg) Testing time : 2 times																				
10	Vibration	External appearance	No mechanical damage.	Solder the capacitors on a P. C. Board shown in Appendix1 before testing.																				
		Capacitance	<table border="1"> <thead> <tr> <th colspan="2">Characteristics</th> <th>Change from the value before test</th> </tr> </thead> <tbody> <tr> <td>Class1</td> <td>COG</td> <td>$\pm 2.5\%$ or $\pm 0.25\text{pF}$, whichever larger.</td> </tr> <tr> <td rowspan="3">Class2</td> <td>X5R</td> <td>$\pm 7.5\%$</td> </tr> <tr> <td>X7R</td> <td>$\pm 7.5\%$</td> </tr> <tr> <td>X7S</td> <td>$\pm 7.5\%$</td> </tr> </tbody> </table>	Characteristics		Change from the value before test	Class1	COG	$\pm 2.5\%$ or $\pm 0.25\text{pF}$, whichever larger.	Class2	X5R	$\pm 7.5\%$	X7R	$\pm 7.5\%$	X7S	$\pm 7.5\%$	Vibrate the capacitor with amplitude of 1.5mm P-P changing the frequencies from 10Hz to 55Hz and back to 10Hz in about 1min. Repeat this for 2h each in 3 perpendicular directions.							
			Characteristics		Change from the value before test																			
			Class1	COG	$\pm 2.5\%$ or $\pm 0.25\text{pF}$, whichever larger.																			
Class2	X5R	$\pm 7.5\%$																						
	X7R	$\pm 7.5\%$																						
	X7S	$\pm 7.5\%$																						
Q Class1	Shown in Table2.																							
D. F. Class2	Meet the initial spec.																							

(continued)

No.	Item	Performance	Test or inspection method																								
11	Solderability	Leads shall be covered by new solder more than 75% of its surface.	<p>Completely soak both terminations in solder at $245 \pm 5^\circ\text{C}$ for $2 \pm 0.5\text{s}$.</p> <p>Solder : Sn-3.0Ag-0.5Cu(Pb-free) Flux : Isopropyl alcohol(JIS K 8839) Rosin(JIS K 5902) 25% solid solution. Dipping : By 1.5~2.0mm from the root of lead.</p>																								
12	Resistance to solder heat	External appearance	<p>Completely soak both terminations in solder at $250 \pm 5^\circ\text{C}$ for $5 \pm 1\text{s}$.</p> <p>Solder : Sn-3.0Ag-0.5Cu(Pb-free) Flux : Isopropyl alcohol(JIS K 8839) Rosin(JIS K 5902) 25% solid solution. Dipping : By 1.5~2.0mm from the root of lead.</p>																								
		Capacitance																									
		<table border="1"> <thead> <tr> <th colspan="2">Characteristics</th> <th>Change from the value before test</th> </tr> </thead> <tbody> <tr> <td>Class1</td> <td>COG</td> <td>$\pm 2.5\%$ or $\pm 0.25\text{pF}$ whichever larger.</td> </tr> <tr> <td rowspan="3">Class2</td> <td>X5R</td> <td>$\pm 7.5\%$</td> </tr> <tr> <td>X7R</td> <td>$\pm 7.5\%$</td> </tr> <tr> <td>X7S</td> <td>$\pm 7.5\%$</td> </tr> </tbody> </table>		Characteristics		Change from the value before test	Class1	COG	$\pm 2.5\%$ or $\pm 0.25\text{pF}$ whichever larger.	Class2	X5R	$\pm 7.5\%$	X7R	$\pm 7.5\%$	X7S	$\pm 7.5\%$											
		Characteristics		Change from the value before test																							
		Class1		COG	$\pm 2.5\%$ or $\pm 0.25\text{pF}$ whichever larger.																						
Class2	X5R	$\pm 7.5\%$																									
	X7R	$\pm 7.5\%$																									
	X7S	$\pm 7.5\%$																									
Q Class1	Shown in Table2.																										
D.F. Class2	Meet the initial spec.																										
Insulation Resistance	Meet the initial spec.																										
Voltage proof	No insulation breakdown or other damage.																										
13	Temperature Cycle and Dipping Cycle		<p>Temperature Cycle</p> <table border="1"> <thead> <tr> <th>Step</th> <th>Temp. ($^\circ\text{C}$)</th> <th>Time(min.)</th> </tr> </thead> <tbody> <tr> <td>1</td> <td>Min. operating Temp. ± 3</td> <td>30 ± 3</td> </tr> <tr> <td>2</td> <td>Reference temp.</td> <td>Less than 3</td> </tr> <tr> <td>3</td> <td>Max. operating Temp. ± 3</td> <td>30 ± 3</td> </tr> <tr> <td>4</td> <td>Reference temp.</td> <td>Less than 3</td> </tr> </tbody> </table>	Step	Temp. ($^\circ\text{C}$)	Time(min.)	1	Min. operating Temp. ± 3	30 ± 3	2	Reference temp.	Less than 3	3	Max. operating Temp. ± 3	30 ± 3	4	Reference temp.	Less than 3									
		Step	Temp. ($^\circ\text{C}$)	Time(min.)																							
		1	Min. operating Temp. ± 3	30 ± 3																							
		2	Reference temp.	Less than 3																							
		3	Max. operating Temp. ± 3	30 ± 3																							
4	Reference temp.	Less than 3																									
Capacitance	<table border="1"> <thead> <tr> <th colspan="2">Characteristics</th> <th>Change from the value before test</th> </tr> </thead> <tbody> <tr> <td>Class1</td> <td>COG</td> <td>$\pm 2.5\%$ or $\pm 0.25\text{pF}$ whichever larger.</td> </tr> <tr> <td rowspan="3">*Class2</td> <td>X5R</td> <td>$\pm 7.5\%$</td> </tr> <tr> <td>X7R</td> <td>$\pm 10\%$</td> </tr> <tr> <td>X7S</td> <td>$\pm 10\%$</td> </tr> </tbody> </table> <p>*Applied for some parts</p>	Characteristics		Change from the value before test	Class1	COG	$\pm 2.5\%$ or $\pm 0.25\text{pF}$ whichever larger.	*Class2	X5R	$\pm 7.5\%$	X7R	$\pm 10\%$	X7S	$\pm 10\%$	<p>Dipping Cycle</p> <table border="1"> <thead> <tr> <th>Step</th> <th>Temp. ($^\circ\text{C}$)</th> <th>Time (min.)</th> <th>Solidy liquid</th> </tr> </thead> <tbody> <tr> <td>1</td> <td>$65 \begin{smallmatrix} +5 \\ 0 \end{smallmatrix}$</td> <td>$15 \pm 2$</td> <td>Pure water</td> </tr> <tr> <td>2</td> <td>0 ± 3</td> <td>15 ± 2</td> <td>Saturation salt water</td> </tr> </tbody> </table>	Step	Temp. ($^\circ\text{C}$)	Time (min.)	Solidy liquid	1	$65 \begin{smallmatrix} +5 \\ 0 \end{smallmatrix}$	15 ± 2	Pure water	2	0 ± 3	15 ± 2	Saturation salt water
Characteristics		Change from the value before test																									
Class1	COG	$\pm 2.5\%$ or $\pm 0.25\text{pF}$ whichever larger.																									
*Class2	X5R	$\pm 7.5\%$																									
	X7R	$\pm 10\%$																									
	X7S	$\pm 10\%$																									
Step	Temp. ($^\circ\text{C}$)	Time (min.)	Solidy liquid																								
1	$65 \begin{smallmatrix} +5 \\ 0 \end{smallmatrix}$	15 ± 2	Pure water																								
2	0 ± 3	15 ± 2	Saturation salt water																								
Q Class1	Shown in Table2.	<p>Solder the capacitors on a P.C.Board shown in Appendix1 before testing.</p> <p>Leave the capacitors in ambient condition for the following time before measurement.</p> <p>Class1 : $24 \pm 2\text{h}$ Class2 : $48 \pm 4\text{h}$</p> <p>Perform Temperature cycle(5 cycle) and dipping cycle(2 cycle) consecutively.</p>																									
D.F. Class2	Meet the initial spec.																										
Insulation Resistance	Meet the initial spec.																										
Voltage proof	No insulation breakdown or other damage.																										

(continued)

No.	Item	Performance	Test or inspection method									
14	Moisture Resistance (Steady State)	External appearance	Solder the capacitors on a P.C. Board shown in Appendix1 before testing. Leave at temperature $40 \pm 2^\circ\text{C}$, 90 to 95%RH for 500 +24, 0h. Leave the capacitors in ambient condition for the following time before measurement. Class1 : $24 \pm 2\text{h}$ Class2 : $48 \pm 4\text{h}$									
		Capacitance										
		<table border="1"> <thead> <tr> <th colspan="2">Characteristics</th> <th>Change from the value before test</th> </tr> </thead> <tbody> <tr> <td>Class1</td> <td>COG</td> <td>$\pm 5\%$ or 0.5pF whichever larger.</td> </tr> <tr> <td>*Class2</td> <td>X5R X7R X7S</td> <td>$\pm 12.5\%$ $\pm 25\%$</td> </tr> </tbody> </table>		Characteristics		Change from the value before test	Class1	COG	$\pm 5\%$ or 0.5pF whichever larger.	*Class2	X5R X7R X7S	$\pm 12.5\%$ $\pm 25\%$
		Characteristics		Change from the value before test								
Class1	COG	$\pm 5\%$ or 0.5pF whichever larger.										
*Class2	X5R X7R X7S	$\pm 12.5\%$ $\pm 25\%$										
*Applied for some parts												
	Q Class1	Shown in Table2.										
	D. F. Class2	Characteristics 200% of initial spec max.										
	Insulation Resistance	$1,000\text{M}\Omega$ or $50\text{M}\Omega \cdot \mu\text{F}$ min. (As for the capacitor of rated voltage 16, 10 and 6.3V DC, $1,000\text{M}\Omega$ or $10\text{M}\Omega \cdot \mu\text{F}$ min.,) whichever smaller.										
15	Moisture Resistance	External appearance	Solder the capacitors on a P.C. Board shown in Appendix1 before testing. Apply the rated voltage at temperature $40 \pm 2^\circ\text{C}$ and 90 to 95%RH for 500 +24, 0h. Charge/discharge current shall not exceed 50mA. Leave the capacitors in ambient condition for the following time before measurement. Class1 : $24 \pm 2\text{h}$ Class2 : $48 \pm 4\text{h}$ Voltage conditioning : (Only Class2) Voltage treat the capacitor under testing temperature and voltage for 1hour. Leave the capacitors in ambient condition for $48 \pm 4\text{h}$ before measurement. Use this measurement for initial value.									
		Capacitance										
		<table border="1"> <thead> <tr> <th colspan="2">Characteristics</th> <th>Change from the value before test</th> </tr> </thead> <tbody> <tr> <td>Class1</td> <td>COG</td> <td>$\pm 7.5\%$ or $\pm 0.75\text{pF}$ whichever larger.</td> </tr> <tr> <td>*Class2</td> <td>X5R X7R X7S</td> <td>$\pm 12.5\%$ $\pm 25\%$</td> </tr> </tbody> </table>		Characteristics		Change from the value before test	Class1	COG	$\pm 7.5\%$ or $\pm 0.75\text{pF}$ whichever larger.	*Class2	X5R X7R X7S	$\pm 12.5\%$ $\pm 25\%$
		Characteristics		Change from the value before test								
Class1	COG	$\pm 7.5\%$ or $\pm 0.75\text{pF}$ whichever larger.										
*Class2	X5R X7R X7S	$\pm 12.5\%$ $\pm 25\%$										
*Applied for some parts												
	Q Class1	Shown in Table2.										
	D. F. Class2	Characteristics 200% of initial spec max.										
	Insulation Resistance	$500\text{M}\Omega$ or $25\text{M}\Omega \cdot \mu\text{F}$ min. (As for the capacitor of rated voltage 16, 10 and 6.3V DC, $500\text{M}\Omega$ or $5\text{M}\Omega \cdot \mu\text{F}$ min.,) whichever smaller.										

(continued)

No.	Item	Performance	Test or inspection method														
16	Life	External appearance	No mechanical damage.														
		Capacitance	<table border="1"> <thead> <tr> <th colspan="2">Characteristics</th> <th>Change from the value before test</th> </tr> </thead> <tbody> <tr> <td>Class1</td> <td>COG</td> <td>$\pm 3\%$ or $\pm 0.3\%$ whichever larger.</td> </tr> <tr> <td rowspan="3">*Class2</td> <td>X5R</td> <td>$\pm 15\%$</td> </tr> <tr> <td>X7R</td> <td>$\pm 25\%$</td> </tr> <tr> <td>X7S</td> <td></td> </tr> </tbody> </table>	Characteristics		Change from the value before test	Class1	COG	$\pm 3\%$ or $\pm 0.3\%$ whichever larger.	*Class2	X5R	$\pm 15\%$	X7R	$\pm 25\%$	X7S		<p>Solder the capacitors on a P.C.Board shown in Appendix1 before testing.</p> <p>Below the voltage shall be applied at maximum operating temperature $\pm 2^{\circ}\text{C}$ for 1,000 +48,0h.</p> <hr/> <p>Applied voltage</p> <hr/> <p>Rated voltage $\times 2$</p> <hr/> <p>Rated voltage $\times 1$</p> <hr/> <p>For information which products has which applied voltage, please contact with our sales representative.</p> <p>Charge/discharge current shall not exceed 50mA.</p> <p>Leave the capacitors in ambient condition for the following time before measurement.</p> <p>Class1 : $24 \pm 2\text{h}$ Class2 : $48 \pm 4\text{h}$</p> <p>Voltage conditioning : (Only Class2) Voltage treat the capacitor under testing temperature and voltage for 1hour.</p> <p>Leave the capacitors in ambient condition for $48 \pm 4\text{h}$ before measurement.</p> <p>Use this measurement for initial value.</p>
			Characteristics		Change from the value before test												
			Class1	COG	$\pm 3\%$ or $\pm 0.3\%$ whichever larger.												
			*Class2	X5R	$\pm 15\%$												
X7R	$\pm 25\%$																
X7S																	
Q Class1	Shown in Table2.																
D.F. Class2	characteristics 200% of initial spec max.																
Insulation Resistance	1,000M Ω or 50M $\Omega \cdot \mu\text{F}$ min. (As for the capacitor of rated voltage 16, 10 and 6.3V DC, 1,000 M Ω or 10M $\Omega \cdot \mu\text{F}$ min.,) whichever smaller.																

* As for the initial measurement of capacitors (Class2) on number 8, 10, 12, 13, and 14, leave capacitors at $150 - 10, 0^{\circ}\text{C}$ for 1h and measure the value after leaving capacitors for $48 \pm 4\text{h}$ in ambient condition.

table2

Specification		Applicable numbers of Table1
30pF and over	$Q \geq 1,000$	6, 10, 12, 13
Less than 30pF	$Q \geq 400+20 \cdot C$	
30pF and over	$Q \geq 350$	14, 16
Less than 30pF	$Q \geq 275+5/2 \cdot C$	
30pF and over	$Q \geq 200$	15
Less than 30pF	$Q \geq 100+10/3 \cdot C$	

(Note) : C denotes Rated Capacitance(pF)

Appendix 1

P. C. board

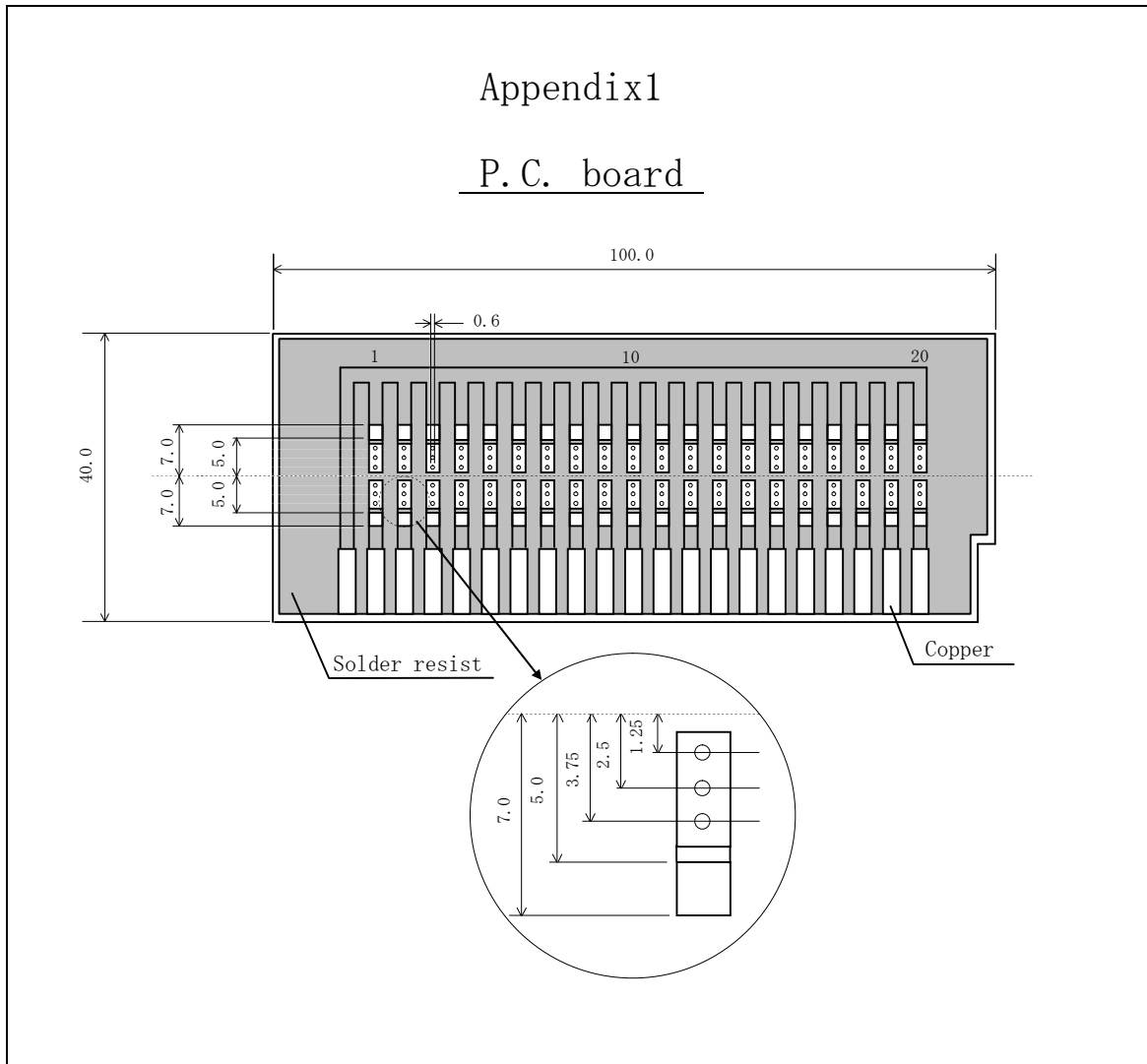

(Unit : mm)

1. Material :Glass Epoxy(As per JIS C6484 GE4)





2. Thickness : 1.6mm

 Copper(Thickness:0.035mm)

 Solder resist

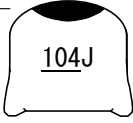
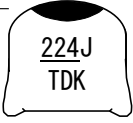
8. INDICATION

8.1 Indication (Example)

T.C.	Type	FK 1 8 FK 2 8	FK 1 4 FK 2 4	FK 1 6 FK 2 6	FK 1 1 FK 2 0	FK 2 2		
	COG	(2) —			(1) — (2) — (4) —		(1) — (2) — (4) —	
X 5 R X 7 R X 7 S	(2) —			(2) — (4) —		(2) — (4) —		—(3) —(5)

8.2 Meaning of indication

Item	Detail	Type		
		FK18, FK14 FK28, FK24	FK16, FK11, FK26, FK20	FK22
(1) T.C.	For COG, indicate Black mark on the head.	—	○	○
(2) Rated Capacitance	Indicate in three digits.	○	○	○
(3) Capacitance tolerance	Indicates the symbol.	—	○	○
(4) Rated voltage	For DC50V, indicate a bar under the rated capacitance.	—	○	○
(5) Manufacturer	Indicates " TDK ".	—	—	○

9. INSIDE STRUCTURE AND MATERIAL

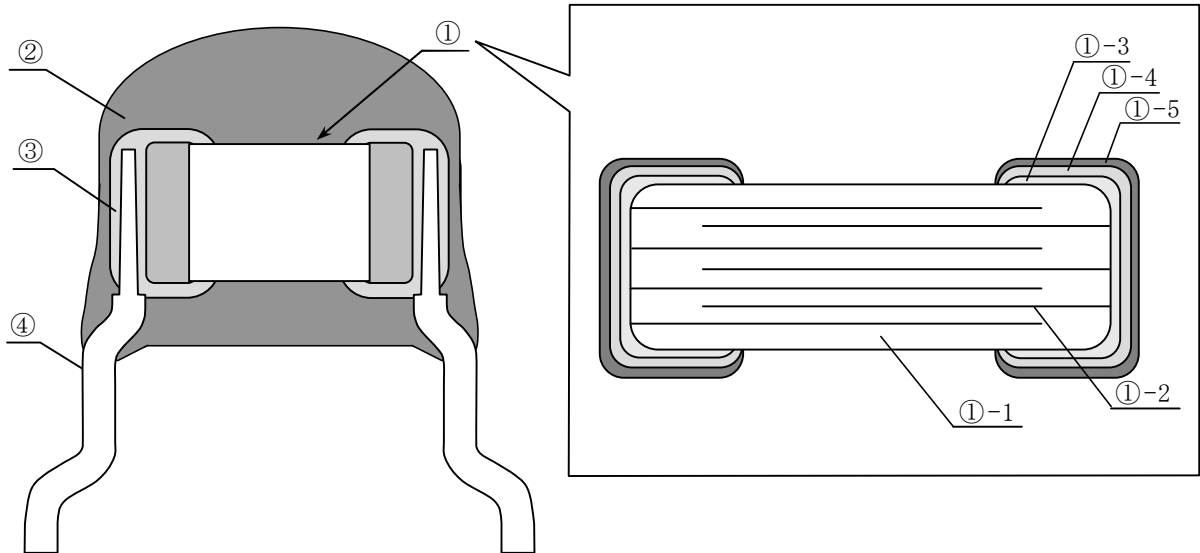

No.	NAME	No.	NAME	MATERIAL	
				Class 1	Class 2
①	Multilayer Ceramic Chip Capacitors	①-1	Dielectric	CaZrO ₃	BaTiO ₃
		①-2	Electrode	Ni	
		①-3	Termination	Cu	
		①-4		Ni	
		①-5		Sn	
②	Coating		Epoxy		
③	Solder for joint		High temp. solder		
④	Lead wire		Solder coated copper wire		

10. PACKAGING

Packaging shall be done to protect the components from the damage during Transportation and storing, and a label which has the following information shall be attached.

- 1) Total number of components in a plastic bag: 500pcs.max.
- 2) Tape packaging is as per TDK tape packaging specification.

- 1) Inspection No. *
- 2) TDK P/N
- 3) Customer' s P/N
- 4) Quantity

* Composition of Inspection No.

Example $\frac{X}{(a)} \frac{3}{(b)} \frac{A}{(c)} - \frac{00}{(d)} - \frac{000}{(e)}$

- a) Line code
- b) Last digit of year
- c) Month and A for January and B for February and so on. (Skip I)
- d) Inspection Date of the month.
- e) Serial No. of the day

11. Caution

No.	Process	Condition
1	Operating Condition (Storage, Transportation)	<p>1-1. Storage</p> <ol style="list-style-type: none"> 1) The capacitor must be stored in an ambient temperature of 5~40°C with a relative humidity of 20~70%. The products should be used within 6 months upon receipt. 2) The capacitors must be operated and stored in an environment free of dew condensation and these gases such as Hydrogen Sulphide, Hydrogen Sulphate, Chlorine, Ammonia and sulfur. 3) Avoid storing in sun light and wet with dew. 4) Do not use capacitors under high humidity and high and low atmospheric pressure which may affect capacitors reliability. 5) Capacitors should be tested for the solderability when they are stored for long time. <p>1-2. Handling in transportation</p> <ol style="list-style-type: none"> 1) In case of the transportation of the capacitors, the performance of the capacitors may be deteriorated depending on the transportation condition. (Refer to JEITA RCR-2335B 9.2 Handling in transportation)
2	Circuit design  Caution	<p>2-1. Operating temperature</p> <p>Operating temperature should be followed strictly within this specification, especially be careful with the maximum temperature.</p> <ol style="list-style-type: none"> 1) Do not use capacitor above the maximum allowable operating temperature. 2) Surface temperature including self heating should be below maximum operating temperature. (Due to dielectric loss, capacitor will heat itself when AC is applied. Especially at high frequencies around its SRF, the heat might be so extreme that it may damage itself or the product mounted on. Please design the circuit so that the maximum temperature of the capacitor including the self heating to be below the maximum allowable operating temperature. Temperature rise shall be bellow 20°C.) 3) The electrical characteristics of the capacitors will vary depending on the temperature. The capacitors should be selected and designed in taking the temperature into consideration. <p>2-2. Operating voltage</p> <ol style="list-style-type: none"> 1) Operating voltage across the terminals should be below the rated voltage. When AC and DC are super imposed, V_{0-P} must be below the rated voltage. ———— (1) and (2) AC or pulse with overshooting, V_{p-p} must be below the rated voltage. ———— (3), (4) and (5) When the voltage is started to apply to the circuit or it is stopped applying, the irregular voltage may be generated for a transit period because of resonance or switching. Be sure to use a capacitor within rated voltage containing these irregular voltage.

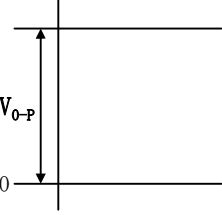
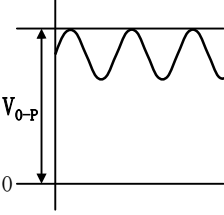
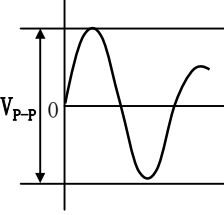
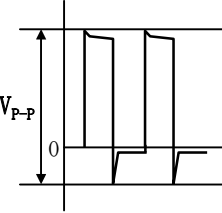
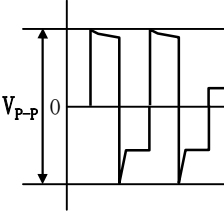
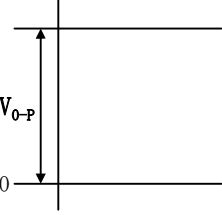
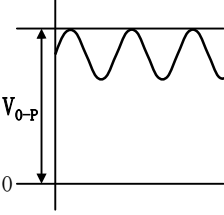
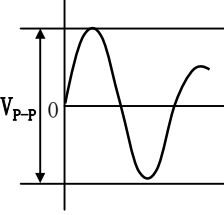
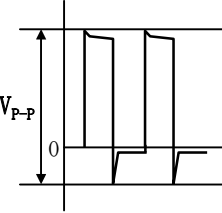
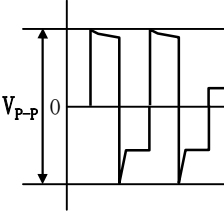
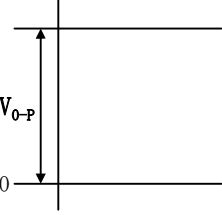
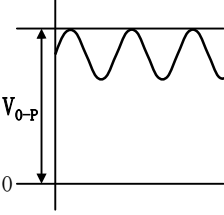
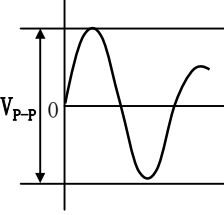
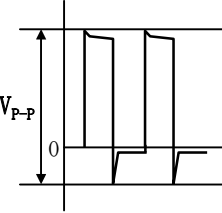
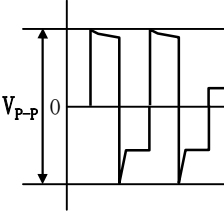
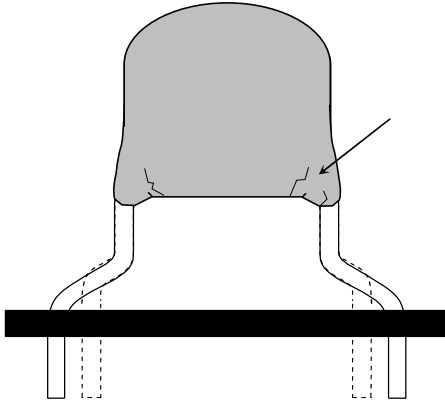
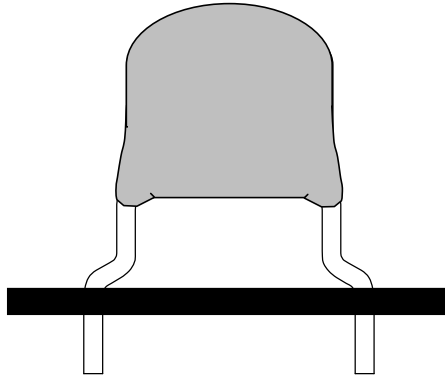
No.	Process	Condition																		
2	Circuit design  Caution	<table border="1" data-bbox="459 212 1422 784"> <thead> <tr> <th data-bbox="459 212 646 246">Voltage</th> <th data-bbox="646 212 901 246">(1) DC voltage</th> <th data-bbox="901 212 1161 246">(2) DC+AC voltage</th> <th data-bbox="1161 212 1422 246">(3) AC voltage</th> </tr> </thead> <tbody> <tr> <td data-bbox="459 246 646 481">Positional Measurement (Rated voltage)</td> <td data-bbox="646 246 901 481">  </td> <td data-bbox="901 246 1161 481">  </td> <td data-bbox="1161 246 1422 481">  </td> </tr> <tr> <th data-bbox="459 515 646 548">Voltage</th> <th data-bbox="646 515 901 548">(4) Pulse voltage (A)</th> <th data-bbox="901 515 1161 548">(5) Pulse voltage (B)</th> <th colspan="2"></th> </tr> <tr> <td data-bbox="459 548 646 784">Positional Measurement (Rated voltage)</td> <td data-bbox="646 548 901 784">  </td> <td data-bbox="901 548 1161 784">  </td> <td colspan="2"></td> </tr> </tbody> </table> <p data-bbox="451 817 1444 884">2) Even below the rated voltage, if repetitive high frequency AC or pulse is applied, the reliability of the capacitor may be reduced.</p> <p data-bbox="451 918 1444 1019">3) The effective capacitance will vary depending on applied DC and AC voltages. The capacitors should be selected and designed in taking the voltages into consideration.</p> <p data-bbox="427 1052 614 1086">2-3. Frequency</p> <p data-bbox="451 1086 1412 1153">1) When the capacitors (Class 2) are used in AC and/or pulse voltages, the capacitors may vibrate themselves and generate audible sound.</p>	Voltage	(1) DC voltage	(2) DC+AC voltage	(3) AC voltage	Positional Measurement (Rated voltage)				Voltage	(4) Pulse voltage (A)	(5) Pulse voltage (B)			Positional Measurement (Rated voltage)				
Voltage	(1) DC voltage	(2) DC+AC voltage	(3) AC voltage																	
Positional Measurement (Rated voltage)																				
Voltage	(4) Pulse voltage (A)	(5) Pulse voltage (B)																		
Positional Measurement (Rated voltage)																				
3	Designing P.C. board	<p data-bbox="427 1187 1460 1288">If capacitor leads are inserted into different pitch holes, it may induce excessive stress in the capacitor or outer resin to result in cracking, and it may degrade the quality.</p> <p data-bbox="427 1288 981 1321">Recommend capacitor layout is as following.</p> <div data-bbox="491 1355 1428 1803" style="text-align: center;"> <p data-bbox="614 1355 821 1388">Not recommended</p>  <p data-bbox="1125 1355 1252 1388">Recommend</p>  </div>																		

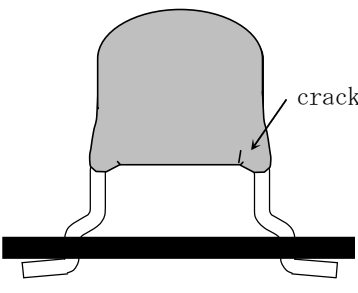
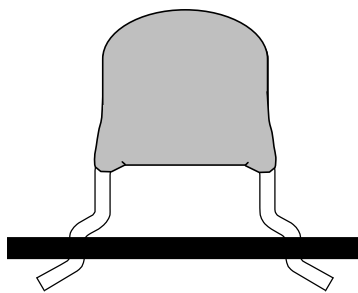
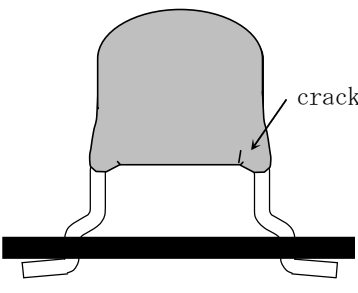
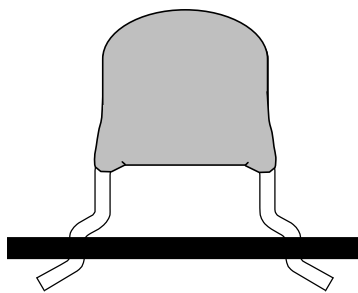
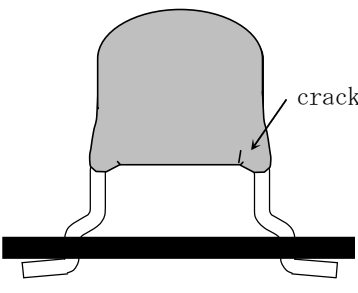
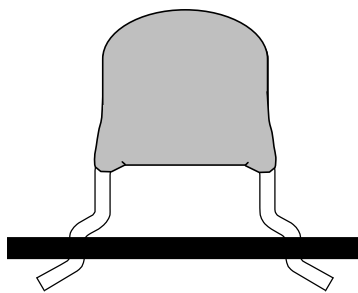
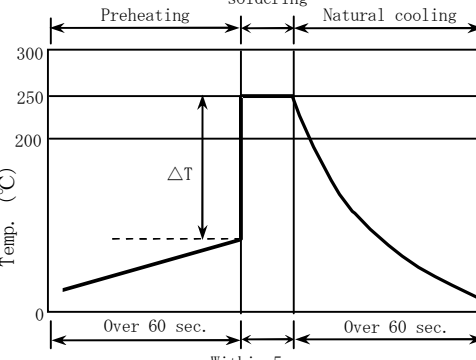
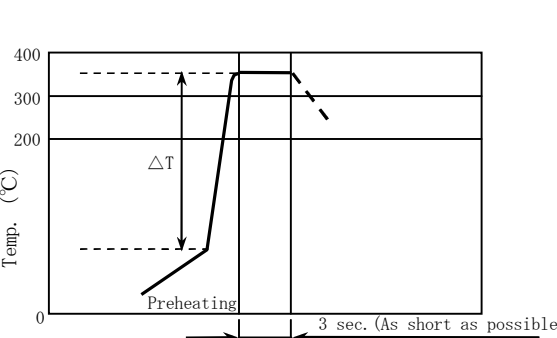
No.	Process	Condition						
4	Lead wire insertion	<p>1) If the leads clinching is too tight, the lead wire tend to be pulled excessively to cause lead wire breakage or cracking of the coating and quality degradation. Please adjust the clinching and provide sufficient preventive maintenance. Recommended capacitor layout is as following.</p> <table border="1" data-bbox="406 313 1396 660"> <thead> <tr> <th data-bbox="406 313 558 347"></th> <th data-bbox="558 313 981 347">Not recommended</th> <th data-bbox="981 313 1396 347">Recommended</th> </tr> </thead> <tbody> <tr> <td data-bbox="406 481 558 515">Clinching</td> <td data-bbox="558 347 981 660">  </td> <td data-bbox="981 347 1396 660">  </td> </tr> </tbody> </table> <p>2) If capacitor leads are inserted into different pitch holes, it may induce excessive stress in the capacitor or outer resin to result in cracking, and it may degrade the quality. When the lead pitch does not fit with the through hole on the pc board, please adjust the lead pitch so that the capacitor body would not receive excessive force.</p>		Not recommended	Recommended	Clinching		
	Not recommended	Recommended						
Clinching								
5	Soldering	<p>5-1. Flux selection Although highly-activated flux gives better solderability, substances which increase activity may also degrade the insulation of the capacitors. To avoid such degradation, it is recommended following.</p> <ol style="list-style-type: none"> 1) It is recommended to use a mildly activated rosin flux (less than 0.1wt% chlorine). Do not use acidic flux is not recommended. 2) Excessive flux must be avoided. Please provide proper amount of flux. 3) When water-soluble flux is used, enough washing is necessary. <p>5-2. Recommended soldering profile by various methods</p> <div style="display: flex; justify-content: space-around;"> <div data-bbox="375 1310 869 1736"> <p style="text-align: center;">Flow soldering</p>  </div> <div data-bbox="885 1310 1460 1713"> <p style="text-align: center;">Manual soldering (Solder iron)</p>  </div> </div> <p>5-3. Avoiding thermal shock</p> <ol style="list-style-type: none"> 1) Preheating condition <table border="1" data-bbox="558 1825 1125 1960"> <thead> <tr> <th data-bbox="558 1825 837 1870">Soldering</th> <th data-bbox="837 1825 1125 1870">Temp. (°C)</th> </tr> </thead> <tbody> <tr> <td data-bbox="558 1870 837 1915">Wave soldering</td> <td data-bbox="837 1870 1125 1915">$\Delta T \leq 150$</td> </tr> <tr> <td data-bbox="558 1915 837 1960">Manual soldering</td> <td data-bbox="837 1915 1125 1960">$\Delta T \leq 190$</td> </tr> </tbody> </table>	Soldering	Temp. (°C)	Wave soldering	$\Delta T \leq 150$	Manual soldering	$\Delta T \leq 190$
Soldering	Temp. (°C)							
Wave soldering	$\Delta T \leq 150$							
Manual soldering	$\Delta T \leq 190$							

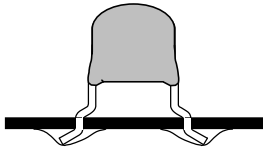
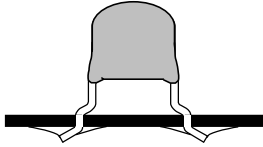
No.	Process	Condition								
5	Soldering	<p>2) Cooling condition Natural cooling using air is recommended. If the chips are dipped into a solvent for cleaning, the temperature difference(ΔT) must be less than 100°C.</p> <p>5-4. Amount of solder In sufficient solder may detach the capacitor from the P.C. board. See bellow for example of solder amount.</p> <hr/> <div style="display: flex; justify-content: space-around; align-items: center;"> <div style="text-align: center;"> <p>Adequate</p>  </div> <div style="text-align: center;"> <p>Insufficient solder</p>  </div> <div style="text-align: center;"> <p>Low robustness may cause contact failure or capacitor comes off the P.C. board.</p> </div> </div> <hr/> <p>5-5. Solder repair by solder iron Tip temperature of solder iron varies by its type, P.C. board material and solder land size. Higher the tip temperature, quick the operation is, but the heat shock may crack the capacitor. Following condition is recommended.</p> <p style="text-align: center;">(Recommended solder iron condition)</p> <table border="1" style="margin-left: auto; margin-right: auto;"> <thead> <tr> <th data-bbox="480 952 699 996">Temp. (°C)</th> <th data-bbox="699 952 916 996">Wattage (W)</th> <th data-bbox="916 952 1134 996">Shape (mm)</th> <th data-bbox="1134 952 1353 996">Time (sec.)</th> </tr> </thead> <tbody> <tr> <td data-bbox="480 996 699 1048" style="text-align: center;">350 MAX.</td> <td data-bbox="699 996 916 1048" style="text-align: center;">20 MAX.</td> <td data-bbox="916 996 1134 1048" style="text-align: center;">ϕ 3.0 MAX.</td> <td data-bbox="1134 996 1353 1048" style="text-align: center;">3 MAX.</td> </tr> </tbody> </table>	Temp. (°C)	Wattage (W)	Shape (mm)	Time (sec.)	350 MAX.	20 MAX.	ϕ 3.0 MAX.	3 MAX.
Temp. (°C)	Wattage (W)	Shape (mm)	Time (sec.)							
350 MAX.	20 MAX.	ϕ 3.0 MAX.	3 MAX.							
6	Cleaning	<p>1) If an unsuitable cleaning fluid is used, flux residue or some foreign articles may stick to capacitor surface to deteriorate especially the insulation resistance.</p> <p>2) If cleaning condition is not suitable, it may damage the capacitor.</p> <p>2)-1. Insufficient washing</p> <ol style="list-style-type: none"> (1) Terminal electrodes may corrode by Halogen in the flux. (2) Halogen in the flux may adhere on the surface of capacitor, and lower the insulation resistance. (3) Water soluble flux has higher tendency to have above mentioned problems (1) and (2). <p>2)-2. Excessive washing</p> <ol style="list-style-type: none"> (1) Excessive washing way damage the coating material of coated capacitor and deteriorate it. (2) When ultrasonic cleaning is used, excessively high ultrasonic energy output can affect the adhesion between the ceramic dielectric and the terminal electrodes. To avoid this, following is the recommended condition. <p style="margin-left: 40px;">Power : 20W/ℓ max. Frequency : 40kHz max. Washing time : 5 minutes max.</p> <p>2)-3. If the cleaning fluid is contaminated, density of Halogen increases, and it may bring the same result as insufficient cleaning.</p>								

No.	Process	Condition
7	Coating and molding of the P. C. board	<p>1) When the P. C. board is coated, please verify the quality influence on the product.</p> <p>2) Please verify carefully that there is no harmful decomposing or reaction gas emission during curing which may damage the capacitor.</p> <p>3) Please verify the curing temperature.</p>
8	Lead wire bending	<p>During lead wire bending process, mechanical stress often concentrates in one part of capacitor body and it may damage the ceramic and the coating. Refer to following for bending the lead wire.</p> <div data-bbox="746 584 1142 1003" data-label="Image"> </div> <p>When bending the lead wire, hold the wire closer to the capacitor with a fixture so that the lead bending would not affect the capacitor body.</p>
9	Handling of loose capacitor	<p>If dropped the capacitor may crack. Once dropped do not use it. Especially, the large case sized capacitor is tendency to have cracks easily, so please handle with care.</p> <div data-bbox="703 1249 1209 1720" data-label="Image"> </div>
10	Capacitance aging	<p>The capacitors (Class 2) have aging in the capacitance. They may not be used in precision time constant circuit. In case of the time constant circuit, the evaluation should be done well.</p>

No.	Process	Condition
11	Estimated life and estimated failure rate of capacitors	<p>The estimated life and the estimated failure rate depend on the temperature and the voltage. This can be calculated by the equation described in JEITA RCR-2335B Annex F(Informative) Calculation of the estimated lifetime and the estimated failure rate (Temperature acceleration : 3rd powered low, Voltage acceleration : 10degC law)</p> <p>The failure rate can be decreased by reducing the temperature and the voltage but they will not be guaranteed.</p>
12	<p>Others</p> <p> Caution</p>	<p>The products listed on this specification sheet are intended for use in general electronic equipment (AV equipment, telecommunications equipment, home appliances, amusement equipment, computer equipment, personal equipment, office equipment, measurement equipment, industrial robots) under a normal operation and use condition.</p> <p>The products are not designed or warranted to meet the requirements of the applications listed below, whose performance and/or quality require a more stringent level of safety or reliability, or whose failure, malfunction or trouble could cause serious damage to society, person or property. Please understand that we are not responsible for any damage or liability caused by use of the products in any of the applications below or for any other use exceeding the range or conditions set forth in this specification sheet.</p> <p>Aerospace/Aviation equipment. Transportation equipment (cars, electric trains, ships, etc.) Medical equipment. Power-generation control equipment. Atomic energy-related equipment. Seabed equipment. Transportation control equipment. Public information-processing equipment. Military equipment. Electric heating apparatus, burning equipment. Disaster prevention/crime prevention equipment. Safety equipment. Other applications that are not considered general-purpose applications.</p> <p>When using this product in general-purpose applications, you are kindly requested to take into consideration securing protection circuit/equipment or providing backup circuits, etc., to ensure higher safety.</p>

TAPE PACKAGING SPECIFICATION

1. CONSTRUCTION AND DIMENSION OF TAPING

Dimensions of FK1* type shall be according to Appendix 2.

Dimensions of FK2* type shall be according to Appendix 3.

2. QUANTITY

Type	Parts quantity/box (pcs.)
FK18, FK28 FK14, FK24 FK16, FK26	2,000
FK11, FK20 FK22	1,500

3. PERFORMANCE SPECIFICATIONS

3-1. The missing of components shall be within consecutive 3pcs.

3-2. Empty part for min 3pcs shall be provided at the beginning and the end of taping.

3-3. Shipping label must be attached at the side of carton.

3-4. When pull the carrier tape for left side with keeping the head of capacitors to the direction of the above figure, adhesive tape shall be upper side.

3-5. Folded tape shall contain 25pcs. of components.

Appendix 2

Taping dimensions

(FK18, FK14, FK16, FK11)

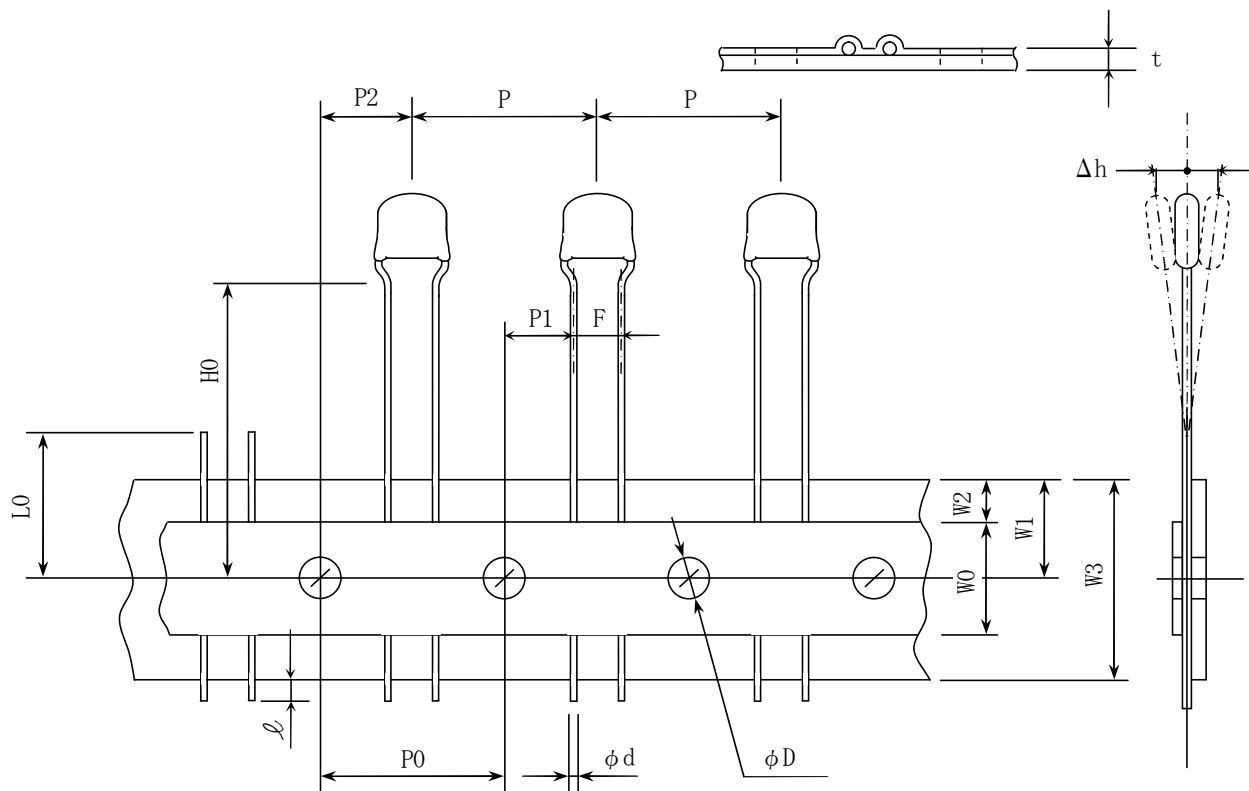

(Unit : mm)

Symbol	Dimensions	Tolerance
P	12.7	±1.0
P0 ※1	12.7	±0.3
P1	5.1	±0.7
P2	6.35	±1.3
W0	12.0	±1.0
W1	9.0	±0.5
W2 ※2	3.0	3.0 and under
W3	18.0	+1.0, -0.5
H0	16.0	±0.5
l	1.0	1.0 and under
t	0.6	±0.2
L0	11.0	11.0 and under
F	2.5	+0.5, -0.2
φd	φ0.5	+0.1, -0.03
φD	φ4.0	±0.2
Δh	—	±2

※1 Accumulated pitch tolerance shall be ±2mm for 20 pitches.

※2 Adhesive tape shall not stick out from carrier tape.

Appendix 3

Taping dimensions

(FK28, FK24, FK26, FK20, FK22)

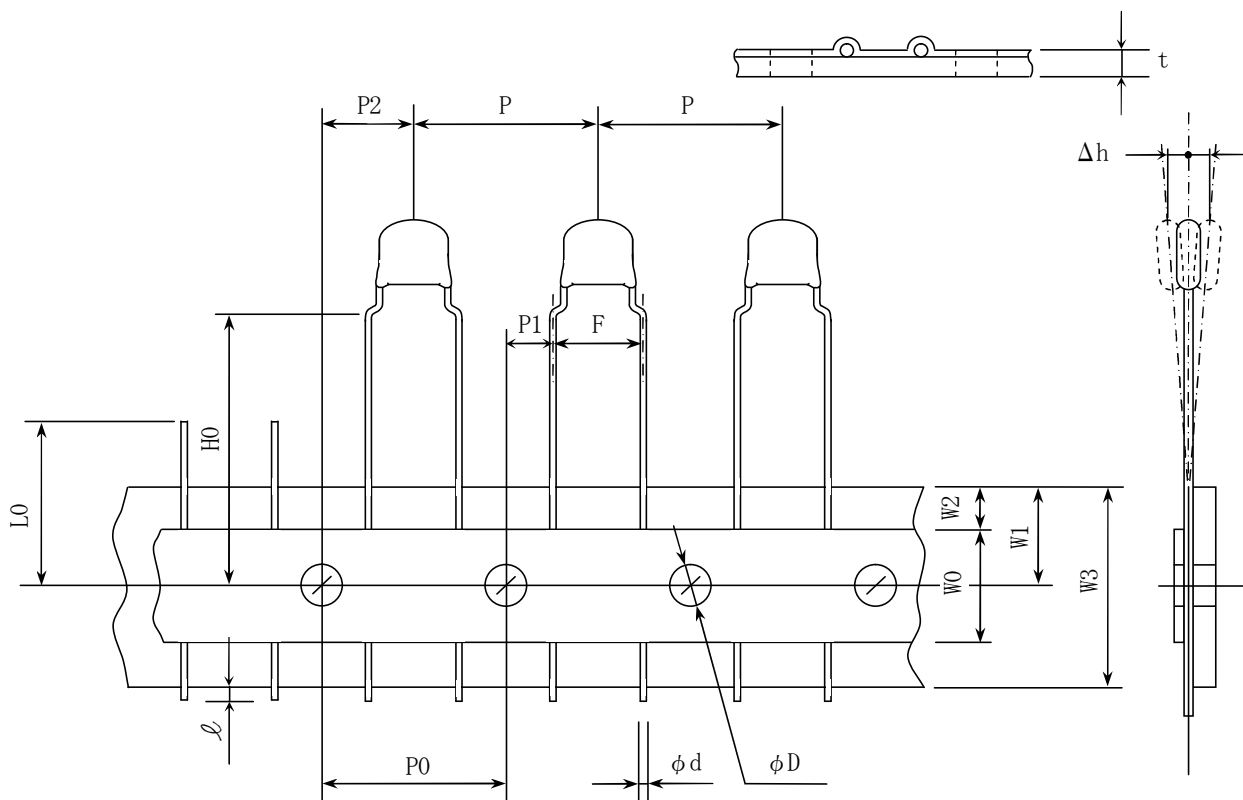

(Unit : mm)

Symbol	Dimensions	Tolerance
P	12.7	±1.0
P0 ※1	12.7	±0.3
P1	3.85	±0.7
P2	6.35	±1.3
W0	12.0	±1.0
W1	9.0	±0.5
W2 ※2	3.0	3.0 and under
W3	18.0	+1.0, -0.5
H0	16.0	±0.5
l	1.0	1.0 and under
t	0.6	±0.2
L0	11.0	11.0 and under
F	5.0	+0.8, -0.2
φd	φ0.5	+0.1, -0.03
φD	φ4.0	±0.2
Δh	—	±2

※1 Accumulated pitch tolerance shall be ±2mm for 20 pitches.

※2 Adhesive tape shall not stick out from carrier tape.