



Chip Beads

For signal line

MMZ series

MMZ0402	0402[01005 inch]*
MMZ0603	0603[0201 inch]
MMZ1005	1005[0402 inch]
MMZ1608	1608[0603 inch]
MMZ2012	2012[0805 inch]

* Dimensions Code JIS[EIA]

REMINDERS FOR USING THESE PRODUCTS

Before using these products, be sure to request the delivery specifications.

SAFETY REMINDERS

Please pay sufficient attention to the warnings for safe designing when using these products.

REMINDERS

- The storage period is less than 12 months. Be sure to follow the storage conditions (Temperature: 5 to 40°C, Humidity: 10 to 75% RH or less).
If the storage period elapses, the soldering of the terminal electrodes may deteriorate.
- Do not use or store in locations where there are conditions such as gas corrosion (salt, acid, alkali, etc.).
- Before soldering, be sure to preheat components.
The preheating temperature should be set so that the temperature difference between the solder temperature and chip temperature does not exceed 150°C.
- Soldering corrections after mounting should be within the range of the conditions determined in the specifications.
If overheated, a short circuit, performance deterioration, or lifespan shortening may occur.
- When embedding a printed circuit board where a chip is mounted to a set, be sure that residual stress is not given to the chip due to the overall distortion of the printed circuit board and partial distortion such as at screw tightening portions.
- Self heating (temperature increase) occurs when the power is turned ON, so the tolerance should be sufficient for the set thermal design.
- Carefully lay out the coil for the circuit board design of the non-magnetic shield type.
A malfunction may occur due to magnetic interference.
- Use a wrist band to discharge static electricity in your body through the grounding wire.
- Do not expose the products to magnets or magnetic fields.
- Do not use for a purpose outside of the contents regulated in the delivery specifications.
- The products listed on this catalog are intended for use in general electronic equipment (AV equipment, telecommunications equipment, home appliances, amusement equipment, computer equipment, personal equipment, office equipment, measurement equipment, industrial robots) under a normal operation and use condition.
The products are not designed or warranted to meet the requirements of the applications listed below, whose performance and/or quality require a more stringent level of safety or reliability, or whose failure, malfunction or trouble could cause serious damage to society, person or property.
If you intend to use the products in the applications listed below or if you have special requirements exceeding the range or conditions set forth in the each catalog, please contact us.

- (1) Aerospace/Aviation equipment
- (2) Transportation equipment (cars, electric trains, ships, etc.)
- (3) Medical equipment
- (4) Power-generation control equipment
- (5) Atomic energy-related equipment
- (6) Seabed equipment
- (7) Transportation control equipment

- (8) Public information-processing equipment
- (9) Military equipment
- (10) Electric heating apparatus, burning equipment
- (11) Disaster prevention/crime prevention equipment
- (12) Safety equipment
- (13) Other applications that are not considered general-purpose applications

When designing your equipment even for general-purpose applications, you are kindly requested to take into consideration securing protection circuit/device or providing backup circuits in your equipment.

Chip Beads

For signal line

Product compatible with RoHS directive

Halogen-free

Compatible with lead-free solders

Overview of the MMZ Series

FEATURES

- Noise reduction solution for general signal lines.
- Lineup includes 5 sizes from 0402 to 2012.
- Achieves various frequency characteristics by using 8 materials with different features.
- Multilayer integration monolithic structure makes it highly reliable.
- There is no directivity.

APPLICATION

- Smart phones, tablets, portable memory audio devices, various modules, PCs, note PCs, TVs, STBs, Blu-ray recorders, DSCs, and DVCs
- Signal line noise removal for game machines, smart grids, industrial equipment, etc.

PART NUMBER CONSTRUCTION

Series name	LxWxT Dimensions (mm)	Material name	Impedance (Ω) at 100MHz	Characteristic type	Packaging style	Internal code
MMZ	0402	S	121	C	T	□□□
	0603	B	120	A	Taping	
	1005	D		B		
	1608	F		H		
	1.6x0.8x0.6	Q				
	1.6x0.8x0.8	R				
	2012	S				
	2.0x1.25x0.85	Y				

OPERATING TEMPERATURE RANGE, PACKAGE QUANTITY, PRODUCT WEIGHT

Type	Temperature range		Package quantity	Individual weight
	Operating temperature*	Storage temperature**		
	(°C)	(°C)	(pieces/reel)	(mg)
MMZ0402	-55 to +125	-55 to +125	20,000	0.08
MMZ0603	-55 to +125	-55 to +125	15,000	0.3
MMZ1005	-55 to +125	-55 to +125	10,000	1
MMZ1608	t=0.6mm	-55 to +125	4,000	3
	t=0.8mm	-55 to +125	4,000	4
MMZ2012	-55 to +125	-55 to +125	4,000	8

* Operating temperature range includes self-temperature rise.

** The Storage temperature range is for after the circuit board is mounted.

- RoHS Directive Compliant Product: See the following for more details related to RoHS Directive compliant products. <http://www.tdk.co.jp/rohs/>
- Halogen-free: Indicates that Cl content is less than 900ppm, Br content is less than 900ppm, and that the total Cl and Br content is less than 1500ppm.

• All specifications are subject to change without notice.

Overview of the MMZ Series

RECOMMENDED REFLOW PROFILE



Preheating			Soldering		Peak	
Temp.	Temp.	Time	Temp.	Time	Temp.	Time
T1	T2	t1	T3	t2	T4	t3
150°C	180°C	60 to 120s	230°C	30 to 60s	250 to 260°C	10s

Overview of the MMZ Series

MATERIAL CHARACTERISTICS

- B material:** This type is perfectly suited for fast digital signals. By equalizing R components and X components that beads possess at a frequency of 5MHz, it is able to suppress overshooting, undershooting and ringing of fast digital signals.
- R material:** For wide frequency applications calling for broad impedance characteristics. For digital signal line applications calling requiring good waveform integrity. Impedance values selected for effectiveness at 10 to 200MHz.
- S material:** Standard type that features impedance characteristics similar to those of a typical ferrite core. For signal line applications in which the blocking region is near 100MHz. Impedance values selected for effectiveness at 40 to 300MHz.
- Y material:** High frequency range type intended for the 100MHz region and above.
For signal line applications in which the signal frequency is far from the cutoff frequency. Impedance values selected for effectiveness at 80 to 400MHz.
- A material:** This high-impedance product is based on the impedance frequency characteristics of our Y-material. The product offers excellent impedance characteristics, which is greater than 2500Ω, in the vicinity of 100MHz range (MMZ1608A252B).
- Q material:** For high-band applications designed for 100MHz and above. Impedance values selected for effectiveness at 100 to 800MHz.
- D material:** For applications calling for low insertion loss at low frequencies and sharply increasing impedance at high frequencies. Designed for high impedance at high frequencies (300MHz to 1GHz) for signal line applications.
- F material:** This new product inherits the characteristic of our D-material, namely its sharp impedance rise time, and its impedance peak frequency has been shifted higher into range. The product offers excellent noise suppression from 600MHz to as high as in the GHz range.

TYPICAL MATERIAL IMPEDANCE CHARACTERISTICS

MMZ0402 Type



MMZ1608 Type

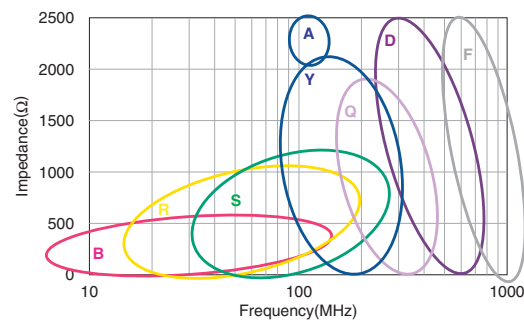

MMZ0603 Type



MMZ2012 Type

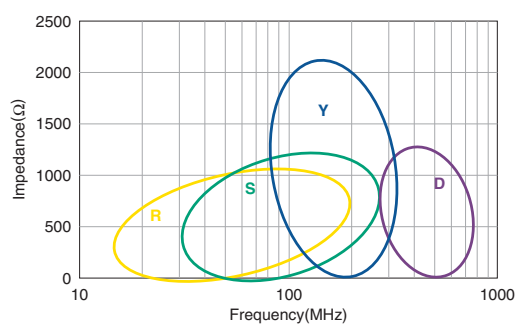

MMZ1005 Type

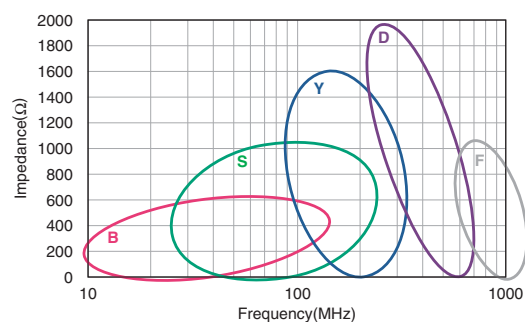

• All specifications are subject to change without notice.

MMZ series

MMZ0402 Type



■ SHAPE & DIMENSIONS

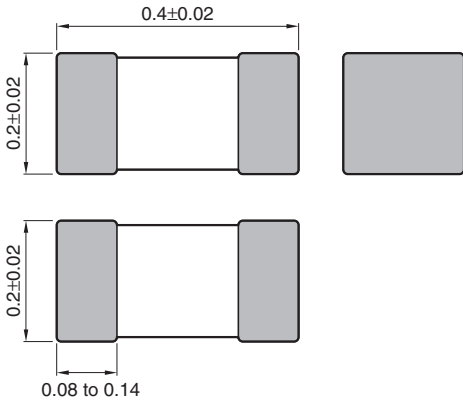

Dimensions in mm

■ RECOMMENDED LAND PATTERN

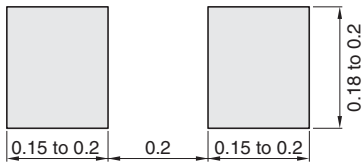

Dimensions in mm

• All specifications are subject to change without notice.

MMZ series **MMZ0402 Type**

■ ELECTRICAL CHARACTERISTICS

□ CHARACTERISTICS SPECIFICATION TABLE

Impedance [100MHz] (Ω)	Tolerance	DC resistance (Ω)max.	Rated current (mA)max.	Part No.
10	$\pm 5\Omega$	0.07	750	MMZ0402S100CT□□□
70	$\pm 25\%$	0.36	300	MMZ0402S700CT□□□
120	$\pm 25\%$	0.70	210	MMZ0402S121CT□□□
150	$\pm 25\%$	0.70	200	MMZ0402S151CT□□□

○ Measurement equipment

Measurement item	Product No.	Manufacturer
Impedance	E4991A+16196D	Agilent Technologies
DC resistance	Type-7556	Yokogawa

* Equivalent measurement equipment may be used.

MMZ series **MMZ0402 Type**

■ ELECTRICAL CHARACTERISTICS

□ Z VS. FREQUENCY CHARACTERISTICS (BY SERIES)

MMZ0402S SERIES

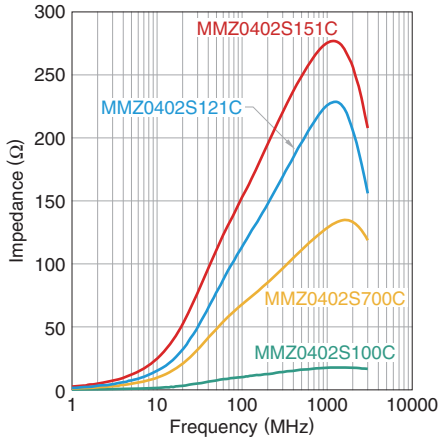

• All specifications are subject to change without notice.

MMZ series MMZ0402 Type

ELECTRICAL CHARACTERISTICS

Z, X, R VS. FREQUENCY CHARACTERISTICS

MMZ0402S100C

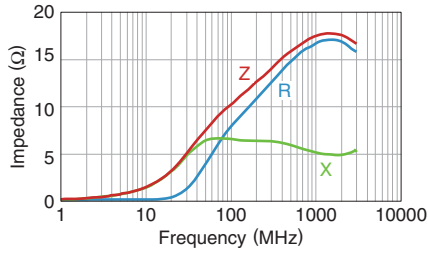

MMZ0402S700C

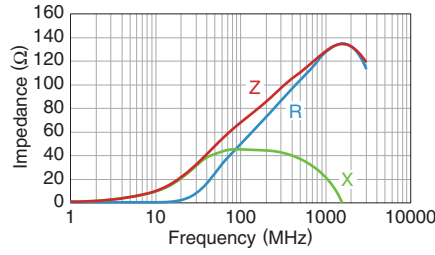

MMZ0402S121C

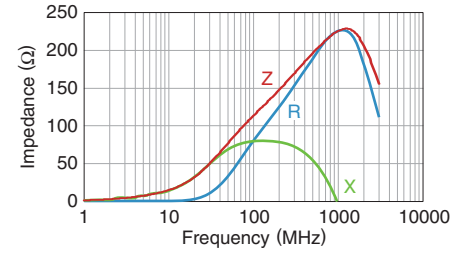

MMZ0402S151C

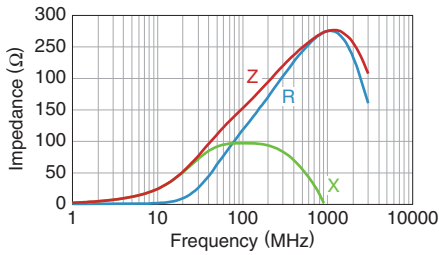

• All specifications are subject to change without notice.

MMZ series

MMZ0603 Type



■ SHAPE & DIMENSIONS

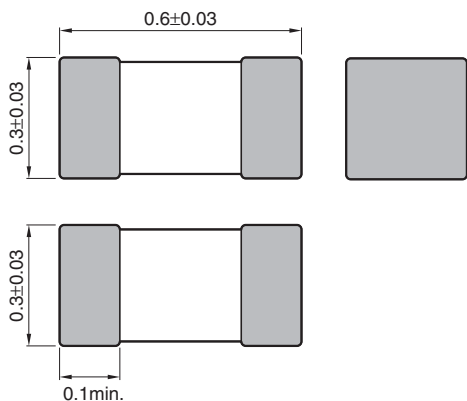

Dimensions in mm

■ RECOMMENDED LAND PATTERN

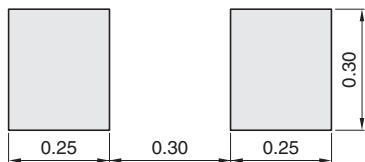

Dimensions in mm

• All specifications are subject to change without notice.

MMZ series MMZ0603 Type

ELECTRICAL CHARACTERISTICS

CHARACTERISTICS SPECIFICATION TABLE

Impedance [100MHz] (Ω)	Tolerance	DC resistance (Ω)max.	Rated current (mA)max.	Part No.
10	$\pm 5\Omega$	0.09	500	MMZ0603S100CT□□□
80	$\pm 25\%$	0.30	200	MMZ0603S800CT□□□
120	$\pm 25\%$	0.45	200	MMZ0603S121CT□□□
240	$\pm 25\%$	0.57	200	MMZ0603S241CT□□□
470	$\pm 25\%$	1.30	100	MMZ0603S471CT□□□
600	$\pm 25\%$	1.45	100	MMZ0603S601CT□□□
1000	$\pm 25\%$	1.25	200	MMZ0603S102HT□□□
75	$\pm 25\%$	0.35	300	MMZ0603Y750CT□□□
120	$\pm 25\%$	0.39	200	MMZ0603Y121CT□□□
240	$\pm 25\%$	0.80	200	MMZ0603Y241CT□□□
470	$\pm 25\%$	1.40	200	MMZ0603Y471CT□□□
600	$\pm 25\%$	1.50	200	MMZ0603Y601CT□□□
33	$\pm 25\%$	0.70	200	MMZ0603D330CT□□□
47	$\pm 25\%$	0.70	200	MMZ0603D470CT□□□
56	$\pm 25\%$	0.95	100	MMZ0603D560CT□□□
80	$\pm 25\%$	1.25	100	MMZ0603D800CT□□□
10	$\pm 5\Omega$	0.50	200	MMZ0603F100CT□□□
22	$\pm 25\%$	1.00	200	MMZ0603F220CT□□□
33	$\pm 25\%$	1.30	150	MMZ0603F330CT□□□

○ Measurement equipment

Measurement item	Product No.	Manufacturer
Impedance	E4991A+16197	Agilent Technologies
DC resistance	Type-7556	Yokogawa

* Equivalent measurement equipment may be used.

MMZ series **MMZ0603 Type**

■ ELECTRICAL CHARACTERISTICS

□ Z VS. FREQUENCY CHARACTERISTICS (BY SERIES)

MMZ0603S SERIES

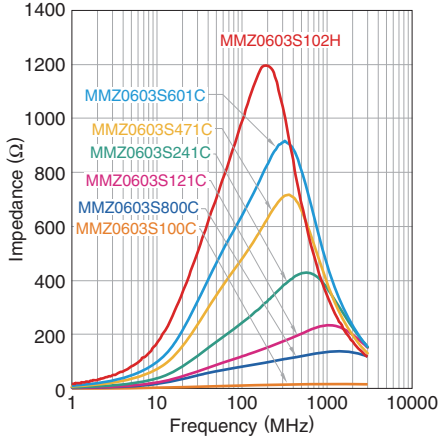

MMZ0603Y SERIES

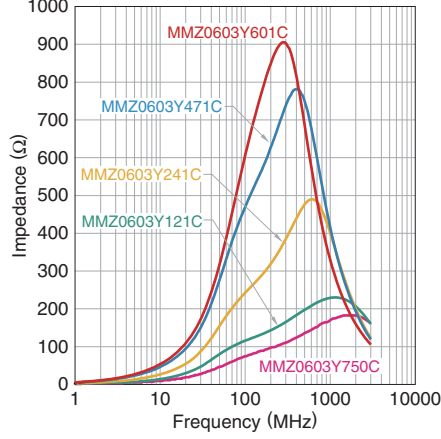

MMZ0603D SERIES

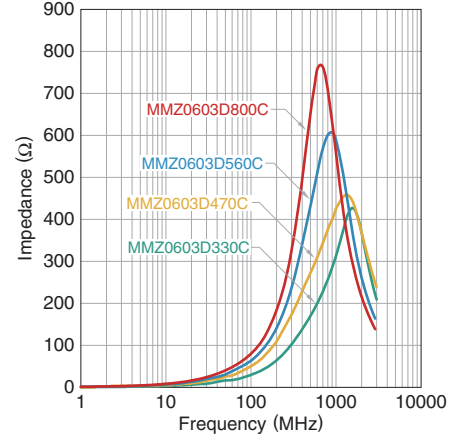

MMZ0603F SERIES

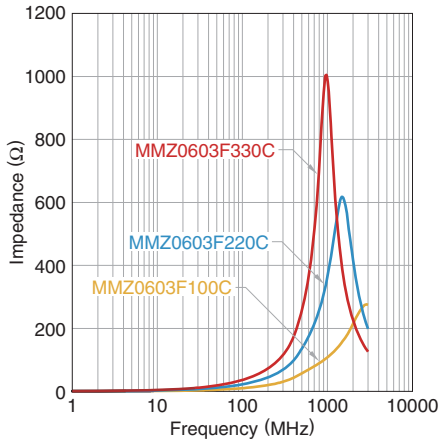

• All specifications are subject to change without notice.

MMZ series MMZ0603 Type

ELECTRICAL CHARACTERISTICS

Z, X, R VS. FREQUENCY CHARACTERISTICS

MMZ0603S100C

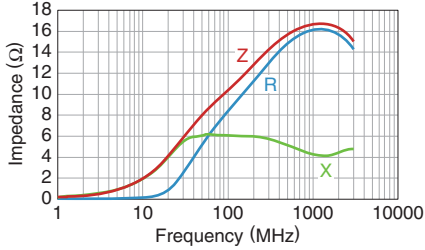

MMZ0603S800C

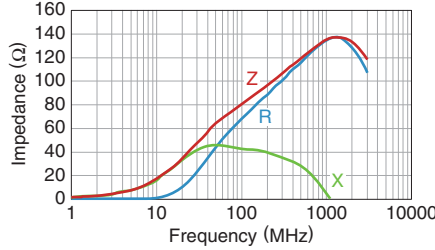

MMZ0603S121C

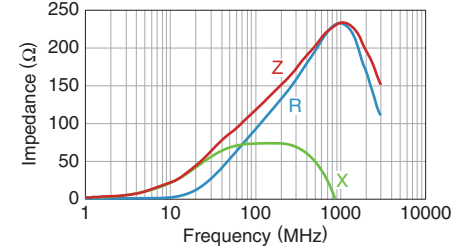

MMZ0603S241C

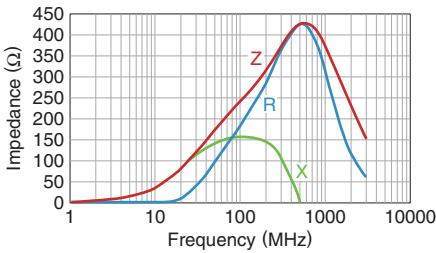

MMZ0603S471C

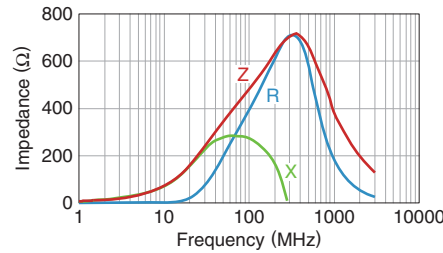

MMZ0603S601C

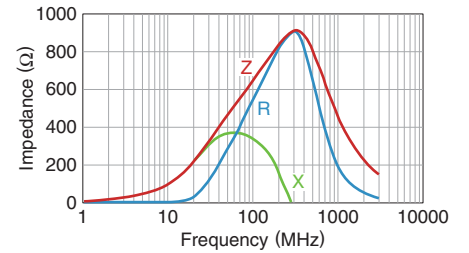

MMZ0603Y121C

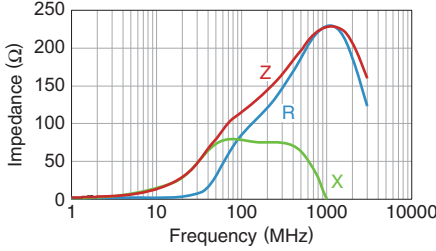

MMZ0603Y241C

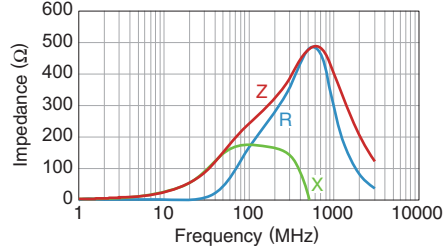

MMZ0603Y471C

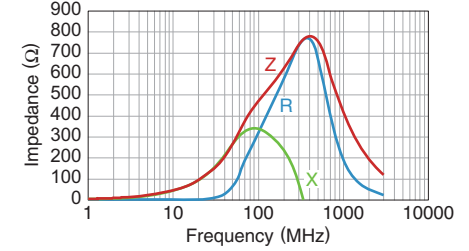

MMZ0603Y601C

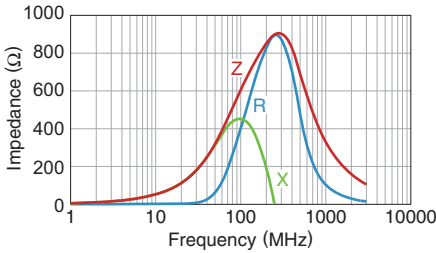

MMZ0603D330C

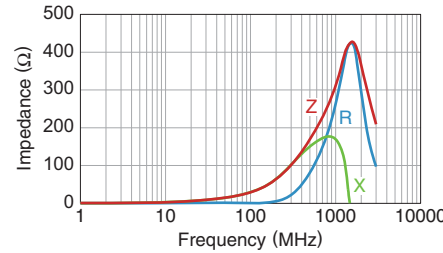

MMZ0603D560C

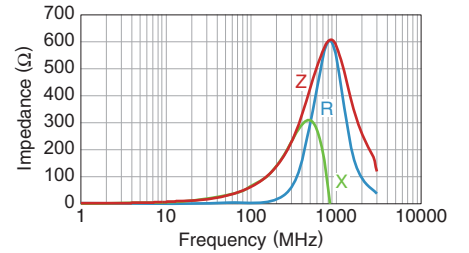

MMZ0603D800C

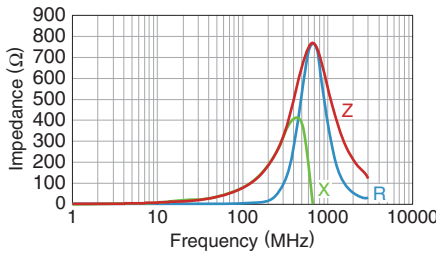

MMZ0603F100C

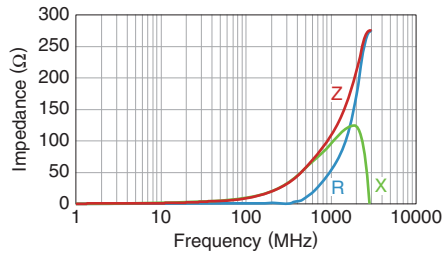

MMZ0603F220C

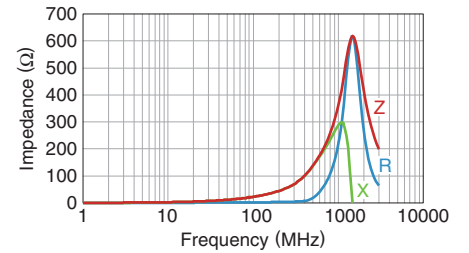

• All specifications are subject to change without notice.

MMZ series **MMZ0603 Type**

■ ELECTRICAL CHARACTERISTICS

□ Z, X, R VS. FREQUENCY CHARACTERISTICS

MMZ0603F330C

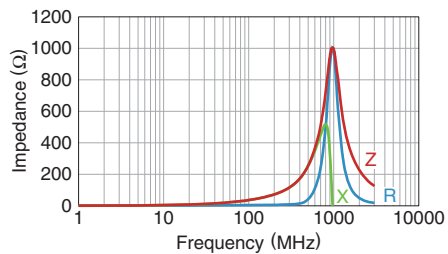

• All specifications are subject to change without notice.

MMZ series

MMZ1005 Type



SHAPE & DIMENSIONS

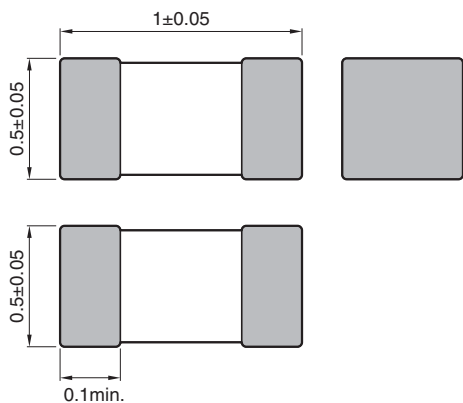

Dimensions in mm

RECOMMENDED LAND PATTERN

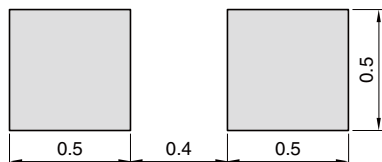

Dimensions in mm

• All specifications are subject to change without notice.

MMZ series MMZ1005 Type

ELECTRICAL CHARACTERISTICS

CHARACTERISTICS SPECIFICATION TABLE

Impedance [100MHz] (Ω)	Tolerance	DC resistance (Ω)max.	Rated current (mA)max.	Part No.
80	±25%	0.19	450	MMZ1005B800CT□□□
120	±25%	0.25	400	MMZ1005B121CT□□□
600	±25%	0.85	200	MMZ1005B601CT□□□
80	±25%	0.12	500	MMZ1005S800CT□□□
120	±25%	0.22	500	MMZ1005S121CT□□□
240	±25%	0.28	400	MMZ1005S241CT□□□
600	±25%	0.52	300	MMZ1005S601CT□□□
1000	±25%	0.75	200	MMZ1005S102CT□□□
40	±25%	0.10	550	MMZ1005Y400CT□□□
80	±25%	0.17	450	MMZ1005Y800CT□□□
120	±25%	0.18	400	MMZ1005Y121CT□□□
240	±25%	0.26	300	MMZ1005Y241CT□□□
300	±25%	0.38	250	MMZ1005Y301CT□□□
470	±25%	0.47	250	MMZ1005Y471CT□□□
600	±25%	0.54	250	MMZ1005Y601CT□□□
1000	±25%	0.70	200	MMZ1005Y102CT□□□
1500	±25%	1.00	100	MMZ1005Y152CT□□□
1800	±25%	0.85	150	MMZ1005Y182CT□□□
10	±5Ω	0.10	500	MMZ1005D100CT□□□
22	±25%	0.17	400	MMZ1005D220CT□□□
33	±25%	0.24	400	MMZ1005D330CT□□□
68	±25%	0.38	400	MMZ1005D680CT□□□
120	±25%	0.60	350	MMZ1005D121CT□□□
240	±25%	0.90	200	MMZ1005D241CT□□□
33	±25%	0.50	200	MMZ1005F330CT□□□
47	±25%	0.60	100	MMZ1005F470CT□□□
56	±25%	0.70	100	MMZ1005F560CT□□□

Measurement equipment

Measurement item	Product No.	Manufacturer
Impedance	E4991A+16192A	Agilent Technologies
DC resistance	Type-7556	Yokogawa

* Equivalent measurement equipment may be used.

MMZ series **MMZ1005 Type**

■ ELECTRICAL CHARACTERISTICS

□ Z VS. FREQUENCY CHARACTERISTICS (BY SERIES)

MMZ1005B SERIES

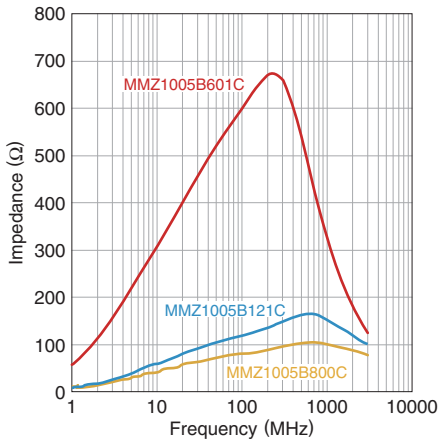

MMZ1005S SERIES

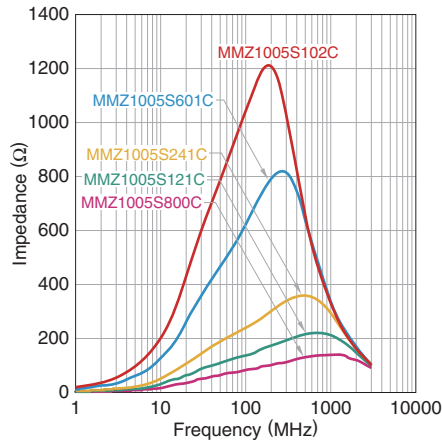

MMZ1005Y SERIES

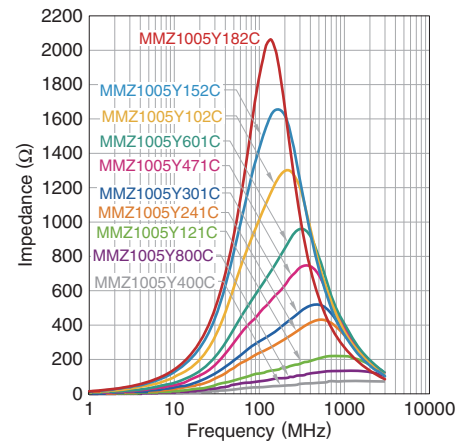

MMZ1005D SERIES

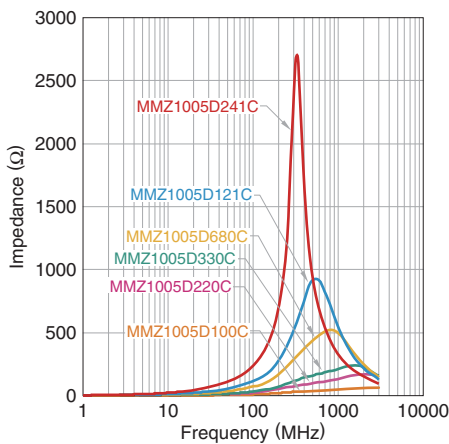

MMZ1005F SERIES

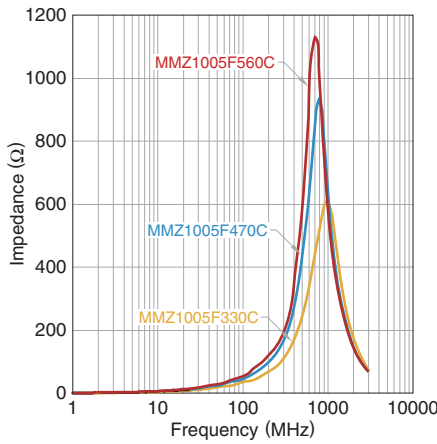

• All specifications are subject to change without notice.

MMZ series MMZ1005 Type

ELECTRICAL CHARACTERISTICS

Z, X, R VS. FREQUENCY CHARACTERISTICS

MMZ1005B800C

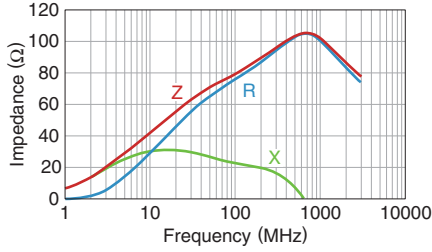

MMZ1005B121C

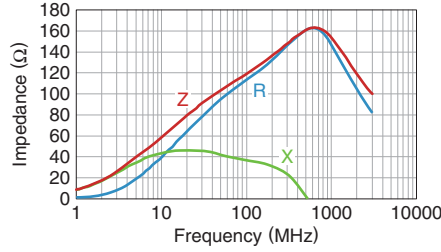

MMZ1005B601C

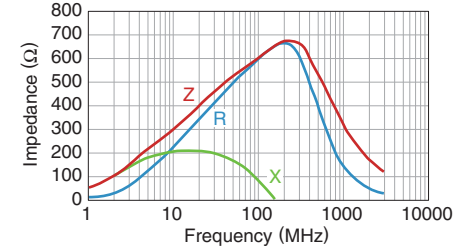

MMZ1005S800C

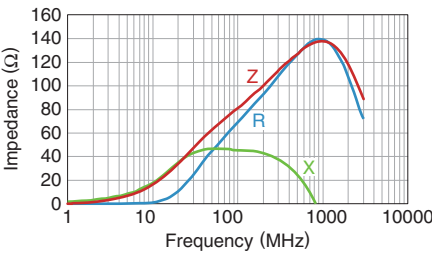

MMZ1005S121C

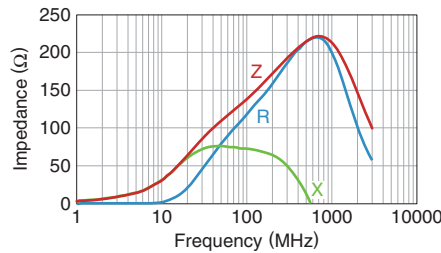

MMZ1005S241C

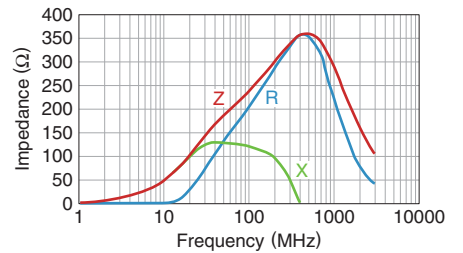

MMZ1005S601C

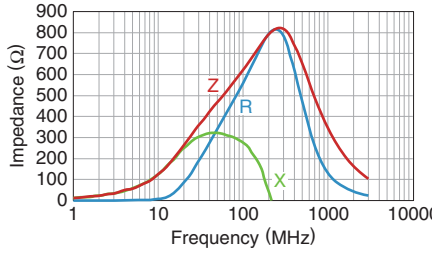

MMZ1005S102C

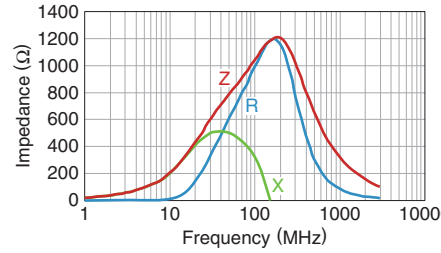

MMZ1005Y400C

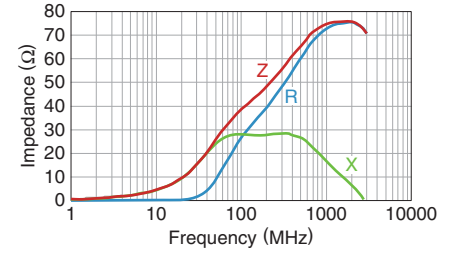

MMZ1005Y800C

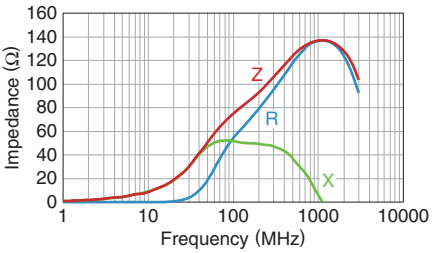

MMZ1005Y121C

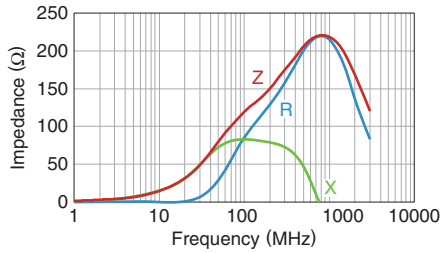

MMZ1005Y241C

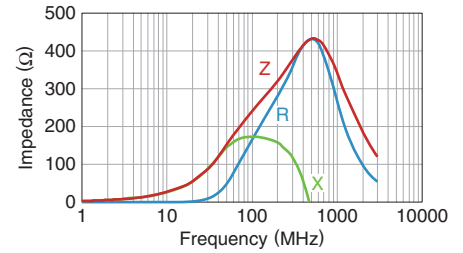

MMZ1005Y301C

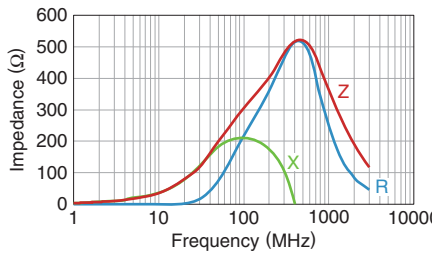

MMZ1005Y471C

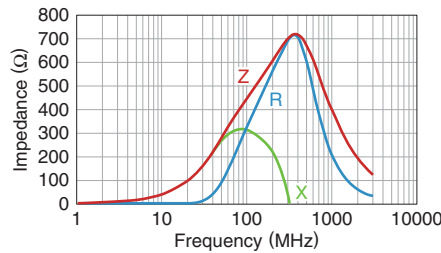

MMZ1005Y601C

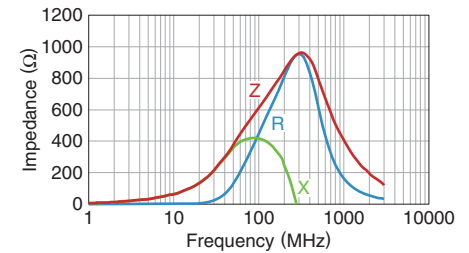

• All specifications are subject to change without notice.

MMZ series **MMZ1005 Type**

ELECTRICAL CHARACTERISTICS

Z, X, R VS. FREQUENCY CHARACTERISTICS

MMZ1005Y102C

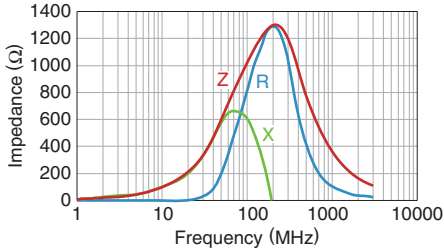

MMZ1005Y152C

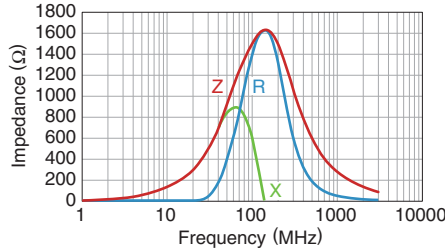

MMZ1005Y182C

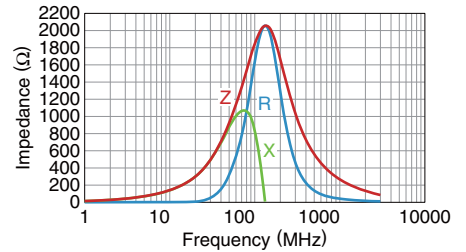

MMZ1005D100C

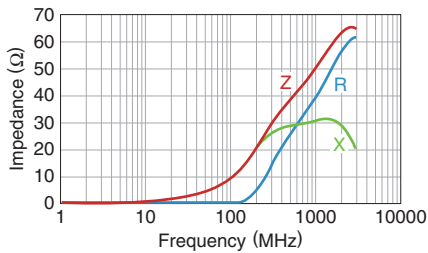

MMZ1005D220C

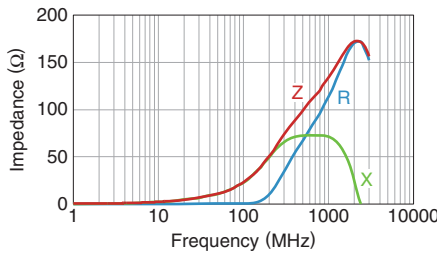

MMZ1005D330C

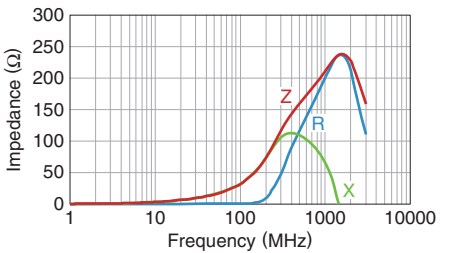

MMZ1005D680C

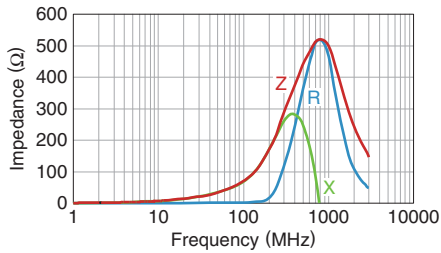

MMZ1005D121C

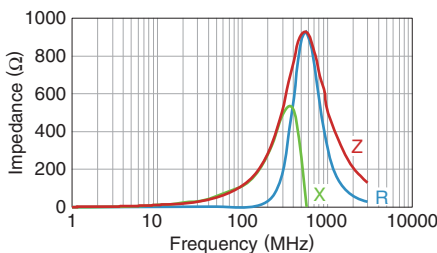

MMZ1005D241C

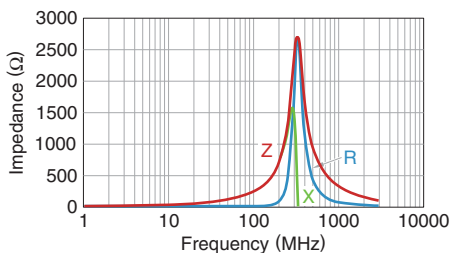

MMZ1005F330C

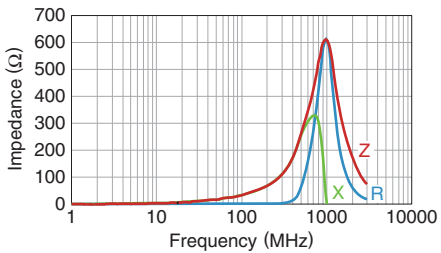

MMZ1005F470C

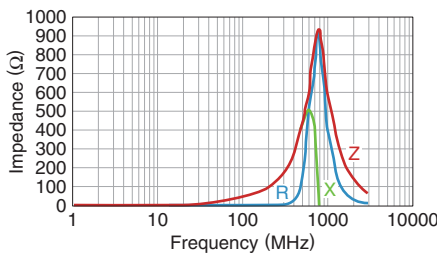

MMZ1005F560C

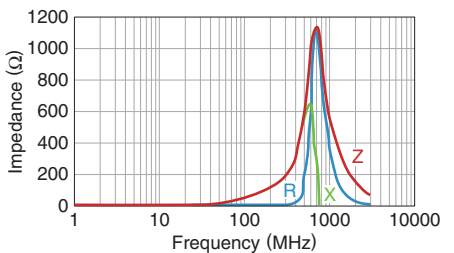

• All specifications are subject to change without notice.

MMZ series

MMZ1608 Type



SHAPE & DIMENSIONS

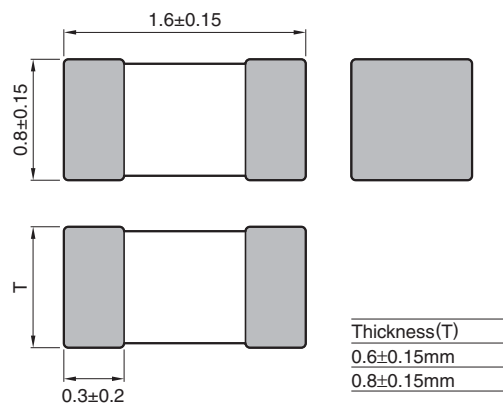

Dimensions in mm

RECOMMENDED LAND PATTERN

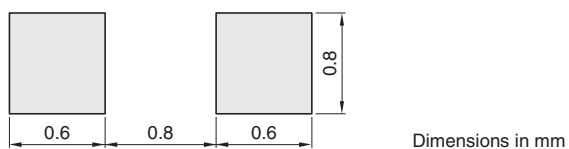

Dimensions in mm

MMZ series **MMZ1608 Type**

■ ELECTRICAL CHARACTERISTICS

□ CHARACTERISTICS SPECIFICATION TABLE

Impedance [100MHz] (Ω)	Tolerance	DC resistance (Ω)max.	Rated current (mA)max.	Thickness T (mm)	Part No.
120	±25%	0.15	600	0.6	MMZ1608B121CT□□□
220	±25%	0.25	500	0.6	MMZ1608B221CT□□□
300	±25%	0.25	500	0.6	MMZ1608B301CT□□□
470	±25%	0.30	500	0.6	MMZ1608B471CT□□□
600	±25%	0.40	500	0.6	MMZ1608B601CT□□□
1000	±25%	0.60	300	0.8	MMZ1608B102CT□□□
15	±25%	0.05	1500	0.8	MMZ1608R150AT□□□
30	±25%	0.05	1500	0.8	MMZ1608R300AT□□□
60	±25%	0.10	800	0.8	MMZ1608R600AT□□□
120	±25%	0.18	500	0.8	MMZ1608R121AT□□□
300	±25%	0.25	500	0.8	MMZ1608R301AT□□□
470	±25%	0.30	500	0.8	MMZ1608R471AT□□□
600	±25%	0.40	500	0.8	MMZ1608R601AT□□□
1000	±25%	0.50	400	0.8	MMZ1608R102AT□□□
40	±25%	0.10	600	0.8	MMZ1608S400AT□□□
80	±25%	0.15	500	0.8	MMZ1608S800AT□□□
120	±25%	0.15	500	0.8	MMZ1608S121AT□□□
180	±25%	0.20	500	0.8	MMZ1608S181AT□□□
220	±25%	0.20	500	0.8	MMZ1608S221AT□□□
300	±25%	0.30	500	0.8	MMZ1608S301AT□□□
470	±25%	0.30	500	0.8	MMZ1608S471AT□□□
600	±25%	0.35	500	0.8	MMZ1608S601AT□□□
1000	±25%	0.50	400	0.8	MMZ1608S102AT□□□
2000	±25%	0.90	200	0.8	MMZ1608S202AT□□□
15	±25%	0.05	1500	0.8	MMZ1608Y150BT□□□
30	±25%	0.05	1500	0.8	MMZ1608Y300BT□□□
60	±25%	0.15	500	0.8	MMZ1608Y600BT□□□
120	±25%	0.20	500	0.8	MMZ1608Y121BT□□□
220	±25%	0.30	500	0.8	MMZ1608Y221BT□□□
300	±25%	0.30	500	0.8	MMZ1608Y301BT□□□
470	±25%	0.35	500	0.8	MMZ1608Y471BT□□□
600	±25%	0.40	500	0.8	MMZ1608Y601BT□□□
750	±25%	0.45	500	0.8	MMZ1608Y751BT□□□
1000	±25%	0.50	400	0.8	MMZ1608Y102BT□□□
1500	±25%	0.60	300	0.8	MMZ1608Y152BT□□□
1800	±25%	0.80	200	0.8	MMZ1608A182BT□□□
2200	±25%	0.80	200	0.8	MMZ1608A222BT□□□
2500	±25%	0.80	200	0.8	MMZ1608A252BT□□□
120	±25%	0.30	500	0.8	MMZ1608Q121BT□□□
220	±25%	0.40	500	0.8	MMZ1608Q221BT□□□
330	±25%	0.50	400	0.8	MMZ1608Q331BT□□□
470	±25%	0.70	300	0.8	MMZ1608Q471BT□□□
600	±25%	0.80	200	0.8	MMZ1608Q601BT□□□
1000	±25%	1.00	200	0.8	MMZ1608Q102BT□□□

○ Measurement equipment

Measurement item	Product No.	Manufacturer
Impedance	E4991A+16192A	Agilent Technologies
DC resistance	Type-7556	Yokogawa

* Equivalent measurement equipment may be used.

MMZ series MMZ1608 Type

ELECTRICAL CHARACTERISTICS

CHARACTERISTICS SPECIFICATION TABLE

Impedance [100MHz] (Ω)	Tolerance	DC resistance (Ω)max.	Rated current (mA)max.	Thickness T (mm)	Part No.
5	$\pm 2\Omega$	0.05	700	0.8	MMZ1608D050CT□□□
10	$\pm 5\Omega$	0.10	500	0.6	MMZ1608D100CT□□□
22	$\pm 25\%$	0.20	500	0.6	MMZ1608D220CT□□□
50	$\pm 25\%$	0.25	500	0.6	MMZ1608D500CT□□□
80	$\pm 25\%$	0.30	500	0.6	MMZ1608D800CT□□□
80	$\pm 25\%$	0.30	500	0.8	MMZ1608D800BT□□□
120	$\pm 25\%$	0.30	400	0.6	MMZ1608D121CT□□□
120	$\pm 25\%$	0.30	400	0.8	MMZ1608D121BT□□□
240	$\pm 25\%$	0.60	300	0.8	MMZ1608D241CT□□□
300	$\pm 25\%$	0.70	300	0.8	MMZ1608D301BT□□□
3typ.		0.05	700	0.8	MMZ1608F030BT□□□
47	$\pm 25\%$	0.40	500	0.8	MMZ1608F470BT□□□
75	$\pm 25\%$	0.55	300	0.8	MMZ1608F750BT□□□
120	$\pm 25\%$	0.75	200	0.8	MMZ1608F121BT□□□

Measurement equipment

Measurement item	Product No.	Manufacturer
Impedance	E4991A+16192A	Agilent Technologies
DC resistance	Type-7556	Yokogawa

* Equivalent measurement equipment may be used.

MMZ series MMZ1608 Type

ELECTRICAL CHARACTERISTICS

Z VS. FREQUENCY CHARACTERISTICS (BY SERIES)

MMZ1608B SERIES

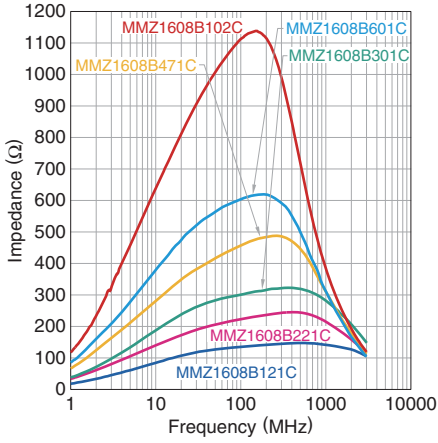

MMZ1608R SERIES

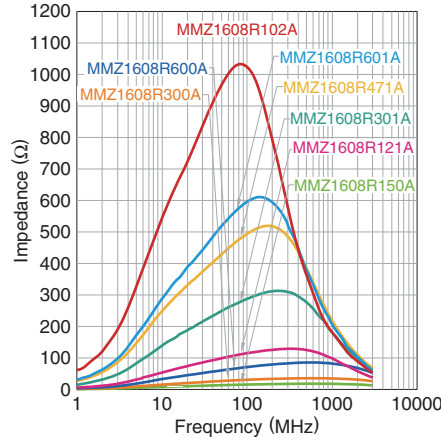

MMZ1608S SERIES

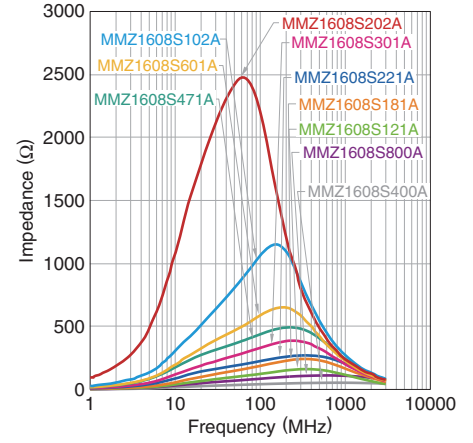

MMZ1608Y SERIES

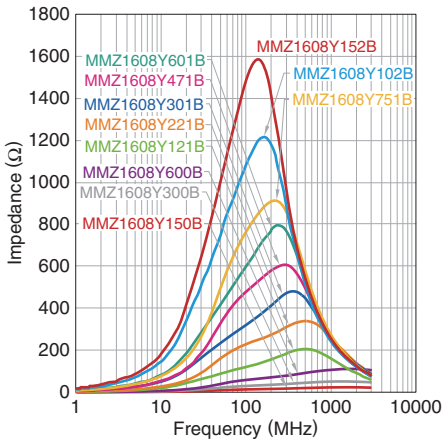

MMZ1608A SERIES

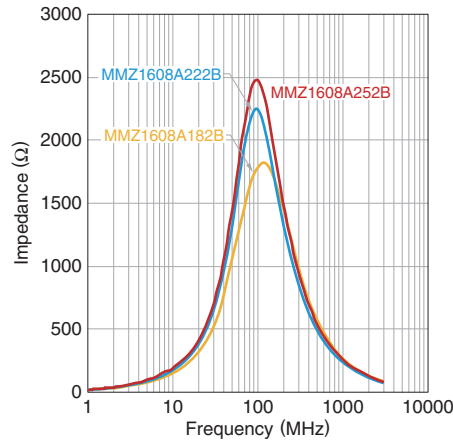

MMZ1608Q SERIES

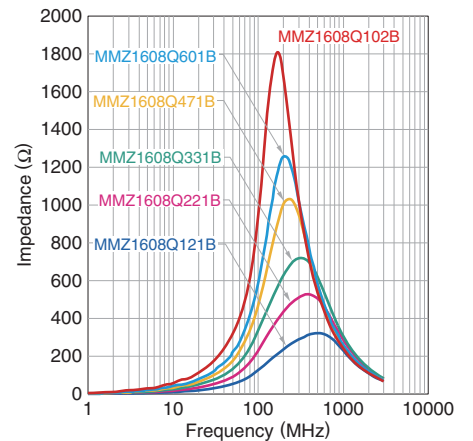

MMZ1608D SERIES

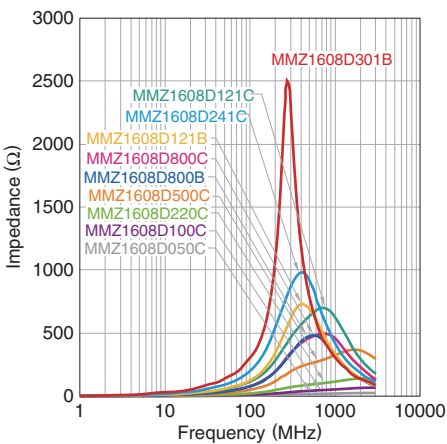

MMZ1608F SERIES

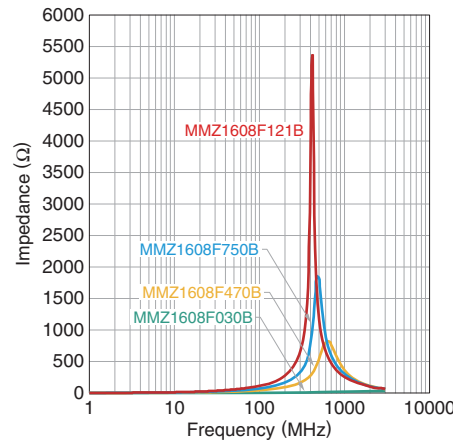

• All specifications are subject to change without notice.

MMZ series MMZ1608 Type

ELECTRICAL CHARACTERISTICS

Z, X, R VS. FREQUENCY CHARACTERISTICS

MMZ1608B121C

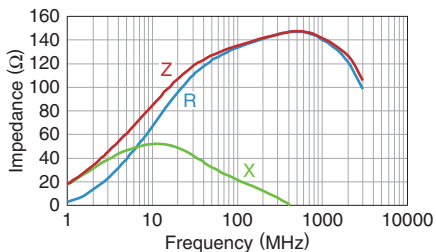

MMZ1608B221C

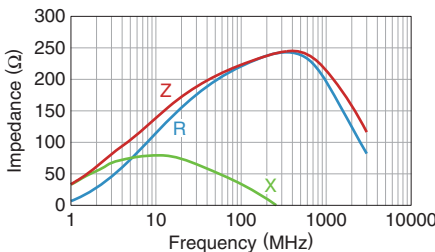

MMZ1608B301C

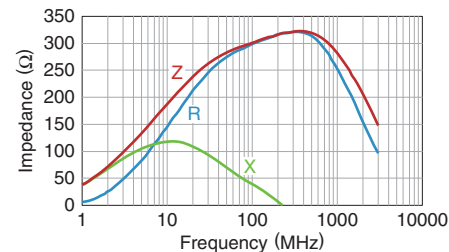

MMZ1608B471C

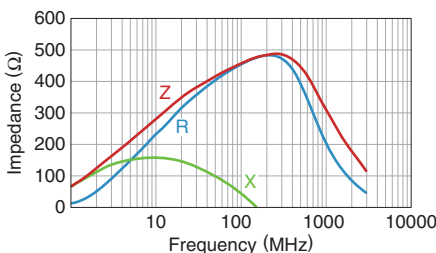

MMZ1608B601C

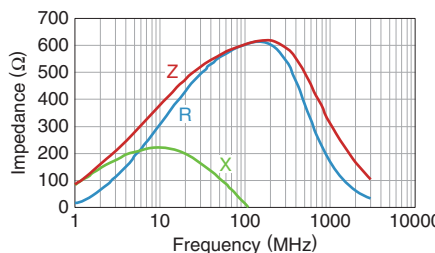

MMZ1608B102C

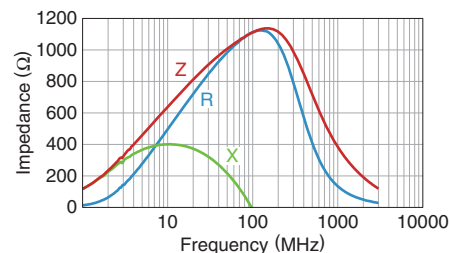

MMZ1608R150A

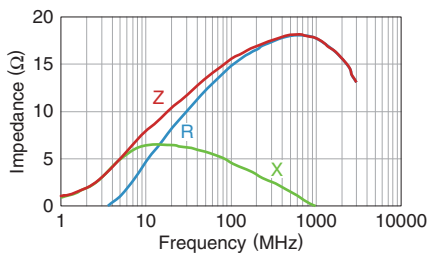

MMZ1608R300A

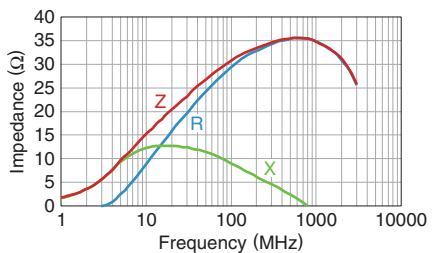

MMZ1608R600A

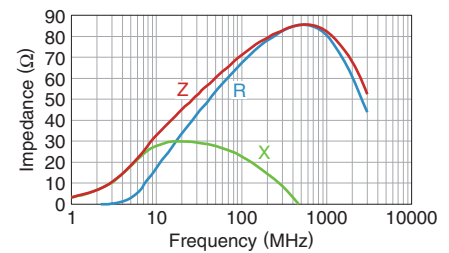

MMZ1608R121A

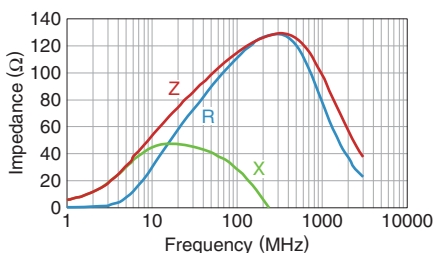

MMZ1608R301A

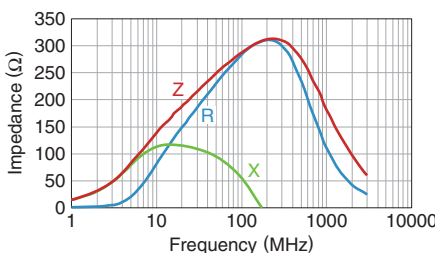

MMZ1608R471A

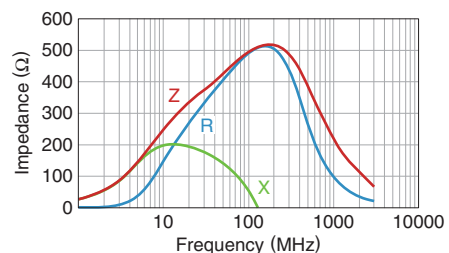

MMZ1608R601A

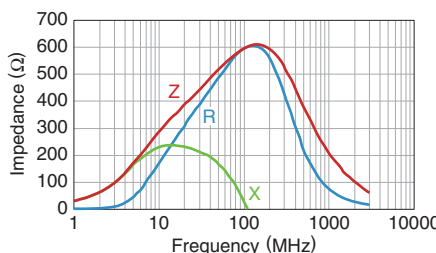

MMZ1608R102A

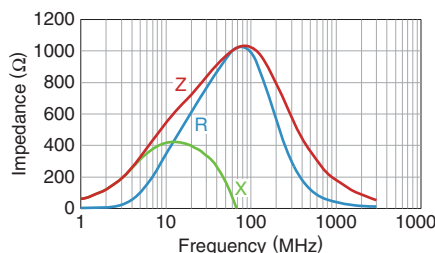

MMZ1608S400A

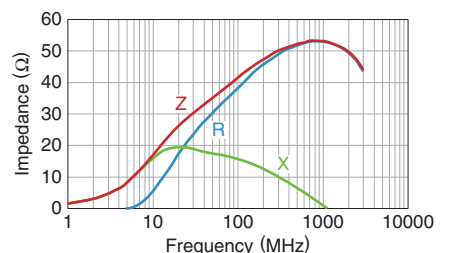

• All specifications are subject to change without notice.

MMZ series MMZ1608 Type

ELECTRICAL CHARACTERISTICS

Z, X, R VS. FREQUENCY CHARACTERISTICS

MMZ1608S800A

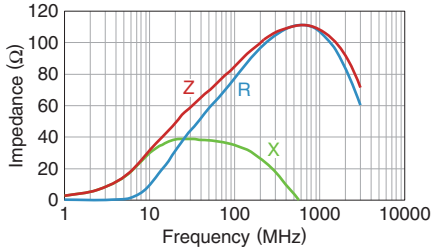

MMZ1608S121A

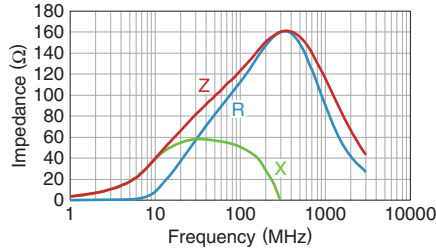

MMZ1608S181A

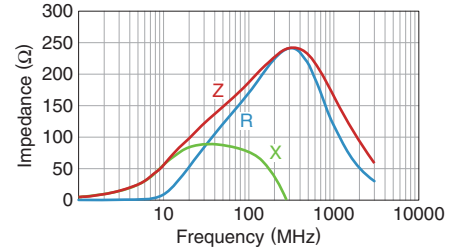

MMZ1608S221A

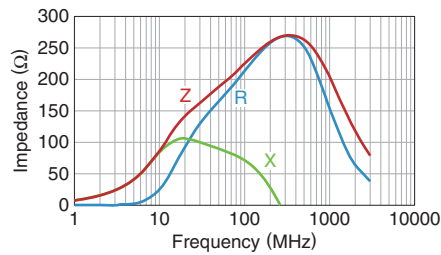

MMZ1608S301A

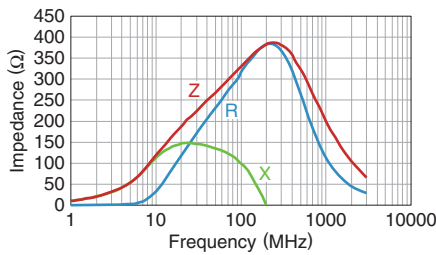

MMZ1608S471A

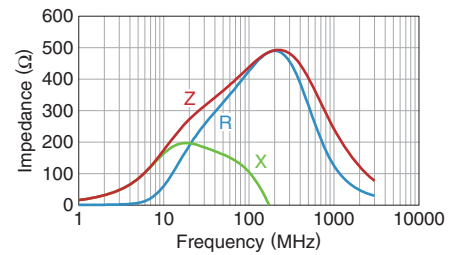

MMZ1608S601A

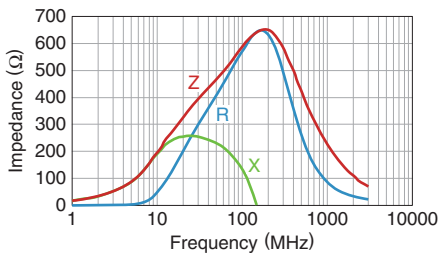

MMZ1608S102A

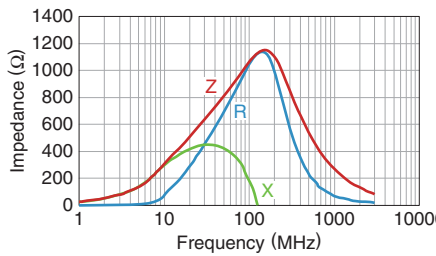

MMZ1608S202A

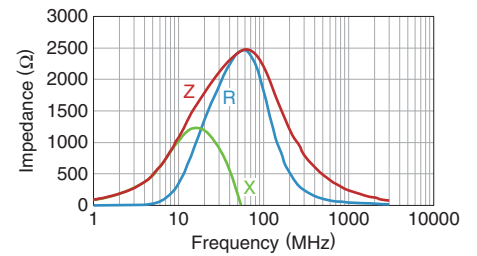

MMZ1608Y150B

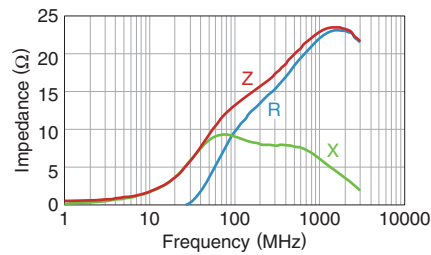

MMZ1608Y300B

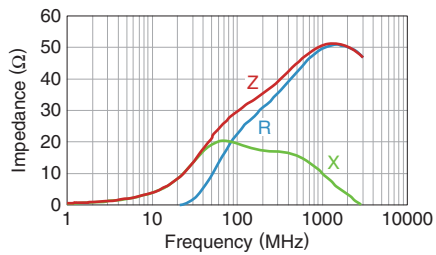

MMZ1608Y600B

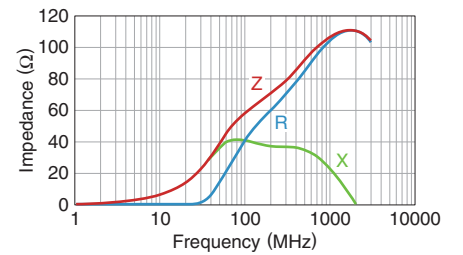

MMZ1608Y121B

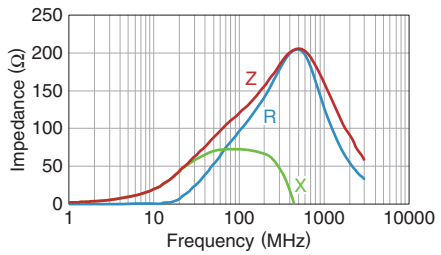

MMZ1608Y221B

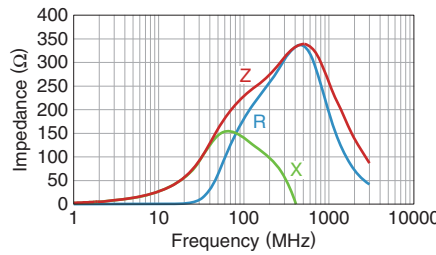

MMZ1608Y301B

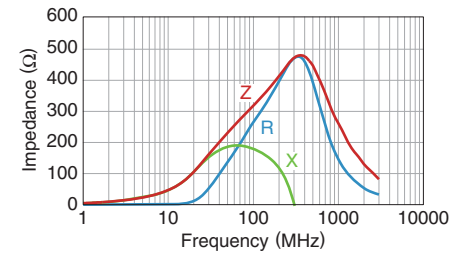

• All specifications are subject to change without notice.

MMZ series MMZ1608 Type

ELECTRICAL CHARACTERISTICS

Z, X, R VS. FREQUENCY CHARACTERISTICS

MMZ1608Y471B

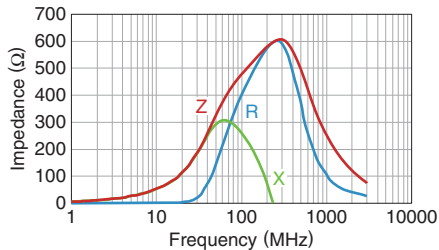

MMZ1608Y601B

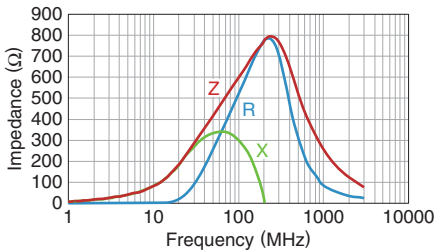

MMZ1608Y751B

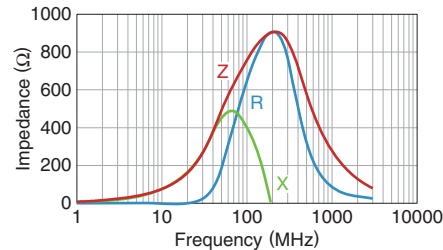

MMZ1608Y102B

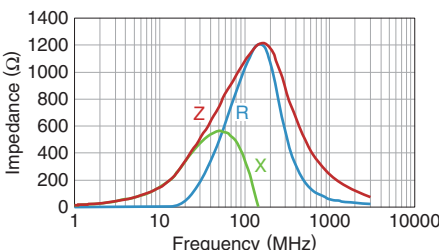

MMZ1608Y152B

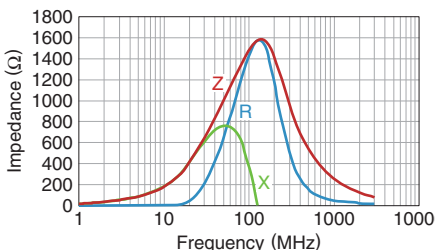

MMZ1608A182B

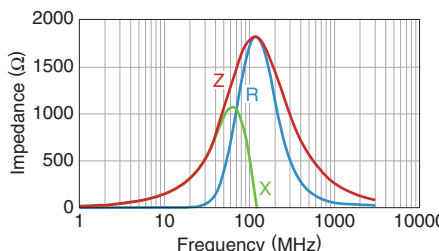

MMZ1608A222B

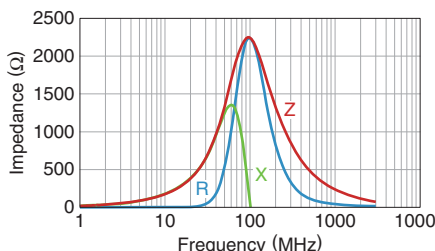

MMZ1608A252B

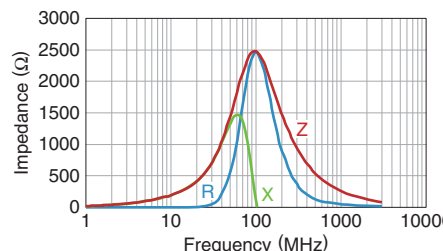

MMZ1608Q121B

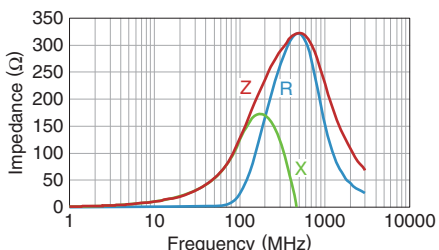

MMZ1608Q221B

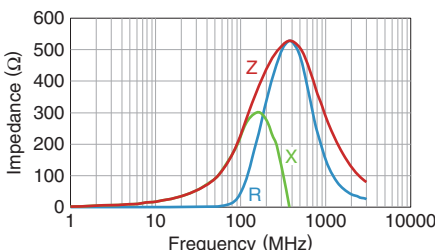

MMZ1608Q331B

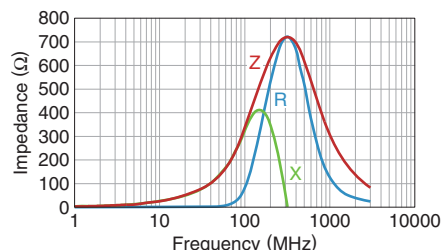

MMZ1608Q471B

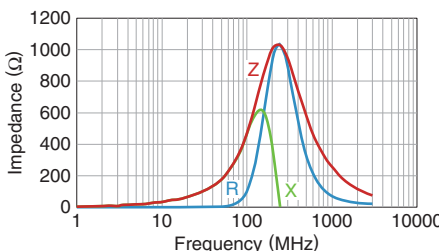

MMZ1608Q601B

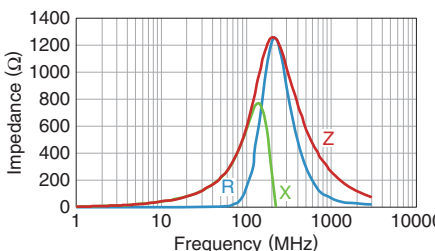

MMZ1608Q102B

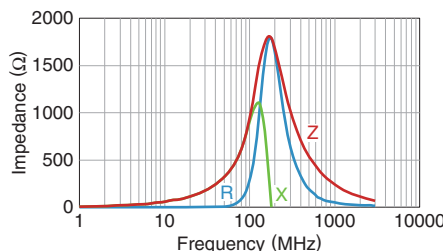

• All specifications are subject to change without notice.

MMZ series MMZ1608 Type

ELECTRICAL CHARACTERISTICS

Z, X, R VS. FREQUENCY CHARACTERISTICS

MMZ1608D050C

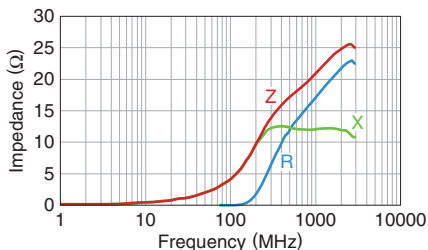

MMZ1608D100C

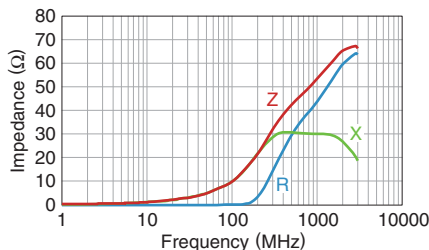

MMZ1608D220C

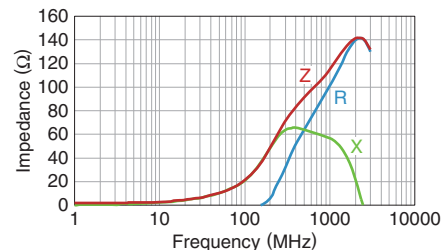

MMZ1608D500C

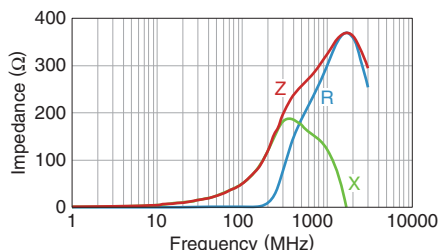

MMZ1608D800C

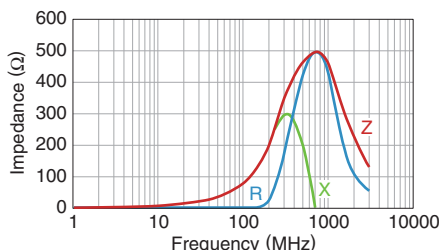

MMZ1608D800B

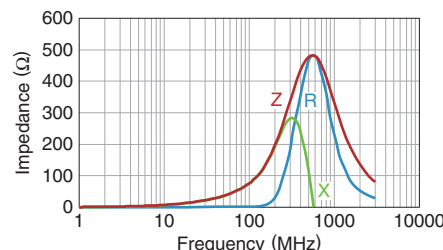

MMZ1608D121C

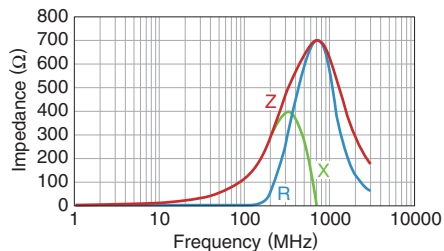

MMZ1608D121B

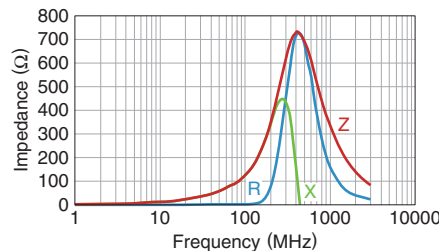

MMZ1608D241C

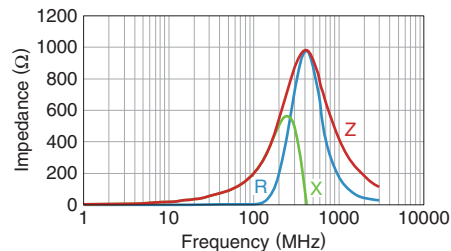

MMZ1608D301B

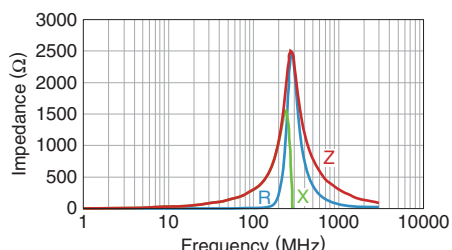

MMZ1608F030B

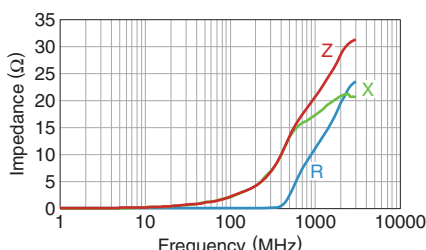

MMZ1608F470B

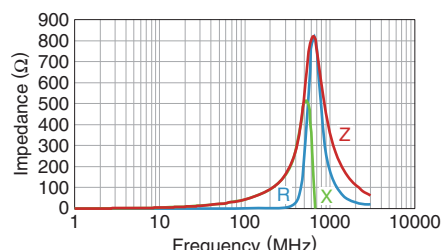

MMZ1608F750B

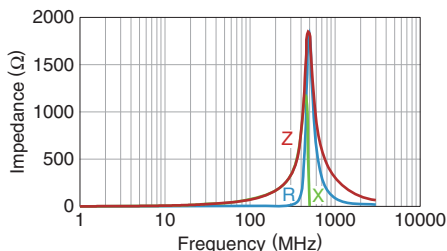

MMZ1608F121B

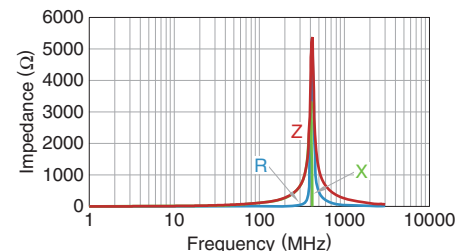

• All specifications are subject to change without notice.

MMZ series

MMZ2012 Type



SHAPE & DIMENSIONS

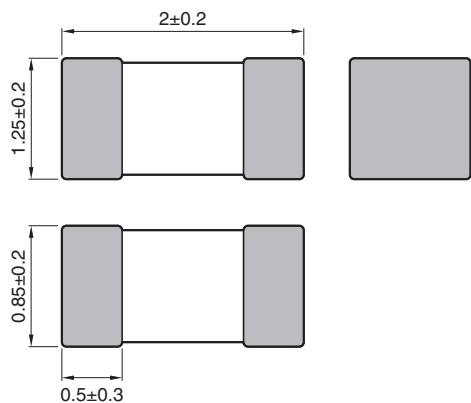

Dimensions in mm

RECOMMENDED LAND PATTERN

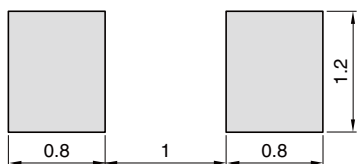

Dimensions in mm

MMZ series MMZ2012 Type

ELECTRICAL CHARACTERISTICS

CHARACTERISTICS SPECIFICATION TABLE

Impedance [100MHz] (Ω)	Tolerance	DC resistance (Ω)max.	Rated current (mA)max.	Part No.
15	±25%	0.05	1500	MMZ2012R150AT□□□
30	±25%	0.05	1500	MMZ2012R300AT□□□
60	±25%	0.10	1000	MMZ2012R600AT□□□
120	±25%	0.12	800	MMZ2012R121AT□□□
300	±25%	0.15	600	MMZ2012R301AT□□□
600	±25%	0.20	500	MMZ2012R601AT□□□
1000	±25%	0.30	500	MMZ2012R102AT□□□
40	±25%	0.10	1000	MMZ2012S400AT□□□
80	±25%	0.10	800	MMZ2012S800AT□□□
120	±25%	0.15	800	MMZ2012S121AT□□□
180	±25%	0.15	600	MMZ2012S181AT□□□
300	±25%	0.20	600	MMZ2012S301AT□□□
600	±25%	0.30	500	MMZ2012S601AT□□□
1000	±25%	0.35	500	MMZ2012S102AT□□□
15	±25%	0.05	1500	MMZ2012Y150BT□□□
30	±25%	0.05	1500	MMZ2012Y300BT□□□
60	±25%	0.10	1000	MMZ2012Y600BT□□□
120	±25%	0.12	800	MMZ2012Y121BT□□□
300	±25%	0.15	600	MMZ2012Y301BT□□□
600	±25%	0.20	500	MMZ2012Y601BT□□□
1000	±25%	0.30	500	MMZ2012Y102BT□□□
1500	±25%	0.40	500	MMZ2012Y152BT□□□
2000	±25%	0.50	400	MMZ2012Y202BT□□□
80	±25%	0.30	500	MMZ2012D800BT□□□
120	±25%	0.30	500	MMZ2012D121BT□□□
300	±25%	0.50	400	MMZ2012D301BT□□□

Measurement equipment

Measurement item	Product No.	Manufacturer
Impedance	E4991A+16192A	Agilent Technologies
DC resistance	Type-7556	Yokogawa

* Equivalent measurement equipment may be used.

MMZ series MMZ2012 Type

ELECTRICAL CHARACTERISTICS

Z VS. FREQUENCY CHARACTERISTICS (BY SERIES)

MMZ2012R SERIES

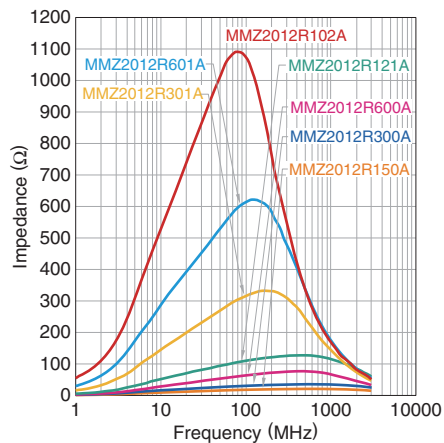

MMZ2012S SERIES

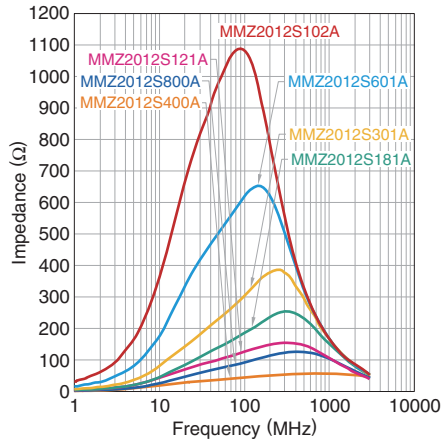

MMZ2012Y SERIES

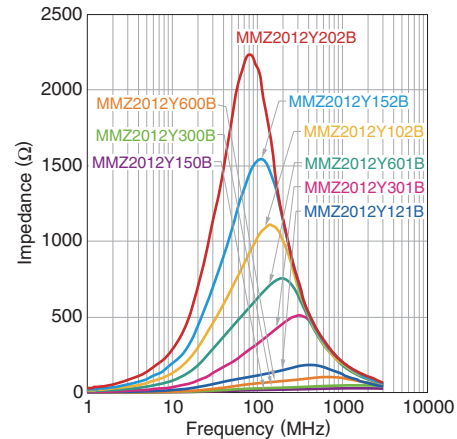

MMZ2012D SERIES

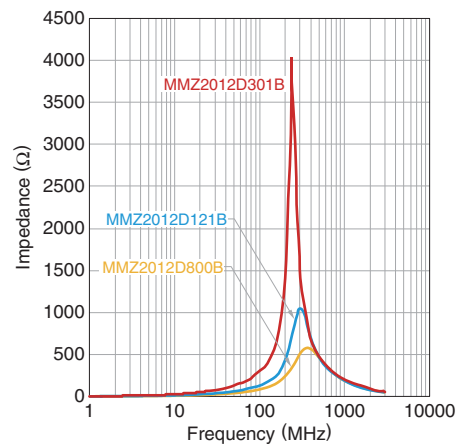

• All specifications are subject to change without notice.

MMZ series MMZ2012 Type

ELECTRICAL CHARACTERISTICS

Z, X, R VS. FREQUENCY CHARACTERISTICS

MMZ2012R150A

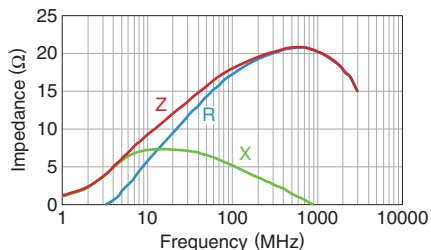

MMZ2012R300A

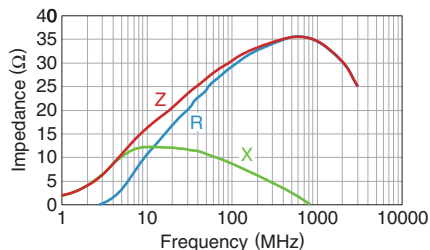

MMZ2012R600A

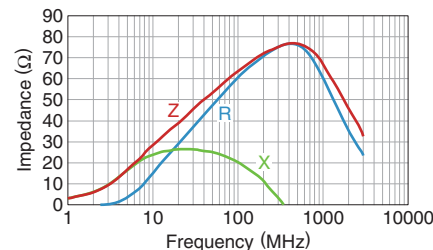

MMZ2012R121A

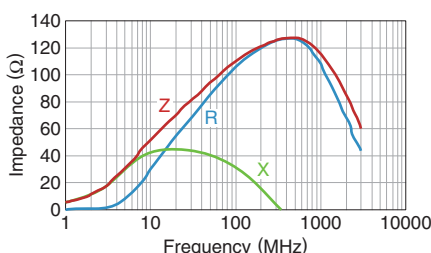

MMZ2012R301A

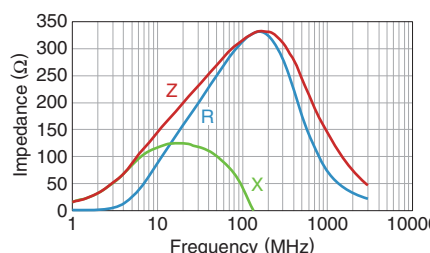

MMZ2012R601A

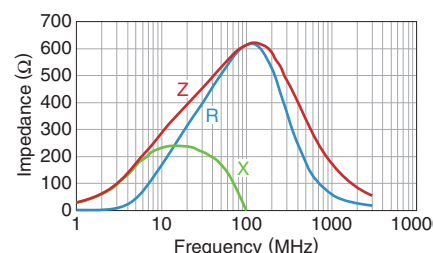

MMZ2012R102A

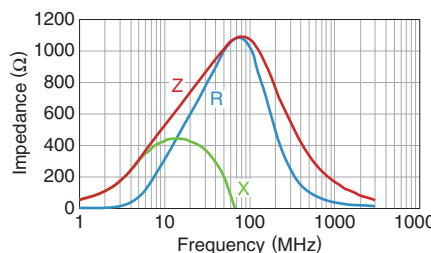

MMZ2012S400A

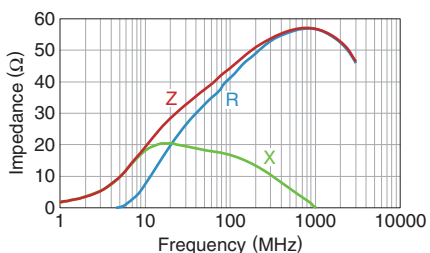

MMZ2012S800A

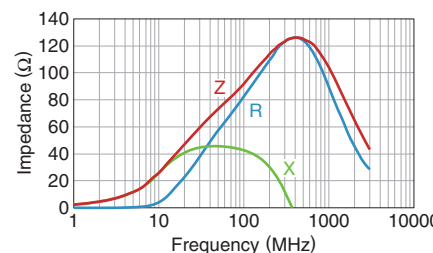

MMZ2012S121A

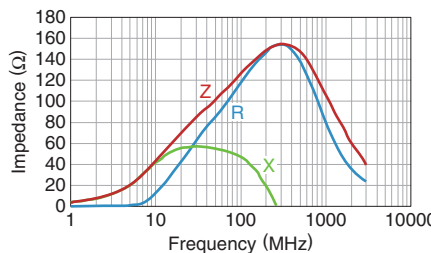

MMZ2012S181A

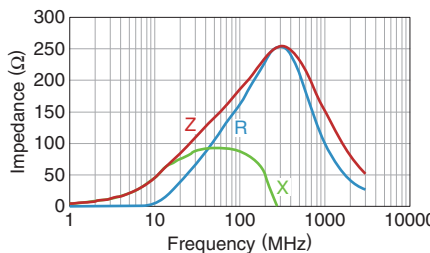

MMZ2012S301A

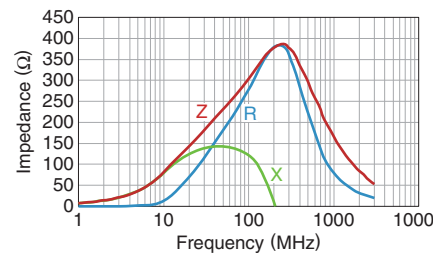

MMZ2012S601A

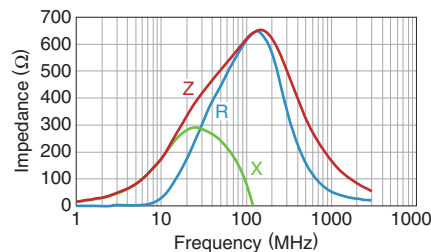

MMZ2012S102A

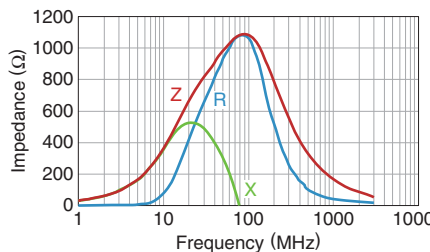

MMZ2012Y150B

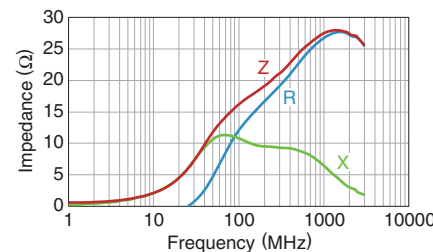

• All specifications are subject to change without notice.

MMZ series MMZ2012 Type

ELECTRICAL CHARACTERISTICS

Z, X, R VS. FREQUENCY CHARACTERISTICS

MMZ2012Y300B

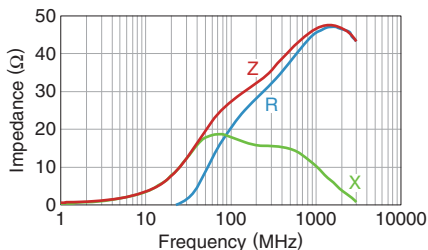

MMZ2012Y600B

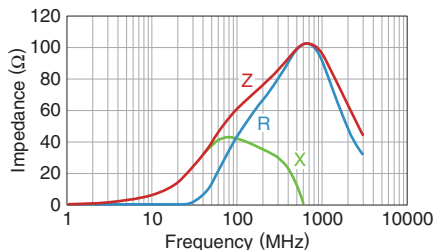

MMZ2012Y121B

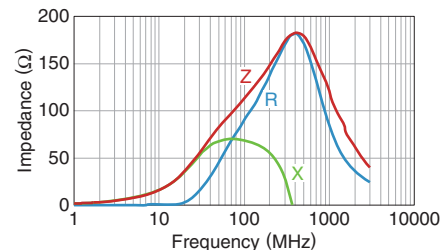

MMZ2012Y301B

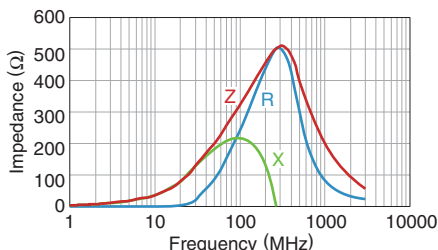

MMZ2012Y601B

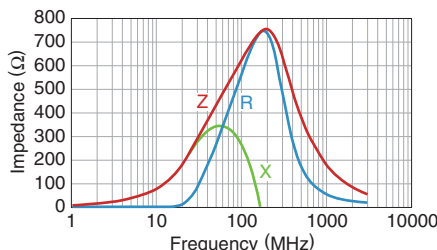

MMZ2012Y102B

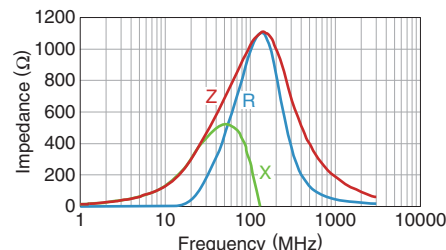

MMZ2012Y152B

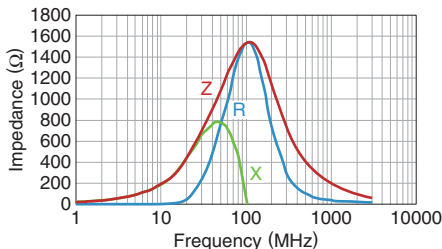

MMZ2012Y202B

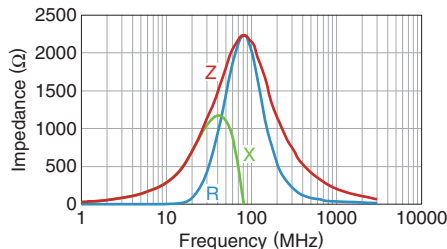

MMZ2012D800B

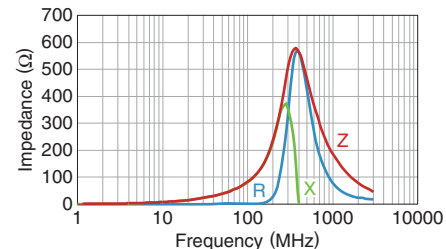

MMZ2012D121B

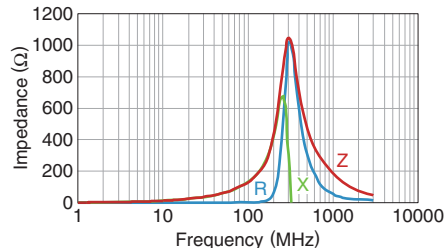

MMZ2012D301B

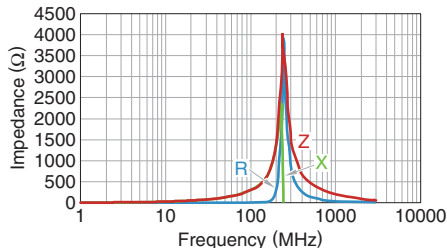

• All specifications are subject to change without notice.

MMZ series

Packaging style

REEL DIMENSIONS

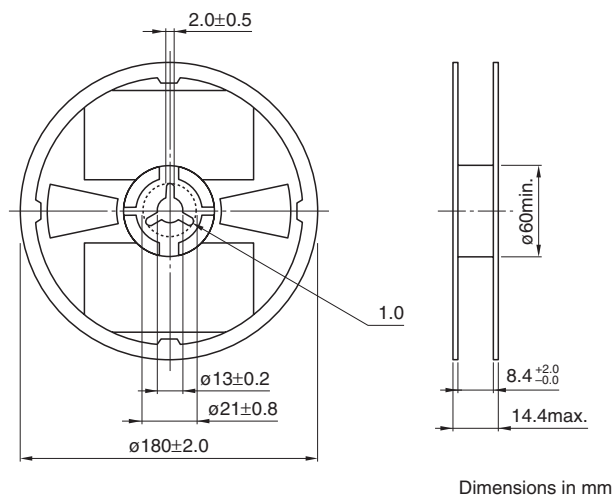

Dimensions in mm

TAPE DIMENSIONS

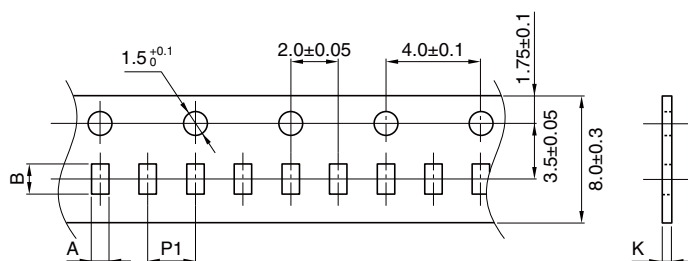

Dimensions in mm

Type	A	B	P1	K
MMZ0402	0.26±0.04	0.46±0.04	2.0±0.05	0.4max.
MMZ0603	0.38±0.05	0.68±0.05	2.0±0.05	0.5max.
MMZ1005	0.65±0.1	1.15±0.1	2.0±0.05	0.8max.
MMZ1608	1.1±0.2	1.9±0.2	4.0±0.1	1.1max.
MMZ2012	1.5±0.2	2.3±0.2	4.0±0.1	1.1max.

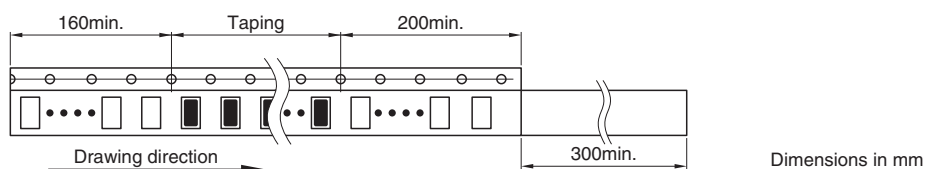

Dimensions in mm

• All specifications are subject to change without notice.