



Chip beads

For power line

MPZ series

MPZ1608_{Type}

MPZ1608

1608[0603 inch]*

* Dimensions code Dimensions code JIS[EIA]

Reminders for using these products

Before using these products, be sure to request the delivery specifications.

Safety reminders

Please pay sufficient attention to the warnings for safe designing when using this products.

Reminders

- The storage period is less than 12 months. Be sure to follow the storage conditions (temperature: 5 to 40°C, humidity: 10 to 75% RH or less).
If the storage period elapses, the soldering of the terminal electrodes may deteriorate.
- Do not use or store in locations where there are conditions such as gas corrosion (salt, acid, alkali, etc.).
- Before soldering, be sure to preheat components.
The preheating temperature should be set so that the temperature difference between the solder temperature and chip temperature does not exceed 150°C.
- Soldering corrections after mounting should be within the range of the conditions determined in the specifications.
If overheated, a short circuit, performance deterioration, or lifespan shortening may occur.
- When embedding a printed circuit board where a chip is mounted to a set, be sure that residual stress is not given to the chip due to the overall distortion of the printed circuit board and partial distortion such as at screw tightening portions.
- Self heating (temperature increase) occurs when the power is turned ON, so the tolerance should be sufficient for the set thermal design.
- Carefully lay out the coil for the circuit board design of the non-magnetic shield type.
A malfunction may occur due to magnetic interference.
- Use a wrist band to discharge static electricity in your body through the grounding wire.
- Do not expose the products to magnets or magnetic fields.
- Do not use for a purpose outside of the contents regulated in the delivery specifications.
- The products listed on this catalog are intended for use in general electronic equipment (AV equipment, telecommunications equipment, home appliances, amusement equipment, computer equipment, personal equipment, office equipment, measurement equipment, industrial robots) under a normal operation and use condition.
The products are not designed or warranted to meet the requirements of the applications listed below, whose performance and/or quality require a more stringent level of safety or reliability, or whose failure, malfunction or trouble could cause serious damage to society, person or property.
If you intend to use the products in the applications listed below or if you have special requirements exceeding the range or conditions set forth in the each catalog, please contact us.

- (1) Aerospace/aviation equipment
- (2) Transportation equipment (cars, electric trains, ships, etc.)
- (3) Medical equipment
- (4) Power-generation control equipment
- (5) Atomic energy-related equipment
- (6) Seabed equipment
- (7) Transportation control equipment

- (8) Public information-processing equipment
- (9) Military equipment
- (10) Electric heating apparatus, burning equipment
- (11) Disaster prevention/crime prevention equipment
- (12) Safety equipment
- (13) Other applications that are not considered general-purpose applications

When designing your equipment even for general-purpose applications, you are kindly requested to take into consideration securing protection circuit/device or providing backup circuits in your equipment.

Chip beads

For power line

Product compatible with RoHS directive
Halogen-free
Compatible with lead-free solders

Overview of MPZ1608 type

FEATURES

- Noise reduction solution for power line.
- Compared to the MMZ series, has low direct current resistance for compatibility with large currents, optimal for low power consumption.
- Various frequency characteristics with 5 materials of different features for countermeasures against everything from general signals to high-speed signals.
- Performs well even in signal lines where low direct current resistance is required.

APPLICATION

- Noise removal for mobile devices such as smartphones and tablet terminals, and various modules.
- Noise removal for PCs and recorders, household appliances such as STBs, smart grids, and industrial equipment.

PART NUMBER CONSTRUCTION

MPZ	1608	B	471	A	T	A00		
Series name	LxWxT dimensions (mm)	Material name	Impedance (Ω) at 100MHz		Characteristic type	Packaging style	Internal code	
MPZ1608	1608	1.6x0.8x0.6	S	260	26	A	T	A00
		1.6x0.8x0.8	Y	471	470	B	Taping	AH0
		B						
		R						
		D						

OPERATING TEMPERATURE RANGE, PACKAGE QUANTITY, PRODUCT WEIGHT

Type		Temperature ranges		Package quantity (pieces/reel)	Individual weight (mg)
		Operating temperature (°C)	Storage temperature* (°C)		
MPZ1608	t=0.6mm	-55 to +125	-55 to +125	4,000	3
	t=0.8mm	-55 to +125	-55 to +125	4,000	4

* The storage temperature range is for after the circuit board is mounted.

- RoHS Directive Compliant Product: See the following for more details.<https://product.tdk.com/info/en/environment/rohs/index.html>
- Halogen-free: indicates that Cl content is less than 900ppm, Br content is less than 900ppm, and that the total Cl and Br content is less than 1500ppm.

 Please be sure to request delivery specifications that provide further details on the features and specifications of the products for proper and safe use.
Please note that the contents may change without any prior notice due to reasons such as upgrading.

MPZ1608 type

RECOMMENDED REFLOW PROFILE



Preheating			Soldering		Peak	
Temp.		Time	Temp.	Time	Temp.	Time
T1	T2	t1	T3	t2	T4	t3
150°C	180°C	60 to 120s	230°C	30 to 60s	250 to 260°C	10s

MPZ1608 type

■ MATERIAL CHARACTERISTIC

B material: This type is perfectly suited for fast digital signals. By equalizing R components and X components that beads possess at a frequency of 5MHz, it is able to suppress overshooting, undershooting and ringing of fast digital signals.

R material: For wide frequency applications calling for broad impedance characteristics. For digital signal line applications calling requiring good waveform integrity. Impedance values selected for effectiveness at 10 to 200MHz.

S material: Standard type that features impedance characteristics similar to those of a typical ferrite core. For signal line applications in which the blocking region is near 100MHz. Impedance values selected for effectiveness at 40 to 300MHz.

Y material: High frequency range type intended for the 100MHz region and above. For signal line applications in which the signal frequency is far from the cutoff frequency. Impedance values selected for effectiveness at 80 to 400MHz.

D material: For applications calling for low insertion loss at low frequencies and sharply increasing impedance at high frequencies. Designed for high impedance at high frequencies (300MHz to 1GHz) for signal line applications.

■ TYPICAL MATERIAL IMPEDANCE CHARACTERISTICS

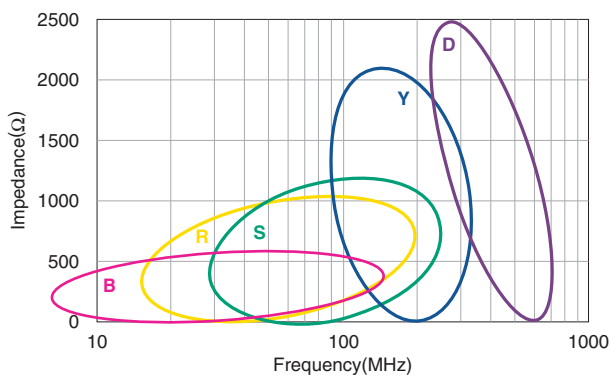

MPZ1608 type

SHAPE & DIMENSIONS

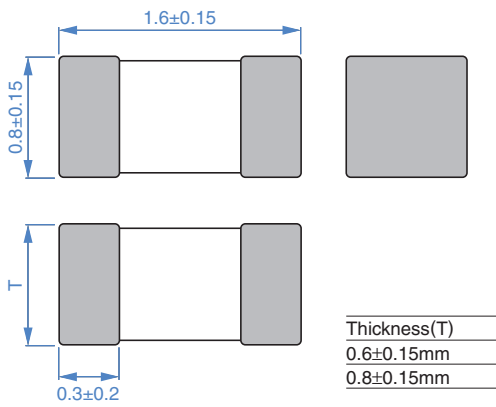

Dimensions in mm

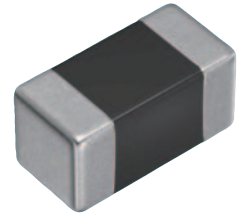

RECOMMENDED LAND PATTERN

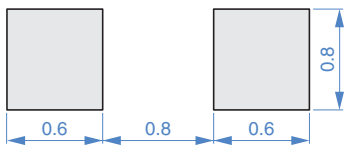

Dimensions in mm

MPZ1608 type

ELECTRICAL CHARACTERISTICS

CHARACTERISTICS SPECIFICATION TABLE

Impedance [100MHz] (Ω)		DC resistance (Ω)max.	Rated current* (A)max.	Thickness T (mm)	Part No.
Tolerance					
470	$\pm 25\%$	0.150	1.0	0.8	MPZ1608B471ATA00
26	$\pm 25\%$	0.007	6.0	0.6	MPZ1608S260ATAH0
30	$\pm 10\Omega$	0.010	5.0	0.6	MPZ1608S300ATAH0
60	$\pm 25\%$	0.020	3.5	0.6	MPZ1608S600ATAH0
100	$\pm 25\%$	0.030	3.0	0.6	MPZ1608S101ATAH0
120	$\pm 25\%$	0.045	2.0	0.6	MPZ1608S121ATAH0
180	$\pm 25\%$	0.050	2.0	0.6	MPZ1608S181ATAH0
220	$\pm 25\%$	0.050	2.2	0.8	MPZ1608S221ATA00
330	$\pm 25\%$	0.080	1.7	0.8	MPZ1608S331ATA00
470	$\pm 25\%$	0.150	1.0	0.8	MPZ1608S471ATA00
600	$\pm 25\%$	0.150	1.0	0.8	MPZ1608S601ATA00
1000	$\pm 25\%$	0.300	0.8	0.8	MPZ1608S102ATA00
390	$\pm 25\%$	0.120	1.2	0.8	MPZ1608R391ATA00
60	$\pm 25\%$	0.030	2.3	0.8	MPZ1608Y600BTA00
100	$\pm 25\%$	0.040	2.0	0.8	MPZ1608Y101BTA00
150	$\pm 25\%$	0.050	1.8	0.8	MPZ1608Y151BTA00
220	$\pm 25\%$	0.100	1.5	0.8	MPZ1608Y221BTA00
30	$\pm 10\Omega$	0.060	1.8	0.8	MPZ1608D300BTA00
60	$\pm 25\%$	0.100	1.2	0.8	MPZ1608D600BTA00
100	$\pm 25\%$	0.150	1.0	0.8	MPZ1608D101BTA00

* Please refer to the graph of rated current vs. temperature characteristics (derating) about the rating current at 85°C or more in temperature of the product.

Measurement equipment

Measurement item	Product No.	Manufacturer
Impedance	E4991A+16192A	Keysight Technologies
DC resistance	Type-7556	Yokogawa

* Equivalent measurement equipment may be used.

Rated current vs. temperature characteristics (derating)

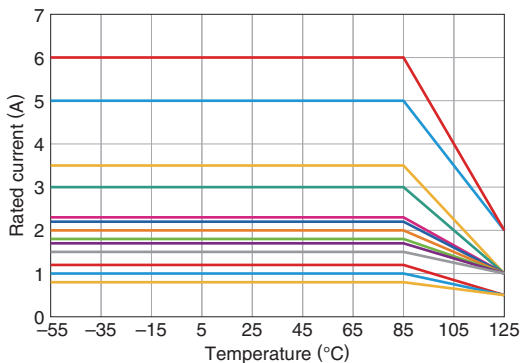

⚠ Please be sure to request delivery specifications that provide further details on the features and specifications of the products for proper and safe use.
Please note that the contents may change without any prior notice due to reasons such as upgrading.

MPZ1608 type

ELECTRICAL CHARACTERISTICS

Z VS. FREQUENCY CHARACTERISTICS (BY SERIES)

MPZ1608B series

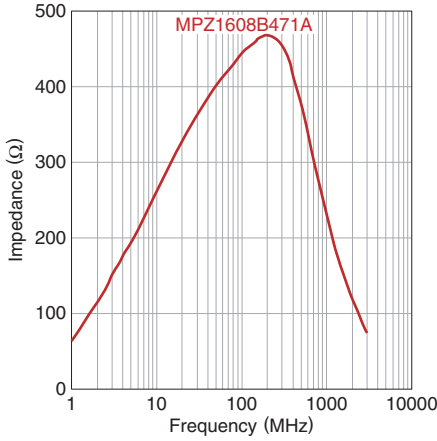

MPZ1608S series

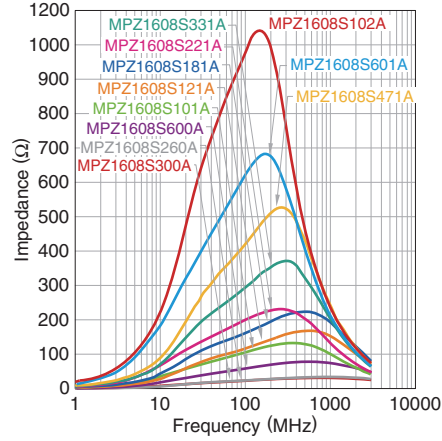

MPZ1608R series

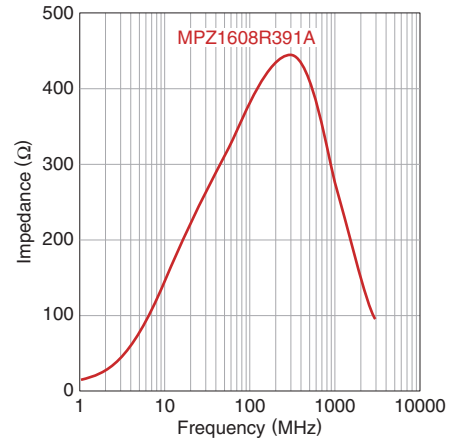

MPZ1608Y series

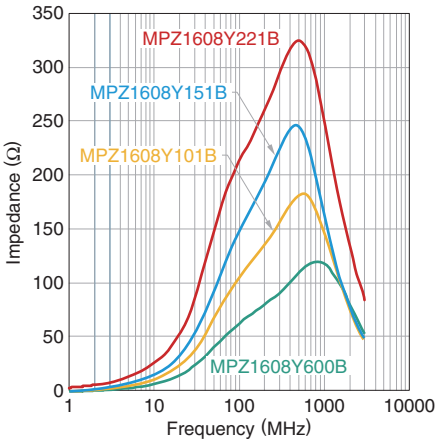

MPZ1608D series

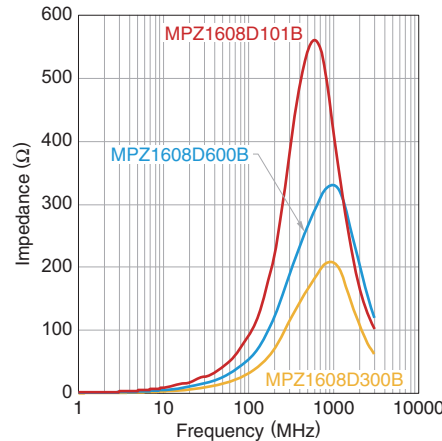

 Please be sure to request delivery specifications that provide further details on the features and specifications of the products for proper and safe use. Please note that the contents may change without any prior notice due to reasons such as upgrading.

MPZ1608 type

ELECTRICAL CHARACTERISTICS

Z, X, R VS. FREQUENCY CHARACTERISTICS

MPZ1608B471ATA00

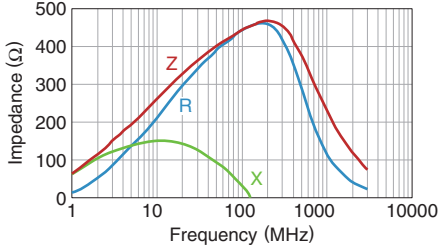

MPZ1608S260ATAH0

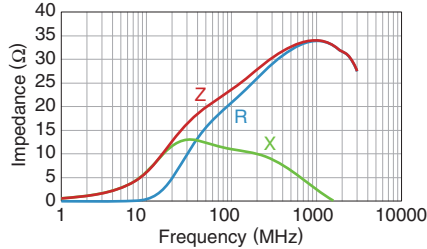

MPZ1608S300ATAH0

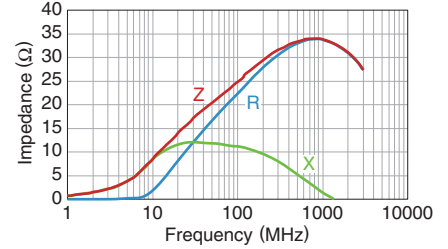

MPZ1608S600ATAH0

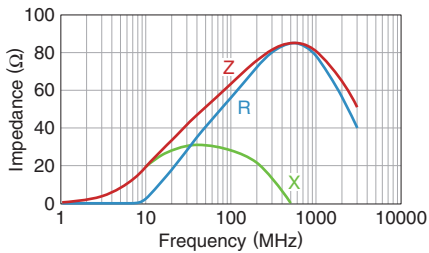

MPZ1608S101ATAH0

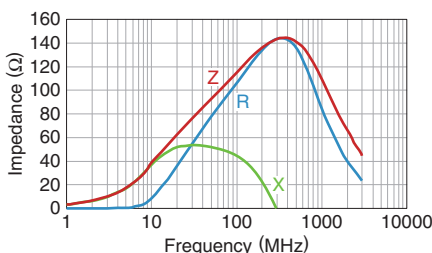

MPZ1608S121ATAH0

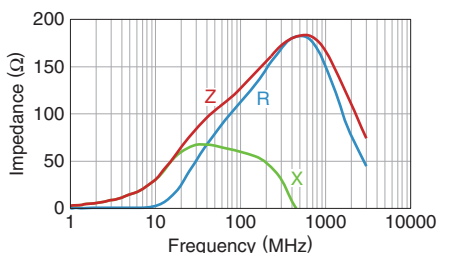

MPZ1608S181ATAH0

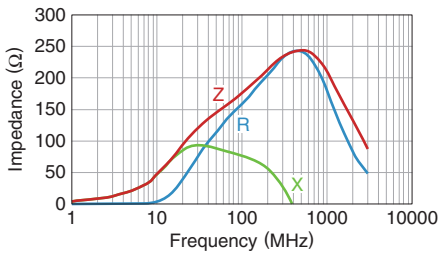

MPZ1608S221ATA00

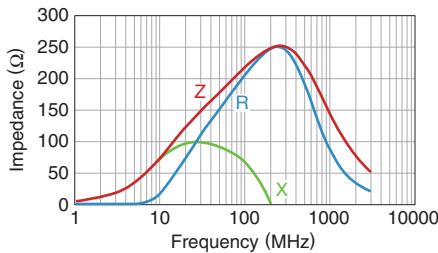

MPZ1608S331ATA00

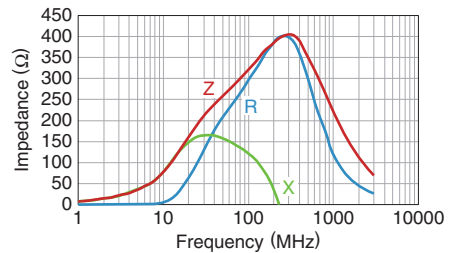

MPZ1608S471ATA00

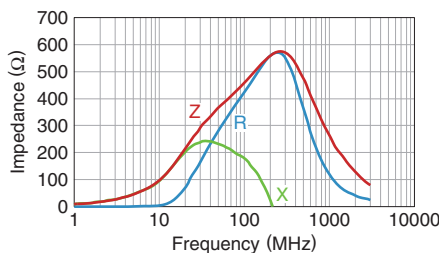

MPZ1608S601ATA00

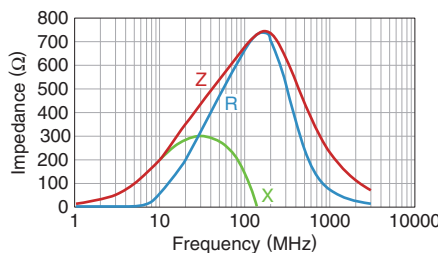

MPZ1608S102ATA00

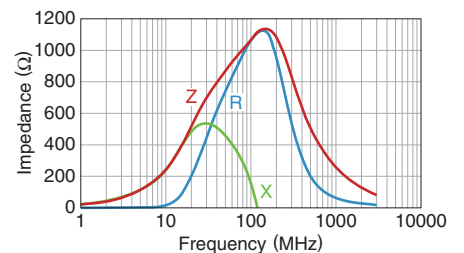

MPZ1608R391ATA00

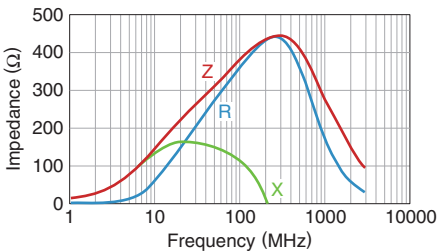

MPZ1608Y600BTA00

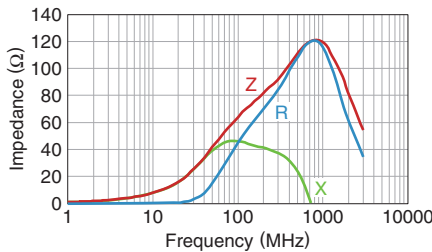

MPZ1608Y101BTA00

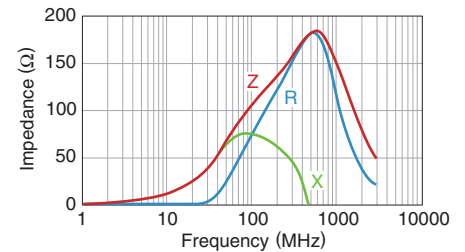

 Please be sure to request delivery specifications that provide further details on the features and specifications of the products for proper and safe use. Please note that the contents may change without any prior notice due to reasons such as upgrading.

MPZ1608 type

ELECTRICAL CHARACTERISTICS

Z, X, R VS. FREQUENCY CHARACTERISTICS

MPZ1608Y151BTA00

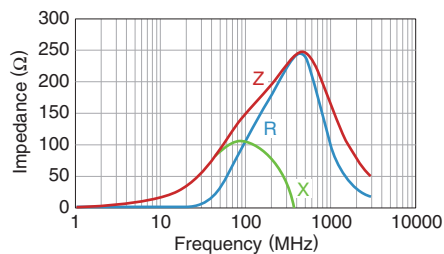

MPZ1608Y221BTA00

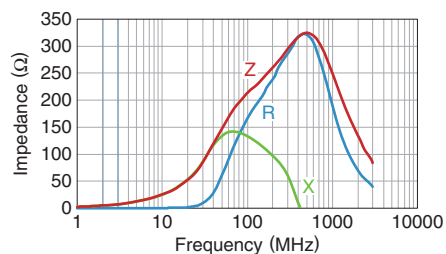

MPZ1608D300BTA00

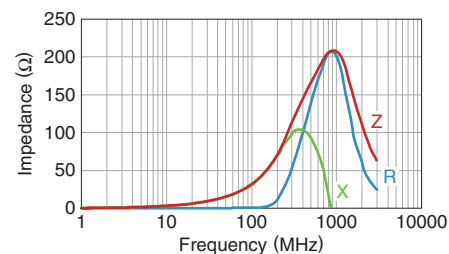

MPZ1608D600BTA00

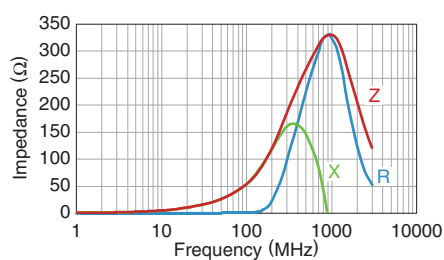

MPZ1608D101BTA00

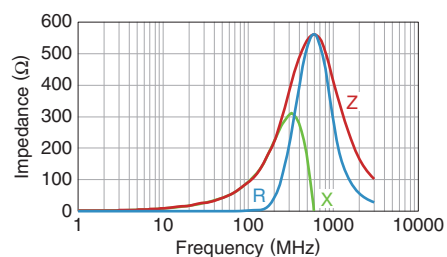

MPZ1608 type

PACKAGING STYLE

REEL DIMENSIONS

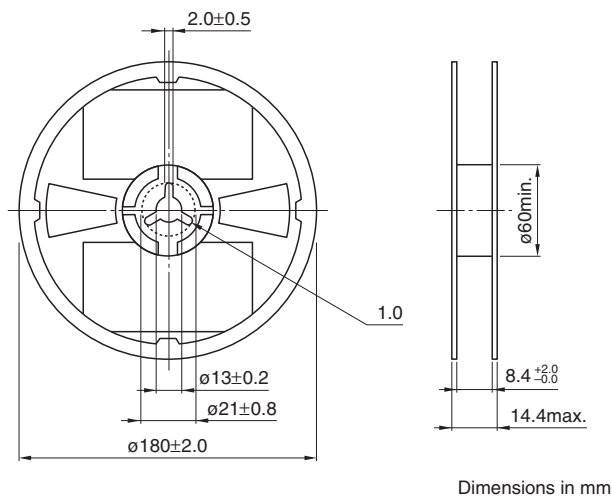

TAPE DIMENSIONS

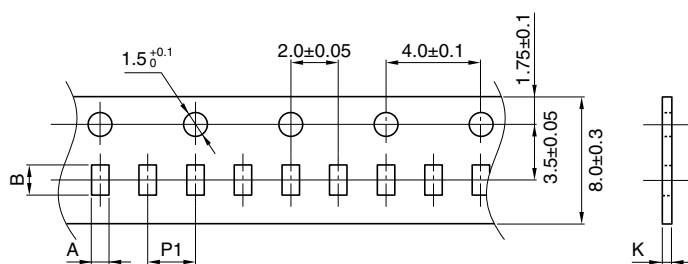

Type	A	B	P1	K
MPZ1608	1.1±0.2	1.9±0.2	4.0±0.1	1.1max.

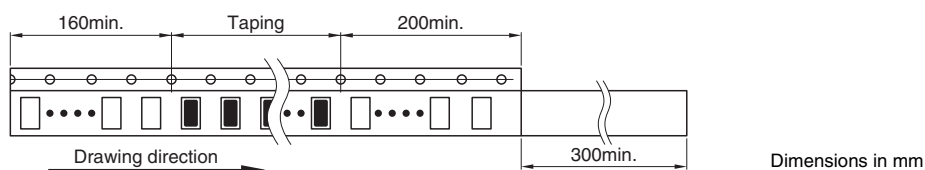

 Please be sure to request delivery specifications that provide further details on the features and specifications of the products for proper and safe use. Please note that the contents may change without any prior notice due to reasons such as upgrading.