



Inductors for High Frequency Circuits

Multilayer Ceramic

MLK Series

MLK0603_{Type}

MLK0603

0603 [0201 inch]*

* Dimensions Code JIS[EIA]

REMINDERS FOR USING THESE PRODUCTS

Before using these products, be sure to request the delivery specifications.

SAFETY REMINDERS

Please pay sufficient attention to the warnings for safe designing when using these products.

REMINDERS

- The storage period is less than 12 months. Be sure to follow the storage conditions (Temperature: 5 to 40°C, Humidity: 10 to 75% RH or less).
If the storage period elapses, the soldering of the terminal electrodes may deteriorate.
- Do not use or store in locations where there are conditions such as gas corrosion (salt, acid, alkali, etc.).
- Before soldering, be sure to preheat components.
The preheating temperature should be set so that the temperature difference between the solder temperature and chip temperature does not exceed 150°C.
- Soldering corrections after mounting should be within the range of the conditions determined in the specifications.
If overheated, a short circuit, performance deterioration, or lifespan shortening may occur.
- When embedding a printed circuit board where a chip is mounted to a set, be sure that residual stress is not given to the chip due to the overall distortion of the printed circuit board and partial distortion such as at screw tightening portions.
- Self heating (temperature increase) occurs when the power is turned ON, so the tolerance should be sufficient for the set thermal design.
- Carefully lay out the coil for the circuit board design of the non-magnetic shield type.
A malfunction may occur due to magnetic interference.
- Use a wrist band to discharge static electricity in your body through the grounding wire.
- Do not expose the products to magnets or magnetic fields.
- Do not use for a purpose outside of the contents regulated in the delivery specifications.
- The products listed on this catalog are intended for use in general electronic equipment (AV equipment, telecommunications equipment, home appliances, amusement equipment, computer equipment, personal equipment, office equipment, measurement equipment, industrial robots) under a normal operation and use condition.
The products are not designed or warranted to meet the requirements of the applications listed below, whose performance and/or quality require a more stringent level of safety or reliability, or whose failure, malfunction or trouble could cause serious damage to society, person or property.
If you intend to use the products in the applications listed below or if you have special requirements exceeding the range or conditions set forth in the each catalog, please contact us.

- (1) Aerospace/Aviation equipment
- (2) Transportation equipment (cars, electric trains, ships, etc.)
- (3) Medical equipment
- (4) Power-generation control equipment
- (5) Atomic energy-related equipment
- (6) Seabed equipment
- (7) Transportation control equipment

- (8) Public information-processing equipment
- (9) Military equipment
- (10) Electric heating apparatus, burning equipment
- (11) Disaster prevention/crime prevention equipment
- (12) Safety equipment
- (13) Other applications that are not considered general-purpose applications

When designing your equipment even for general-purpose applications, you are kindly requested to take into consideration securing protection circuit/device or providing backup circuits in your equipment.

Inductors for High Frequency Circuits

Multilayer Ceramic

Product compatible with RoHS directive
Halogen-free
Compatible with lead-free solders

Overview of MLK0603 Type

FEATURES

- With the adoption of a giga-spiral laminated structure, a self-resonant frequency higher than that of the MLG structure can be obtained, while the decrease of Q in the GHz band is limited.
- Monolithic structure is formed using a multilayering and sintering process with ceramic and conductive materials for high-frequency.
- There is no directivity.

APPLICATION

Smart phones, tablet terminals, high frequency modules (PAs, VCOs, FEMs , etc.), Bluetooth, W-LAN, UWB, tuners and other high frequency circuits for the mobile communication industry

PART NUMBER CONSTRUCTION

MLK	0603		L	1N0		S	T		000
Series name	LxWxH Dimensions (mm)		Characteristics	Inductance (nH)		Inductance tolerance		Packaging style	Internal code
	0603	0.6x0.3x0.3	L	1N1	1.1	S	±0.3nH	T	Taping
				11N	11	J	±5%		000

OPERATING TEMPERATURE RANGE, PACKAGE QUANTITY, PRODUCT WEIGHT

Type	Temperature range		Package quantity (pieces/reel)	Individual weight (mg)
	Operating temperature (°C)	Storage temperature* (°C)		
MLK0603	-55 to +125	-55 to +125	15000	0.2

* The Storage temperature range is for after the circuit board is mounted.

- RoHS Directive Compliant Product: See the following for more details related to RoHS Directive compliant products. <http://product.tdk.com/en/environment/rohs/>
- Halogen-free: Indicates that Cl content is less than 900ppm, Br content is less than 900ppm, and that the total Cl and Br content is less than 1500ppm.

 Please be sure to request delivery specifications that provide further details on the features and specifications of the products for proper and safe use. Please note that the contents may change without any prior notice due to reasons such as upgrading.

MLK0603 Type

RECOMMENDED REFLOW PROFILE

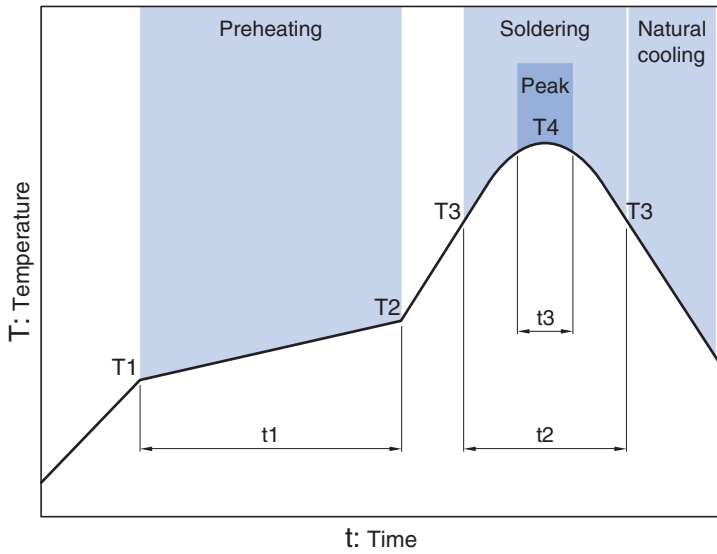

Preheating			Soldering		Peak	
Temp.	Time		Temp.	Time	Temp.	Time
T1	T2	t1	T3	t2	T4	t3
150°C	180°C	60 to 120s	230°C	30 to 60s	250 to 260°C	10s max.

 Please be sure to request delivery specifications that provide further details on the features and specifications of the products for proper and safe use. Please note that the contents may change without any prior notice due to reasons such as upgrading.

MLK0603 Type

SHAPE & DIMENSIONS

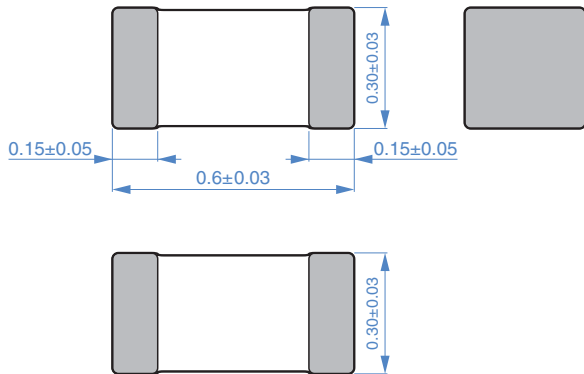

Dimensions in mm

RECOMMENDED LAND PATTERN

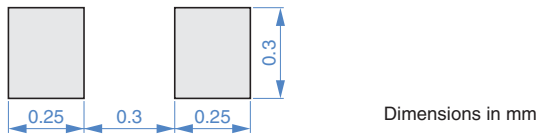

Dimensions in mm

MLK0603 Type

ELECTRICAL CHARACTERISTICS

CHARACTERISTICS SPECIFICATION TABLE

L (nH)	Tolerance	L measuring frequency (MHz)	Q min.	Q measuring frequency (MHz)	Self-resonant frequency		DC resistance		Rated current (mA)max.	Part No.
					(GHz)min.	(GHz)typ.	(Ω)max.	(Ω)typ.		
1.0	± 0.3 nH	100	6	300	12.0	17.1	0.20	0.09	300	MLK0603L1N0ST000
1.1	± 0.3 nH	100	6	300	11.0	17.1	0.22	0.10	300	MLK0603L1N1ST000
1.2	± 0.3 nH	100	6	300	11.0	16.1	0.22	0.11	300	MLK0603L1N2ST000
1.3	± 0.3 nH	100	6	300	10.0	15.8	0.24	0.12	300	MLK0603L1N3ST000
1.5	± 0.3 nH	100	6	300	10.0	14.9	0.24	0.12	300	MLK0603L1N5ST000
1.6	± 0.3 nH	100	6	300	10.0	14.3	0.27	0.13	300	MLK0603L1N6ST000
1.8	± 0.3 nH	100	6	300	10.0	13.8	0.27	0.14	300	MLK0603L1N8ST000
2.0	± 0.3 nH	100	6	300	9.0	12.6	0.30	0.15	300	MLK0603L2N0ST000
2.2	± 0.3 nH	100	6	300	9.0	12.5	0.30	0.17	300	MLK0603L2N2ST000
2.4	± 0.3 nH	100	6	300	8.5	11.4	0.35	0.17	300	MLK0603L2N4ST000
2.7	± 0.3 nH	100	6	300	8.5	10.9	0.35	0.18	300	MLK0603L2N7ST000
3.0	± 0.3 nH	100	6	300	8.0	10.6	0.40	0.20	200	MLK0603L3N0ST000
3.3	± 0.3 nH	100	6	300	8.0	10.5	0.40	0.22	200	MLK0603L3N3ST000
3.6	± 0.3 nH	100	6	300	8.0	9.9	0.45	0.22	200	MLK0603L3N6ST000
3.9	± 0.3 nH	100	6	300	8.0	9.8	0.45	0.25	200	MLK0603L3N9ST000
4.3	± 0.3 nH	100	6	300	7.5	9.5	0.50	0.28	200	MLK0603L4N3ST000
4.7	± 0.3 nH	100	6	300	7.5	9.5	0.50	0.28	200	MLK0603L4N7ST000
5.1	± 0.3 nH	100	6	300	6.5	8.8	0.60	0.28	200	MLK0603L5N1ST000
5.6	± 0.3 nH	100	6	300	6.5	8.5	0.60	0.30	200	MLK0603L5N6ST000
6.2	± 0.3 nH	100	6	300	6.0	8.3	0.65	0.34	200	MLK0603L6N2ST000
6.8	$\pm 5\%$	100	6	300	6.0	8.1	0.65	0.34	200	MLK0603L6N8JT000
7.5	$\pm 5\%$	100	6	300	6.0	7.7	0.70	0.36	200	MLK0603L7N5JT000
8.2	$\pm 5\%$	100	6	300	6.0	7.9	0.70	0.41	200	MLK0603L8N2JT000
9.1	$\pm 5\%$	100	6	300	5.5	7.4	0.80	0.42	200	MLK0603L9N1JT000
10	$\pm 5\%$	100	6	300	5.5	7.5	0.80	0.48	200	MLK0603L10NJT000
12	$\pm 5\%$	100	6	300	5.0	6.9	1.00	0.54	150	MLK0603L12NJT000
15	$\pm 5\%$	100	6	300	4.5	6.6	1.10	0.66	150	MLK0603L15NJT000
18	$\pm 5\%$	100	6	300	4.0	5.8	1.30	0.85	100	MLK0603L18NJT000
22	$\pm 5\%$	100	6	300	3.5	5.3	1.60	1.02	100	MLK0603L22NJT000
27	$\pm 5\%$	100	6	300	3.0	4.6	1.70	1.09	100	MLK0603L27NJT000
33	$\pm 5\%$	100	6	300	2.8	4.4	1.80	1.21	100	MLK0603L33NJT000

Measurement equipment

Measurement item	Product No.	Manufacturer
L, Q	4291B+16197A	Agilent Technologies
Self-resonant frequency	8720C	Agilent Technologies
DC resistance	Type-7561	Yokogawa

* Equivalent measurement equipment may be used.

MLK0603 Type

ELECTRICAL CHARACTERISTICS

L, Q FREQUENCY CHARACTERISTICS TABLE

L(nH)typ.					Q typ.					Part No.
500MHz	800MHz	1.8GHz	2.0GHz	2.4GHz	500MHz	800MHz	1.8GHz	2.0GHz	2.4GHz	
0.9	0.9	0.9	0.9	0.9	10	12	19	20	22	MLK0603L1N0ST000
1.0	1.0	0.9	0.9	0.9	9	11	17	18	20	MLK0603L1N1ST000
1.1	1.0	1.0	1.0	1.0	9	12	18	19	21	MLK0603L1N2ST000
1.2	1.1	1.1	1.1	1.1	9	12	18	19	21	MLK0603L1N3ST000
1.3	1.3	1.3	1.3	1.3	9	12	18	19	21	MLK0603L1N5ST000
1.4	1.4	1.4	1.4	1.4	9	12	18	19	21	MLK0603L1N6ST000
1.6	1.6	1.6	1.6	1.6	9	11	17	18	20	MLK0603L1N8ST000
1.8	1.7	1.7	1.7	1.7	9	12	17	18	20	MLK0603L2N0ST000
2.0	1.9	1.9	1.9	2.0	10	12	19	20	22	MLK0603L2N2ST000
2.1	2.1	2.1	2.1	2.1	9	12	18	19	20	MLK0603L2N4ST000
2.4	2.4	2.4	2.4	2.4	10	13	19	20	22	MLK0603L2N7ST000
2.7	2.6	2.6	2.6	2.7	9	12	18	19	21	MLK0603L3N0ST000
3.0	2.9	2.9	3.0	3.0	10	13	19	20	22	MLK0603L3N3ST000
3.2	3.1	3.1	3.1	3.2	9	11	17	18	19	MLK0603L3N6ST000
3.5	3.4	3.5	3.5	3.5	10	13	19	20	22	MLK0603L3N9ST000
3.8	3.8	3.8	3.8	3.9	10	12	18	19	20	MLK0603L4N3ST000
4.2	4.2	4.2	4.2	4.3	10	13	19	20	22	MLK0603L4N7ST000
4.6	4.5	4.5	4.6	4.7	10	12	18	19	21	MLK0603L5N1ST000
5.0	5.0	5.0	5.0	5.1	10	12	18	19	21	MLK0603L5N6ST000
5.5	5.5	5.5	5.6	5.7	10	12	18	19	20	MLK0603L6N2ST000
6.2	6.1	6.2	6.2	6.4	10	13	19	20	22	MLK0603L6N8JT000
6.7	6.6	6.7	6.8	7.0	10	12	18	19	20	MLK0603L7N5JT000
7.4	7.3	7.5	7.6	7.8	10	13	19	20	21	MLK0603L8N2JT000
8.2	8.1	8.3	8.4	8.6	10	12	18	18	20	MLK0603L9N1JT000
9.0	8.9	9.2	9.3	9.6	10	13	18	19	20	MLK0603L10NJT000
10.8	10.6	11.0	11.2	11.6	10	12	18	18	20	MLK0603L12NJT000
13.5	13.4	13.9	14.2	14.8	10	12	17	18	19	MLK0603L15NJT000
16.2	16.1	17.0	17.4	18.4	10	12	16	17	18	MLK0603L18NJT000
19.8	19.7	20.9	21.5	22.8	10	12	16	16	17	MLK0603L22NJT000
24.4	24.4	27.2	28.6	31.7	10	12	15	15	14	MLK0603L27NJT000
29.7	29.7	33.4	35.1	39.3	9	11	14	14	13	MLK0603L33NJT000

○ Measurement equipment

Product No.	Manufacturer
4291B+16197A	Agilent Technologies

* Equivalent measurement equipment may be used.

MLK0603 Type

ELECTRICAL CHARACTERISTICS

L FREQUENCY CHARACTERISTICS GRAPH (EXAMPLE)

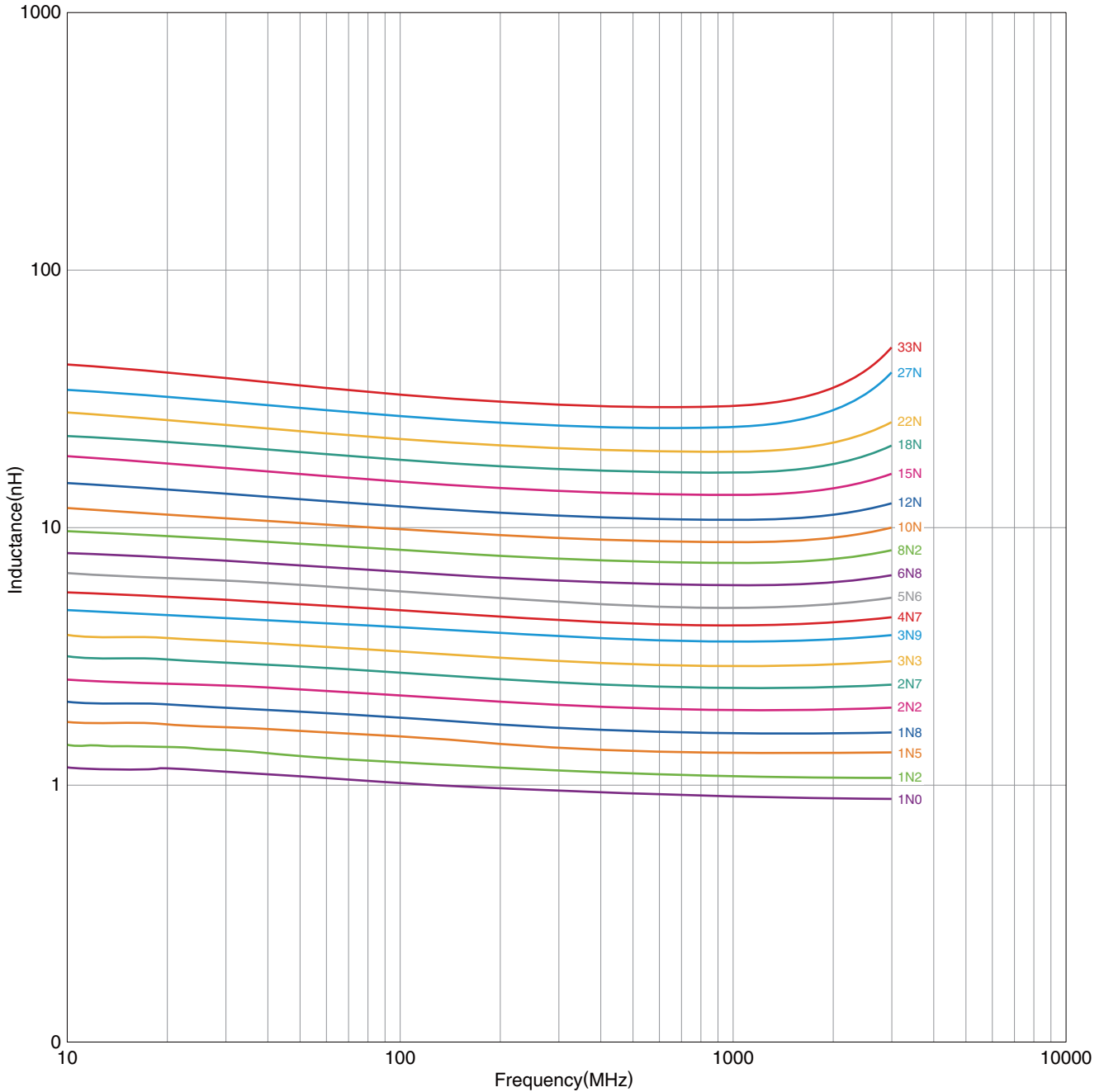

○ Measurement equipment

Product No.	Manufacturer
E4991A+16197A	Agilent Technologies

* Equivalent measurement equipment may be used.

 Please be sure to request delivery specifications that provide further details on the features and specifications of the products for proper and safe use. Please note that the contents may change without any prior notice due to reasons such as upgrading.

MLK0603 Type

ELECTRICAL CHARACTERISTICS

Q FREQUENCY CHARACTERISTICS GRAPH (EXAMPLE)

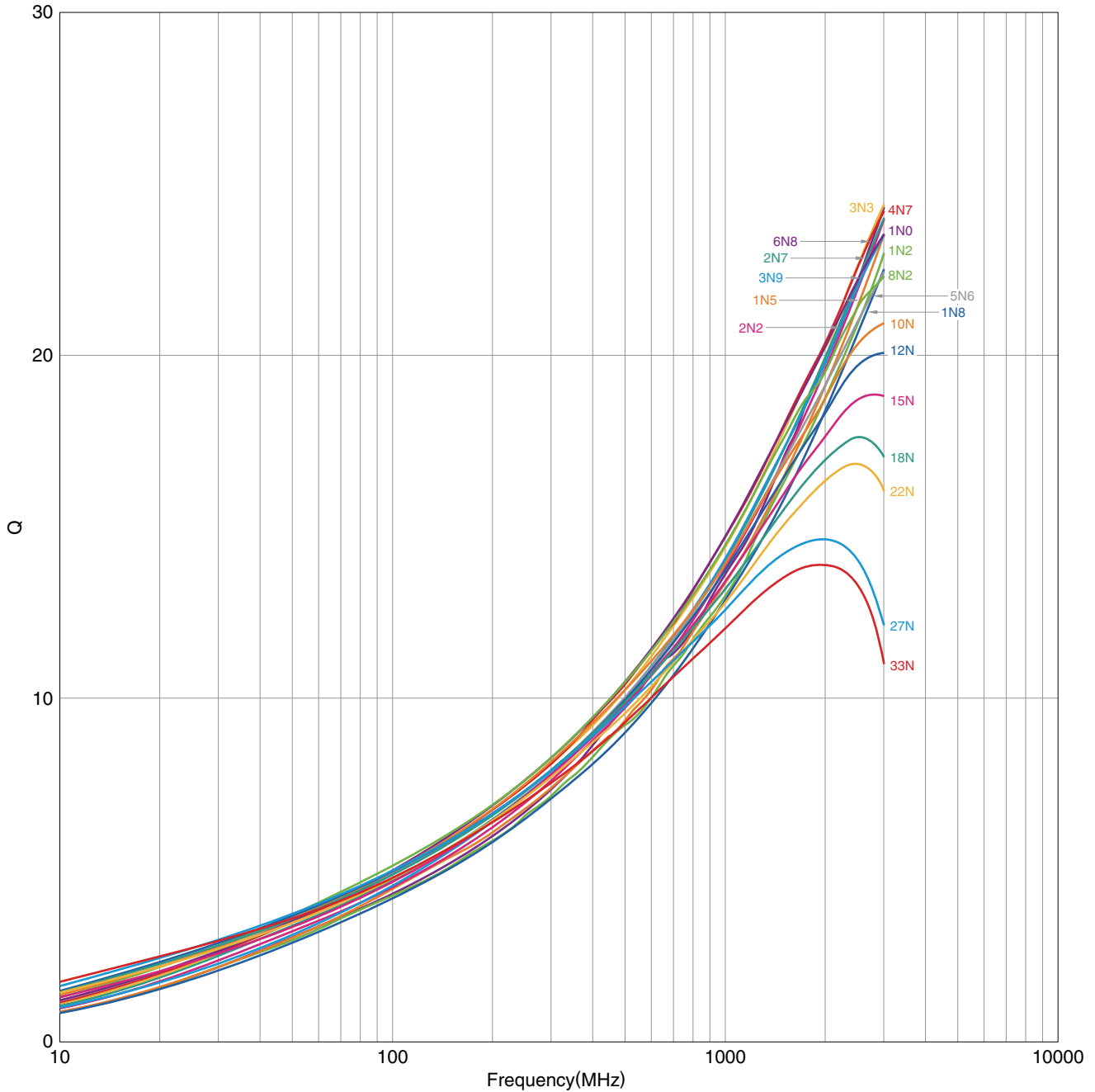

○ Measurement equipment

Product No.	Manufacturer
E4991A+16197A	Agilent Technologies

* Equivalent measurement equipment may be used.

 Please be sure to request delivery specifications that provide further details on the features and specifications of the products for proper and safe use. Please note that the contents may change without any prior notice due to reasons such as upgrading.

MLK0603 Type

PACKAGING STYLE

REEL DIMENSIONS



TAPE DIMENSIONS

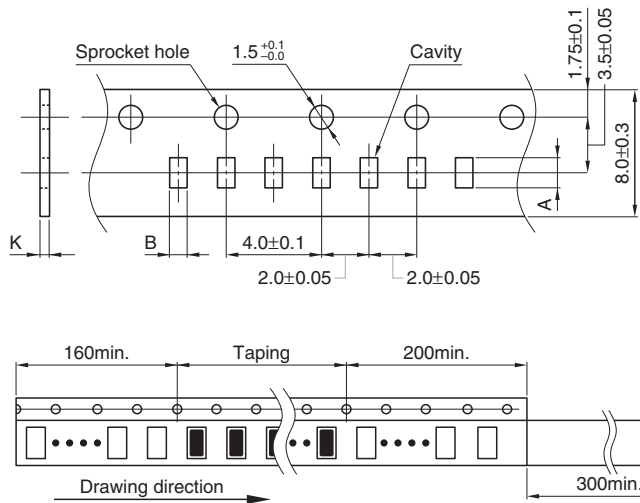

Type	A	B	K
MLK0603	0.68±0.05	0.38±0.05	0.5 max.

 Please be sure to request delivery specifications that provide further details on the features and specifications of the products for proper and safe use. Please note that the contents may change without any prior notice due to reasons such as upgrading.