



## 3-terminal Filters

For Power Line

# YFF-P Series

---

<b>YFF15PC</b>	<b>1005 [0402 inch]*</b>	<b>Feed through filter</b>
<b>YFF18PC</b>	<b>1608 [0603 inch]*</b>	<b>Feed through filter</b>
<b>YFF18PH</b>	<b>1608 [0603 inch]*</b>	<b>Feed through filter (Thickness: 0.8mm)</b>
<b>YFF18PW</b>	<b>1608 [0603 inch]*</b>	<b>Feed through filter (Low ESL)</b>
<b>YFF21PC</b>	<b>2012 [0805 inch]*</b>	<b>Feed through filter</b>
<b>YFF31PC</b>	<b>3216 [1206 inch]*</b>	<b>Feed through filter</b>

\* Dimensions Code JIS[EIA]

---

# 3-terminal Filters

Conformity to RoHS Directive  
Lead-free Compatible

## For Power Line

# Overview of YFF-P Series

### FEATURES

- Small and high-performance EMC components.
- Good attenuation characteristic in a wide band range.
- For large current (2A to 4A) applications

### APPLICATIONS

For the power line of communication terminal devices, such as a smart phone, and AV and information devices.

### PART NUMBER IDENTIFICATION

YFF		15		PC		0G		435		M		T		□□		0		N	
Series name	L×W dimensions		Product internal code		Rated voltage		Capacitance		Tolerance		Taping	TDK internal code	Reel size		Internal electrode Ni				
	Code	mm			Code	V	Code	pF					Code	mm					
	15	1.0×0.5	PC	STD	0G	4	104	100,000	M	±20%			0	ø178					
	18	1.6×0.8	PH	Thickness: 0.8mm	0J	6.3	105	1,000,000 (1.0μF)					9	ø330					
	21	2.0×1.2	PW	Low ESL	1A	10	225	2,200,000 (2.2μF)											
	31	3.2×1.6			1C	16			226	22,000,000 (22μF)									
					1E	25													
					1H	50													

### PACKAGING STYLE AND SPECIFICATIONS

Type	Package quantity (piece/reel)		Single weight (g)
	ø178	ø330	
YFF15PC	10,000	50,000	0.0008*
YFF18PC	4,000	10,000	0.0038
YFF18PH	4,000	10,000	0.0051
YFF18PW	4,000	10,000	0.0038
YFF21PC	4,000	10,000	0.0095
YFF31PC	2,000	10,000	0.0342

\* In the case of YFF15PC0G435M, the weight is 0.0015g.

- Conformity to RoHS Directive: This means that, in conformity with EU Directive 2002/95/EC, lead, cadmium, mercury, hexavalent chromium, and specific bromine-based flame retardants, PBB and PBDE, have not been used, except for exempted applications.
- Please contact our Sales office when your application is considered the following:  
The device's failure or malfunction may directly endanger human life (e.g. application for automobile/aircraft/medical/nuclear power devices, etc.)

 Please be sure to request delivery specifications that provide further details on the features and specifications of the products for proper and safe use. Please note that the contents may change without any prior notice due to reasons such as upgrading.

# Overview of YFF-P Series

## RECOMMENDED SOLDERING CONDITION

### REFLOW SOLDERING

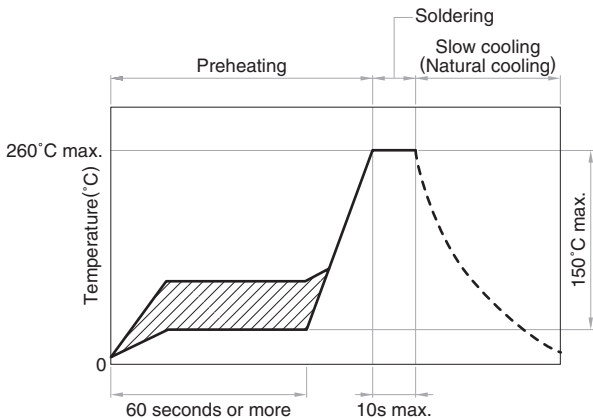

### HAND SOLDERING

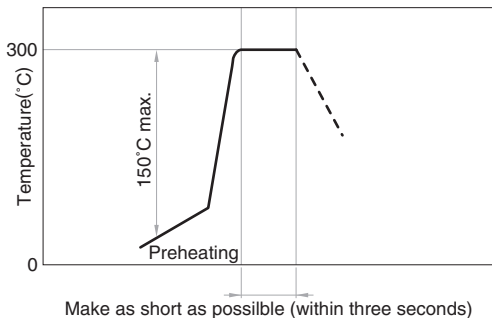

## PRECAUTIONS FOR USE

- Before soldering, be sure to preheat components. The  $\Delta T$  preheating temperature must be 150°C max. with attention paid to thermal shock.
- Natural cooling of components in the air is recommended. On the other hand, when dipping them in a solvent for purposes, such as cleaning, make sure that the temperature difference ( $\Delta T$ ) is 100°C.
- When performing hand soldering for circuit modification, apply the soldering iron to the copper foil area of the printed circuit board for 3 seconds or less. The temperature of the iron tip should not exceed 300°C.
- Use a wrist band to discharge static electricity in your body through the grounding wire.
- When incorporating the printed circuit board on which this product is mounted into a frame, etc., do not apply stress to the product through local bending of the board by tightening of screws, etc.

 Please be sure to request delivery specifications that provide further details on the features and specifications of the products for proper and safe use. Please note that the contents may change without any prior notice due to reasons such as upgrading.

# YFF-P Series YFF15PC Type(Feed Through Filter)

## SHAPES AND DIMENSIONS

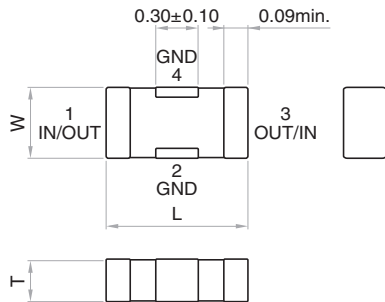

## RECOMMENDED LAND PATTERN

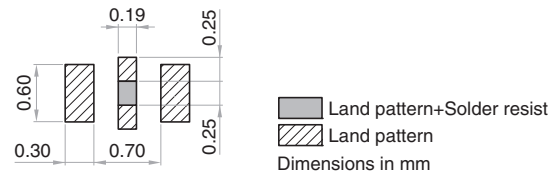

Part No.	L	W	T
YFF15PC0G435MT00□N	1.05±0.05	0.65±0.05	0.45±0.05
YFF15PC0G105MT00□N	1.00±0.05	0.55±0.05	0.30±0.05
YFF15PC0J474MT00□N	1.00±0.05	0.55±0.05	0.30±0.05
YFF15PC1A224MT00□N	1.00±0.05	0.55±0.05	0.30±0.05
YFF15PC1C104MT00□N	1.00±0.05	0.55±0.05	0.30±0.05

\* Make sure to connect the GND terminal of this product and the GND of the mounting circuit board by using through holes so that the distance between them is the shortest.

## ELECTRICAL CHARACTERISTICS

### CHARACTERISTICS SPECIFICATION TABLE

Insertion loss 40dB bandwidth (MHz)	Rated voltage Edc (V)	Rated current Idc (A)	Operating temperature range (°C)	Storage temperature range(After mount) (°C)	Part No.*
0.2 to 1000	4	2	-55 to 85	-55 to 85	YFF15PC0G435MT00□N
0.8 to 1000	4	3	-55 to 105	-55 to 105	YFF15PC0G105MT00□N
2 to 1000	6.3	3	-55 to 105	-55 to 105	YFF15PC0J474MT00□N
4 to 1000	10	3	-55 to 105	-55 to 105	YFF15PC1A224MT00□N
9 to 1000	16	3	-55 to 105	-55 to 105	YFF15PC1C104MT00□N

\* The part numbers are TDK's standard specification products.

\* □: Please specify reel size code, 0 (ø178) or 9 (ø330)

## ELECTRICAL CHARACTERISTICS GRAPH

### INSERTION LOSS vs. FREQUENCY CHARACTERISTICS

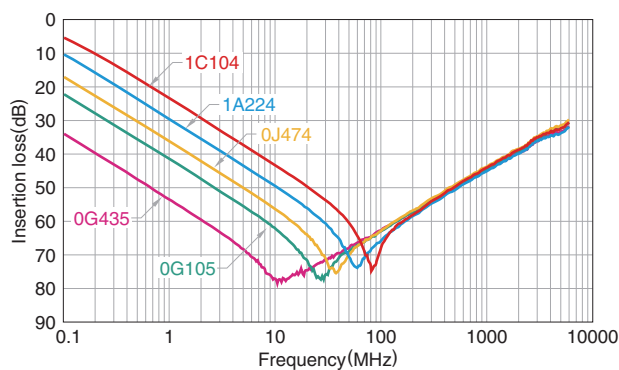

### RATED CURRENT vs. TEMPERATURE CHARACTERISTICS (DERATING)

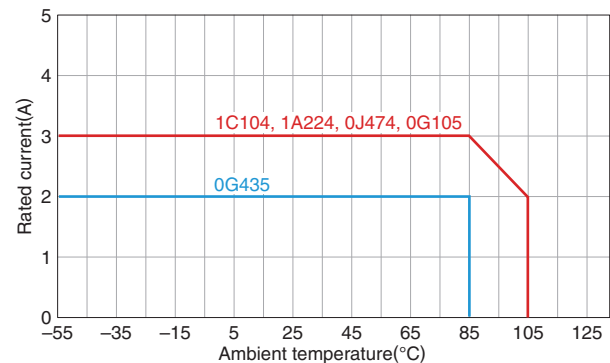

⚠ Please be sure to request delivery specifications that provide further details on the features and specifications of the products for proper and safe use. Please note that the contents may change without any prior notice due to reasons such as upgrading.

# YFF-P Series YFF18PC Type(Feed Through Filter)

## SHAPES AND DIMENSIONS

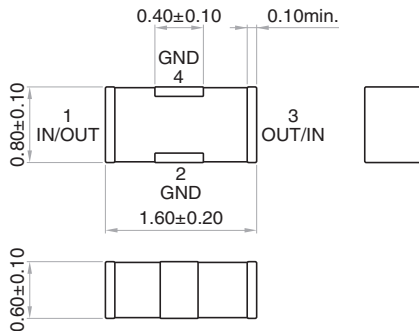

## RECOMMENDED LAND PATTERN

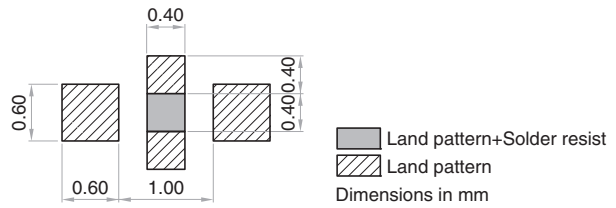

\* Make sure to connect the GND terminal of this product and the GND of the mounting circuit board by using through holes so that the distance between them is the shortest.

## ELECTRICAL CHARACTERISTICS

### CHARACTERISTICS SPECIFICATION TABLE

Insertion loss 40dB bandwidth (MHz)	Rated voltage Edc (V)	Rated current Idc (A)	Operating temperature range (°C)	Storage temperature range(After mount) (°C)	Part No.*
0.2 to 1000	6.3	4	-55 to 85	-55 to 85	YFF18PC0J475MT0H□N
0.8 to 1000	6.3	4	-55 to 105	-55 to 105	YFF18PC0J105MT0H□N
2 to 1000	6.3	4	-55 to 125	-55 to 125	YFF18PC0J474MT0H□N
3 to 1000	6.3	4	-55 to 125	-55 to 125	YFF18PC0J224MT0H□N
7 to 1000	16	4	-55 to 125	-55 to 125	YFF18PC1C104MT0H□N

\* The part numbers are TDK's standard specification products.

\* □: Please specify reel size code, 0 (ø178) or 9 (ø330)

## ELECTRICAL CHARACTERISTICS GRAPH

### INSERTION LOSS vs. FREQUENCY CHARACTERISTICS

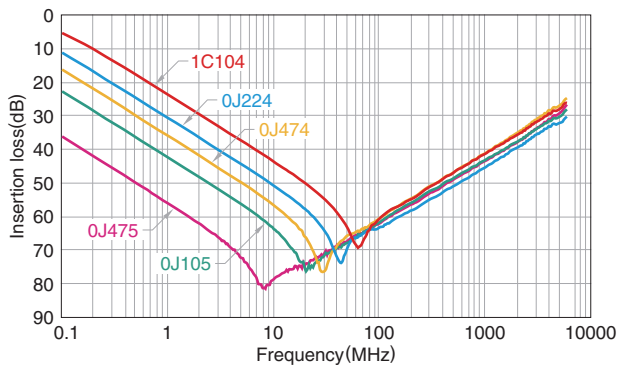

### RATED CURRENT vs. TEMPERATURE CHARACTERISTICS (DERATING)

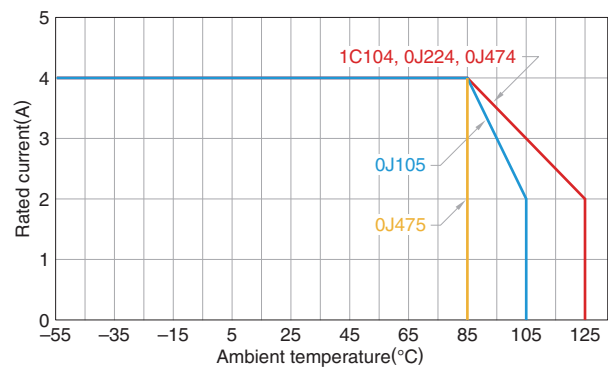

⚠ Please be sure to request delivery specifications that provide further details on the features and specifications of the products for proper and safe use. Please note that the contents may change without any prior notice due to reasons such as upgrading.

# YFF-P Series YFF18PH Type(Feed Through Filter)

## SHAPES AND DIMENSIONS

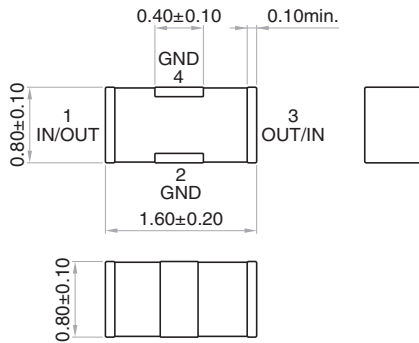

## RECOMMENDED LAND PATTERN

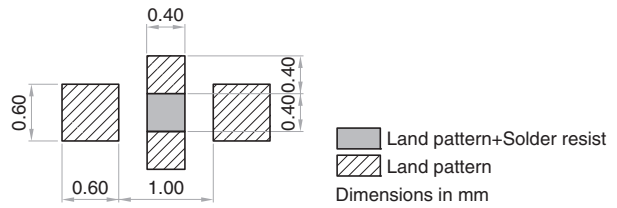

\* Make sure to connect the GND terminal of this product and the GND of the mounting circuit board by using through holes so that the distance between them is the shortest.

## ELECTRICAL CHARACTERISTICS

### CHARACTERISTICS SPECIFICATION TABLE

Insertion loss 40dB bandwidth (MHz)	Rated voltage E <sub>dc</sub> (V)	Rated current I <sub>dc</sub> (A)	Operating temperature range (°C)	Storage temperature range(After mount) (°C)	Part No.*
0.4 to 1000	6.3	4	-55 to 85	-55 to 85	YFF18PH0J225MT00□N
0.8 to 1000	6.3	4	-55 to 105	-55 to 105	YFF18PH0J105MT00□N

\* The part numbers are TDK's standard specification products.

\* □: Please specify reel size code, 0 (ø178) or 9 (ø330)

## ELECTRICAL CHARACTERISTICS GRAPH

### INSERTION LOSS vs. FREQUENCY CHARACTERISTICS

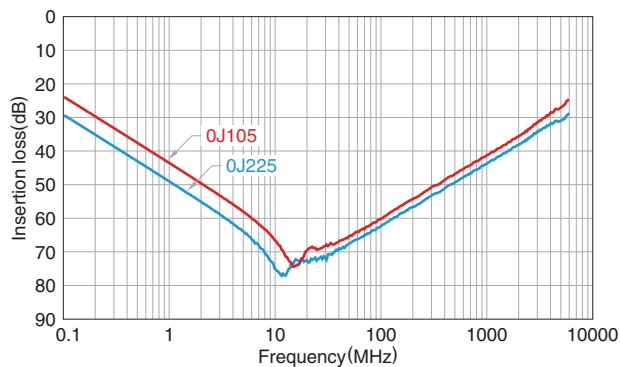

### RATED CURRENT vs. TEMPERATURE CHARACTERISTICS (DERATING)

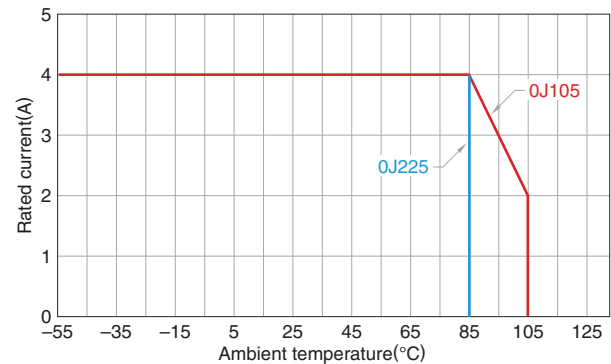

⚠ Please be sure to request delivery specifications that provide further details on the features and specifications of the products for proper and safe use. Please note that the contents may change without any prior notice due to reasons such as upgrading.

# YFF-P Series YFF18PW Type(Feed Through Filter)

## SHAPES AND DIMENSIONS

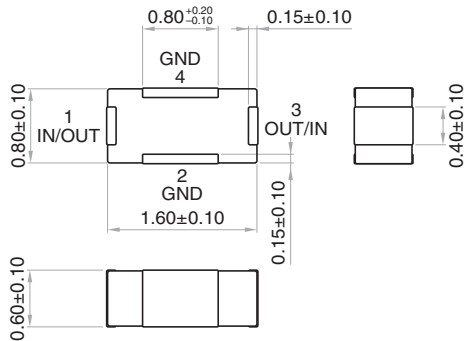

## RECOMMENDED LAND PATTERN

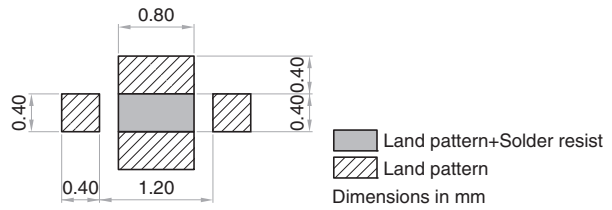

\* Make sure to connect the GND terminal of this product and the GND of the mounting circuit board by using through holes so that the distance between them is the shortest.

## ELECTRICAL CHARACTERISTICS

### CHARACTERISTICS SPECIFICATION TABLE

Insertion loss 40dB bandwidth (MHz)	Rated voltage E <sub>dc</sub> (V)	Rated current I <sub>dc</sub> (A)	Operating temperature range (°C)	Storage temperature range(After mount) (°C)	Part No.*
0.2 to 2000	6.3	4	-55 to 85	-55 to 85	YFF18PW0J475MT0H□N
0.8 to 2000	6.3	4	-55 to 105	-55 to 105	YFF18PW0J105MT0H□N
2 to 2000	6.3	4	-55 to 125	-55 to 125	YFF18PW0J474MT0H□N

\* The part numbers are TDK's standard specification products.

\* □: Please specify reel size code, 0 (ø178) or 9 (ø330)

## ELECTRICAL CHARACTERISTICS GRAPH

### INSERTION LOSS vs. FREQUENCY CHARACTERISTICS

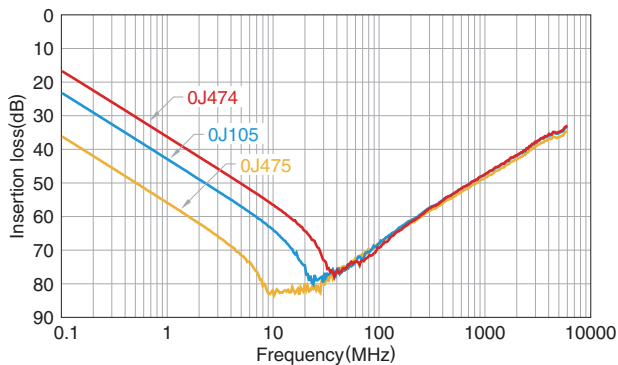

### RATED CURRENT vs. TEMPERATURE CHARACTERISTICS (DERATING)

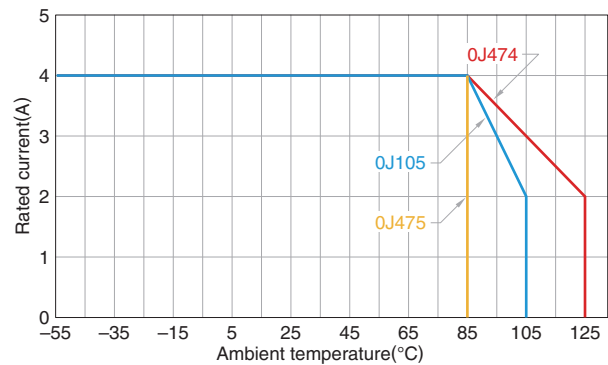

# YFF-P Series YFF21PC Type(Feed Through Filter)

## SHAPES AND DIMENSIONS

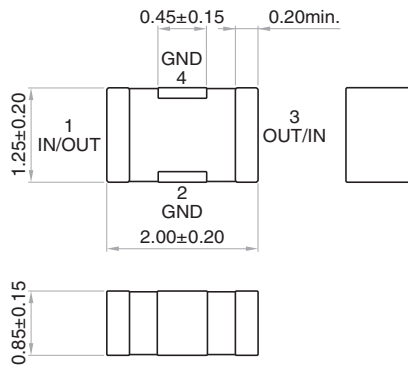

## RECOMMENDED LAND PATTERN

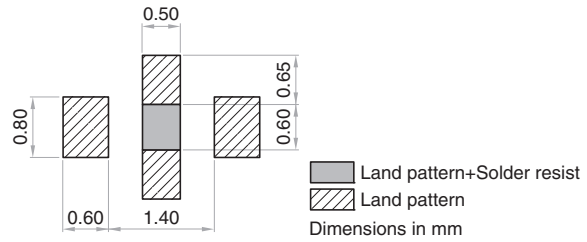

\* Make sure to connect the GND terminal of this product and the GND of the mounting circuit board by using through holes so that the distance between them is the shortest.

## ELECTRICAL CHARACTERISTICS

### CHARACTERISTICS SPECIFICATION TABLE

Insertion loss 40dB bandwidth (MHz)	Rated voltage Edc (V)	Rated current Idc (A)	Operating temperature range (°C)	Storage temperature range(After mount) (°C)	Part No.*
0.04 to 1000	6.3	4	-55 to 85	-55 to 85	YFF21PC0J226MT00□N
0.08 to 1000	6.3	4	-55 to 85	-55 to 85	YFF21PC0J106MT00□N
0.2 to 1000	10	3	-55 to 85	-55 to 85	YFF21PC1A475MT00□N
0.3 to 1000	10	2	-55 to 85	-55 to 85	YFF21PC1A225MT00□N
0.7 to 1000	10	4	-55 to 85	-55 to 85	YFF21PC1A105MT00□N
2 to 1000	16	2	-55 to 125	-55 to 125	YFF21PC1C474MT00□N
7 to 1000	25	2	-55 to 125	-55 to 125	YFF21PC1E104MT00□N

\* The part numbers are TDK's standard specification products.

\* □: Please specify reel size code, 0 (ø178) or 9 (ø330)

## ELECTRICAL CHARACTERISTICS GRAPH

### INSERTION LOSS vs. FREQUENCY CHARACTERISTICS

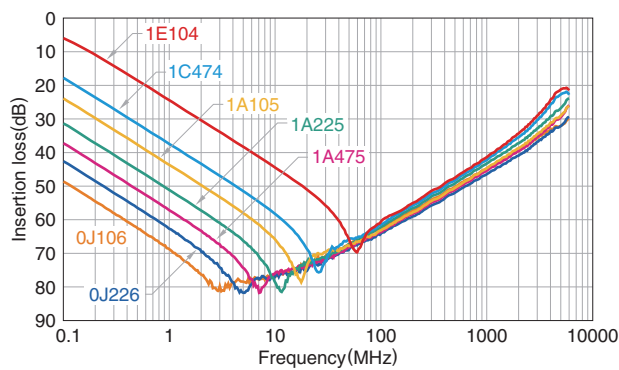

⚠ Please be sure to request delivery specifications that provide further details on the features and specifications of the products for proper and safe use. Please note that the contents may change without any prior notice due to reasons such as upgrading.



# YFF-P Series YFF31PC Type(Feed Through Filter)

## SHAPES AND DIMENSIONS

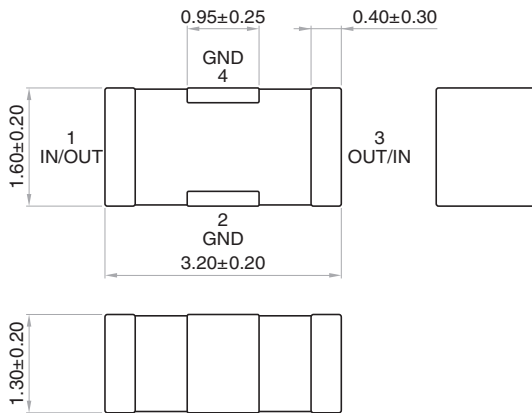

## RECOMMENDED LAND PATTERN

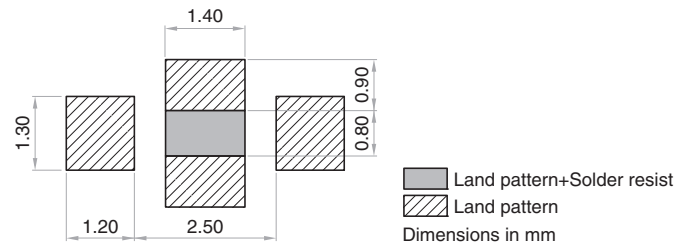

\* Make sure to connect the GND terminal of this product and the GND of the mounting circuit board by using through holes so that the distance between them is the shortest.

## ELECTRICAL CHARACTERISTICS

### CHARACTERISTICS SPECIFICATION TABLE

Insertion loss 40dB bandwidth (MHz)	Rated voltage E <sub>dc</sub> (V)	Rated current I <sub>dc</sub> (A)	Operating temperature range (°C)	Storage temperature range(After mount) (°C)	Part No.*
0.04 to 1000	6.3	4	-55 to 85	-55 to 85	YFF31PC0J226MT00□N
0.7 to 1000	16	2	-55 to 125	-55 to 125	YFF31PC1C105MT00□N
2 to 1000	16	2	-55 to 125	-55 to 125	YFF31PC1C474MT00□N
3 to 600	16	2	-55 to 125	-55 to 125	YFF31PC1C224MT00□N
7 to 1000	16	2	-55 to 125	-55 to 125	YFF31PC1C104MT00□N

\* The part numbers are TDK's standard specification products.

\* □: Please specify reel size code, 0 (ø178) or 9 (ø330)

## ELECTRICAL CHARACTERISTICS GRAPH

### INSERTION LOSS vs. FREQUENCY CHARACTERISTICS

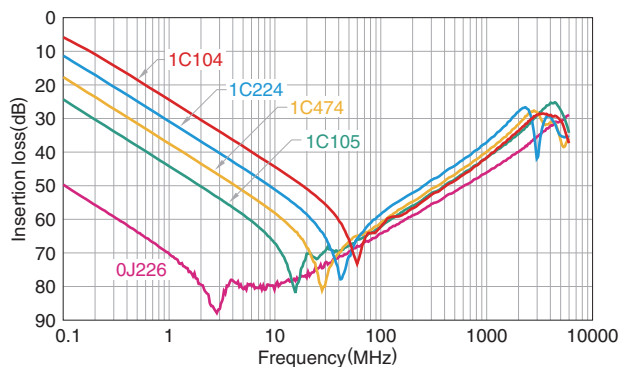

# YFF-P Series Packing Style

## REEL DIMENSIONS

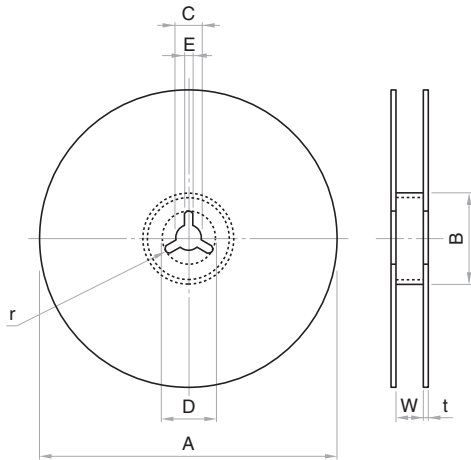

Dimensions in mm

Reel	A	B	C	D	E	W	t	r
ø178	ø178±2.0	ø60±2.0	ø13±0.5	ø21±0.8	2.0±0.5	9.0±0.3	2.0±0.05	1.0
ø330	ø382 max.(ø330 nom.)	ø50 min.	ø13±0.5	ø21±0.8	2.0±0.5	10.0±1.5	2.0±0.05	1.0

## TAPE DIMENSIONS

### Paper tape

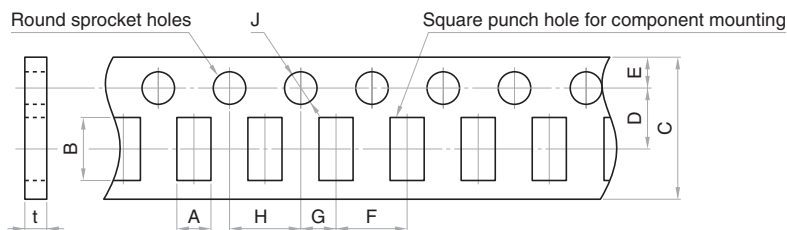

Dimensions in mm

Type	A	B	C	D	E	F	G	H	J	t
YFF15PC	0.62 typ. (0.75 typ.)*	1.12 typ. (1.18 typ.)*	8.0±0.3	3.5±0.05	1.75±0.1	2.0±0.05	2.0±0.05	4.0±0.1	ø1.5+0.1/-0	0.7 max.
YFF18PC										
YFF18PH	1.10 typ.	1.90 typ.	8.0±0.3	3.5±0.05	1.75±0.1	4.0±0.1	2.0±0.05	4.0±0.1	ø1.5+0.1/-0	1.1 max.
YFF18PW										
YFF21PC	1.50 typ.	2.30 typ.	8.0±0.3	3.5±0.05	1.75±0.1	4.0±0.1	2.0±0.05	4.0±0.1	ø1.5+0.1/-0	1.1 max.

\* Applies to YFF15PC0G435M

### Plastic tape

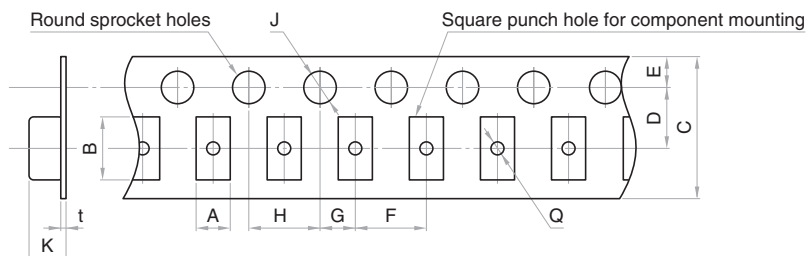

Dimensions in mm

Type	A	B	C	D	E	F	G	H	J	K	t	Q
YFF31PC	1.90 typ.	3.50 typ.	8.0±0.3	3.5±0.05	1.75±0.1	4.00±0.1	2.0±0.05	4.00±0.1	ø1.5+0.1/-0	2.50 max.	0.30 max.	ø0.50 max.

⚠ Please be sure to request delivery specifications that provide further details on the features and specifications of the products for proper and safe use. Please note that the contents may change without any prior notice due to reasons such as upgrading.