

Multilayer Band Pass Filters

For 2.4GHz W-LAN/Bluetooth

DEA Series

Type: **DEA252450BT-2080B2 (2.5×2.0×0.9mm)**
 DEA252450BT-2024C2 (2.5×2.0×0.9mm)
 DEA252450BT-2024C5 (2.5×2.0×1.0mm max.)
 DEA252400BT-2030A1 (2.5×2.0×1.0mm max.)
 DEA252450BT-2024D4 (2.5×2.0×1.0mm max.)
 DEA252450BT-2027A1 (2.5×2.0×1.0mm max.)
 DEA252450BT-2031A1 (2.5×2.0×1.0mm max.)
 DEA252450BT-2063C1 (2.5×2.0×1.0mm max.)
 DEA252450BT-2109C3 (2.5×2.0×1.0mm max.)
 DEA252450BT-2037C1 (2.5×2.0×1.5mm max.)

Issue date: December 2011

- All specifications are subject to change without notice.
 - Conformity to RoHS Directive: This means that, in conformity with EU Directive 2002/95/EC, lead, cadmium, mercury, hexavalent chromium, and specific bromine-based flame retardants, PBB and PBDE, have not been used, except for exempted applications.
-

Multilayer Chip Band Pass Filters For Bluetooth & 2.4GHz W-LAN

Conformity to RoHS Directive

DEA Series DEA252450BT-2080B2

SHAPES AND DIMENSIONS

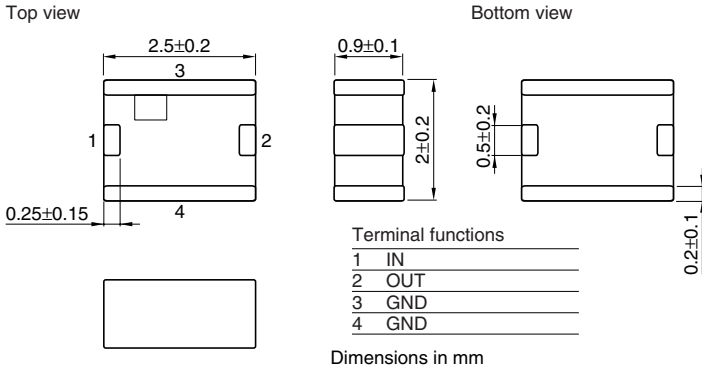

RECOMMENDED PC BOARD PATTERNS

LAND

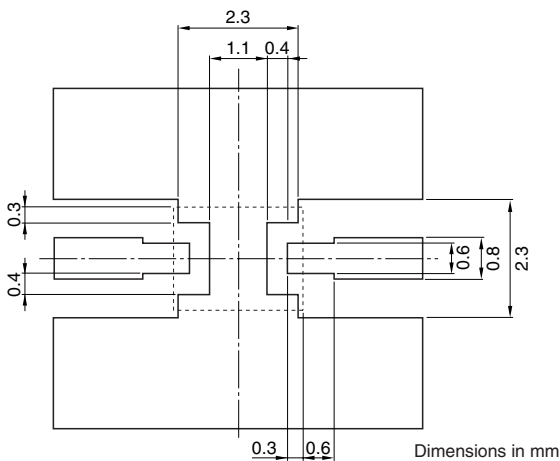

Line width be designed to match 50Ω characteristic impedance depending on PCB material and thickness.

SOLDER RESIST

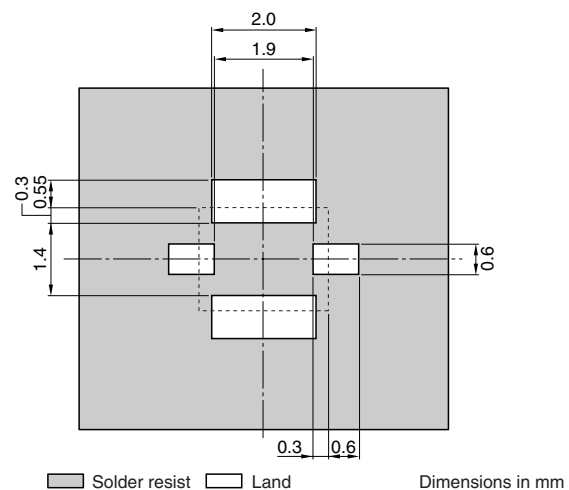

ELECTRICAL CHARACTERISTICS

| Item | | | Minimum value | Typical value | Maximum value |
|----------------|-------------------|-----------|---------------|---------------|---------------|
| Insertion loss | [2400 to 2500MHz] | (dB) | — | 1.56 | 2.0 |
| Return loss | [2400 to 2500MHz] | (dB) | 10.0 | 24.4 | — |
| | [824 to 849MHz] | (dB) | 52.0 | 54.8 | — |
| | [869 to 894MHz] | (dB) | 52.0 | 54.8 | — |
| | [894 to 915MHz] | (dB) | 52.0 | 54.1 | — |
| | [925 to 960MHz] | (dB) | 52.0 | 54.1 | — |
| | [1570 to 1580MHz] | (dB) | 54.0 | 58.2 | — |
| | [1710 to 1785MHz] | (dB) | 54.0 | 68.0 | — |
| | [1805 to 1850MHz] | (dB) | 54.0 | 69.2 | — |
| | [1850 to 1910MHz] | (dB) | 54.0 | 68.4 | — |
| | [1930 to 1990MHz] | (dB) | 48.0 | 51.7 | — |
| Attenuation | [2100MHz] | (dB) | 25.0 | 32.8 | — |
| | [4800 to 5000MHz] | (dB) | 40.0 | 52.1 | — |
| | [7200 to 7500MHz] | (dB) | 21.0 | 32.7 | — |
| | Temperature range | Operating | (°C) | −40 | — |
| | Storage | (°C) | −40 | — | +85 |

• Ta:+25°C

• Conformity to RoHS Directive: This means that, in conformity with EU Directive 2002/95/EC, lead, cadmium, mercury, hexavalent chromium, and specific bromine-based flame retardants, PBB and PBDE, have not been used, except for exempted applications.

• All specifications are subject to change without notice.

FREQUENCY CHARACTERISTICS

INSERTION LOSS

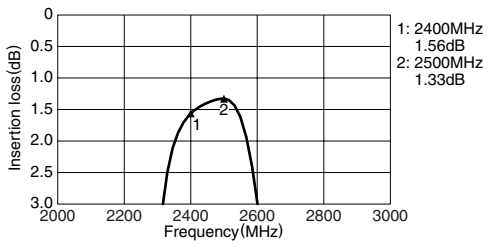

ATTENUATION

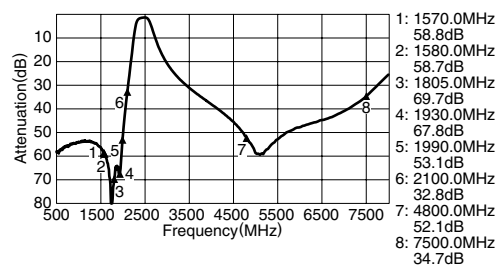

RETURN LOSS

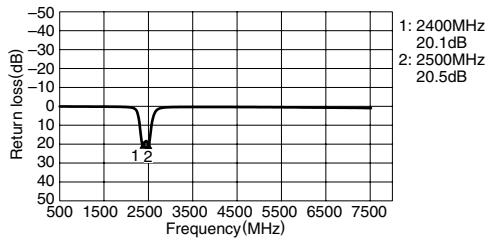

VSWR

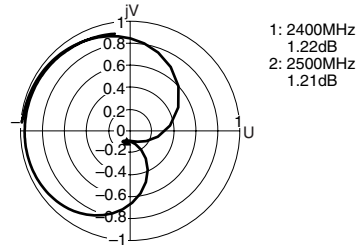

• All specifications are subject to change without notice.

Multilayer Chip Band Pass Filters For Bluetooth & 2.4GHz W-LAN

Conformity to RoHS Directive

DEA Series DEA252450BT-2024C2

SHAPES AND DIMENSIONS

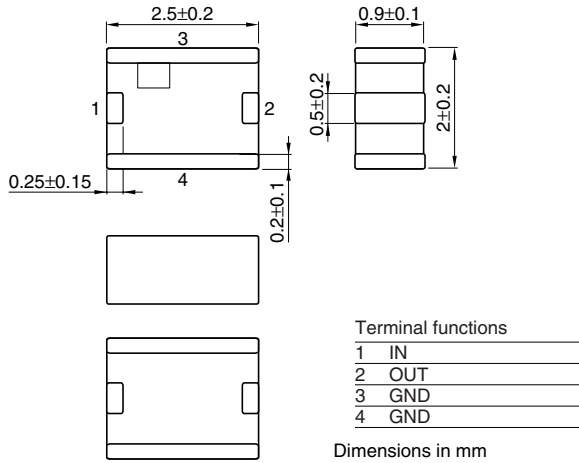

RECOMMENDED PC BOARD PATTERNS

LAND

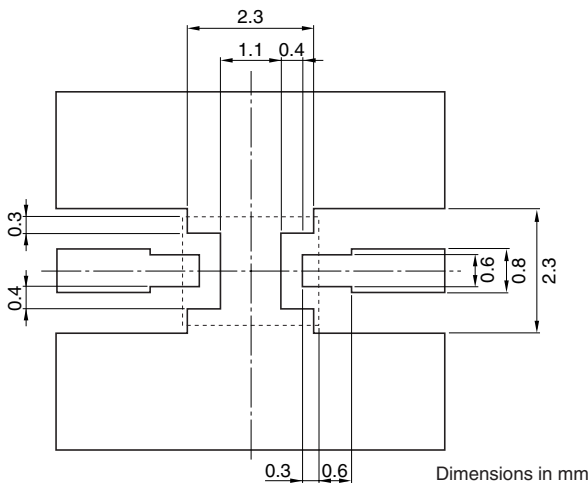

Line width be designed to match 50Ω characteristic impedance depending on PCB material and thickness.

SOLDER RESIST

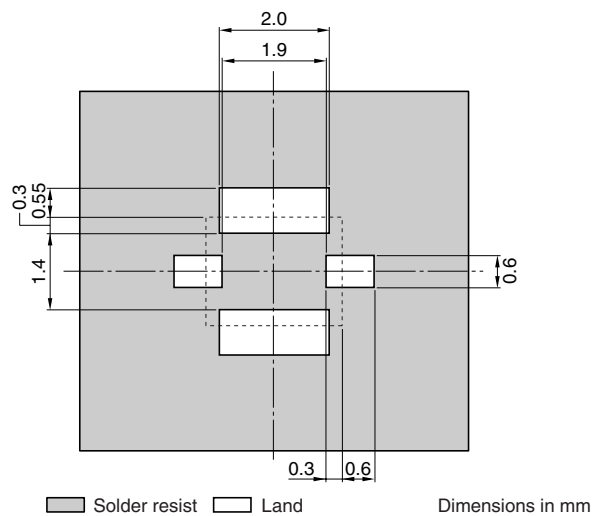

ELECTRICAL CHARACTERISTICS

| Item | | | Minimum value | Typical value | Maximum value |
|-------------------|-------------------|------|---------------|---------------|---------------|
| Insertion loss | [2400 to 2800MHz] | (dB) | — | — | 3.0 |
| Return loss | [2400 to 2800MHz] | (dB) | 10.0 | — | — |
| Attenuation | [880 to 960MHz] | (dB) | 50.0 | — | — |
| | [1565 to 1585MHz] | (dB) | 50.0 | — | — |
| | [1710 to 1880MHz] | (dB) | 48.0 | — | — |
| | [1930 to 1990MHz] | (dB) | 48.0 | — | — |
| | [2110 to 2170MHz] | (dB) | 22.0 | — | — |
| Temperature range | Operating | (°C) | -40 | — | +85 |
| | Storage | (°C) | -40 | — | +85 |

• Ta: +25°C

• Conformity to RoHS Directive: This means that, in conformity with EU Directive 2002/95/EC, lead, cadmium, mercury, hexavalent chromium, and specific bromine-based flame retardants, PBB and PBDE, have not been used, except for exempted applications.

• All specifications are subject to change without notice.

FREQUENCY CHARACTERISTICS

INSERTION LOSS

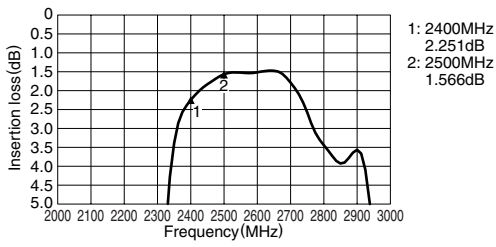

ATTENUATION

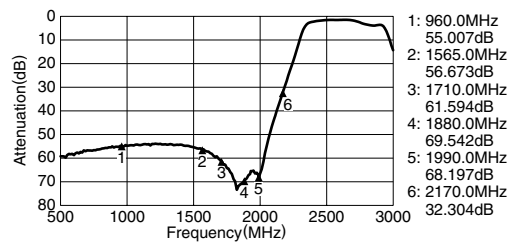

RETURN LOSS

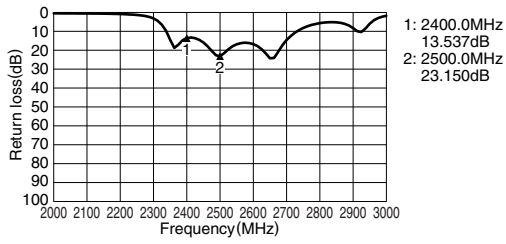

VSWR

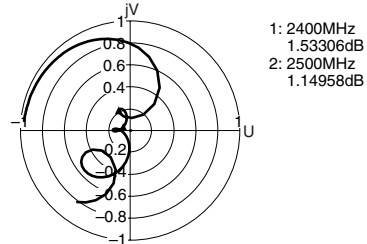

Multilayer Chip Band Pass Filters For Bluetooth & 2.4GHz W-LAN

Conformity to RoHS Directive

DEA Series DEA252450BT-2024C5

SHAPES AND DIMENSIONS

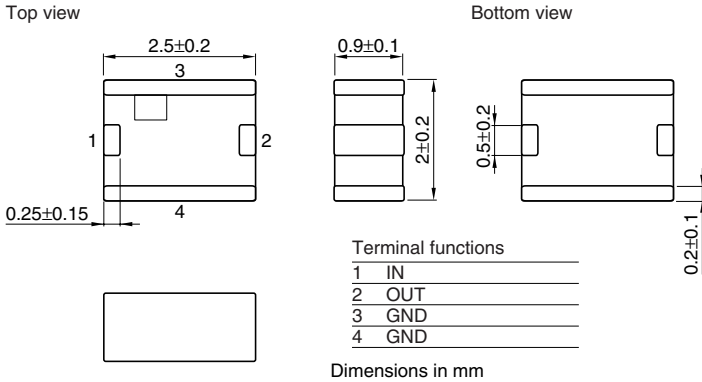

RECOMMENDED PC BOARD PATTERNS

LAND

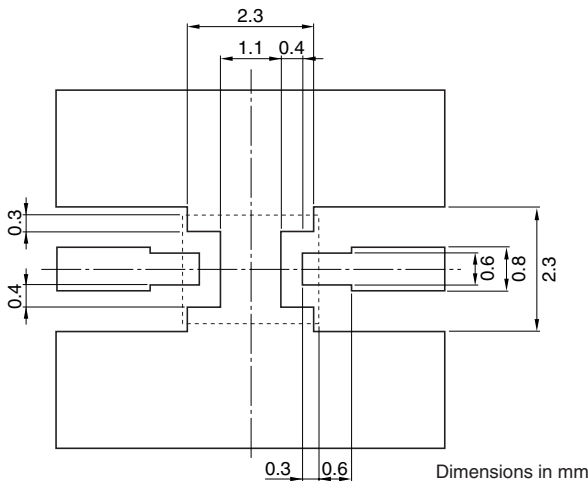

Line width be designed to match 50Ω characteristic impedance depending on PCB material and thickness.

SOLDER RESIST

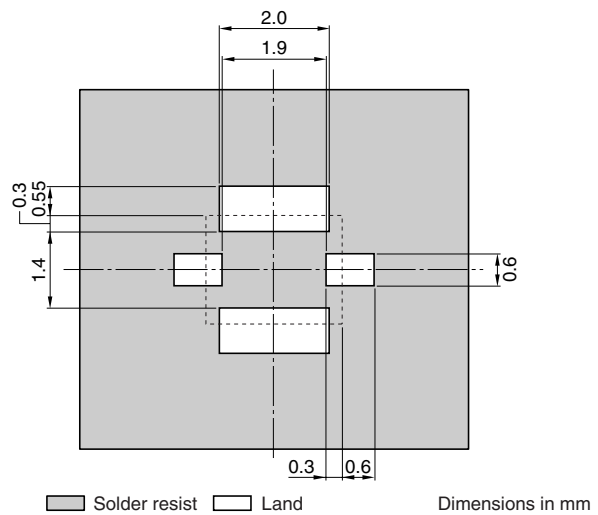

ELECTRICAL CHARACTERISTICS

| Item | | | Minimum value | Typical value | Maximum value |
|-------------------|-------------------|------|---------------|---------------|---------------|
| Center frequency | [2450MHz] | | — | — | |
| Insertion loss | [2400 to 2500MHz] | (dB) | — | — | 2.1 |
| Return loss | [2400 to 2500MHz] | (dB) | 10.0 | — | — |
| Attenuation | [880 to 915MHz] | (dB) | 45.0 | — | — |
| | [1710 to 1990MHz] | (dB) | 48.0 | — | — |
| | [2110 to 2170MHz] | (dB) | 20.0 | — | — |
| | [3000MHz] | (dB) | 14.0 | — | — |
| | [4800 to 5000MHz] | (dB) | 30.0 | — | — |
| Temperature range | Operating | (°C) | -40 | — | +85 |
| | Storage | (°C) | -40 | — | +85 |

• Ta: +25°C

• Conformity to RoHS Directive: This means that, in conformity with EU Directive 2002/95/EC, lead, cadmium, mercury, hexavalent chromium, and specific bromine-based flame retardants, PBB and PBDE, have not been used, except for exempted applications.

• All specifications are subject to change without notice.

FREQUENCY CHARACTERISTICS

INSERTION LOSS

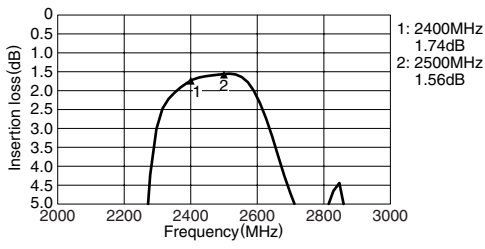

ATTENUATION

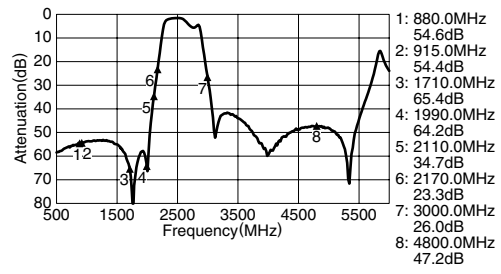

RETURN LOSS

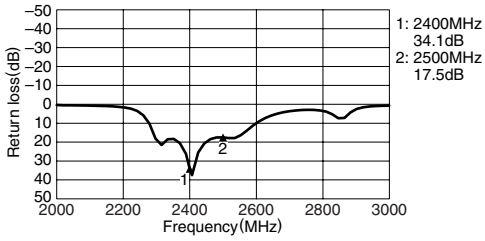

VSWR

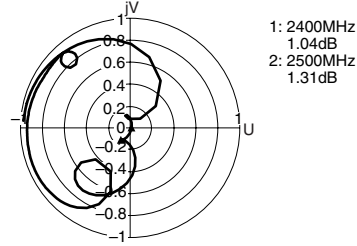

Multilayer Chip Band Pass Filters For Bluetooth & 2.4GHz W-LAN

Conformity to RoHS Directive

DEA Series DEA252400BT-2030A1

SHAPES AND DIMENSIONS

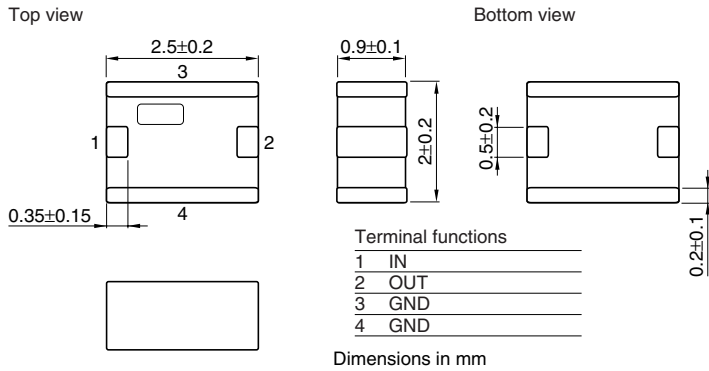

RECOMMENDED PC BOARD PATTERNS

LAND

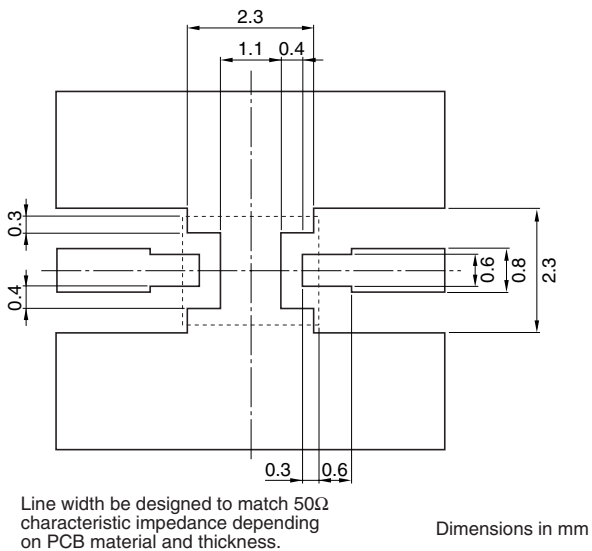

SOLDER RESIST

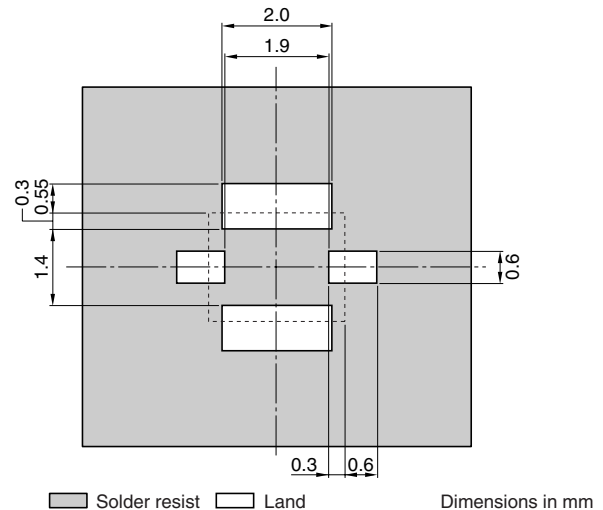

ELECTRICAL CHARACTERISTICS

| Item | | | Minimum value | Typical value | Maximum value |
|-------------------|-------------------|------|---------------|---------------|---------------|
| Insertion loss | [2300 to 2500MHz] | (dB) | — | — | 1.4 |
| Return loss | [2300 to 2500MHz] | (dB) | 10 | — | — |
| Attenuation | [880 to 915MHz] | (dB) | 35 | — | — |
| | [1710 to 1785MHz] | (dB) | 35 | — | — |
| | [1850 to 1910MHz] | (dB) | 35 | — | — |
| Temperature range | Operating | (°C) | -40 | — | +85 |
| | Storage | (°C) | -40 | — | +85 |

• Ta: +25°C

• Conformity to RoHS Directive: This means that, in conformity with EU Directive 2002/95/EC, lead, cadmium, mercury, hexavalent chromium, and specific bromine-based flame retardants, PBB and PBDE, have not been used, except for exempted applications.

• All specifications are subject to change without notice.

FREQUENCY CHARACTERISTICS

INSERTION LOSS

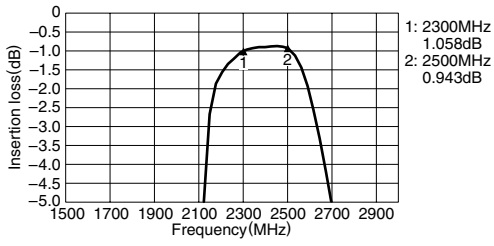

ATTENUATION

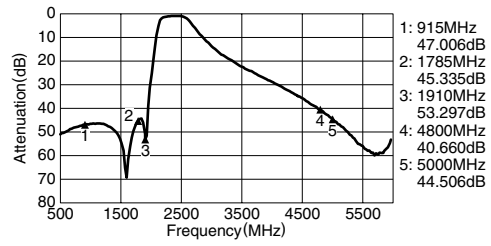

RETURN LOSS

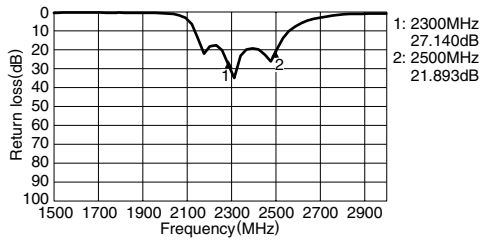

VSWR

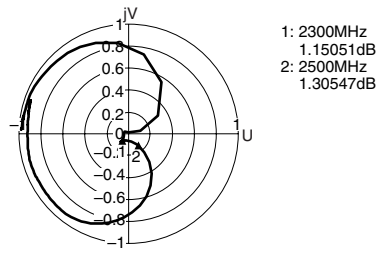

• All specifications are subject to change without notice.

Multilayer Chip Band Pass Filters For Bluetooth & 2.4GHz W-LAN

Conformity to RoHS Directive

DEA Series DEA252450BT-2024D4

SHAPES AND DIMENSIONS

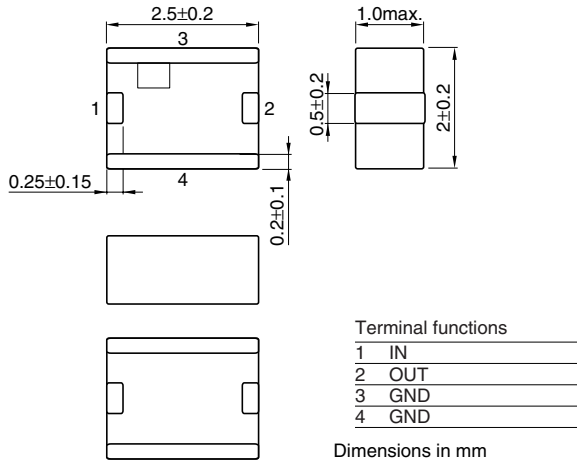

RECOMMENDED PC BOARD PATTERNS

LAND

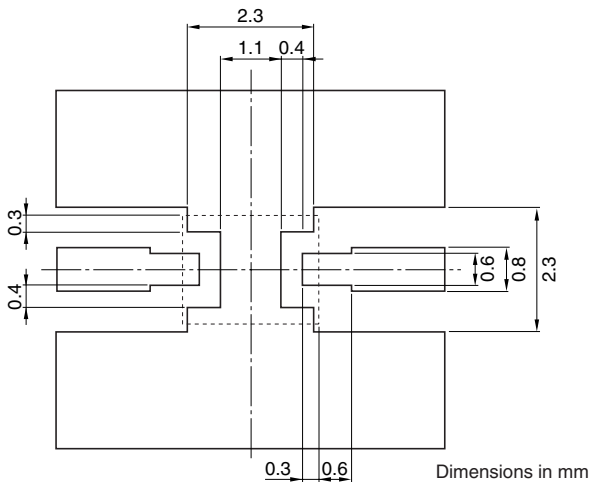

Line width be designed to match 50Ω characteristic impedance depending on PCB material and thickness.

SOLDER RESIST

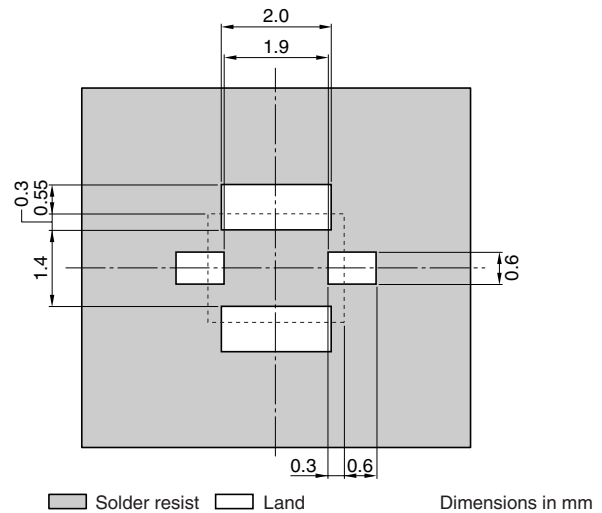

ELECTRICAL CHARACTERISTICS

| Item | | | Minimum value | Typical value | Maximum value |
|-------------------|-------------------|------|---------------|---------------|---------------|
| Insertion loss | [2400 to 2500MHz] | (dB) | — | 2.23 | 3.0 |
| Return loss | [2400 to 2500MHz] | (dB) | 10.0 | 18.2 | — |
| Attenuation | [880 to 960MHz] | (dB) | 50.0 | 52.6 | — |
| | [1565 to 1585MHz] | (dB) | 50.0 | 55.2 | — |
| | [1710 to 1880MHz] | (dB) | 40.0 | 49.4 | — |
| | [1930 to 1990MHz] | (dB) | 40.0 | 42.9 | — |
| | [2110 to 2170MHz] | (dB) | 33.0 | 42.8 | — |
| Temperature range | Operating | (°C) | −40 | — | +85 |
| | Storage | (°C) | −40 | — | +85 |

• Ta: +25°C

• Conformity to RoHS Directive: This means that, in conformity with EU Directive 2002/95/EC, lead, cadmium, mercury, hexavalent chromium, and specific bromine-based flame retardants, PBB and PBDE, have not been used, except for exempted applications.

• All specifications are subject to change without notice.

FREQUENCY CHARACTERISTICS

INSERTION LOSS

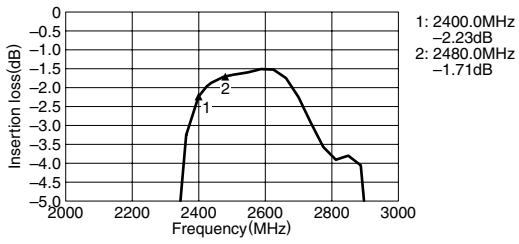

ATTENUATION

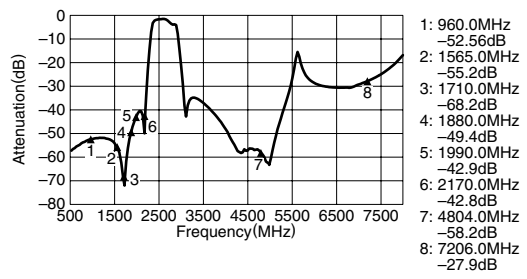

RETURN LOSS

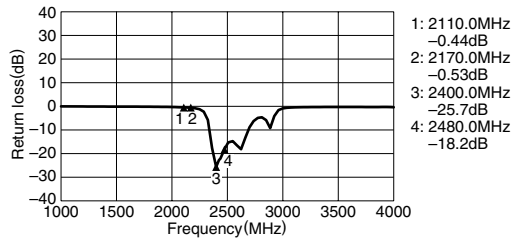

VSWR

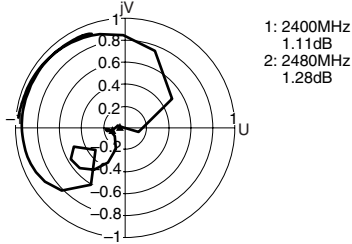

• All specifications are subject to change without notice.

Multilayer Chip Band Pass Filters For Bluetooth & 2.4GHz W-LAN

Conformity to RoHS Directive

DEA Series DEA252450BT-2027A1

SHAPES AND DIMENSIONS

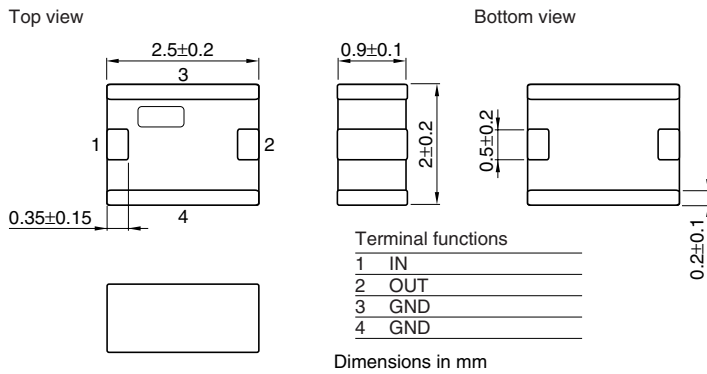

RECOMMENDED PC BOARD PATTERNS

LAND

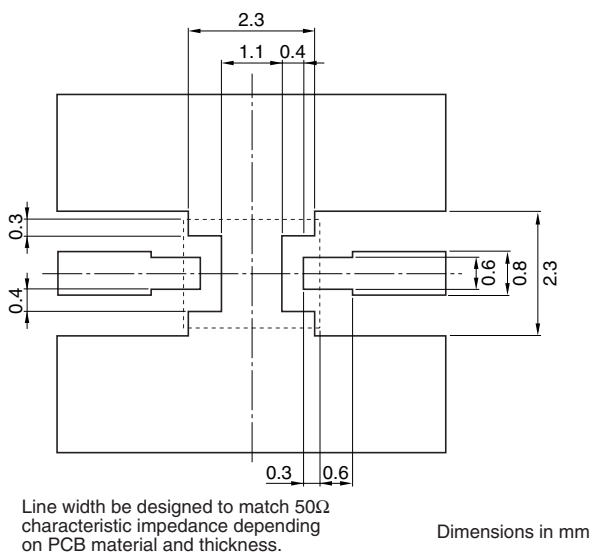

SOLDER RESIST

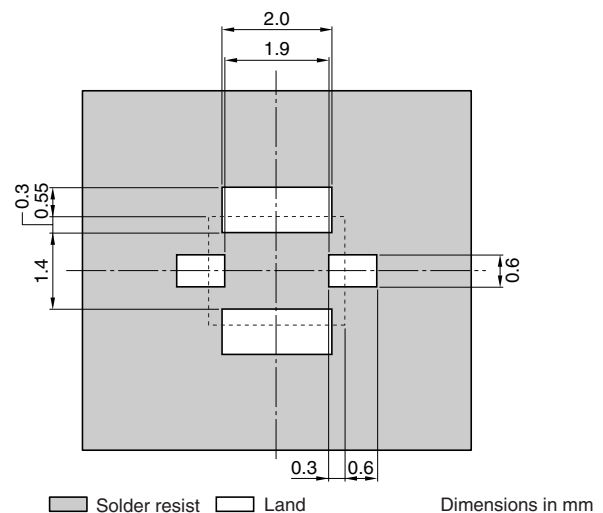

ELECTRICAL CHARACTERISTICS

| Item | | | Minimum value | Typical value | Maximum value |
|-------------------|-------------------|------|---------------|---------------|---------------|
| Insertion loss | [2400 to 2500MHz] | (dB) | — | — | 1.2 |
| Return loss | [2400 to 2500MHz] | (dB) | 10 | — | — |
| Attenuation | [880 to 915MHz] | (dB) | 35 | — | — |
| | [1710 to 1785MHz] | (dB) | 35 | — | — |
| | [1850 to 1910MHz] | (dB) | 35 | — | — |
| | [4800 to 5000MHz] | (dB) | 30 | — | — |
| Temperature range | Operating | (°C) | −40 | — | +85 |
| | Storage | (°C) | −40 | — | +85 |

• Ta: +25°C

• Conformity to RoHS Directive: This means that, in conformity with EU Directive 2002/95/EC, lead, cadmium, mercury, hexavalent chromium, and specific bromine-based flame retardants, PBB and PBDE, have not been used, except for exempted applications.

• All specifications are subject to change without notice.

FREQUENCY CHARACTERISTICS

INSERTION LOSS

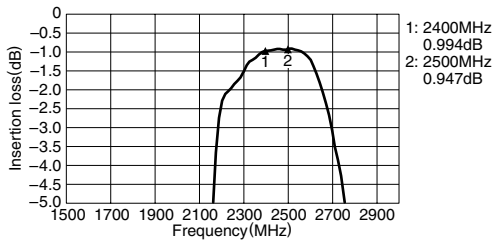

ATTENUATION

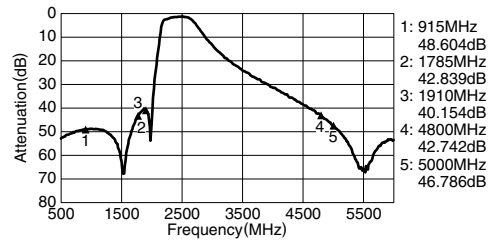

RETURN LOSS

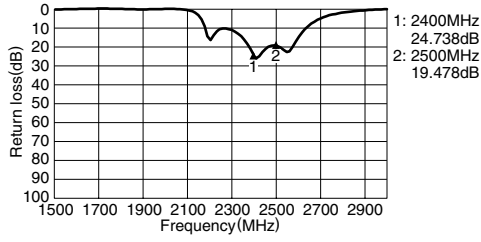

VSWR

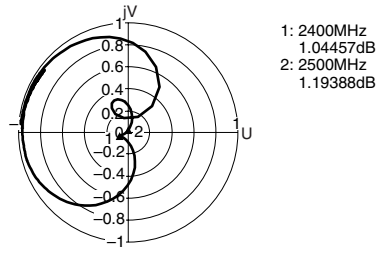

• All specifications are subject to change without notice.

Multilayer Chip Band Pass Filters For Bluetooth & 2.4GHz W-LAN

Conformity to RoHS Directive

DEA Series DEA252450BT-2031A1

SHAPES AND DIMENSIONS

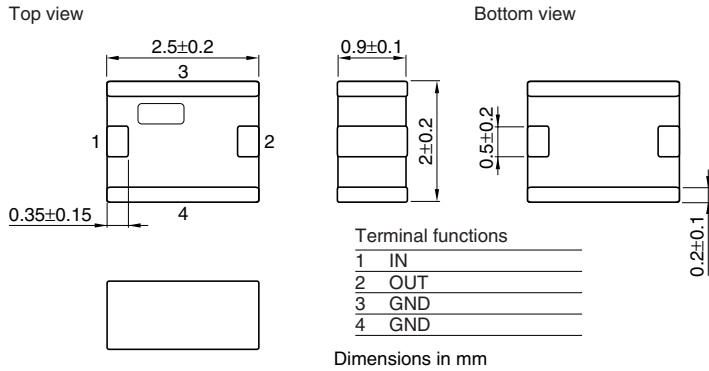

RECOMMENDED PC BOARD PATTERNS

LAND

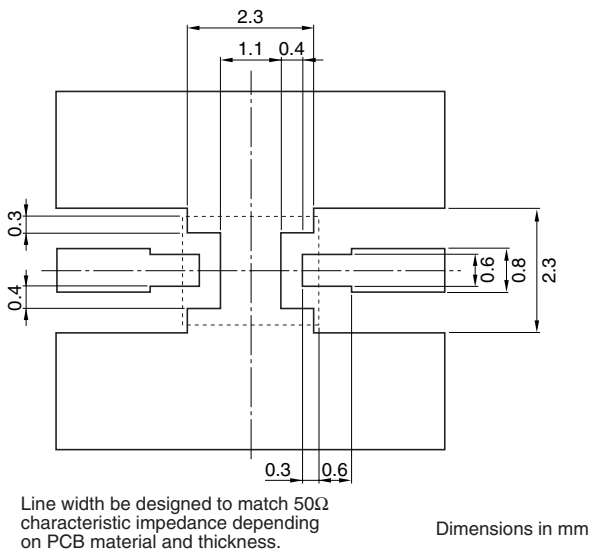

SOLDER RESIST

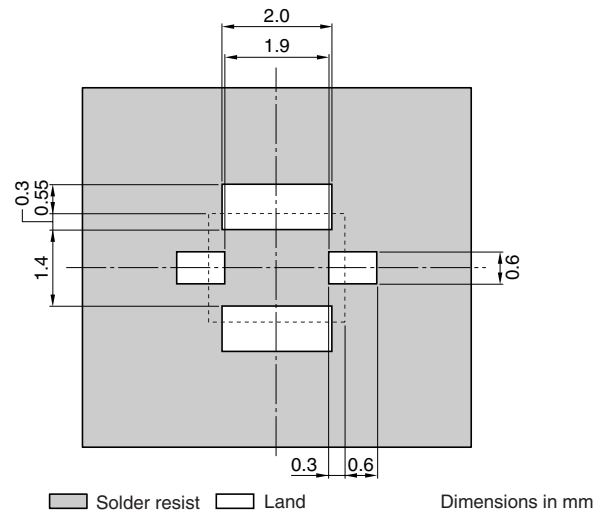

ELECTRICAL CHARACTERISTICS

| Item | | | Minimum value | Typical value | Maximum value |
|-------------------|-------------------|------|---------------|---------------|---------------|
| Insertion loss | [2400 to 2500MHz] | (dB) | — | — | 1.5 |
| Return loss | [2400 to 2500MHz] | (dB) | 10 | — | — |
| Attenuation | [915MHz] | (dB) | 35 | — | — |
| | [1750MHz] | (dB) | 30 | — | — |
| | [2100MHz] | (dB) | 20 | — | — |
| | [4800 to 5000MHz] | (dB) | 23 | — | — |
| Temperature range | Operating | (°C) | −40 | — | +85 |
| | Storage | (°C) | −40 | — | +85 |

• Ta: +25°C

• Conformity to RoHS Directive: This means that, in conformity with EU Directive 2002/95/EC, lead, cadmium, mercury, hexavalent chromium, and specific bromine-based flame retardants, PBB and PBDE, have not been used, except for exempted applications.

• All specifications are subject to change without notice.

FREQUENCY CHARACTERISTICS

INSERTION LOSS

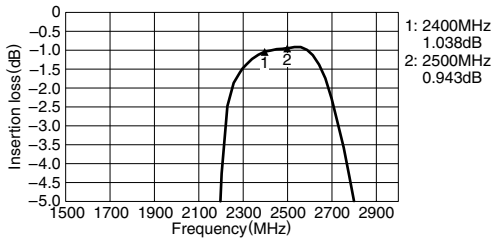

ATTENUATION

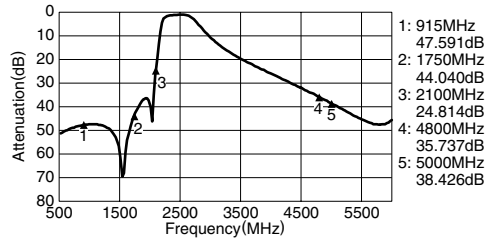

RETURN LOSS

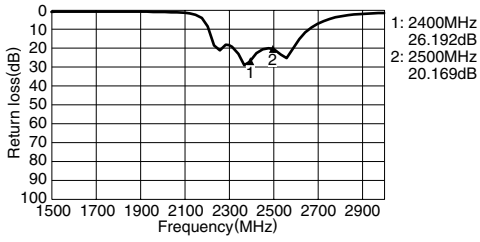

VSWR

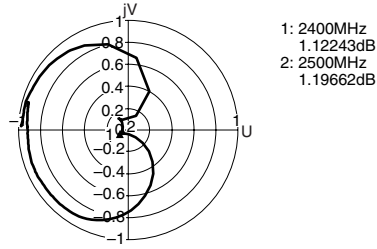

Multilayer Chip Band Pass Filters For Bluetooth & 2.4GHz W-LAN

Conformity to RoHS Directive

DEA Series DEA252450BT-2063C1

SHAPES AND DIMENSIONS

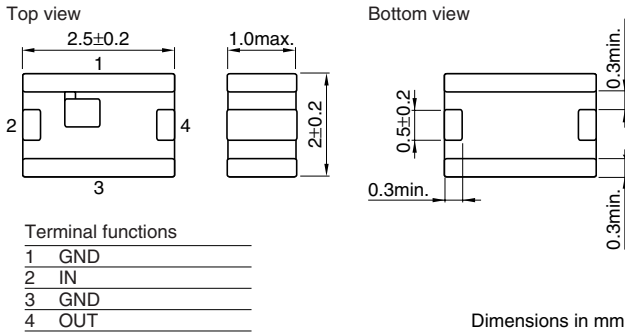

RECOMMENDED PC BOARD PATTERNS

LAND

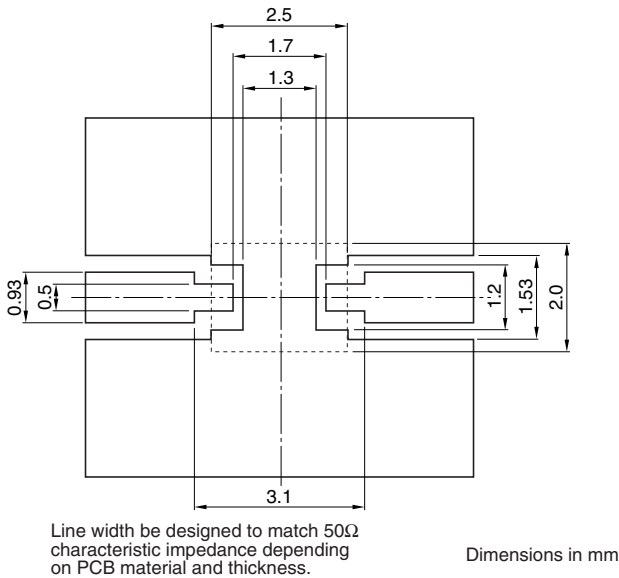

SOLDER RESIST

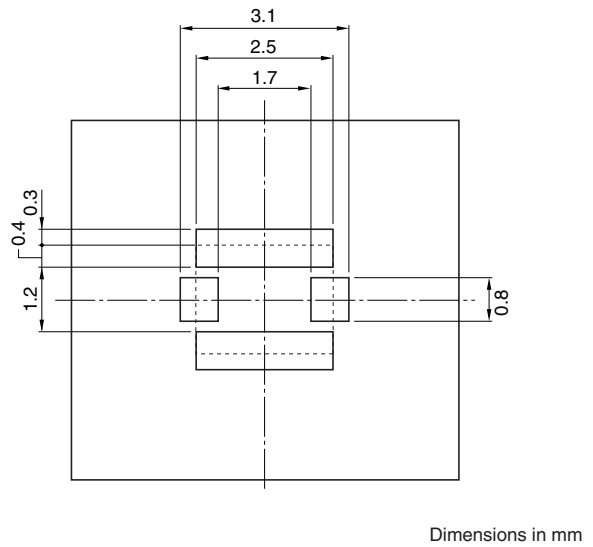

- Conformity to RoHS Directive: This means that, in conformity with EU Directive 2002/95/EC, lead, cadmium, mercury, hexavalent chromium, and specific bromine-based flame retardants, PBB and PBDE, have not been used, except for exempted applications.

- All specifications are subject to change without notice.

ELECTRICAL CHARACTERISTICS

| | | |
|--|-------------------|-----------------|
| Frequency range(Pass band) | | 2400 to 2500MHz |
| Insertion loss | [+25°C] | 2.5dB max. |
| | [-40 to +85°C] | 2.8dB max. |
| Single ended port characteristic impedance | | 50Ω (Nominal) |
| Return loss | [2400 to 2500MHz] | 10dB min. |
| Ripple | [2400 to 2500MHz] | 1.0dB max. |
| | [824 to 829MHz] | 47dB min. |
| | [880 to 915MHz] | 47dB min. |
| | [1525 to 1559MHz] | 42dB min. |
| | [1710 to 1785MHz] | 47dB min. |
| | [1850 to 1910MHz] | 47dB min. |
| | [2110 to 2170MHz] | 35dB min. |
| Temperature range | Operating | -40 to +85°C |
| | Storage | -40 to +85°C |

• Ta:+25°C

FREQUENCY CHARACTERISTICS

ATTENUATION

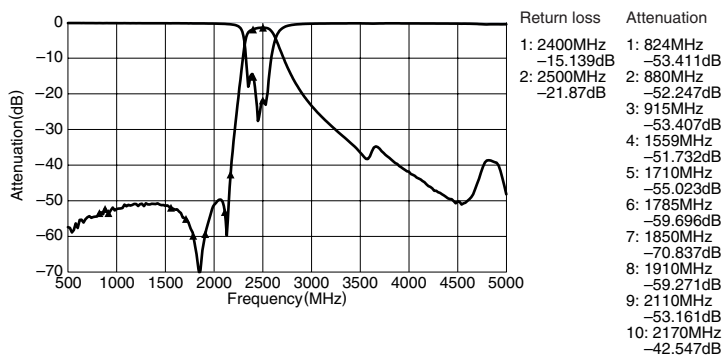

INSERTION LOSS

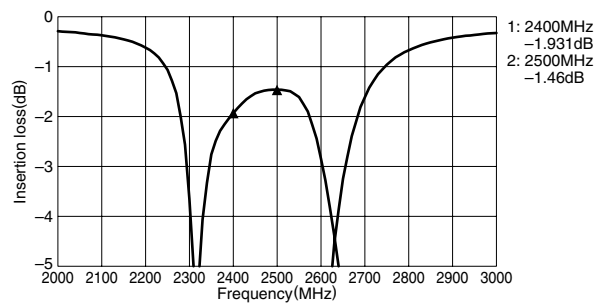

• All specifications are subject to change without notice.

Multilayer Chip Band Pass Filters For Bluetooth & 2.4GHz W-LAN

Conformity to RoHS Directive

DEA Series DEA252450BT-2109C3

SHAPES AND DIMENSIONS

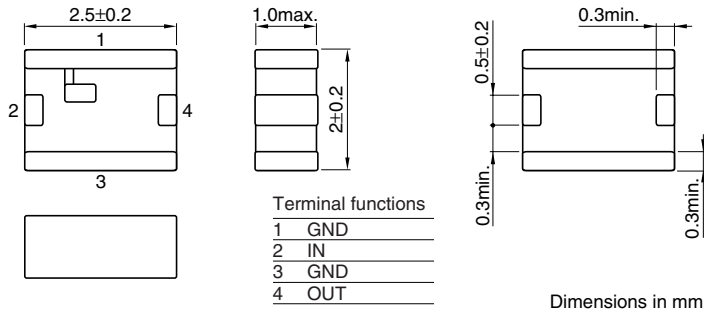

RECOMMENDED PC BOARD PATTERNS

LAND

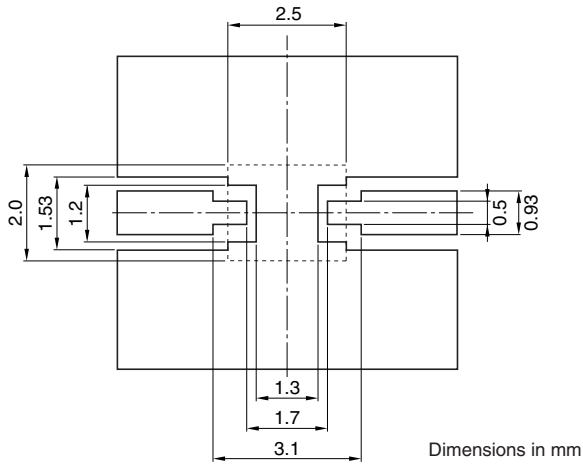

SOLDER RESIST

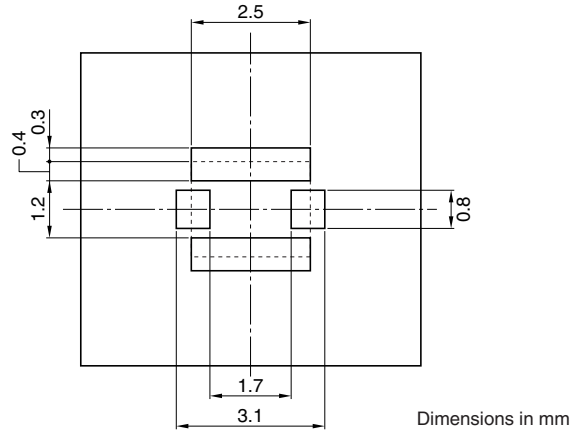

Line width be designed to match 50Ω characteristic impedance, depending on PCB material and thickness.

• Conformity to RoHS Directive: This means that, in conformity with EU Directive 2002/95/EC, lead, cadmium, mercury, hexavalent chromium, and specific bromine-based flame retardants, PBB and PBDE, have not been used, except for exempted applications.

• All specifications are subject to change without notice.

ELECTRICAL CHARACTERISTICS

| Item | | Minimum value | Typical value | Maximum value | |
|-------------------------------------|-------------------|---------------|---------------|---------------|---|
| Frequency range(Pass band) | (MHz) | 2400 | — | 2500 | |
| Characteristic impedance(Pass band) | (Ω) | — | 50[Nominal] | — | |
| Insertion loss(Pass band) | [+25°C] | — | — | 2.3 | |
| | [-40 to +85°C] | — | — | 2.5 | |
| Return loss(Pass band) | (dB) | 10 | — | — | |
| | [DC to 76MHz] | (dB) | 45 | — | — |
| | [76 to 108MHz] | (dB) | 45 | — | — |
| | [480MHz] | (dB) | 45 | — | — |
| | [746 to 764MHz] | (dB) | 45 | — | — |
| | [776 to 794MHz] | (dB) | 45 | — | — |
| | [824 to 849MHz] | (dB) | 45 | — | — |
| | [869 to 880MHz] | (dB) | 45 | — | — |
| | [880 to 915MHz] | (dB) | 45 | — | — |
| | [925 to 960MHz] | (dB) | 45 | — | — |
| | [1570 to 1580MHz] | (dB) | 43 | — | — |
| | [1710 to 1785MHz] | (dB) | 44 | — | — |
| | [1805 to 1850MHz] | (dB) | 40 | — | — |
| | [1850 to 1910MHz] | (dB) | 40 | — | — |
| | [1920 to 1980MHz] | (dB) | 38 | — | — |
| | [1980 to 1990MHz] | (dB) | 38 | — | — |
| | [2110 to 2170MHz] | (dB) | 30 | — | — |
| [2750 to 3000MHz] | (dB) | 5 | — | — | |
| [3000 to 4800MHz] | (dB) | 15 | — | — | |
| [4800 to 5000MHz] | (dB) | 30 | — | — | |
| [5150 to 5850MHz] | (dB) | 30 | — | — | |
| [7200 to 7500MHz] | (dB) | 20 | — | — | |
| Temperature range | Operating | (°C) | -40 | +85 | |
| | Storage | (°C) | -40 | +85 | |

• Ta:+25°C

FREQUENCY CHARACTERISTICS

INSERTION LOSS

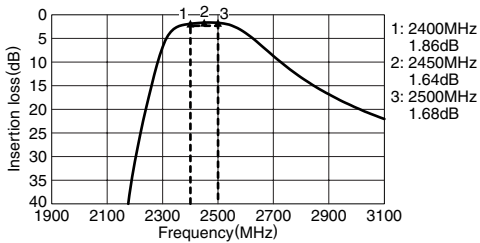

ATTENUATION

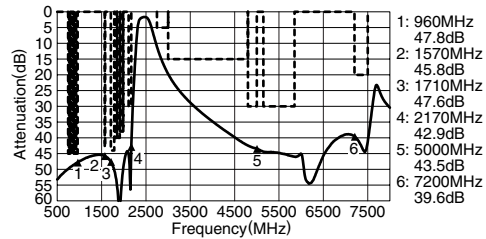

RETURN LOSS

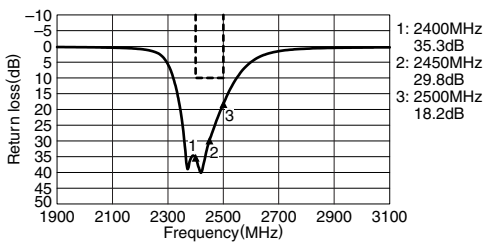

VSWR

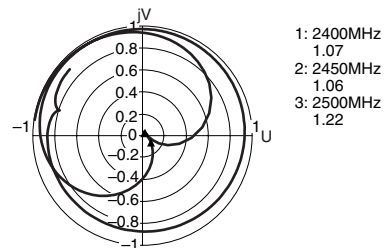

• All specifications are subject to change without notice.

Multilayer Chip Band Pass Filters For Bluetooth & 2.4GHz W-LAN

Conformity to RoHS Directive

DEA Series DEA252450BT-2037C1

SHAPES AND DIMENSIONS

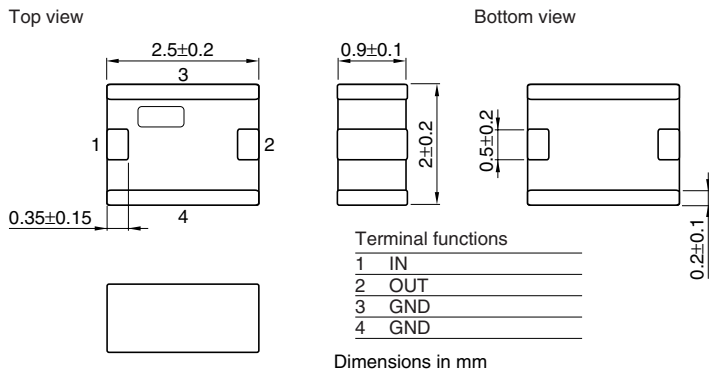

RECOMMENDED PC BOARD PATTERNS

LAND

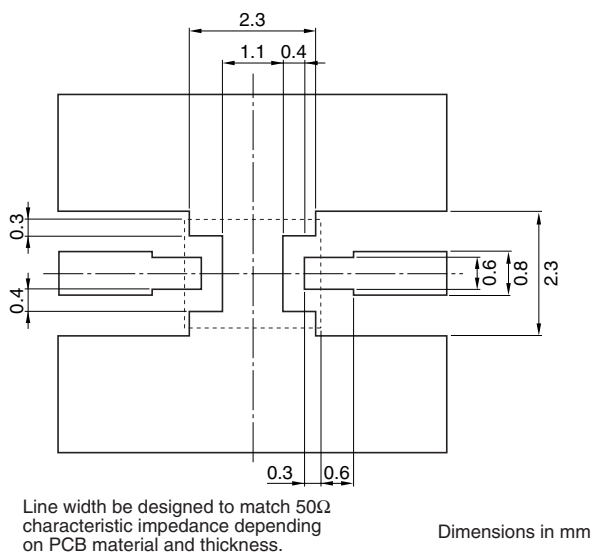

SOLDER RESIST

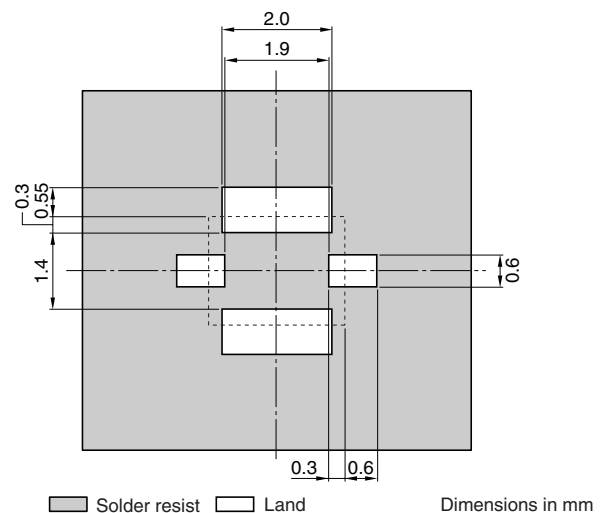

ELECTRICAL CHARACTERISTICS

| Item | | Minimum value | Typical value | Maximum value |
|-------------------|-------------------|---------------|---------------|---------------|
| Center frequency | [2450MHz] | | | |
| Insertion loss | [2400 to 2500MHz] | (dB) — | — | 3 |
| Return loss | [2400 to 2500MHz] | (dB) 10 | — | — |
| Attenuation | [880 to 915MHz] | (dB) 43 | — | — |
| | [1710 to 1990MHz] | (dB) 24 | — | — |
| | [2110 to 2170MHz] | (dB) 14 | — | — |
| | [2700MHz] | (dB) 25 | — | — |
| Temperature range | Operating | (°C) -40 | — | +85 |
| | Storage | (°C) -40 | — | +85 |

• Ta: +25°C

• Conformity to RoHS Directive: This means that, in conformity with EU Directive 2002/95/EC, lead, cadmium, mercury, hexavalent chromium, and specific bromine-based flame retardants, PBB and PBDE, have not been used, except for exempted applications.

• All specifications are subject to change without notice.

FREQUENCY CHARACTERISTICS

INSERTION LOSS

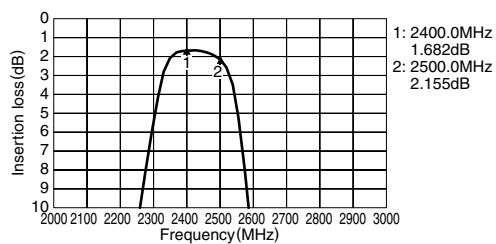

ATTENUATION

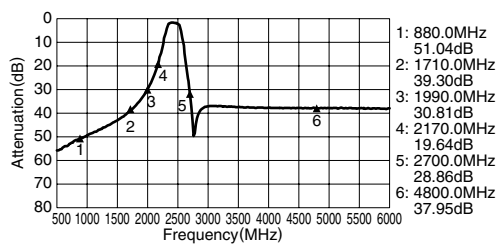

RETURN LOSS

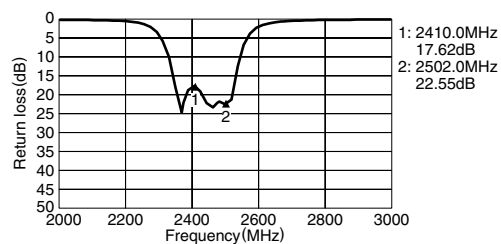

VSWR

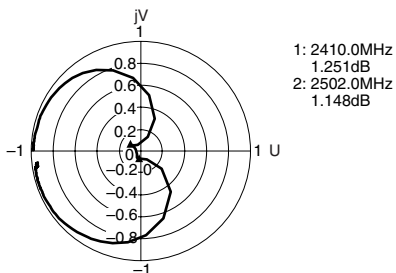

• All specifications are subject to change without notice.