

Multilayer Chip Directional Couplers For DCS/Tx

Conformity to RoHS Directive

HHM Series HHM2204SA1

SHAPES AND DIMENSIONS

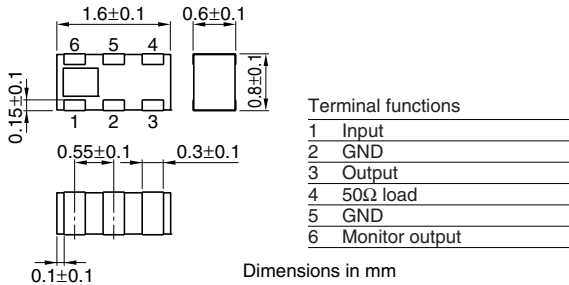

CIRCUIT DIAGRAM

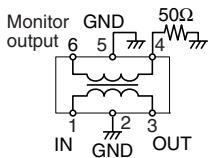

RECOMMENDED PC BOARD PATTERNS

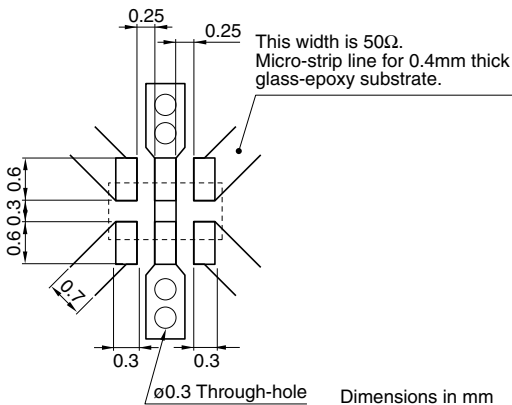

ELECTRICAL CHARACTERISTICS

Frequency range	1710 to 1785MHz
Coupling factor	15.0±1.0dB
Insertion loss	0.30dB max.*1 0.35dB max.*2
Isolation	25dB min.
VSWR	1.3 max.
Temperature range	Operating -40 to +85°C Storage -40 to +85°C

*1 25°C

*2 Operating temperature

• Conformity to RoHS Directive: This means that, in conformity with EU Directive 2002/95/EC, lead, cadmium, mercury, hexavalent chromium, and specific bromine-based flame retardants, PBB and PBDE, have not been used, except for exempted applications.

• All specifications are subject to change without notice.

FREQUENCY CHARACTERISTICS

COUPLING

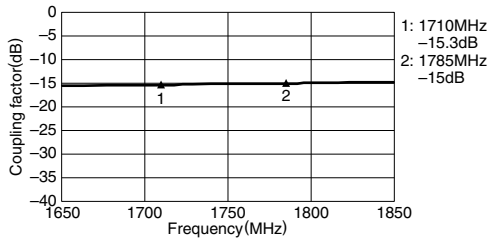

ISOLATION

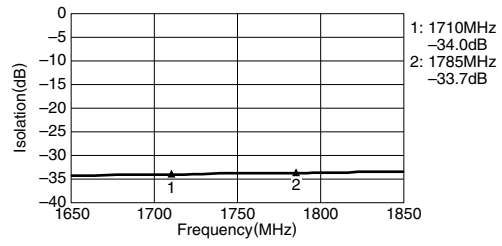

INSERTION LOSS

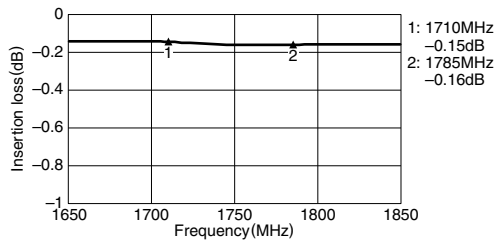

VSWR

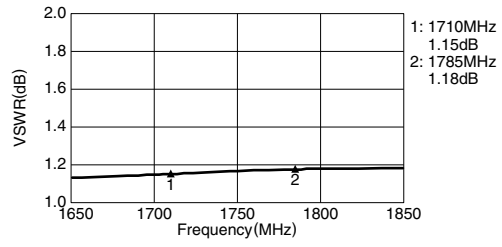

• All specifications are subject to change without notice.