



Balun Transformers

Wound SMD

ATB series

ATB2012-50011 (2.0×1.2×1.2mm)

ATB2012-75011 (2.0×1.2×1.2mm)

ATB2012E-50011M (2.0×1.2×1.0mm)

ATB2012E-75011M (2.0×1.2×1.0mm)

REMINDERS FOR USING THESE PRODUCTS

Before using these products, be sure to request the delivery specifications.

SAFETY REMINDERS

Please pay sufficient attention to the warnings for safe designing when using these products.

REMINDERS

- The storage period is less than 6 months. Be sure to follow the storage conditions (Temperature: 5 to 40°C, Humidity: 10 to 75% RH or less).
If the storage period elapses, the soldering of the terminal electrodes may deteriorate.
- Do not use or store in locations where there are conditions such as gas corrosion (salt, acid, alkali, etc.).
- Before soldering, be sure to preheat components.
The preheating temperature should be set so that the temperature difference between the solder temperature and chip temperature does not exceed 150°C.
- Soldering corrections after mounting should be within the range of the conditions determined in the specifications.
If overheated, a short circuit, performance deterioration, or lifespan shortening may occur.
- When embedding a printed circuit board where a chip is mounted to a set, be sure that residual stress is not given to the chip due to the overall distortion of the printed circuit board and partial distortion such as at screw tightening portions.
- Self heating (temperature increase) occurs when the power is turned ON, so the tolerance should be sufficient for the set thermal design.
- Carefully lay out the coil for the circuit board design of the non-magnetic shield type.
A malfunction may occur due to magnetic interference.
- Use a wrist band to discharge static electricity in your body through the grounding wire.
- Do not expose the products to magnets or magnetic fields.
- Do not use for a purpose outside of the contents regulated in the delivery specifications.
- The products listed on this catalog are intended for use in general electronic equipment (AV equipment, telecommunications equipment, home appliances, amusement equipment, computer equipment, personal equipment, office equipment, measurement equipment, industrial robots) under a normal operation and use condition.
The products are not designed or warranted to meet the requirements of the applications listed below, whose performance and/or quality require a more stringent level of safety or reliability, or whose failure, malfunction or trouble could cause serious damage to society, person or property.
If you intend to use the products in the applications listed below or if you have special requirements exceeding the range or conditions set forth in the each catalog, please contact us.

- (1) Aerospace/Aviation equipment
- (2) Transportation equipment (cars, electric trains, ships, etc.)
- (3) Medical equipment
- (4) Power-generation control equipment
- (5) Atomic energy-related equipment
- (6) Seabed equipment
- (7) Transportation control equipment

- (8) Public information-processing equipment
- (9) Military equipment
- (10) Electric heating apparatus, burning equipment
- (11) Disaster prevention/crime prevention equipment
- (12) Safety equipment
- (13) Other applications that are not considered general-purpose applications

When designing your equipment even for general-purpose applications, you are kindly requested to take into consideration securing protection circuit/device or providing backup circuits in your equipment.

Balun Transformers

Wound SMD

Product compatible with RoHS directive

Halogen-free

Compatible with lead-free solders

Overview of the ATB Series

FEATURES

- Chip balun transformer developed for impedance systems; ATB2012-50011 and ATB2012E-50011M are for 50Ω impedance and ATB2012-75011 and ATB2012E-75011M are for 75Ω impedance.
- Input impedance is 50Ω for ATB2012-50011 and ATB2012E-50011M, and 75Ω for ATB2012-75011 and ATB2012E-75011M.
- The impedance ratio is 1:1.
- The frequency band width for ATB2012-50011 is 40MHz to 860MHz (Standard IL = 1.0dB), for ATB2012E-50011M is 400MHz to 1.8GHz (Standard IL = 1.0dB), for ATB2012-75011 is 50MHz to 1.2GHz (Standard IL = 0.8dB), and for ATB2012E-75011M is 400MHz to 1.8GHz (Standard IL = 1.0dB).

APPLICATION

- TV and mobile device tuners (DVB-T/H, ISDB-T, etc.)
- STB / tuner power divider

PART NUMBER CONSTRUCTION

ATB		2012		-		500		11		-		T		□□□	
Series name	L×W×H Dimensions (mm)		Input impedance (Ω)		Impedance ratio		Packaging style		Internal code						
	2012	2.0×1.2×1.2		500	50	11	1:1	T	ø180mm reel						
			750	75			TL	ø330mm reel							

ATB		2012E		-		500		11		-		M		-		T		□□	
Series name	L×W×H Dimensions (mm)		Input impedance (Ω)		Impedance ratio		Product internal code		Packaging style		Internal code								
	2012	2.0×1.2×1.0		500	50	11	1:1	M		T	ø180mm reel								
			750	75					TL	ø330mm reel									

OPERATING TEMPERATURE RANGE, PACKAGE QUANTITY, PRODUCT WEIGHT

Type	Temperature range		Reel diameter	Package quantity	Individual weight
	Operating temperature*	Storage temperature**			
	(°C)	(°C)			
ATB2012-50011	-40 to +85	-40 to +85	ø180mm	2,000	10
			ø330mm	10,000	
ATB2012-75011	-40 to +85	-40 to +85	ø180mm	2,000	10
			ø330mm	10,000	
ATB2012E-50011M	-40 to +85	-40 to +85	ø180mm	2,000	10
			ø330mm	10,000	
ATB2012E-75011M	-40 to +85	-40 to +85	ø180mm	2,000	10
			ø330mm	10,000	

* Operating temperature range includes self-temperature rise.

** The Storage temperature range is for after the circuit board is mounted.

- RoHS Directive Compliant Product: See the following for more details related to RoHS Directive compliant products. <http://www.tdk.co.jp/rohs/>
- Halogen-free: Indicates that Cl content is less than 900ppm, Br content is less than 900ppm, and that the total Cl and Br content is less than 1500ppm.

• All specifications are subject to change without notice.

Overview of the ATB Series

RECOMMENDED REFLOW PROFILE



Preheating			Soldering		Peak	
Temp.	Temp.	Time	Temp.	Time	Temp.	Time
T1	T2	t1	T3	t2	T4	t3
150°C	180°C	60 to 120s	230°C	10 to 30s	245°C	5s max.

ATB series

ATB2012-50011 Type



SHAPE & DIMENSIONS

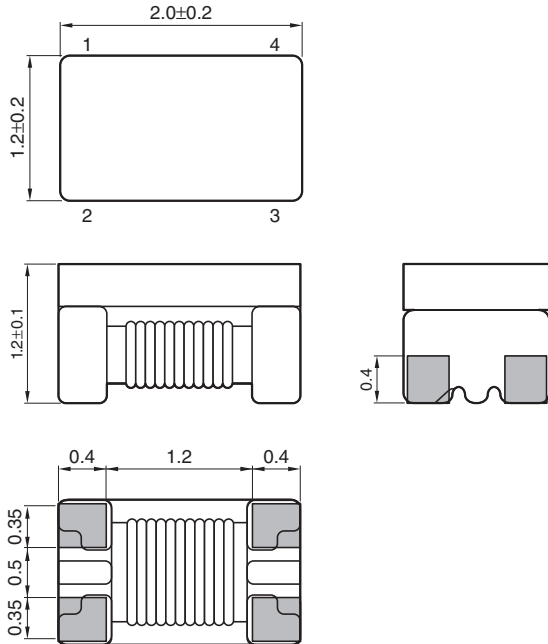

Dimensions in mm

RECOMMENDED LAND PATTERN

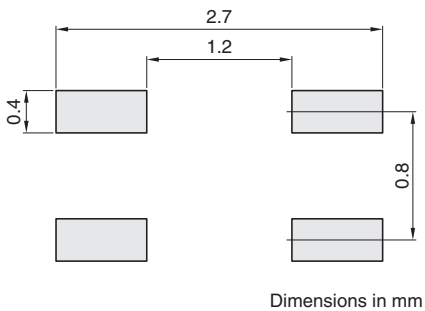

Dimensions in mm

CIRCUIT DIAGRAM

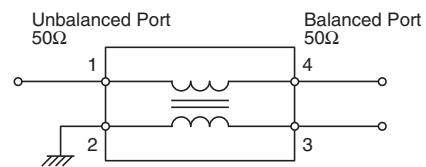

ATB series ATB2012-50011 Type

ELECTRICAL CHARACTERISTICS

CHARACTERISTICS SPECIFICATION TABLE

Frequency range (MHz)	UB/B impedance (Ω)	Insertion loss (dB)		CMRR min.	DC resistance (Ω)max.	Rated current (mA)	Rated voltage (V)	Insulation resistance (M Ω)	Withstanding voltage (V)	Part No.
		typ.	max.							
40 to 860	50/50	1.0	2.5	20	1.0	200	20	10	125	ATB2012-50011-T□□□

○ Measurement equipment

Measurement item	Product No.	Manufacturer
DC resistance	4338A	Agilent Technologies
Insulation resistance	4339A	Agilent Technologies
Insertion loss	E5071B	Agilent Technologies
Return loss	E5071B	Agilent Technologies
Amplitude imbalance	E5071B	Agilent Technologies
Phase balance	E5071B	Agilent Technologies

* Equivalent measurement equipment may be used.

FREQUENCY CHARACTERISTICS

INSERTION LOSS

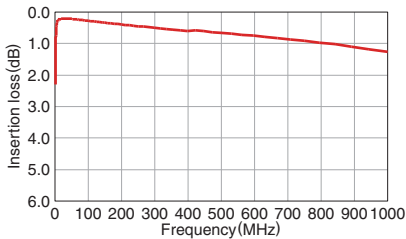

RETURN LOSS

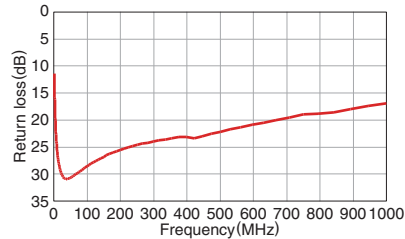

AMPLITUDE IMBALANCE

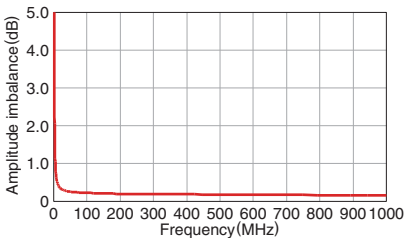

PHASE BALANCE

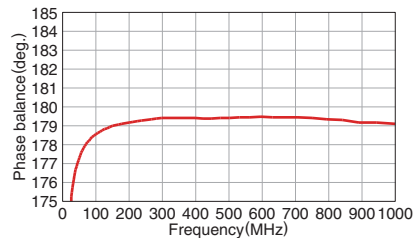

• All specifications are subject to change without notice.

ATB series

ATB2012E-50011M Type



■ SHAPE & DIMENSIONS

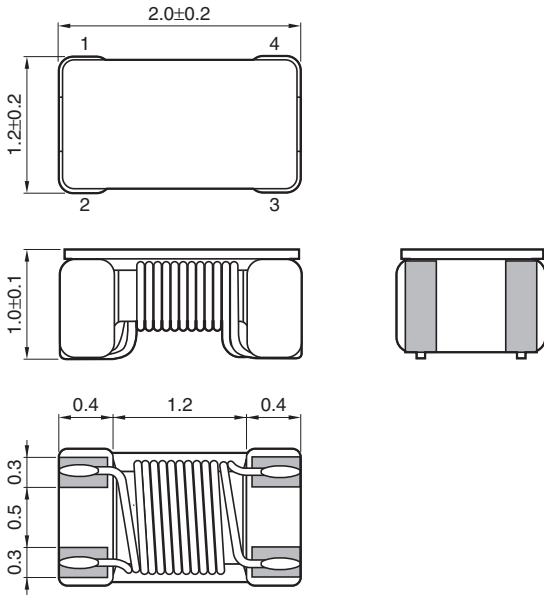

Dimensions in mm

■ RECOMMENDED LAND PATTERN

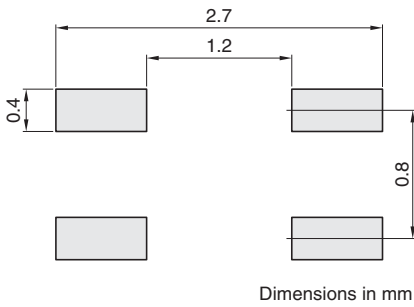

Dimensions in mm

■ CIRCUIT DIAGRAM

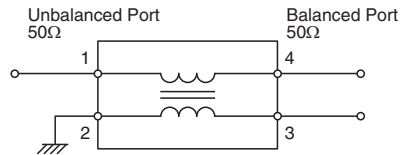

• All specifications are subject to change without notice.

ATB series ATB2012E-50011M Type

ELECTRICAL CHARACTERISTICS

CHARACTERISTICS SPECIFICATION TABLE

Frequency range (MHz)	UB/B impedance (Ω)	Insertion loss (dB)		CMRR min.	DC resistance (Ω)max.	Rated current (mA)	Rated voltage (V)	Insulation resistance (M Ω)	Withstanding voltage (V)	Part No.
		typ.	max.							
400 to 1800	50/50	1.0	2.2	15	0.5	150	20	10	125	ATB2012E-50011M-T□□

Measurement equipment

Measurement item	Product No.	Manufacturer
DC resistance	4338A	Agilent Technologies
Insulation resistance	4339A	Agilent Technologies
Insertion loss	E5071B	Agilent Technologies
Return loss	E5071B	Agilent Technologies
Amplitude imbalance	E5071B	Agilent Technologies
Phase balance	E5071B	Agilent Technologies

* Equivalent measurement equipment may be used.

FREQUENCY CHARACTERISTICS

INSERTION LOSS

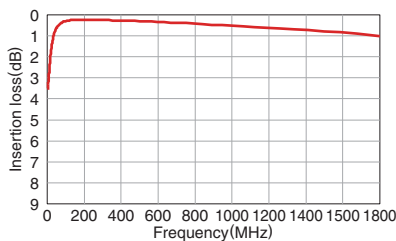

RETURN LOSS

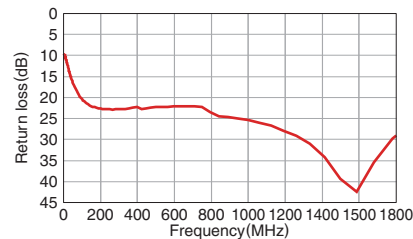

AMPLITUDE IMBALANCE

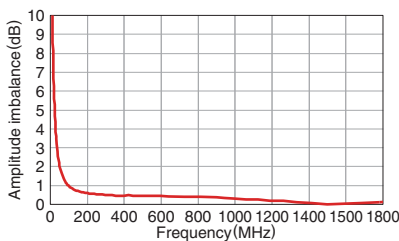

PHASE BALANCE

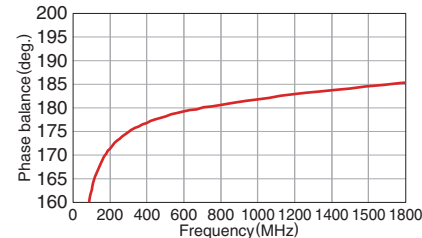

• All specifications are subject to change without notice.

ATB series

ATB2012-75011Type



SHAPE & DIMENSIONS

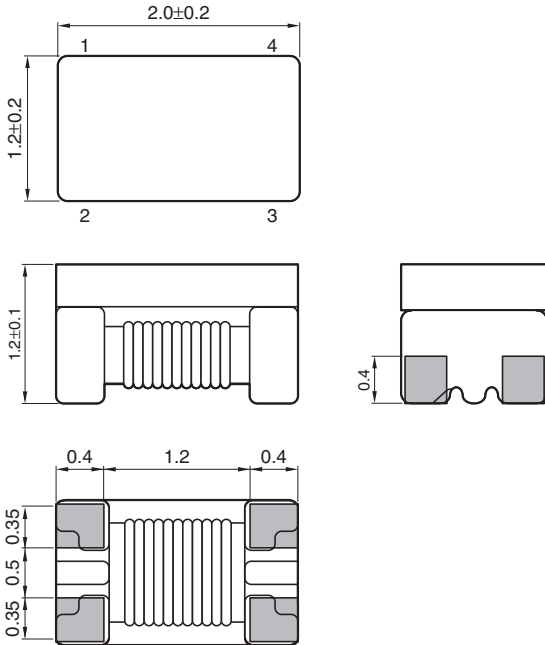

Dimensions in mm

RECOMMENDED LAND PATTERN

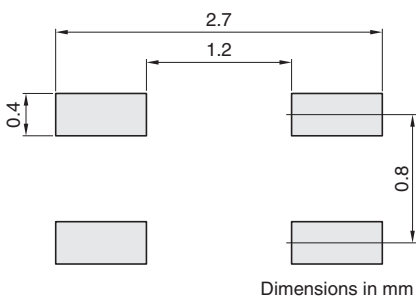

CIRCUIT DIAGRAM

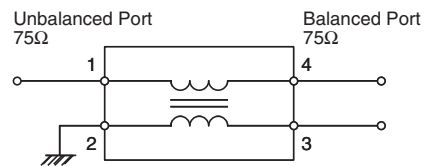

• All specifications are subject to change without notice.

ATB series ATB2012-75011 Type

ELECTRICAL CHARACTERISTICS

CHARACTERISTICS SPECIFICATION TABLE

Frequency range (MHz)	UB/B impedance (Ω)	Insertion loss (dB)		CMRR min.	DC resistance (Ω)	Rated current (mA)	Rated voltage (V)	Insulation resistance (M Ω)	Withstanding voltage (V)	Part No.
		typ.	max.							
50 to 1200	75/75	0.8	1.2	20	0.7	280	20	10	125	ATB2012-75011-T□□□

○ Measurement equipment

Measurement item	Product No.	Manufacturer
DC resistance	4338A	Agilent Technologies
Insulation resistance	4339A	Agilent Technologies
Insertion loss	E5071B	Agilent Technologies
Return loss	E5071B	Agilent Technologies
Amplitude imbalance	E5071B	Agilent Technologies
Phase balance	E5071B	Agilent Technologies

* Equivalent measurement equipment may be used.

FREQUENCY CHARACTERISTICS

INSERTION LOSS

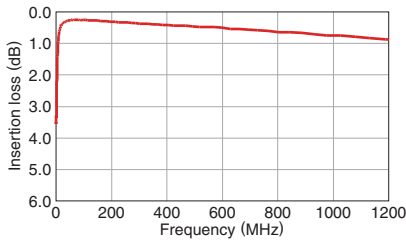

RETURN LOSS

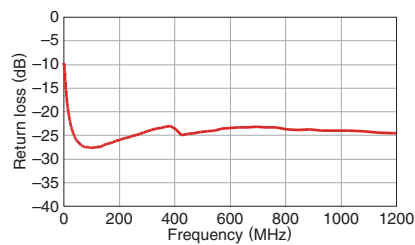

AMPLITUDE IMBALANCE

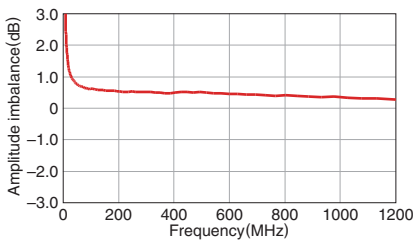

PHASE BALANCE

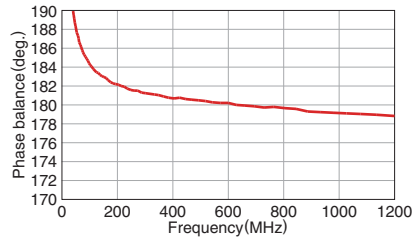

• All specifications are subject to change without notice.

ATB series

ATB2012E-75011M Type



SHAPE & DIMENSIONS

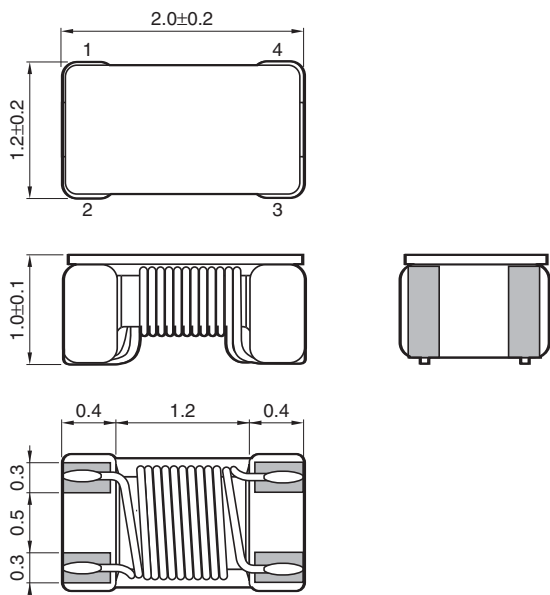

Dimensions in mm

RECOMMENDED LAND PATTERN

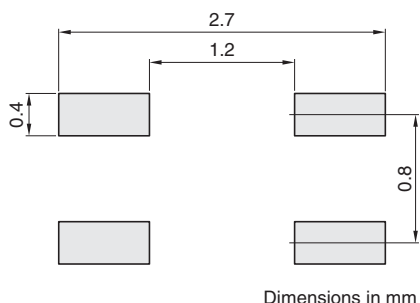

Dimensions in mm

CIRCUIT DIAGRAM

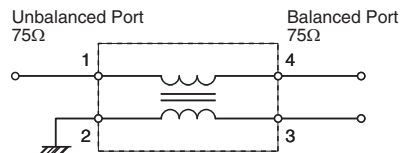

• All specifications are subject to change without notice.

ATB series ATB2012E-75011M Type

ELECTRICAL CHARACTERISTICS

CHARACTERISTICS SPECIFICATION TABLE

Frequency range (MHz)	UB/B impedance (Ω)	Insertion loss (dB)		CMRR min.	DC resistance (Ω)max.	Rated current (mA)	Rated voltage (V)	Insulation resistance (M Ω)	Withstanding voltage (V)	Part No.
		typ.	max.							
400 to 1800	75/75	1.0	2	15	0.5	150	20	10	125	ATB2012E-75011M-T□□

Measurement equipment

Measurement item	Product No.	Manufacturer
DC resistance	4338A	Agilent Technologies
Insulation resistance	4339A	Agilent Technologies
Insertion loss	E5071B	Agilent Technologies
Return loss	E5071B	Agilent Technologies
Amplitude imbalance	E5071B	Agilent Technologies
Phase balance	E5071B	Agilent Technologies

* Equivalent measurement equipment may be used.

FREQUENCY CHARACTERISTICS

INSERTION LOSS

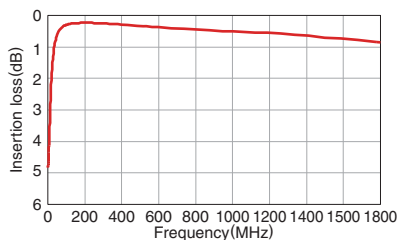

RETURN LOSS

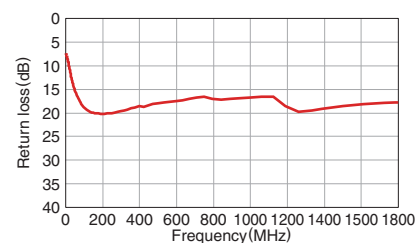

AMPLITUDE IMBALANCE

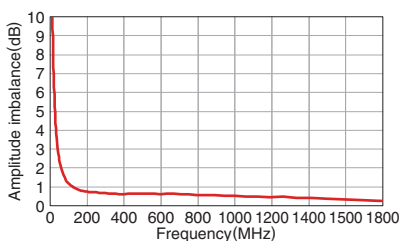

PHASE BALANCE

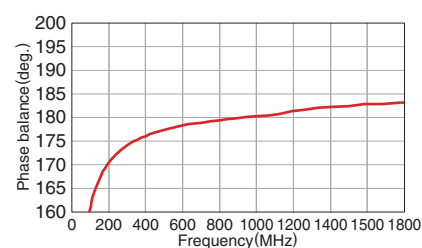

• All specifications are subject to change without notice.

ATB series

Packaging style

REEL DIMENSIONS

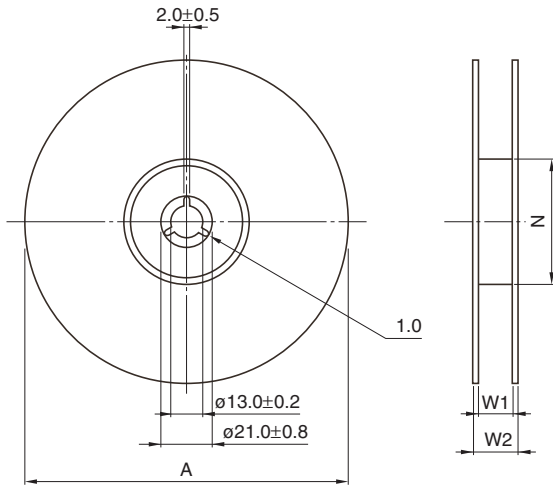

Dimensions in mm

Type	A	W1	W2	N
ATB2012-50011	ø180	13	60	9
	ø330	13.5	100	10
ATB2012-75011	ø180	13	60	9
	ø330	13.5	100	10
ATB2012E-50011M	ø180	13	60	9
	ø330	13.5	100	10
ATB2012E-75011M	ø180	13	60	9
	ø330	13.5	100	10

TAPE DIMENSIONS

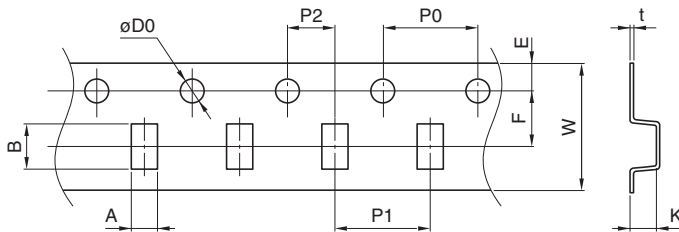

Dimensions in mm

Type	A	B	øD0	E	F	P0	P1	P2	W	K	t
ATB2012-50011	1.4±0.1	2.25±0.1	1.5+0.1/0	1.75±0.1	3.5±0.1	4.0±0.1	4.0±0.1	2.0±0.1	8.0±0.2	1.4±0.1	0.25±0.05
ATB2012-75011	1.4±0.1	2.25±0.1	1.5+0.1/0	1.75±0.1	3.5±0.1	4.0±0.1	4.0±0.1	2.0±0.1	8.0±0.2	1.4±0.1	0.25±0.05
ATB2012E-50011M	1.4±0.1	2.25±0.1	1.5+0.1/0	1.75±0.1	3.5±0.1	4.0±0.1	4.0±0.1	2.0±0.1	8.0±0.2	1.15±0.1	0.2±0.05
ATB2012E-75011M	1.4±0.1	2.25±0.1	1.5+0.1/0	1.75±0.1	3.5±0.1	4.0±0.1	4.0±0.1	2.0±0.1	8.0±0.2	1.15±0.1	0.2±0.05

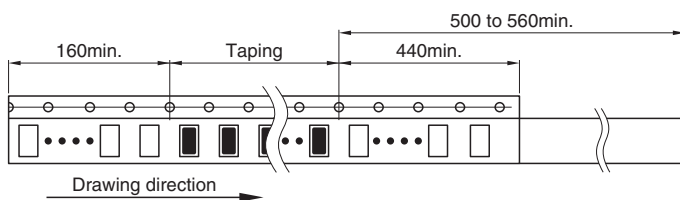

Dimensions in mm

• All specifications are subject to change without notice.