

SPECIFICATION

SPEC. No. A-SoftC-a

D A T E : 2013 Sep.

To

Non-Controlled Copy

CUSTOMER'S PRODUCT NAME

TDK PRODUCT NAME

MULTILAYER CERAMIC CHIP CAPACITORS
CGA Series / Automotive Grade
Soft Termination

Please return this specification to TDK representatives.

If orders are placed without returned specification, please allow us to judge that specification is accepted by your side.

RECEIPT CONFIRMATION

DATE: _____ YEAR _____ MONTH _____ DAY _____

TDK Corporation
Sales
Electronic Components
Sales & Marketing Group

TDK-EPC Corporation
Engineering
Ceramic Capacitors Business Group

APPROVED	Person in charge

APPROVED	CHECKED	Person in charge

1. SCOPE

This specification is applicable to chip type multilayer ceramic capacitors with a priority over the other relevant specifications.

Production places defined in this specification shall be TDK-EPC Corporation Japan, TDK(Suzhou)Co.,Ltd and TDK Components U.S.A. Inc.

EXPLANATORY NOTE:

This specification warrants the quality of the ceramic chip capacitors. The chips should be evaluated or confirmed a state of mounted on your product.

If the use of the chips goes beyond the bounds of the specification, we can not afford to guarantee.

2. CODE CONSTRUCTION

(Example)

Catalog Number : CGA4 J 3 X7R 1C 475 M 125 A E
 (Web) (1) (2) (3) (4) (5) (6) (7) (8) (9) (10)

Item Description : CGA4 J 3 X7R 1C 475 M T ○○○S
 (1) (2) (3) (4) (5) (6) (7) (11) (12)

(1) Type

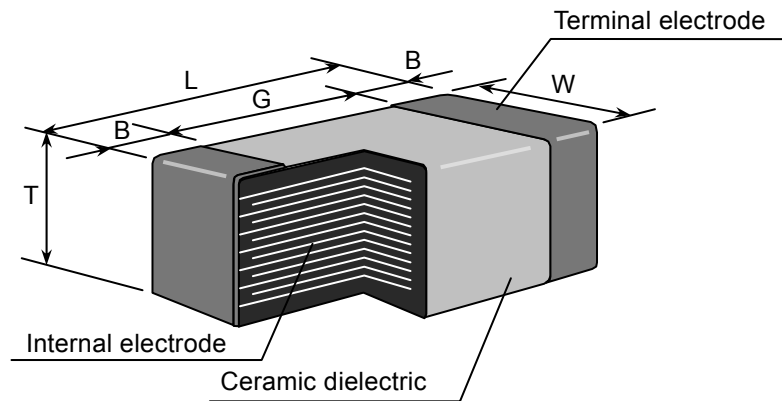

Please refer to product list for the dimension of each product.

(2) Thickness

*As for dimension tolerance, please contact with our sales representative.

Thickness	Dimension(mm)
F	0.85
H	1.15
J	1.25
K	1.30
L	1.60
M	2.00
N	2.30
P	2.50

(3) Voltage condition in the life test

(Max. operating Temp./1000h)

Sign	Condition
1	Rated Voltage x 1
2	Rated Voltage x 2
3	Rated Voltage x 1.5
4	Rated Voltage x 1.2

(4) Temperature Characteristics (Details are shown in table 1 No.6 at page 6)

(5) Rated Voltage

Symbol	Rated Voltage
2 J	DC 630 V
2 W	DC 450 V
2 E	DC 250 V
2 A	DC 100 V
1 H	DC 50 V
1 V	DC 35 V
1 E	DC 25 V
1 C	DC 16 V

(6) Rated Capacitance

Stated in three digits and in units of pico farads (pF).

The first and Second digits identify the first and second significant figures of the capacitance, the third digit identifies the multiplier.

R is designated for a decimal point.

Example 475 → 4,700,000pF (4.7uF)

(7) Capacitance tolerance

* M tolerance shall be TDK standard for over 10uF.

Symbol	Tolerance
K	± 10 %
M	± 20 %

(8) Thickness code (Only Catalog Number)

(9) Package code (Only Catalog Number)

(10) Special code (Only Catalog Number)

(11) Packaging

Symbol	Packaging
B	Bulk
T	Taping

(12) TDK Internal code

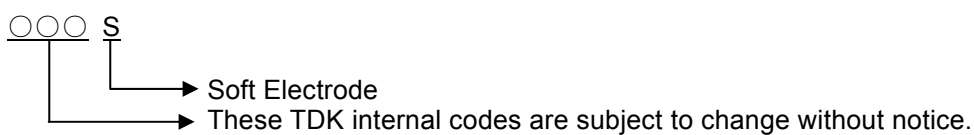

3. RATED CAPACITANCE AND CAPACITANCE TOLERANCE

3.1 Standard combination of rated capacitance and tolerances

Temperature Characteristics	Capacitance tolerance	Rated capacitance
X7R X7S X7T	K ($\pm 10\%$) M ($\pm 20\%$)	E – 3 series

* The standard capacitance tolerance is M ($\pm 20\%$).

3.2 Capacitance Step in E series

E series	Capacitance Step		
E- 3	1.0	2.2	4.7

4. OPERATING TEMPERATURE RANGE

T.C.	Min. operating Temperature	Max. operating Temperature	Reference Temperature
X7R X7S X7T	-55°C	125°C	25°C

5. STORING CONDITION AND TERM

5 to 40°C at 20 to 70%RH

6 months Max.

6. P.C. BOARD

When mounting on an aluminum substrate, large case sizes such as CGA6, CGA8 and CGA9 types are more likely to be affected by heat stress from the substrate. Please inquire separate specification for the large case sizes when mounted on the substrate.

7. INDUSTRIAL WASTE DISPOSAL

Dispose this product as industrial waste in accordance with the Industrial Waste Law.

8. PERFORMANCE

table 1

No.	Item	Performance	Test or inspection method														
1	External Appearance	No defects which may affect performance.	Inspect with magnifying glass (3×).														
2	Insulation Resistance	10,000MΩ or 500MΩ·μF min. (As for the capacitors of rated voltage 16V DC, 10,000 MΩ or 100MΩ·μF min.,) whichever smaller.	Apply rated voltage for 60s. As for the rated voltage 630V DC, apply 500V DC.														
3	Voltage Proof	Withstand test voltage without insulation breakdown or other damage.	<table border="1"> <thead> <tr> <th>Rated voltage</th> <th>Apply voltage</th> </tr> </thead> <tbody> <tr> <td>100V and under</td> <td>2.5 × rated voltage</td> </tr> <tr> <td>Over 100V</td> <td>1.5 × rated voltage</td> </tr> </tbody> </table> <p>Above DC voltage shall be applied for 1 to 5s. Charge / discharge current shall not exceed 50mA.</p>	Rated voltage	Apply voltage	100V and under	2.5 × rated voltage	Over 100V	1.5 × rated voltage								
Rated voltage	Apply voltage																
100V and under	2.5 × rated voltage																
Over 100V	1.5 × rated voltage																
4	Capacitance	Within the specified tolerance.	<table border="1"> <thead> <tr> <th>Rated Capacitance</th> <th>Measuring frequency</th> <th>Measuring voltage</th> </tr> </thead> <tbody> <tr> <td>10uF and under</td> <td>1kHz±10%</td> <td>1.0±0.2Vrms.</td> </tr> </tbody> </table>	Rated Capacitance	Measuring frequency	Measuring voltage	10uF and under	1kHz±10%	1.0±0.2Vrms.								
Rated Capacitance	Measuring frequency	Measuring voltage															
10uF and under	1kHz±10%	1.0±0.2Vrms.															
5	Dissipation Factor	<table border="1"> <thead> <tr> <th>T.C.</th> <th>D.F.</th> </tr> </thead> <tbody> <tr> <td>X7R</td> <td>0.03 max. 0.05 max. 0.075 max.</td> </tr> <tr> <td>X7S</td> <td>0.05 max.</td> </tr> <tr> <td>X7T</td> <td>0.025 max.</td> </tr> </tbody> </table>	T.C.	D.F.	X7R	0.03 max. 0.05 max. 0.075 max.	X7S	0.05 max.	X7T	0.025 max.	<p>See No.4 in this table for measuring condition.</p> <p>For information which product has which Dissipation Factor, please contact with our sales representative.</p>						
T.C.	D.F.																
X7R	0.03 max. 0.05 max. 0.075 max.																
X7S	0.05 max.																
X7T	0.025 max.																
6	Temperature Characteristics of Capacitance	<p>Capacitance Change (%)</p> <table border="1"> <thead> <tr> <th>No voltage applied</th> </tr> </thead> <tbody> <tr> <td>X7R : ±15</td> </tr> <tr> <td>X7S : ±22</td> </tr> <tr> <td>X7T : +22 -33</td> </tr> </tbody> </table>	No voltage applied	X7R : ±15	X7S : ±22	X7T : +22 -33	<p>Capacitance shall be measured by the steps shown in the following table after thermal equilibrium is obtained for each step.</p> <p>ΔC be calculated ref. STEP3 reading</p> <table border="1"> <thead> <tr> <th>Step</th> <th>Temperature(°C)</th> </tr> </thead> <tbody> <tr> <td>1</td> <td>Reference temp. ± 2</td> </tr> <tr> <td>2</td> <td>Min. operating temp. ± 2</td> </tr> <tr> <td>3</td> <td>Reference temp. ± 2</td> </tr> <tr> <td>4</td> <td>Max. operating temp. ± 2</td> </tr> </tbody> </table>	Step	Temperature(°C)	1	Reference temp. ± 2	2	Min. operating temp. ± 2	3	Reference temp. ± 2	4	Max. operating temp. ± 2
No voltage applied																	
X7R : ±15																	
X7S : ±22																	
X7T : +22 -33																	
Step	Temperature(°C)																
1	Reference temp. ± 2																
2	Min. operating temp. ± 2																
3	Reference temp. ± 2																
4	Max. operating temp. ± 2																

(continued)

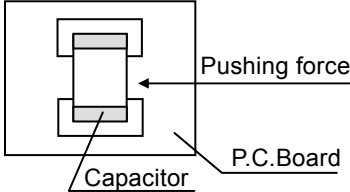
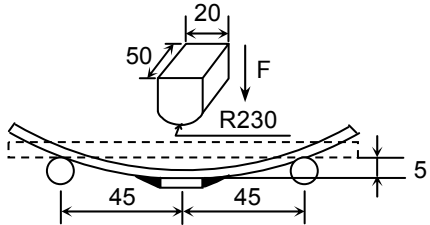
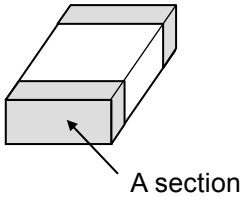
No.	Item	Performance	Test or inspection method
7	Robustness of Terminations	No sign of termination coming off, breakage of ceramic, or other abnormal signs.	<p>Reflow solder the capacitors on a P.C.Board shown in Appendix 1a or Appendix 1b and apply a pushing force of 17.7N with 10±1s.</p>  <p>The diagram shows a rectangular capacitor mounted on a P.C. Board. A horizontal arrow labeled 'Pushing force' points to the right, indicating the direction of the applied force. Labels 'Capacitor' and 'P.C.Board' are present with leader lines pointing to their respective parts.</p>
8	Bending	No mechanical damage.	<p>Reflow solder the capacitors on a P.C.Board shown in Appendix 2 and bend it for 5mm. (2mm is applied for CGA8 and CGA9.)</p>  <p>The diagram illustrates a capacitor on a P.C. Board being bent downwards. A downward arrow labeled 'F' represents the applied force. Dimensions are given in millimeters: a width of 20 mm, a height of 50 mm, a radius of curvature R230, and two 45 mm segments for the base. A vertical dimension of 5 mm is shown at the right end. The text '(Unit : mm)' is located below the diagram.</p>
9	Solderability	<p>New solder to cover over 75% of termination. 25% may have pin holes or rough spots but not concentrated in one spot. Ceramic surface of A sections shall not be exposed due to melting or shifting of termination material.</p>  <p>The diagram shows a 3D perspective view of a rectangular capacitor termination. An arrow points to the top surface, which is labeled 'A section'.</p>	<p>Completely soak both terminations in solder at 235±5°C for 2±0.5s.</p> <p>Solder : H63A (JIS Z 3282)</p> <p>Flux: Isopropyl alcohol (JIS K 8839) Rosin (JIS K 5902) 25% solid solution.</p>

(continued)

No.	Item		Performance	Test or inspection method	
10	Resistance to solder heat	External appearance	No cracks are allowed and terminations shall be covered at least 60% with new solder.	Completely soak both terminations in solder at 260±5°C for 5±1s. Preheating condition Temp. : 150±10°C Time : 1 to 2min. Flux : Isopropyl alcohol (JIS K 8839) Rosin (JIS K 5902) 25% solid solution. Solder : H63A (JIS Z 3282) Leave the capacitors in ambient condition for 24±2h before measurement.	
		Capacitance	Characteristics		Change from the value before test
			X7R X7S X7T		± 7.5 %
		D.F.	Meet the initial spec.		
		Insulation Resistance	Meet the initial spec.		
Voltage proof	No insulation breakdown or other damage.				
11	Vibration	External appearance	No mechanical damage.	Reflow solder the capacitors on a P.C.Board shown in Appendix 1a or Appendix 1b before testing. Vibrate the capacitor with following conditions. Applied force : 5G max. Frequency : 10-2000Hz Duration : 20 min. Cycle : 12 cycles in each 3 mutually perpendicular directions.	
		Capacitance	Characteristics		Change from the value before test
			X7R X7S X7T		± 7.5 %
D.F.	Meet the initial spec.				

(continued)

No.	Item		Performance	Test or inspection method															
12	Temperature cycle	External appearance	No mechanical damage.	<p>Reflow solder the capacitors on a P.C.Board shown in Appendix 1a or Appendix 1b before testing.</p> <p>Expose the capacitors in the condition step1 through step 4 and repeat 1,000 times consecutively.</p> <p>Leave the capacitors in ambient condition for 24±2h before measurement.</p> <table border="1"> <thead> <tr> <th>Step</th> <th>Temperature(°C)</th> <th>Time (min.)</th> </tr> </thead> <tbody> <tr> <td>1</td> <td>Min. operating temp. ± 3</td> <td>30 ± 3</td> </tr> <tr> <td>2</td> <td>Reference Temp.</td> <td>2 - 5</td> </tr> <tr> <td>3</td> <td>Max. operating temp. ± 2</td> <td>30 ± 2</td> </tr> <tr> <td>4</td> <td>Reference Temp.</td> <td>2 - 5</td> </tr> </tbody> </table>	Step	Temperature(°C)	Time (min.)	1	Min. operating temp. ± 3	30 ± 3	2	Reference Temp.	2 - 5	3	Max. operating temp. ± 2	30 ± 2	4	Reference Temp.	2 - 5
		Step	Temperature(°C)		Time (min.)														
		1	Min. operating temp. ± 3		30 ± 3														
		2	Reference Temp.		2 - 5														
		3	Max. operating temp. ± 2		30 ± 2														
4	Reference Temp.	2 - 5																	
Capacitance	<table border="1"> <thead> <tr> <th>Characteristics</th> <th>Change from the value before test</th> </tr> </thead> <tbody> <tr> <td>X7R</td> <td>± 7.5 %</td> </tr> <tr> <td>X7S</td> <td>± 12.5 %</td> </tr> <tr> <td>X7T</td> <td></td> </tr> </tbody> </table>	Characteristics	Change from the value before test	X7R	± 7.5 %	X7S	± 12.5 %	X7T											
Characteristics	Change from the value before test																		
X7R	± 7.5 %																		
X7S	± 12.5 %																		
X7T																			
D.F.	Meet the initial spec.																		
Insulation Resistance	Meet the initial spec.																		
Voltage proof	No insulation breakdown or other damage.																		
13	Moisture Resistance (Steady State)	External appearance	No mechanical damage.	<p>Reflow solder the capacitors on a P.C.Board shown in Appendix 1a or Appendix 1b before testing.</p> <p>Leave at temperature 40±2°C, 90 to 95%RH for 500 +24,0h.</p> <p>Leave the capacitors in ambient condition for 24±2h before measurement.</p>															
		Capacitance	<table border="1"> <thead> <tr> <th>Characteristics</th> <th>Change from the value before test</th> </tr> </thead> <tbody> <tr> <td>X7R</td> <td>± 12.5 %</td> </tr> <tr> <td>X7S</td> <td>± 25 %</td> </tr> <tr> <td>X7T</td> <td></td> </tr> </tbody> </table>		Characteristics	Change from the value before test	X7R	± 12.5 %	X7S	± 25 %	X7T								
		Characteristics	Change from the value before test																
X7R	± 12.5 %																		
X7S	± 25 %																		
X7T																			
D.F.	Characteristics 200% of initial spec. max																		
	Insulation Resistance	1,000MΩ or 50MΩ·μF min. (As for the capacitors of rated voltage 16V DC, 1,000 MΩ or 10MΩ·μF min.,) whichever smaller.																	

(continued)

No.	Item		Performance		Test or inspection method
14	Moisture Resistance	External appearance	No mechanical damage.		Reflow solder the capacitors on a P.C.Board shown in Appendix 1a or Appendix 1b before testing.
		Capacitance	Characteristics	Change from the value before test	Apply the rated voltage at temperature 85°C and 85%RH for 1,000 +48,0h. Charge/discharge current shall not exceed 50mA.
			X7R X7S X7T	± 12.5 % ± 25 %	
		D.F.	Characteristics 200% of initial spec. max		Leave the capacitors in ambient condition for 6 to 24h (Class1) or 24±2h (Class2) before measurement. Voltage conditioning (only for class2) Voltage treat the capacitor under testing temperature and voltage for 1hour.
Insulation Resistance	500MΩ or 25MΩ·μF min. (As for the capacitors of rated voltage 16V DC, 500 MΩ or 5MΩ·μF min.,) whichever smaller.		Leave the capacitors in ambient condition for 24±2h before measurement. Use this measurement for initial value.		
15	Life	External appearance	No mechanical damage.		Reflow solder the capacitors on a P.C.Board shown in Appendix 1a or Appendix 1b before testing.
		Capacitance	Characteristics	Change from the value before test	Below the voltage shall be applied at 125±2°C for 1,000 +48, 0h. Applied voltage Rated voltage x2 Rated voltage x1.5 Rated voltage x1.2 Rated voltage x1
			X7R X7S X7T	± 15 % ± 25 %	
		D.F.	Characteristics 200% of initial spec. max		For information which product has which applied voltage, please contact with our sales representative. Charge/discharge current shall not exceed 50mA. Leave the capacitors in ambient condition for 6 to 24h (Class1) or 24±2h (Class2) before measurement. Voltage conditioning (only for class2) Voltage treat the capacitor under testing temperature and voltage for 1hour.
Insulation Resistance	1,000MΩ or 50MΩ·μF min. (As for the capacitors of rated voltage 16V DC, 1,000 MΩ or 10MΩ·μF min.,) whichever smaller.		Leave the capacitors in ambient condition for 24±2h before measurement. Use this measurement for initial value.		

*As for the initial measurement of capacitors on number 6,10,11,12 and 13, leave capacitors at 150 –10,0°C for 1 hour and measure the value after leaving capacitors for 24±2h in ambient condition.

Appendix - 1a

P.C. Board for reliability test

Applied for CGA4, CGA5

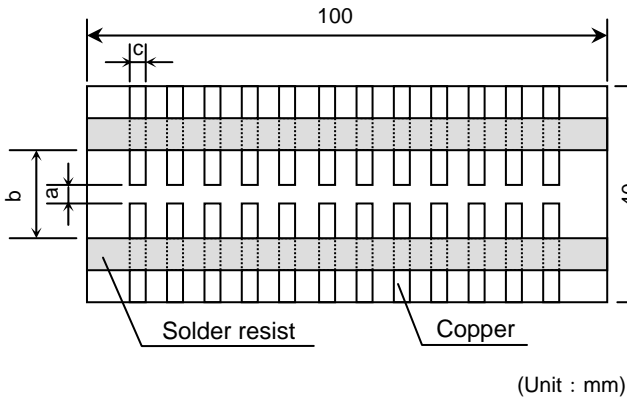

Appendix - 1b

P.C. Board for reliability test

Applied for CGA6, CGA8, CGA9

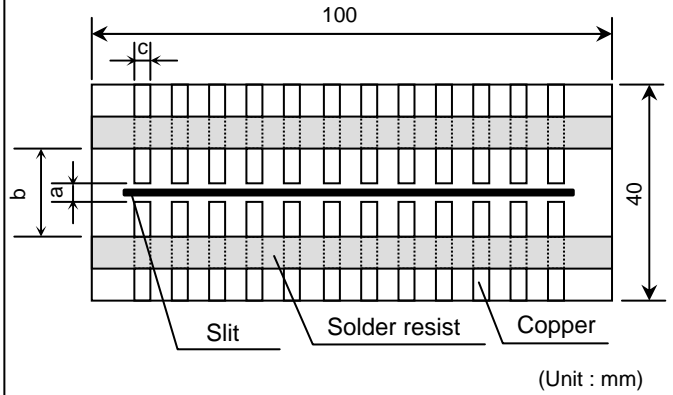

Appendix - 2

P.C. Board for bending test

Applied for CGA4, CGA5, CGA6, CGA8, CGA9

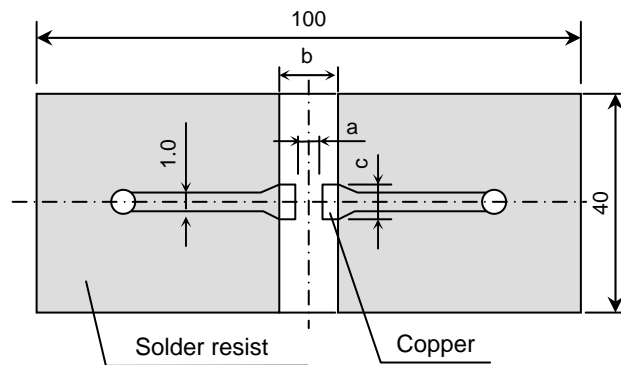

Material : Glass Epoxy (As per JIS C6484 GE4)

P.C. Board thickness : Appendix-1a, 1b, 2 1.6mm

- Copper (thickness 0.035mm)
- Solder resist

TDK (EIA style)	Dimensions (mm)		
	a	b	c
CGA4 (CC0805)	1.2	4.0	1.65
CGA5 (CC1206)	2.2	5.0	2.0
CGA6 (CC1210)	2.2	5.0	2.9
CGA8 (CC1812)	3.5	7.0	3.7
CGA9 (CC2220)	4.5	8.0	5.6

9. INSIDE STRUCTURE AND MATERIAL

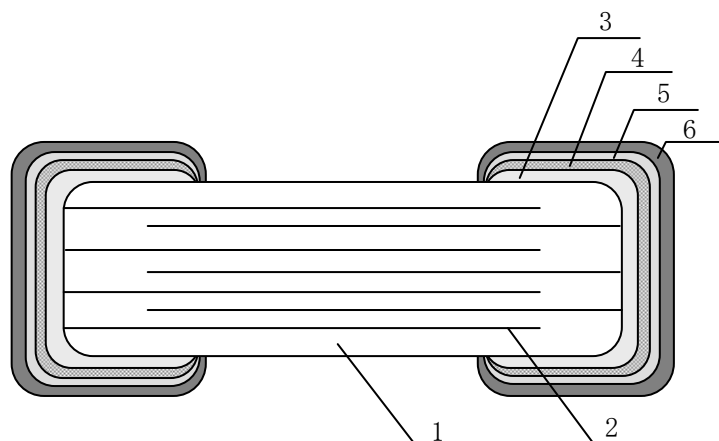

No.	NAME	MATERIAL
1	Dielectric	BaTiO ₃
2	Electrode	Nickel (Ni)
3	Termination	Copper (Cu)
4		Conductive resin (Filler : Ag)
5		Nickel (Ni)
6		Tin (Sn)

10. RECOMMENDATION

As for CGA6, CGA8 and CGA9 types, It is recommended to provide a slit (about 1mm wide) in the board under the components to improve washing Flux. And please make sure to dry detergent up completely before.

11. SOLDERING CONDITION

As for CGA6, CGA8 and CGA9 types, reflow soldering only.

12. Caution

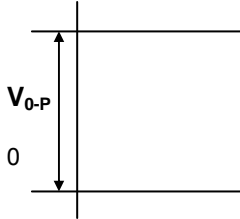
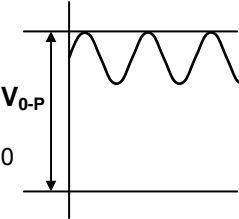
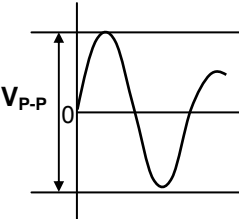
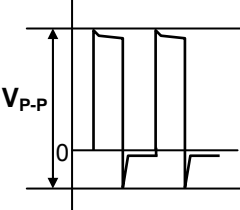
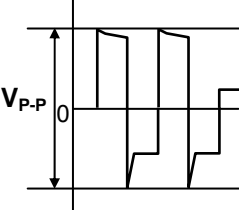
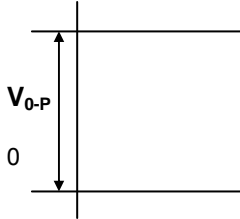
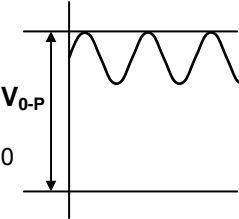
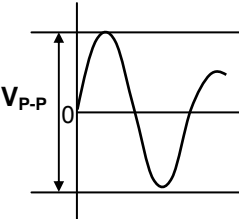
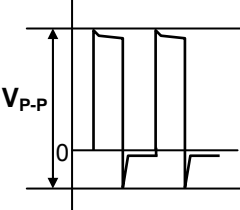
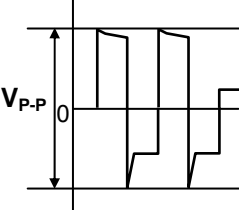
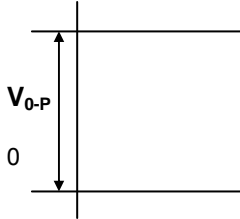
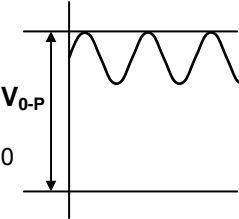
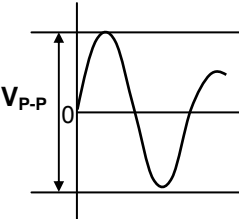
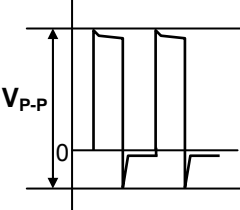
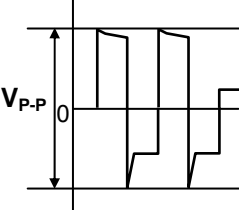
No.	Process	Condition														
1	Operating Condition (Storage, Transportation)	<p>1-1. Storage</p> <ol style="list-style-type: none"> 1) The capacitors must be stored in an ambient temperature of 5 to 40°C with a relative humidity of 20 to 70%RH. The products should be used within 6 months upon receipt. 2) The capacitors must be operated and stored in an environment free of dew condensation and these gases such as Hydrogen Sulphide, Hydrogen Sulphate, Chlorine, Ammonia and sulfur. 3) Avoid storing in sun light and falling of dew. 4) Do not use capacitors under high humidity and high and low atmospheric pressure which may affect capacitors reliability. 5) Capacitors should be tested for the solderability when they are stored for long time. <p>1-2. Handling in transportation</p> <p>In case of the transportation of the capacitors, the performance of the capacitors may be deteriorated depending on the transportation condition. (Refer to JEITA RCR-2335B 9.2 Handling in transportation)</p>														
2	Circuit design ⚠ Caution	<p>2-1. Operating temperature</p> <p>Operating temperature should be followed strictly within this specification, especially be careful with maximum temperature.</p> <ol style="list-style-type: none"> 1) Do not use capacitors above the maximum allowable operating temperature. 2) Surface temperature including self heating should be below maximum operating temperature. (Due to dielectric loss, capacitors will heat itself when AC is applied. Especially at high frequencies around its SRF, the heat might be so extreme that it may damage itself or the product mounted on. Please design the circuit so that the maximum temperature of the capacitors including the self heating to be below the maximum allowable operating temperature. Temperature rise at capacitor surface shall be below 20°C) 3) The electrical characteristics of the capacitors will vary depending on the temperature. The capacitors should be selected and designed in taking the temperature into consideration. <p>2-2. Operating voltage</p> <ol style="list-style-type: none"> 1) Operating voltage across the terminals should be below the rated voltage. When AC and DC are super imposed, V_{0-P} must be below the rated voltage. _____ (1) and (2) AC or pulse with overshooting, V_{P-P} must be below the rated voltage. _____ (3), (4) and (5) When the voltage is started to apply to the circuit or it is stopped applying, the irregular voltage may be generated for a transit period because of resonance or switching. Be sure to use the capacitors within rated voltage containing these Irregular voltage. <table border="1" data-bbox="472 1451 1445 1727"> <thead> <tr> <th data-bbox="472 1451 660 1496">Voltage</th> <th data-bbox="660 1451 922 1496">(1) DC voltage</th> <th data-bbox="922 1451 1184 1496">(2) DC+AC voltage</th> <th data-bbox="1184 1451 1445 1496">(3) AC voltage</th> </tr> </thead> <tbody> <tr> <td data-bbox="472 1496 660 1727">Positional Measurement (Rated voltage)</td> <td data-bbox="660 1496 922 1727">  </td> <td data-bbox="922 1496 1184 1727">  </td> <td data-bbox="1184 1496 1445 1727">  </td> </tr> </tbody> </table> <table border="1" data-bbox="472 1753 1184 2020"> <thead> <tr> <th data-bbox="472 1753 660 1798">Voltage</th> <th data-bbox="660 1753 922 1798">(4) Pulse voltage (A)</th> <th data-bbox="922 1753 1184 1798">(5) Pulse voltage (B)</th> </tr> </thead> <tbody> <tr> <td data-bbox="472 1798 660 2020">Positional Measurement (Rated voltage)</td> <td data-bbox="660 1798 922 2020">  </td> <td data-bbox="922 1798 1184 2020">  </td> </tr> </tbody> </table>	Voltage	(1) DC voltage	(2) DC+AC voltage	(3) AC voltage	Positional Measurement (Rated voltage)				Voltage	(4) Pulse voltage (A)	(5) Pulse voltage (B)	Positional Measurement (Rated voltage)		
Voltage	(1) DC voltage	(2) DC+AC voltage	(3) AC voltage													
Positional Measurement (Rated voltage)																
Voltage	(4) Pulse voltage (A)	(5) Pulse voltage (B)														
Positional Measurement (Rated voltage)																

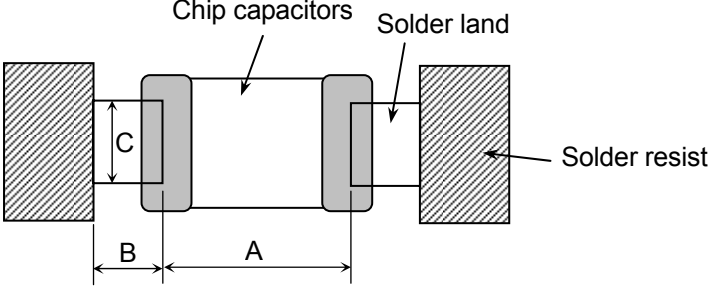
No.	Process	Condition																																								
2	Circuit design ⚠ Caution	<p>2) Even below the rated voltage, if repetitive high frequency AC or pulse is applied, the reliability of the capacitors may be reduced.</p> <p>3) The effective capacitance will vary depending on applied DC and AC voltages. The capacitors should be selected and designed in taking the voltages into consideration.</p> <p>2-3. Frequency When the capacitors (Class 2) are used in AC and/or pulse voltages, the capacitors may vibrate themselves and generate audible sound.</p>																																								
3	Designing P.C.board	<p>The amount of solder at the terminations has a direct effect on the reliability of the capacitors.</p> <p>1) The greater the amount of solder, the higher the stress on the chip capacitors, and the more likely that it will break. When designing a P.C.board, determine the shape and size of the solder lands to have proper amount of solder on the terminations.</p> <p>2) Avoid using common solder land for multiple terminations and provide individual solder land for each terminations.</p> <p>3) Size and recommended land dimensions.</p> <div style="text-align: center;">  <p>The diagram shows a cross-section of a chip capacitor mounted on a PCB. Dimension A is the length of the capacitor body, B is the length of the solder land, and C is the height of the solder land. Labels include 'Chip capacitors', 'Solder land', and 'Solder resist'.</p> </div> <p>Flow soldering (mm)</p> <table border="1" data-bbox="496 1176 1086 1395"> <thead> <tr> <th>Type</th> <th>CGA4 (CC0805)</th> <th>CGA5 (CC1206)</th> </tr> </thead> <tbody> <tr> <td>A</td> <td>1.0 - 1.3</td> <td>2.1 - 2.5</td> </tr> <tr> <td>B</td> <td>1.0 - 1.2</td> <td>1.1 - 1.3</td> </tr> <tr> <td>C</td> <td>0.8 - 1.1</td> <td>1.0 - 1.3</td> </tr> </tbody> </table> <p>Reflow soldering (mm)</p> <table border="1" data-bbox="480 1473 1031 1693"> <thead> <tr> <th>Type</th> <th>CGA4 (CC0805)</th> <th>CGA5 (CC1206)</th> </tr> </thead> <tbody> <tr> <td>A</td> <td>0.9 - 1.2</td> <td>2.0 - 2.4</td> </tr> <tr> <td>B</td> <td>0.7 - 0.9</td> <td>1.0 - 1.2</td> </tr> <tr> <td>C</td> <td>0.9 - 1.2</td> <td>1.1 - 1.6</td> </tr> </tbody> </table> <table border="1" data-bbox="480 1731 1222 1951"> <thead> <tr> <th>Type</th> <th>CGA6 (CC1210)</th> <th>CGA8 (CC1812)</th> <th>CGA9 (CC2220)</th> </tr> </thead> <tbody> <tr> <td>A</td> <td>2.0 - 2.4</td> <td>3.1 - 3.7</td> <td>4.1 - 4.8</td> </tr> <tr> <td>B</td> <td>1.0 - 1.2</td> <td>1.2 - 1.4</td> <td>1.2 - 1.4</td> </tr> <tr> <td>C</td> <td>1.9 - 2.5</td> <td>2.4 - 3.2</td> <td>4.0 - 5.0</td> </tr> </tbody> </table>	Type	CGA4 (CC0805)	CGA5 (CC1206)	A	1.0 - 1.3	2.1 - 2.5	B	1.0 - 1.2	1.1 - 1.3	C	0.8 - 1.1	1.0 - 1.3	Type	CGA4 (CC0805)	CGA5 (CC1206)	A	0.9 - 1.2	2.0 - 2.4	B	0.7 - 0.9	1.0 - 1.2	C	0.9 - 1.2	1.1 - 1.6	Type	CGA6 (CC1210)	CGA8 (CC1812)	CGA9 (CC2220)	A	2.0 - 2.4	3.1 - 3.7	4.1 - 4.8	B	1.0 - 1.2	1.2 - 1.4	1.2 - 1.4	C	1.9 - 2.5	2.4 - 3.2	4.0 - 5.0
Type	CGA4 (CC0805)	CGA5 (CC1206)																																								
A	1.0 - 1.3	2.1 - 2.5																																								
B	1.0 - 1.2	1.1 - 1.3																																								
C	0.8 - 1.1	1.0 - 1.3																																								
Type	CGA4 (CC0805)	CGA5 (CC1206)																																								
A	0.9 - 1.2	2.0 - 2.4																																								
B	0.7 - 0.9	1.0 - 1.2																																								
C	0.9 - 1.2	1.1 - 1.6																																								
Type	CGA6 (CC1210)	CGA8 (CC1812)	CGA9 (CC2220)																																							
A	2.0 - 2.4	3.1 - 3.7	4.1 - 4.8																																							
B	1.0 - 1.2	1.2 - 1.4	1.2 - 1.4																																							
C	1.9 - 2.5	2.4 - 3.2	4.0 - 5.0																																							

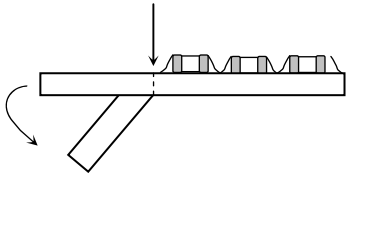
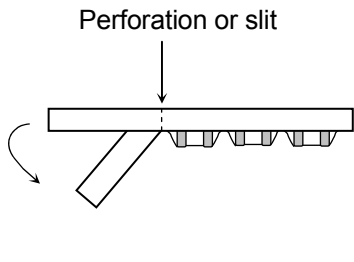
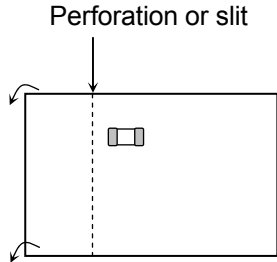
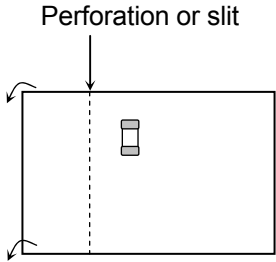
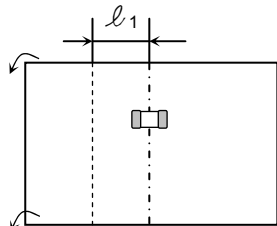
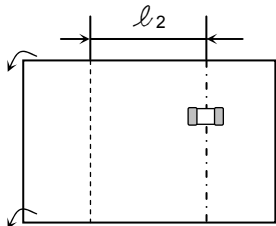
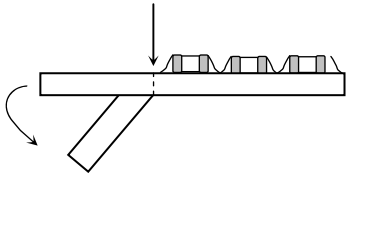
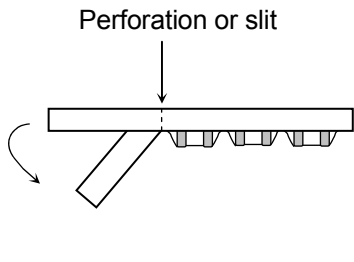
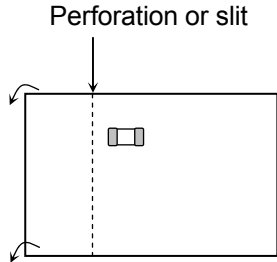
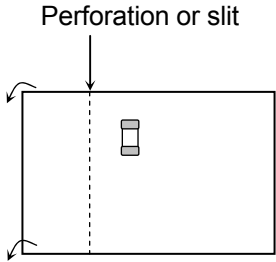
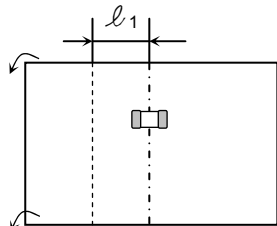
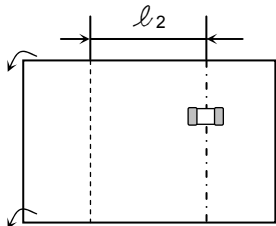
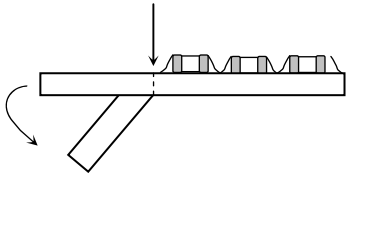
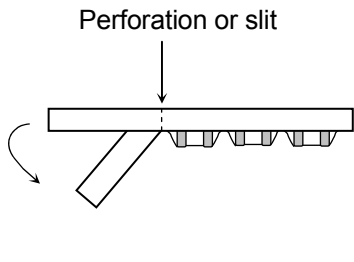
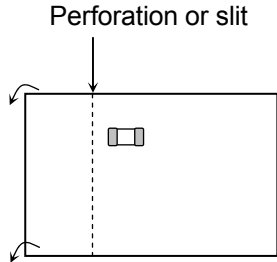
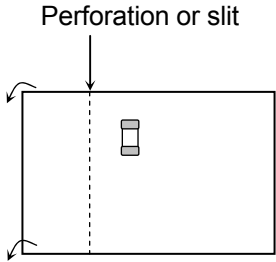
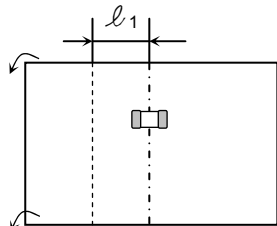
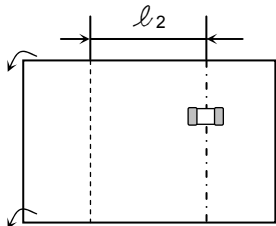
No.	Process	Condition												
3	Designing P.C.board	<p data-bbox="437 147 1098 179">4) Recommended chip capacitors layout is as following.</p> <table border="1" data-bbox="472 219 1426 1639"> <thead> <tr> <th data-bbox="472 219 660 295"></th> <th data-bbox="660 219 1043 295">Disadvantage against bending stress</th> <th data-bbox="1043 219 1426 295">Advantage against bending stress</th> </tr> </thead> <tbody> <tr> <td data-bbox="472 295 660 712">Mounting face</td> <td data-bbox="660 295 1043 712"> <p data-bbox="746 340 954 371">Perforation or slit</p>  <p data-bbox="699 609 954 676">Break P.C.board with mounted side up.</p> </td> <td data-bbox="1043 295 1426 712"> <p data-bbox="1136 340 1343 371">Perforation or slit</p>  <p data-bbox="1098 609 1353 676">Break P.C.board with mounted side down.</p> </td> </tr> <tr> <td data-bbox="472 712 660 1160">Chip arrangement (Direction)</td> <td data-bbox="660 712 1043 1160"> <p data-bbox="746 833 954 864">Perforation or slit</p>  </td> <td data-bbox="1043 712 1426 1160"> <p data-bbox="1136 833 1343 864">Perforation or slit</p>  </td> </tr> <tr> <td data-bbox="472 1160 660 1639">Distance from slit</td> <td data-bbox="660 1160 1043 1639"> <p data-bbox="673 1169 1008 1200">Closer to slit is higher stress</p>  <p data-bbox="880 1541 1008 1572">$(l_1 < l_2)$</p> </td> <td data-bbox="1043 1160 1426 1639"> <p data-bbox="1056 1169 1391 1200">Away from slit is less stress</p>  <p data-bbox="1264 1541 1391 1572">$(l_1 < l_2)$</p> </td> </tr> </tbody> </table>		Disadvantage against bending stress	Advantage against bending stress	Mounting face	<p data-bbox="746 340 954 371">Perforation or slit</p>  <p data-bbox="699 609 954 676">Break P.C.board with mounted side up.</p>	<p data-bbox="1136 340 1343 371">Perforation or slit</p>  <p data-bbox="1098 609 1353 676">Break P.C.board with mounted side down.</p>	Chip arrangement (Direction)	<p data-bbox="746 833 954 864">Perforation or slit</p> 	<p data-bbox="1136 833 1343 864">Perforation or slit</p> 	Distance from slit	<p data-bbox="673 1169 1008 1200">Closer to slit is higher stress</p>  <p data-bbox="880 1541 1008 1572">$(l_1 < l_2)$</p>	<p data-bbox="1056 1169 1391 1200">Away from slit is less stress</p>  <p data-bbox="1264 1541 1391 1572">$(l_1 < l_2)$</p>
	Disadvantage against bending stress	Advantage against bending stress												
Mounting face	<p data-bbox="746 340 954 371">Perforation or slit</p>  <p data-bbox="699 609 954 676">Break P.C.board with mounted side up.</p>	<p data-bbox="1136 340 1343 371">Perforation or slit</p>  <p data-bbox="1098 609 1353 676">Break P.C.board with mounted side down.</p>												
Chip arrangement (Direction)	<p data-bbox="746 833 954 864">Perforation or slit</p> 	<p data-bbox="1136 833 1343 864">Perforation or slit</p> 												
Distance from slit	<p data-bbox="673 1169 1008 1200">Closer to slit is higher stress</p>  <p data-bbox="880 1541 1008 1572">$(l_1 < l_2)$</p>	<p data-bbox="1056 1169 1391 1200">Away from slit is less stress</p>  <p data-bbox="1264 1541 1391 1572">$(l_1 < l_2)$</p>												

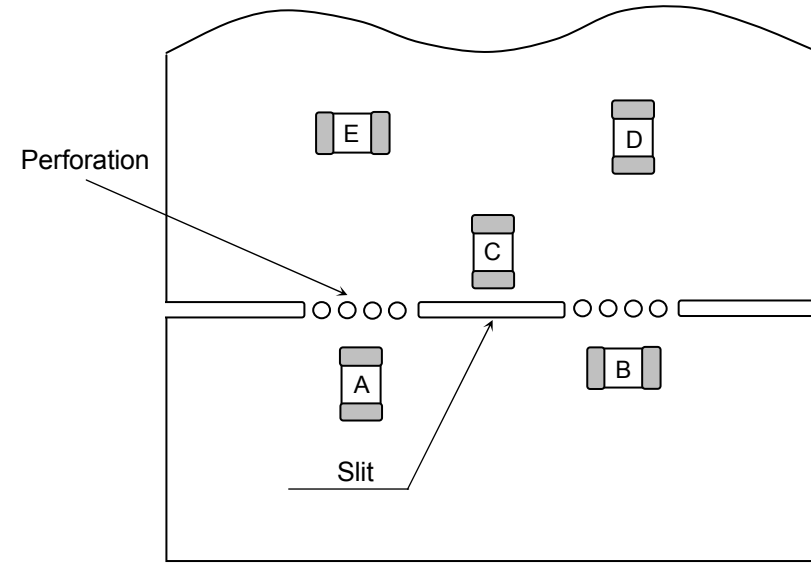
No.	Process	Condition												
3	Designing P.C.board	<p>5) Mechanical stress varies according to location of chip capacitors on the P.C.board.</p>  <p>The stress in capacitors is in the following order. $A > B = C > D > E$</p> <p>6) Layout recommendation</p> <table border="1"> <thead> <tr> <th data-bbox="379 1008 539 1120">Example</th> <th data-bbox="539 1008 842 1120">Use of common solder land</th> <th data-bbox="842 1008 1153 1120">Soldering with chassis</th> <th data-bbox="1153 1008 1481 1120">Use of common solder land with other SMD</th> </tr> </thead> <tbody> <tr> <td data-bbox="379 1120 539 1500">Need to avoid</td> <td data-bbox="539 1120 842 1500">  </td> <td data-bbox="842 1120 1153 1500">  </td> <td data-bbox="1153 1120 1481 1500">  </td> </tr> <tr> <td data-bbox="379 1500 539 1915">Recommendation</td> <td data-bbox="539 1500 842 1915">  </td> <td data-bbox="842 1500 1153 1915">  <p>$l^2 > l^1$</p> </td> <td data-bbox="1153 1500 1481 1915">  </td> </tr> </tbody> </table>	Example	Use of common solder land	Soldering with chassis	Use of common solder land with other SMD	Need to avoid				Recommendation		 <p>$l^2 > l^1$</p>	
Example	Use of common solder land	Soldering with chassis	Use of common solder land with other SMD											
Need to avoid														
Recommendation		 <p>$l^2 > l^1$</p>												

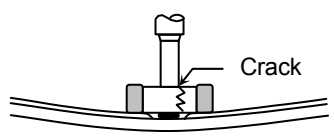
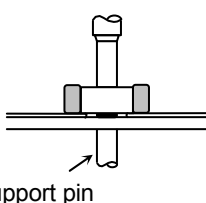
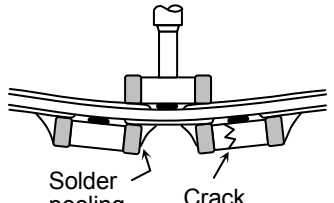
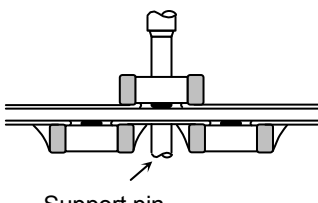
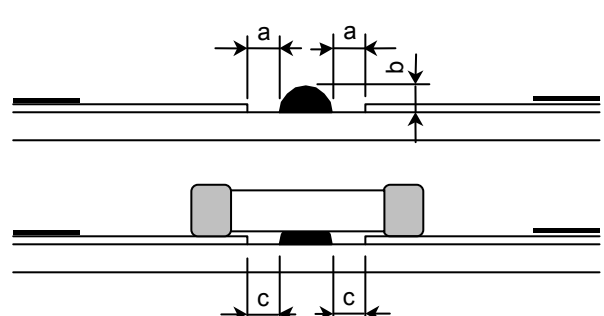
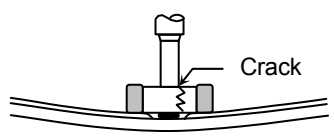
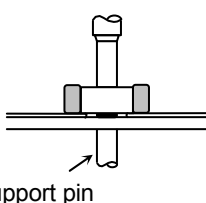
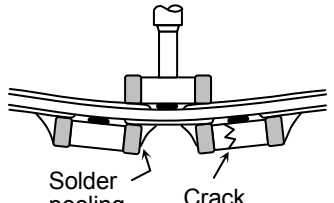
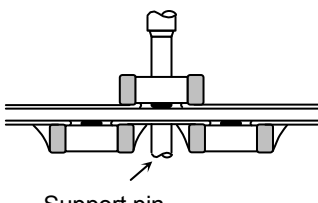
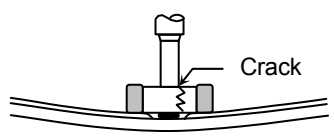
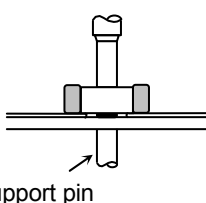
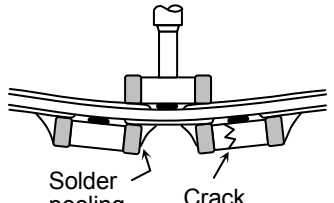
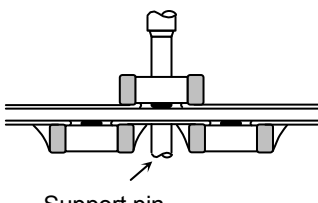
No.	Process	Condition															
4	Mounting	<p>4-1. Stress from mounting head</p> <p>If the mounting head is adjusted too low, it may induce excessive stress in the chip capacitors to result in cracking. Please take following precautions.</p> <ol style="list-style-type: none"> 1) Adjust the bottom dead center of the mounting head to reach on the P.C.board surface and not press it. 2) Adjust the mounting head pressure to be 1 to 3N of static weight. 3) To minimize the impact energy from mounting head, it is important to provide support from the bottom side of the P.C.board. <p>See following examples.</p> <table border="1" data-bbox="478 593 1436 1153"> <thead> <tr> <th></th> <th>Not recommended</th> <th>Recommended</th> </tr> </thead> <tbody> <tr> <td>Single sided mounting</td> <td></td> <td></td> </tr> <tr> <td>Double-sides mounting</td> <td></td> <td></td> </tr> </tbody> </table> <p>When the centering jaw is worn out, it may give mechanical impact on the capacitors to cause crack. Please control the close up dimension of the centering jaw and provide sufficient preventive maintenance and replacement of it.</p> <p>4-2. Amount of adhesive</p>  <p>Example : CGA4 (CC0805), CGA5 (CC1206)</p> <table border="1" data-bbox="654 1769 1212 1948"> <tbody> <tr> <td>a</td> <td>0.2mm min.</td> </tr> <tr> <td>b</td> <td>70 - 100μm</td> </tr> <tr> <td>c</td> <td>Do not touch the solder land</td> </tr> </tbody> </table>		Not recommended	Recommended	Single sided mounting			Double-sides mounting			a	0.2mm min.	b	70 - 100μm	c	Do not touch the solder land
	Not recommended	Recommended															
Single sided mounting																	
Double-sides mounting																	
a	0.2mm min.																
b	70 - 100μm																
c	Do not touch the solder land																

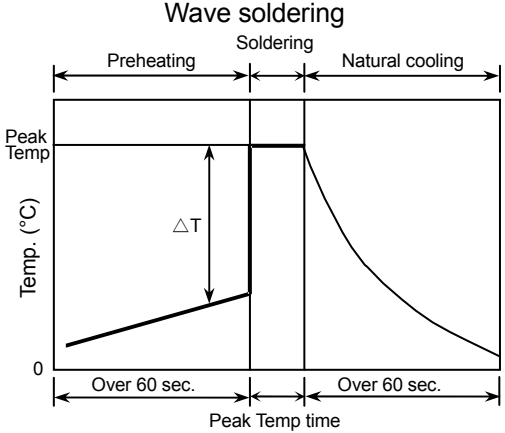
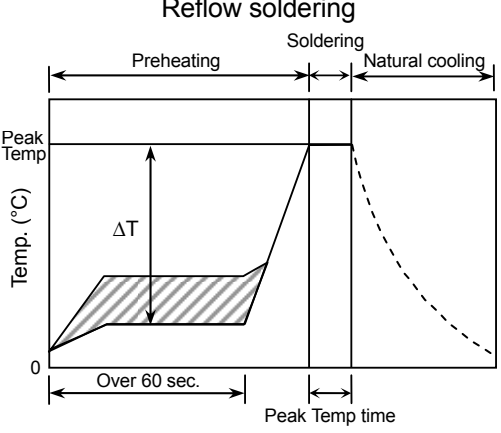
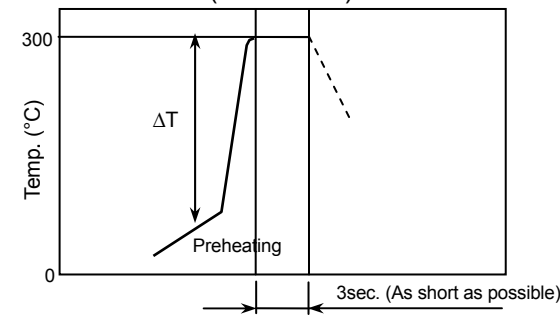
No.	Process	Condition																								
5	Soldering	<p>5-1. Flux selection</p> <p>Although highly-activated flux gives better solderability, substances which increase activity may also degrade the insulation of the chip capacitors. To avoid such degradation, it is recommended following.</p> <ol style="list-style-type: none"> 1) It is recommended to use a mildly activated rosin flux (less than 0.1wt% chlorine). Strong flux is not recommended. 2) Excessive flux must be avoided. Please provide proper amount of flux. 3) When water-soluble flux is used, enough washing is necessary. <p>5-2. Recommended soldering profile by various methods</p> <div style="display: flex; justify-content: space-around;"> <div style="text-align: center;"> <p>Wave soldering</p>  </div> <div style="text-align: center;"> <p>Reflow soldering</p>  </div> </div> <div style="text-align: center; margin-top: 20px;"> <p>Manual soldering (Solder iron)</p>  </div> <div style="margin-top: 20px;"> <p><u>APPLICATION</u></p> <p>As for CGA4 (CC0805) and CGA5 (CC1206), applied to wave soldering and reflow soldering.</p> <p>As for CGA6 (CC1210), CGA8 (CC1812), CGA9 (CC2220), applied only to reflow soldering.</p> </div> <p>5-3. Recommended soldering peak temp and peak temp duration</p> <table border="1" style="width: 100%; border-collapse: collapse;"> <thead> <tr> <th rowspan="2" style="text-align: center;">Temp./Duration</th> <th colspan="2" style="text-align: center;">Wave soldering</th> <th colspan="2" style="text-align: center;">Reflow soldering</th> </tr> <tr> <th style="text-align: center;">Peak temp(°C)</th> <th style="text-align: center;">Duration(sec.)</th> <th style="text-align: center;">Peak temp(°C)</th> <th style="text-align: center;">Duration(sec.)</th> </tr> </thead> <tbody> <tr> <td style="text-align: center;">Solder</td> <td></td> <td></td> <td></td> <td></td> </tr> <tr> <td style="text-align: center;">Sn-Pb Solder</td> <td style="text-align: center;">250 max.</td> <td style="text-align: center;">3 max.</td> <td style="text-align: center;">230 max.</td> <td style="text-align: center;">20 max.</td> </tr> <tr> <td style="text-align: center;">Lead Free Solder</td> <td style="text-align: center;">260 max.</td> <td style="text-align: center;">5 max.</td> <td style="text-align: center;">260 max.</td> <td style="text-align: center;">10 max.</td> </tr> </tbody> </table> <p>Recommended solder compositions</p> <p>Sn-37Pb (Sn-Pb solder)</p> <p>Sn-3.0Ag-0.5Cu (Lead Free Solder)</p>	Temp./Duration	Wave soldering		Reflow soldering		Peak temp(°C)	Duration(sec.)	Peak temp(°C)	Duration(sec.)	Solder					Sn-Pb Solder	250 max.	3 max.	230 max.	20 max.	Lead Free Solder	260 max.	5 max.	260 max.	10 max.
Temp./Duration	Wave soldering			Reflow soldering																						
	Peak temp(°C)	Duration(sec.)	Peak temp(°C)	Duration(sec.)																						
Solder																										
Sn-Pb Solder	250 max.	3 max.	230 max.	20 max.																						
Lead Free Solder	260 max.	5 max.	260 max.	10 max.																						

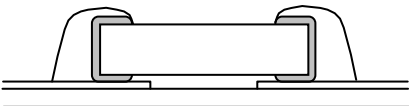
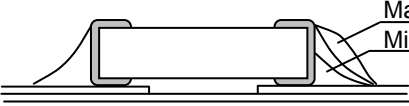
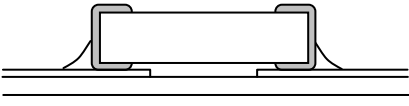
No.	Process	Condition																								
5	Soldering	<p>5-4. Avoiding thermal shock</p> <p>1) Preheating condition</p> <table border="1" data-bbox="552 264 1426 607"> <thead> <tr> <th>Soldering</th> <th>Type</th> <th>Temp. (°C)</th> </tr> </thead> <tbody> <tr> <td>Wave soldering</td> <td>CGA4(CC0805), CGA5(CC1206)</td> <td>$\Delta T \leq 150$</td> </tr> <tr> <td rowspan="2">Reflow soldering</td> <td>CGA4(CC0805), CGA5(CC1206)</td> <td>$\Delta T \leq 150$</td> </tr> <tr> <td>CGA6(CC1210), CGA8(CC1812), CGA9(CC2220)</td> <td>$\Delta T \leq 130$</td> </tr> <tr> <td rowspan="2">Manual soldering</td> <td>CGA4(CC0805), CGA5(CC1206)</td> <td>$\Delta T \leq 150$</td> </tr> <tr> <td>CGA6(CC1210), CGA8(CC1812), CGA9(CC2220)</td> <td>$\Delta T \leq 130$</td> </tr> </tbody> </table> <p>2) Cooling condition Natural cooling using air is recommended. If the chips are dipped into a solvent for cleaning, the temperature difference (ΔT) must be less than 100°C.</p> <p>5-5. Amount of solder</p> <p>Excessive solder will induce higher tensile force in chip capacitors when temperature changes and it may result in chip cracking. In sufficient solder may detach the capacitors from the P.C.board.</p> <div style="display: flex; justify-content: space-between; align-items: flex-start;"> <div style="width: 30%;">Excessive solder</div> <div style="width: 30%; text-align: center;">  </div> <div style="width: 30%;">Higher tensile force in chip capacitors to cause crack</div> </div> <hr/> <div style="display: flex; justify-content: space-between; align-items: center;"> <div style="width: 30%;">Adequate</div> <div style="width: 30%; text-align: center;">  </div> </div> <hr/> <div style="display: flex; justify-content: space-between; align-items: flex-start;"> <div style="width: 30%;">Insufficient solder</div> <div style="width: 30%; text-align: center;">  </div> <div style="width: 30%;">Low robustness may cause contact failure or chip capacitors come off the P.C.board.</div> </div> <hr/> <p>5-6. Solder repair by solder iron</p> <p>1) Selection of the soldering iron tip</p> <p>Tip temperature of solder iron varies by its type, P.C.board material and solder land size. The higher the tip temperature, the quicker the operation. However, heat shock may cause a crack in the chip capacitors. Please make sure the tip temp. before soldering and keep the peak temp and time in accordance with following recommended condition. (Please preheat the chip capacitors with the condition in 5-4 to avoid the thermal shock.)</p> <p>Recommended solder iron condition (Sn-Pb Solder and Lead Free Solder)</p> <table border="1" data-bbox="552 1809 1390 1915"> <thead> <tr> <th>Temp. (°C)</th> <th>Duration (sec.)</th> <th>Wattage (W)</th> <th>Shape (mm)</th> </tr> </thead> <tbody> <tr> <td>300 max.</td> <td>3 max.</td> <td>20 max.</td> <td>Ø 3.0 max.</td> </tr> </tbody> </table>	Soldering	Type	Temp. (°C)	Wave soldering	CGA4(CC0805), CGA5(CC1206)	$\Delta T \leq 150$	Reflow soldering	CGA4(CC0805), CGA5(CC1206)	$\Delta T \leq 150$	CGA6(CC1210), CGA8(CC1812), CGA9(CC2220)	$\Delta T \leq 130$	Manual soldering	CGA4(CC0805), CGA5(CC1206)	$\Delta T \leq 150$	CGA6(CC1210), CGA8(CC1812), CGA9(CC2220)	$\Delta T \leq 130$	Temp. (°C)	Duration (sec.)	Wattage (W)	Shape (mm)	300 max.	3 max.	20 max.	Ø 3.0 max.
Soldering	Type	Temp. (°C)																								
Wave soldering	CGA4(CC0805), CGA5(CC1206)	$\Delta T \leq 150$																								
Reflow soldering	CGA4(CC0805), CGA5(CC1206)	$\Delta T \leq 150$																								
	CGA6(CC1210), CGA8(CC1812), CGA9(CC2220)	$\Delta T \leq 130$																								
Manual soldering	CGA4(CC0805), CGA5(CC1206)	$\Delta T \leq 150$																								
	CGA6(CC1210), CGA8(CC1812), CGA9(CC2220)	$\Delta T \leq 130$																								
Temp. (°C)	Duration (sec.)	Wattage (W)	Shape (mm)																							
300 max.	3 max.	20 max.	Ø 3.0 max.																							

No.	Process	Condition
5	Soldering	<p>2) Direct contact of the soldering iron with ceramic dielectric of chip capacitors may cause crack. Do not touch the ceramic dielectric and the terminations by solder iron.</p> <p>5-7. Sn-Zn solder Sn-Zn solder affects product reliability. Please contact TDK in advance when utilize Sn-Zn solder.</p> <p>5-8. Countermeasure for tombstone The misalignment between the mounted positions of the capacitors and the land patterns should be minimized. The tombstone phenomenon may occur especially the capacitors are mounted (in longitudinal direction) in the same direction of the reflow soldering. (Refer to JEITA RCR-2335B Annex 1 (Informative) Recommendations to prevent the tombstone phenomenon)</p>
6	Cleaning	<p>1) If an unsuitable cleaning fluid is used, flux residue or some foreign articles may stick to chip capacitors surface to deteriorate especially the insulation resistance.</p> <p>2) If cleaning condition is not suitable, it may damage the chip capacitors.</p> <p>2)-1. Insufficient washing</p> <p>(1) Terminal electrodes may corrode by Halogen in the flux.</p> <p>(2) Halogen in the flux may adhere on the surface of capacitors, and lower the insulation resistance.</p> <p>(3) Water soluble flux has higher tendency to have above mentioned problems (1) and (2).</p> <p>2)-2. Excessive washing</p> <p>When ultrasonic cleaning is used, excessively high ultrasonic energy output can affect the connection between the ceramic chip capacitor's body and the terminal electrode. To avoid this, following is the recommended condition.</p> <p style="text-align: center;">Power : 20 W/l max. Frequency : 40 kHz max. Washing time : 5 minutes max.</p> <p>2)-3. If the cleaning fluid is contaminated, density of Halogen increases, and it may bring the same result as insufficient cleaning.</p>

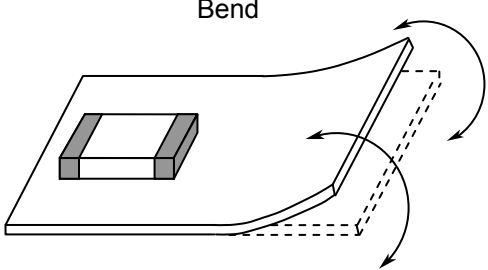
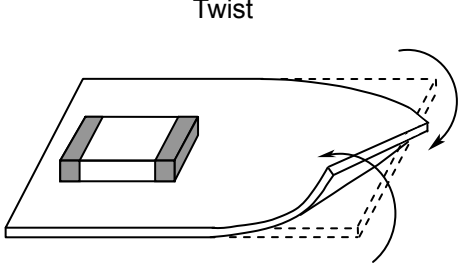
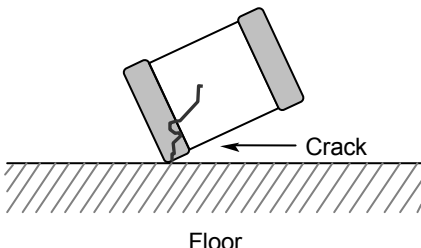
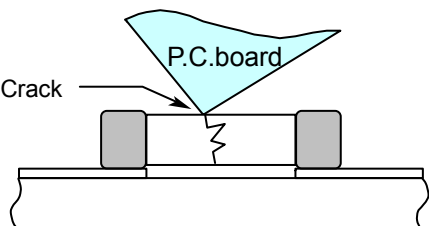
No.	Process	Condition						
7	Coating and molding of the P.C.board	<p>1) When the P.C.board is coated, please verify the quality influence on the product.</p> <p>2) Please verify carefully that there is no harmful decomposing or reaction gas emission during curing which may damage the chip capacitors.</p> <p>3) Please verify the curing temperature.</p>						
8	Handling after chip mounted ⚠ Caution	<p>1) Please pay attention not to bend or distort the P.C.board after soldering in handling otherwise the chip capacitors may crack.</p> <div style="display: flex; justify-content: space-around; align-items: center;"> <div style="text-align: center;"> <p>Bend</p>  </div> <div style="text-align: center;"> <p>Twist</p>  </div> </div> <p>2) When functional check of the P.C.board is performed, check pin pressure tends to be adjusted higher for fear of loose contact. But if the pressure is excessive and bend the P.C.board, it may crack the chip capacitors or peel the terminations off. Please adjust the check pins not to bend the P.C.board.</p> <table border="1" style="width: 100%; border-collapse: collapse;"> <thead> <tr> <th data-bbox="488 981 628 1043">Item</th> <th data-bbox="628 981 1046 1043">Not recommended</th> <th data-bbox="1046 981 1445 1043">Recommended</th> </tr> </thead> <tbody> <tr> <td data-bbox="488 1043 628 1285" style="text-align: center; vertical-align: middle;">Board bending</td> <td data-bbox="628 1043 1046 1285" style="text-align: center;">  </td> <td data-bbox="1046 1043 1445 1285" style="text-align: center;">  </td> </tr> </tbody> </table>	Item	Not recommended	Recommended	Board bending		
Item	Not recommended	Recommended						
Board bending								
9	Handling of loose chip capacitors	<p>1) If dropped the chip capacitors may crack. Once dropped do not use it. Especially, the large case sized chip capacitors are tendency to have cracks easily, so please handle with care.</p> <div style="text-align: center;">  </div> <p>2) Piling the P.C.board after mounting for storage or handling, the corner of the P.C. board may hit the chip capacitors of another board to cause crack.</p> <div style="text-align: center;">  </div>						

No.	Process	Condition
10	Capacitance aging	The capacitors (Class 2) have aging in the capacitance. They may not be used in precision time constant circuit. In case of the time constant circuit, the evaluation should be done well.
11	Estimated life and estimated failure rate of capacitors	As per the estimated life and the estimated failure rate depend on the temperature and the voltage. This can be calculated by the equation described in JEITA RCR-2335B Annex 6 (Informative) Calculation of the estimated lifetime and the estimated failure rate (Voltage acceleration coefficient : 3 multiplication rule, Temperature acceleration coefficient : 10°C rule) The failure rate can be decreased by reducing the temperature and the voltage but they will not be guaranteed.
12	Others △ Caution	<p>The products listed on this specification sheet are intended for use in general electronic equipment (AV equipment, telecommunications equipment, home appliances, amusement equipment, computer equipment, personal equipment, office equipment, measurement equipment, industrial robots) under a normal operation and use condition.</p> <p>The products are not designed or warranted to meet the requirements of the applications listed below, whose performance and/or quality require a more stringent level of safety or reliability, or whose failure, malfunction or trouble could cause serious damage to society, person or property. Please understand that we are not responsible for any damage or liability caused by use of the products in any of the applications below or for any other use exceeding the range or conditions set forth in this specification sheet. If you intend to use the products in the applications listed below or if you have special requirements exceeding the range or conditions set forth in this specification, please contact us.</p> <p>(1) Aerospace/Aviation equipment (2) Transportation equipment (cars, electric trains, ships, etc.) (3) Medical equipment (4) Power-generation control equipment (5) Atomic energy-related equipment (6) Seabed equipment (7) Transportation control equipment (8) Public information-processing equipment (9) Military equipment (10) Electric heating apparatus, burning equipment (11) Disaster prevention/crime prevention equipment (12) Safety equipment (13) Other applications that are not considered general-purpose applications</p> <p>When designing your equipment even for general-purpose applications, you are kindly requested to take into consideration securing protection circuit/device or providing backup circuits in your equipment.</p>

13. Packaging label

Packaging shall be done to protect the components from the damage during transportation and storing, and a label which has the following information shall be attached.

- 1) Inspection No.
- 2) TDK P/N
- 3) Customer's P/N
- 4) Quantity

*Composition of Inspection No.

Example F 2 A - 00 - 000
 (a) (b) (c) (d) (e)

- a) Line code
- b) Last digit of the year
- c) Month and A for January and B for February and so on. (Skip I)
- d) Inspection Date of the month.
- e) Serial No. of the day

14. Bulk packaging quantity

Total number of components in a plastic bag for bulk packaging : 1,000pcs.

15. TAPE PACKAGING SPECIFICATION

1. CONSTRUCTION AND DIMENSION OF TAPING

1-1. Dimensions of carrier tape

Dimensions of paper tape shall be according to Appendix 3.
 Dimensions of plastic tape shall be according to Appendix 4, 5.

1-2. Bulk part and leader of taping

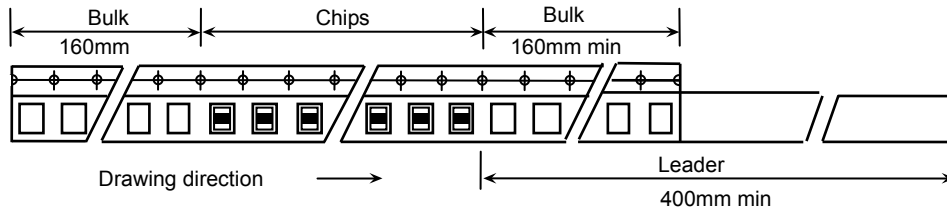

1-3. Dimensions of reel

Dimensions of $\varnothing 178$ reel shall be according to Appendix 6, 7.
 Dimensions of $\varnothing 330$ reel shall be according to Appendix 8, 9.

1-4. Structure of taping

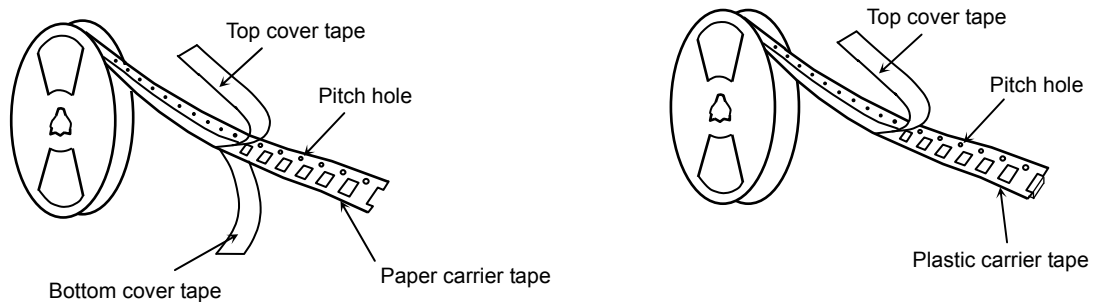

2. CHIP QUANTITY

Type	Thickness of chip	Taping Material	Chip quantity(pcs.)		
			$\varnothing 178$ mm reel	$\varnothing 330$ mm reel	
CGA4 (CC0805)	0.85 mm	Paper	4,000	10,000	
	1.25 mm	Plastic	2,000		
CGA5 (CC1206)	1.15 mm	Plastic	2,000	10,000	
	1.30 mm			8,000	
	1.60 mm				
CGA6 (CC1210)	1.60 mm	Plastic	2,000	8,000	
	2.00 mm				
	2.30 mm				5,000
	2.50 mm				
CGA8 (CC1812)	2.00 mm	Plastic	1,000	3,000	
	2.30 mm		500		
	2.50 mm				
CGA9 (CC2220)	2.30 mm	Plastic	500	3,000	
	2.50 mm				

3. PERFORMANCE SPECIFICATIONS

- 3-1. Fixing peeling strength (top tape)
0.05-0.7N. (See the following figure.)

TYPE 1 (Paper)

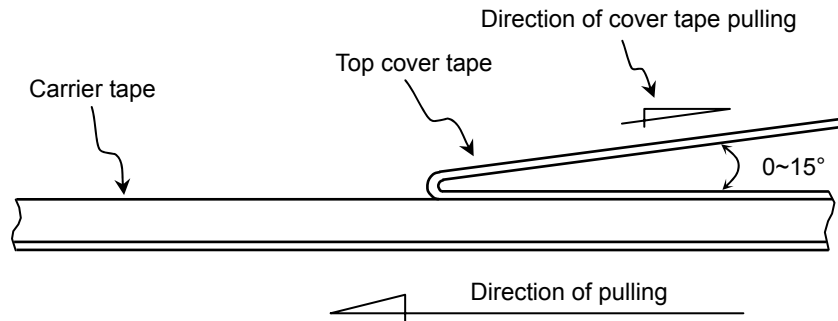

TYPE 2 (Plastic)

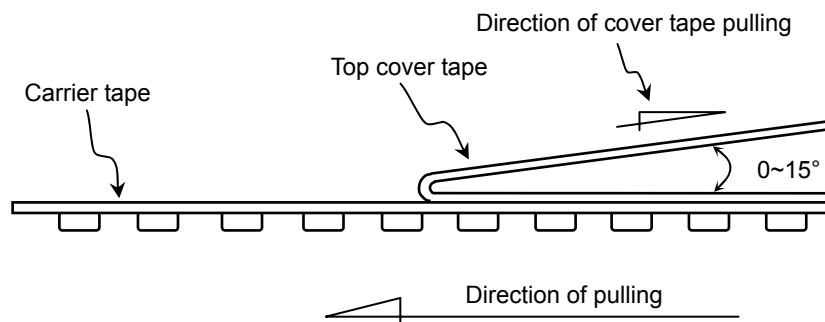

- 3-2. Carrier tape shall be flexible enough to be wound around a minimum radius of 30mm with components in tape.
- 3-3. The missing of components shall be less than 0.1%
- 3-4. Components shall not stick to fixing tape.
- 3-5. The fixing tapes shall not protrude beyond the edges of the carrier tape
not shall cover the sprocket holes.

Appendix 3

Paper Tape

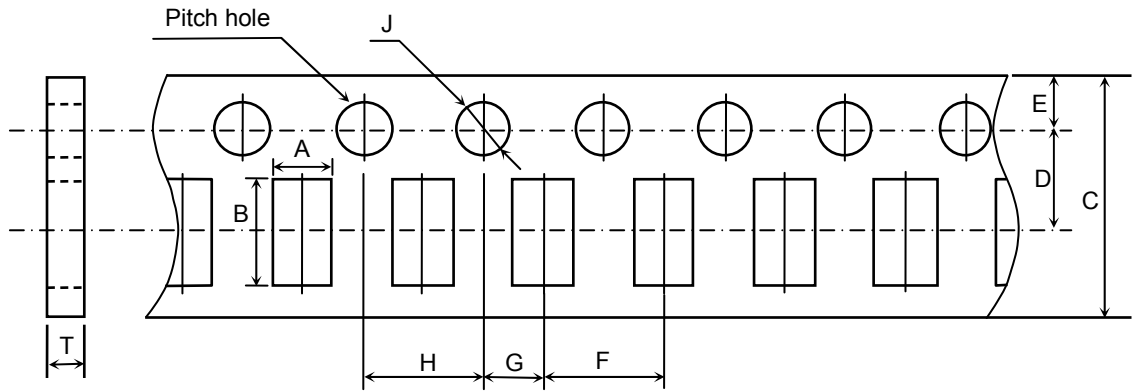

(Unit : mm)

Symbol Type	A	B	C	D	E	F
CGA4 (CC0805)	(1.50)	(2.30)	8.00 ± 0.30	3.50 ± 0.05	1.75 ± 0.10	4.00 ± 0.10
Symbol Type	G	H	J	T		
CGA4 (CC0805)	2.00 ± 0.05	4.00 ± 0.10	$\varnothing 1.5 \begin{matrix} +0.10 \\ 0 \end{matrix}$	1.10 max.		

* The values in the parentheses () are for reference.

Appendix 4

Plastic Tape

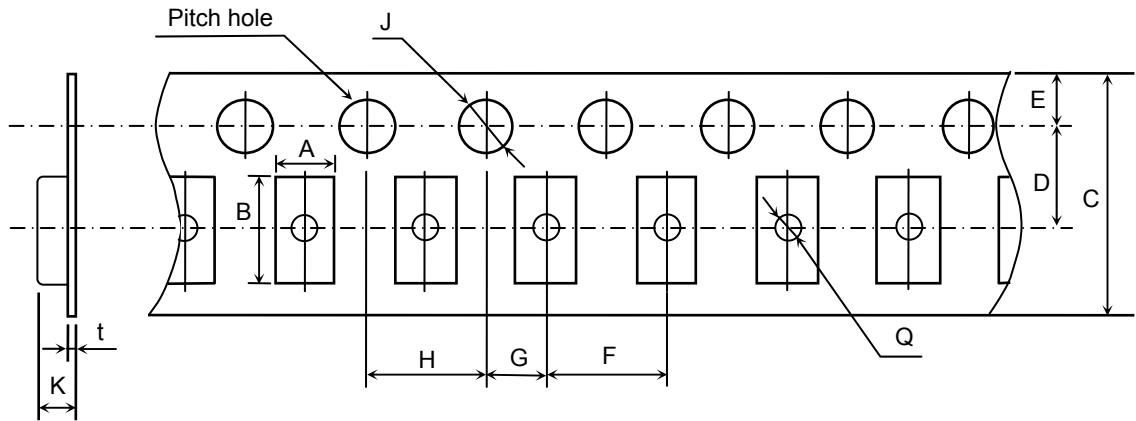

(Unit : mm)

Symbol Type	A	B	C	D	E	F
CGA4 (CC0805)	(1.50)	(2.30)	8.00 ± 0.30	3.50 ± 0.05	1.75 ± 0.10	4.00 ± 0.10
CGA5 (CC1206)	(1.90)	(3.50)				
CGA6 (CC1210)	(2.90)	(3.60)	8.00 ± 0.30 or 12.0 ± 0.30	3.50 ± 0.05 or 5.50 ± 0.05		
Symbol Type	G	H	J	K	t	Q
CGA4 (CC0805)	2.00 ± 0.05	4.00 ± 0.10	∅ 1.5 ^{+0.10} ₀	2.50 max.	0.60 max.	∅ 0.50 min.
CGA5 (CC1206)				3.20 max.		
CGA6 (CC1210)						

* The values in the parentheses () are for reference.

* Exceptionally no hole in the cavity is applied. Please inquire if hole in cavity is mandatory.

Appendix 5

Plastic Tape

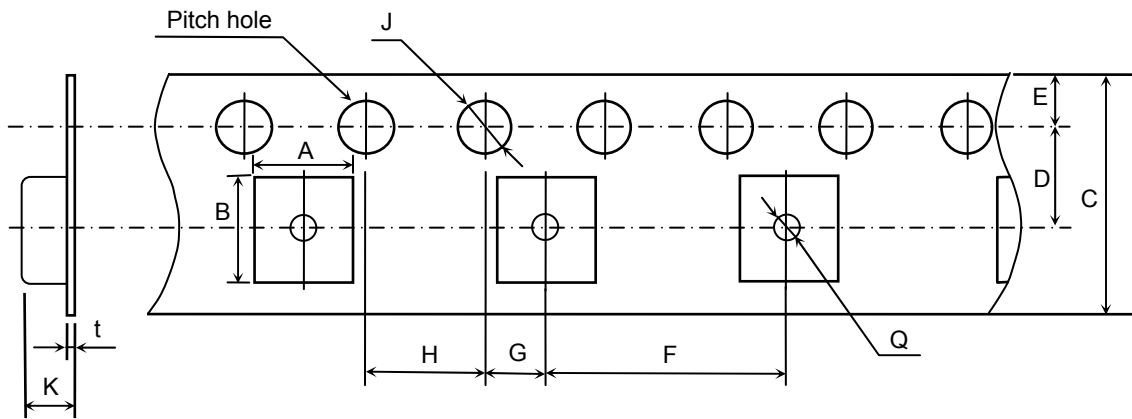

(Unit : mm)

Symbol Type	A	B	C	D	E	F
CGA8 (CC1812)	(3.60)	(4.90)	12.0 ± 0.30	5.50 ± 0.05	1.75 ± 0.10	8.00 ± 0.10
CGA9 (CC2220)	(5.70)	(6.40)				
Symbol Type	G	H	J	K	t	Q
CGA8 (CC1812)	2.00 ± 0.05	4.00 ± 0.10	$\varnothing 1.5 \begin{matrix} +0.10 \\ 0 \end{matrix}$	6.50 max.	0.60 max.	$\varnothing 1.50$ min.
CGA9 (CC2220)						

* The values in the parentheses () are for reference.

Appendix 6

CGA4, CGA5, CGA6

(Material : Polystyrene)

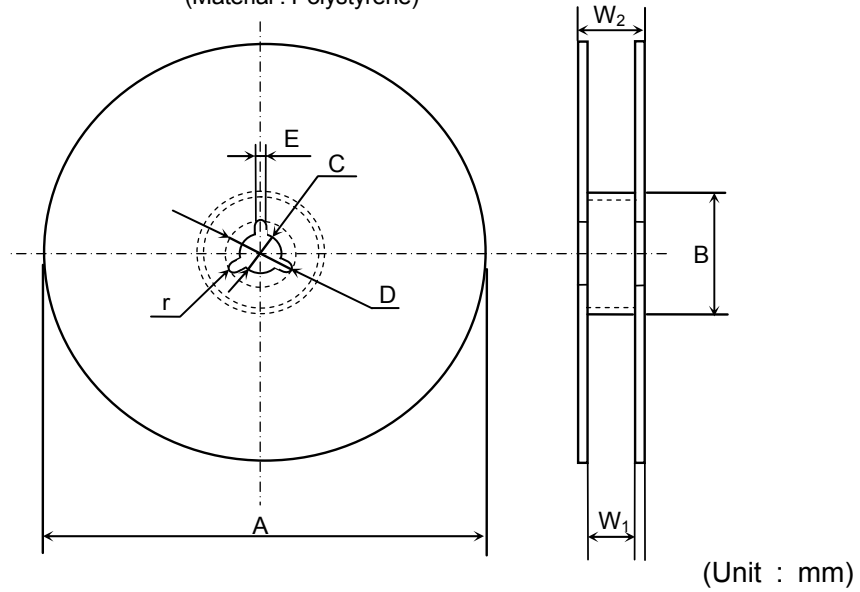

Symbol	A	B	C	D	E	W ₁
Dimension	Ø178 ± 2.0	Ø60 ± 2.0	Ø13 ± 0.5	Ø21 ± 0.8	2.0 ± 0.5	9.0 ± 0.3
Symbol	W ₂	r				
Dimension	13.0 ± 1.4	1.0				

Appendix 7

CGA6 12mm width taping type, CGA8, CGA9

(Material : Polystyrene)

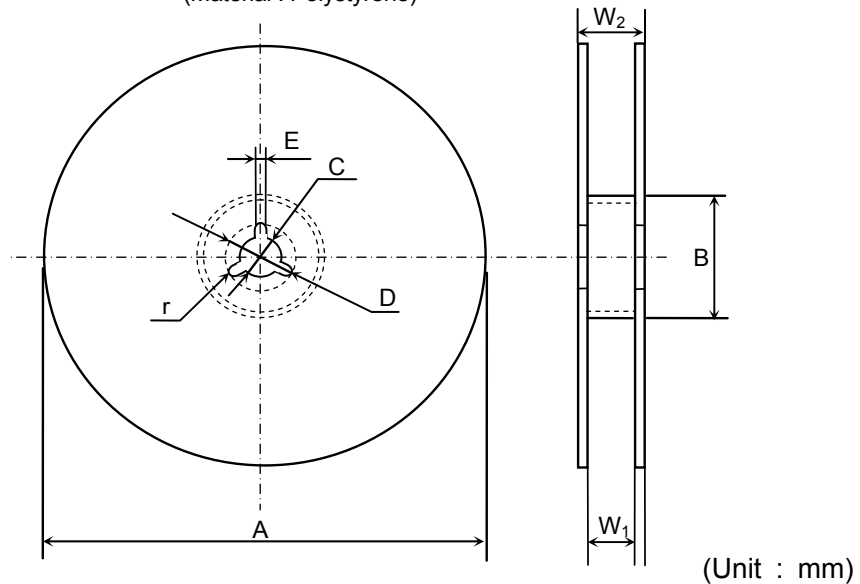

Symbol	A	B	C	D	E	W ₁
Dimension	Ø178 ± 2.0	Ø60 ± 2.0	Ø13 ± 0.5	Ø21 ± 0.8	2.0 ± 0.5	13.0 ± 0.3
Symbol	W ₂	r				
Dimension	17.0 ± 1.4	1.0				

Appendix 8

CGA4, CGA5, CGA6

(Material : Polystyrene)

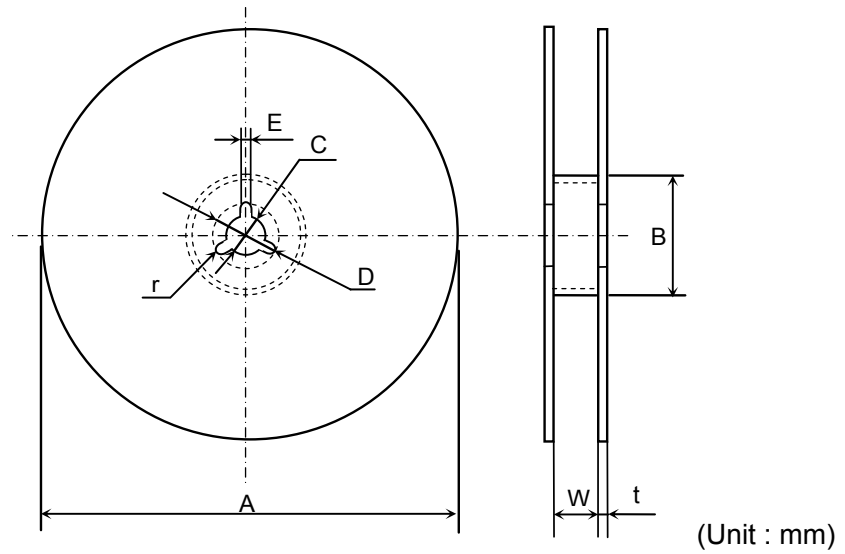

Symbol	A	B	C	D	E	W
Dimension	Ø382 max. (Nominal Ø330)	Ø50 min.	Ø13 ± 0.5	Ø21 ± 0.8	2.0 ± 0.5	10.0 ± 1.5
Symbol	t	r				
Dimension	2.0 ± 0.5	1.0				

Appendix 9

CGA6 12mm width taping type, CGA8, CGA9

(Material : Polystyrene)

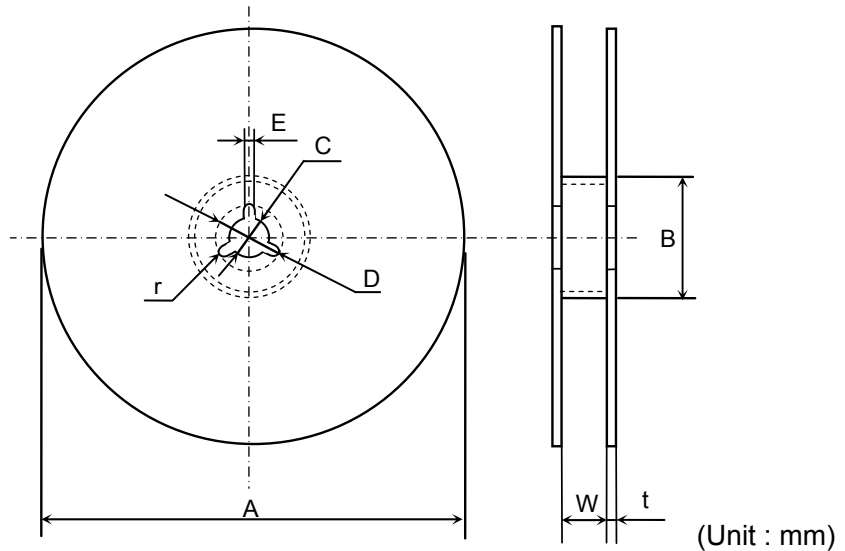

Symbol	A	B	C	D	E	W
Dimension	Ø382 max. (Nominal Ø330)	Ø50 min.	Ø13 ± 0.5	Ø21 ± 0.8	2.0 ± 0.5	14.0 ± 1.5
Symbol	t	r				
Dimension	2.0 ± 0.5	1.0				