



Common Mode Filters

For high-speed differential signal line
(USB2.0, LVDS, etc.)

MCZ-AH series

MCZ0806AH	[0302 inch]*
MCZ1210AH	[0504 inch]
MCZ2010AH	[0804 inch]

* Dimensions Code JIS[EIA]

REMINDERS FOR USING THESE PRODUCTS

Before using these products, be sure to request the delivery specifications.

SAFETY REMINDERS

Please pay sufficient attention to the warnings for safe designing when using these products.

REMINDERS

- The storage period is less than 12 months. Be sure to follow the storage conditions (Temperature: 5 to 40°C, Humidity: 10 to 75% RH or less).
If the storage period elapses, the soldering of the terminal electrodes may deteriorate.
- Do not use or store in locations where there are conditions such as gas corrosion (salt, acid, alkali, etc.).
- Before soldering, be sure to preheat components.
The preheating temperature should be set so that the temperature difference between the solder temperature and chip temperature does not exceed 150°C.
- Soldering corrections after mounting should be within the range of the conditions determined in the specifications.
If overheated, a short circuit, performance deterioration, or lifespan shortening may occur.
- When embedding a printed circuit board where a chip is mounted to a set, be sure that residual stress is not given to the chip due to the overall distortion of the printed circuit board and partial distortion such as at screw tightening portions.
- Self heating (temperature increase) occurs when the power is turned ON, so the tolerance should be sufficient for the set thermal design.
- Carefully lay out the coil for the circuit board design of the non-magnetic shield type.
A malfunction may occur due to magnetic interference.
- Use a wrist band to discharge static electricity in your body through the grounding wire.
- Do not expose the products to magnets or magnetic fields.
- Do not use for a purpose outside of the contents regulated in the delivery specifications.
- The products listed on this catalog are intended for use in general electronic equipment (AV equipment, telecommunications equipment, home appliances, amusement equipment, computer equipment, personal equipment, office equipment, measurement equipment, industrial robots) under a normal operation and use condition.
The products are not designed or warranted to meet the requirements of the applications listed below, whose performance and/or quality require a more stringent level of safety or reliability, or whose failure, malfunction or trouble could cause serious damage to society, person or property.
If you intend to use the products in the applications listed below or if you have special requirements exceeding the range or conditions set forth in the each catalog, please contact us.

- (1) Aerospace/Aviation equipment
- (2) Transportation equipment (cars, electric trains, ships, etc.)
- (3) Medical equipment
- (4) Power-generation control equipment
- (5) Atomic energy-related equipment
- (6) Seabed equipment
- (7) Transportation control equipment

- (8) Public information-processing equipment
- (9) Military equipment
- (10) Electric heating apparatus, burning equipment
- (11) Disaster prevention/crime prevention equipment
- (12) Safety equipment
- (13) Other applications that are not considered general-purpose applications

When designing your equipment even for general-purpose applications, you are kindly requested to take into consideration securing protection circuit/device or providing backup circuits in your equipment.

Common Mode Filters

For high-speed differential signal line
(USB2.0, LVDS, etc.)

Product compatible with RoHS directive
Halogen-free
Compatible with lead-free solders

Overview of the MCZ-AH Series

FEATURES

- Compact multilayer common mode filter.
- Has EMC suppression by achieving wide frequency range differential mode transmission while ensuring common mode impedance with virtually no affect on the high-speed differential transmission line signal.

APPLICATION

- Electronic equipment high-speed interface (LVDS, USB2.0, MHL)
- Mobile phones, PCs, DSCs, portable game machines, etc.
- PDP/LCD/DLP/PJ TVs, DVD players, DVCs, mobile audio, etc.

PART NUMBER CONSTRUCTION

MCZ	1210		AH	360		L2		T
Series name	LxWxT Dimensions (mm)		Product internal code	Impedance (Ω) at 100MHz		Number of lines		Packaging style
	0806	0.85×0.65×0.45	AH	360	36	L2	2 lines	T
	1210	1.25×1.0×0.5				L4	4 lines	Taping
	2010	2.0×1.0×0.5						

OPERATING TEMPERATURE RANGE, PACKAGE QUANTITY, PRODUCT WEIGHT

Type	Temperature range		Package quantity	Individual weight
	Operating temperature	Storage temperature*		
	(°C)	(°C)	(pieces/reel)	(mg)
MCZ0806AH	-40 to +85	-40 to +85	10,000	1.4
MCZ1210AH	-40 to +85	-40 to +85	4,000	3.0
MCZ2010AH	-40 to +85	-40 to +85	5,000	5.0

* The Storage temperature range is for after the circuit board is mounted.

- RoHS Directive Compliant Product: See the following for more details related to RoHS Directive compliant products. <http://www.tdk.co.jp/rohs/>
- Halogen-free: Indicates that Cl content is less than 900ppm, Br content is less than 900ppm, and that the total Cl and Br content is less than 1500ppm.

• All specifications are subject to change without notice.

Overview of the MCZ-AH Series

RECOMMENDED REFLOW PROFILE



Preheating			Soldering		Peak	
Temp.	Temp.	Time	Temp.	Time	Temp.	Time
T1	T2	t1	T3	t2	T4	t3
150°C	180°C	60 to 120s	230°C	30 to 60s	250 to 260°C	10s max.

MCZ-AH series

MCZ0806AH Type



SHAPE & DIMENSIONS

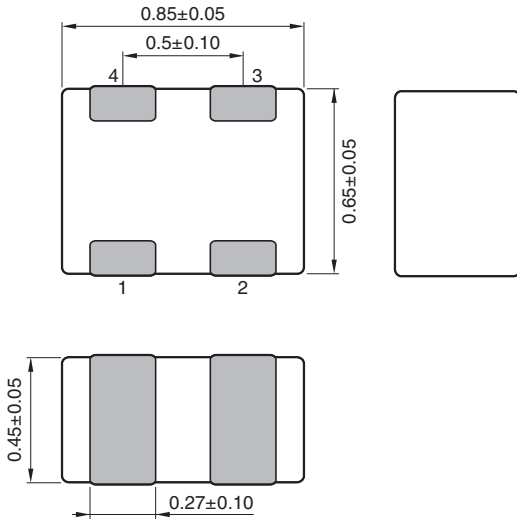

Dimensions in mm

RECOMMENDED LAND PATTERN

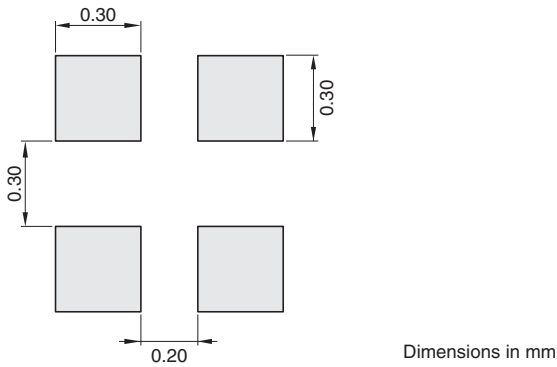

CIRCUIT DIAGRAM

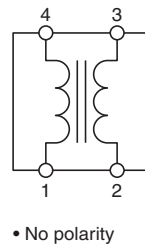

• No polarity

• All specifications are subject to change without notice.

MCZ-AH series MCZ0806AH Type

ELECTRICAL CHARACTERISTICS

CHARACTERISTICS SPECIFICATION TABLE

Common mode impedance [100MHz] (Ω)	Tolerance	DC resistance (Ω)max. [1 line]	Rated current (mA)max.	Rated voltage (V)max.	Insulation resistance (M Ω)min.	Part No.
22	$\pm 8\Omega$	1.5	100	5	10	MCZ0806AH220L2T
35	$\pm 25\%$	2.5	100	5	10	MCZ0806AH350L2T
50	$\pm 25\%$	3.0	100	5	10	MCZ0806AH500L2T
90	$\pm 25\%$	4.0	100	5	10	MCZ0806AH900L2T

Measurement equipment

Measurement item	Product No.	Manufacturer
Common mode impedance	E4991A+16192A	Agilent Technologies
DC resistance	Type-7561	Yokogawa
Insulation resistance	4339B	Agilent Technologies

* Equivalent measurement equipment may be used.

IMPEDANCE VS. FREQUENCY CHARACTERISTICS

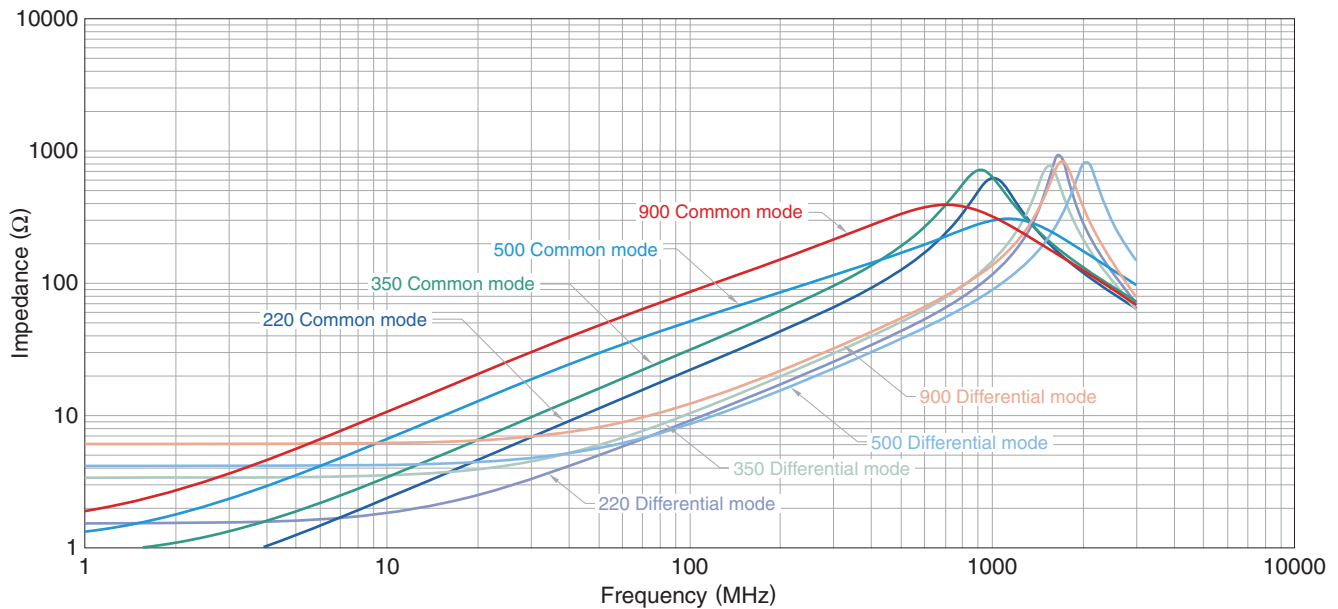

Measurement equipment

Product No.	Manufacturer
E4991A+16192A	Agilent Technologies

* Equivalent measurement equipment may be used.

MCZ-AH series

MCZ1210AH Type



SHAPE & DIMENSIONS

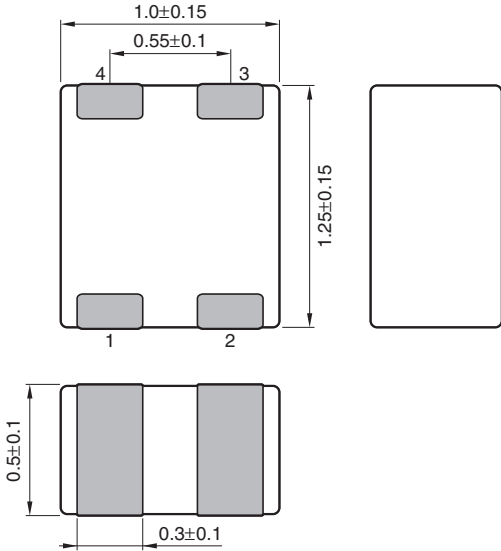

Dimensions in mm

RECOMMENDED LAND PATTERN

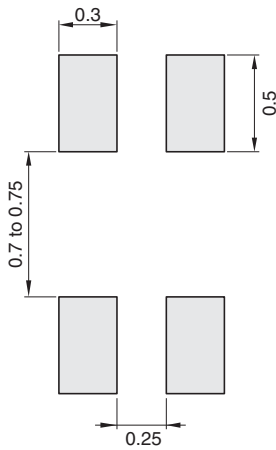

Dimensions in mm

CIRCUIT DIAGRAM

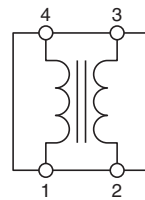

• No polarity

• All specifications are subject to change without notice.

MCZ-AH series MCZ1210AH Type

ELECTRICAL CHARACTERISTICS

CHARACTERISTICS SPECIFICATION TABLE

Common mode impedance [100MHz] (Ω)	Tolerance	DC resistance (Ω)max. [1 line]	Rated current (mA)max.	Rated voltage (V)max.	Insulation resistance (M Ω)min.	Part No.
36	$\pm 25\%$	1.00	200	5	10	MCZ1210AH360L2T
90	$\pm 25\%$	1.75	100	5	10	MCZ1210AH900L2T
200	$\pm 25\%$	4.00	100	5	10	MCZ1210AH201L2T
300	$\pm 25\%$	4.50	100	5	10	MCZ1210AH301L2T

Measurement equipment

Measurement item	Product No.	Manufacturer
Common mode impedance	E4991A+16192A	Agilent Technologies
DC resistance	Type-7561	Yokogawa
Insulation resistance	4339B	Agilent Technologies

* Equivalent measurement equipment may be used.

IMPEDANCE VS. FREQUENCY CHARACTERISTICS

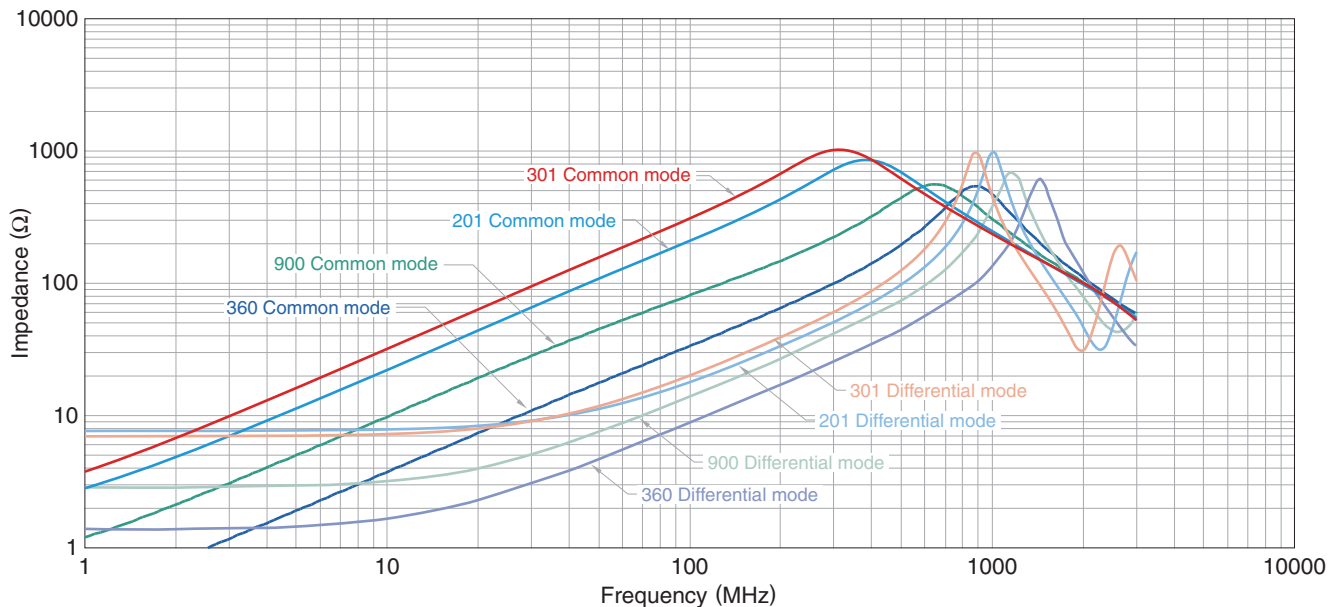

Measurement equipment

Product No.	Manufacturer
E4991A+16192A	Agilent Technologies

* Equivalent measurement equipment may be used.

MCZ-AH series

MCZ2010AH Type



SHAPE & DIMENSIONS

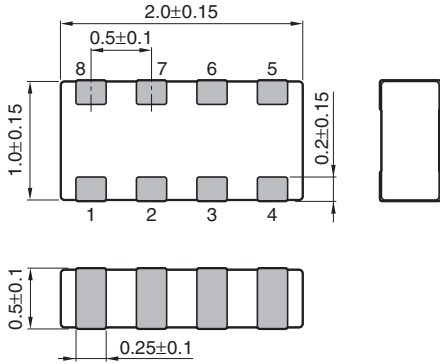

Dimensions in mm

RECOMMENDED LAND PATTERN

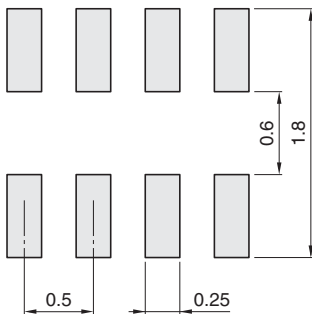

Dimensions in mm

CIRCUIT DIAGRAM

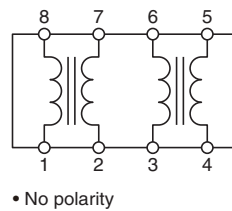

• No polarity

MCZ-AH series MCZ2010AH Type

ELECTRICAL CHARACTERISTICS

CHARACTERISTICS SPECIFICATION TABLE

Common mode impedance [100MHz] (Ω)	Tolerance	DC resistance (Ω)max. [1 line]	Rated current (mA)max.	Rated voltage (V)max.	Insulation resistance (M Ω)min.	Part No.
90	$\pm 25\%$	1.50	100	5	10	MCZ2010AH900L4T
120	$\pm 25\%$	2.00	100	5	10	MCZ2010AH121L4T
200	$\pm 25\%$	3.50	100	5	10	MCZ2010AH201L4T

Measurement equipment

Measurement item	Product No.	Manufacturer
Common mode impedance	E4991A+16192A	Agilent Technologies
DC resistance	Type-7561	Yokogawa
Insulation resistance	4339B	Agilent Technologies

* Equivalent measurement equipment may be used.

IMPEDANCE VS. FREQUENCY CHARACTERISTICS

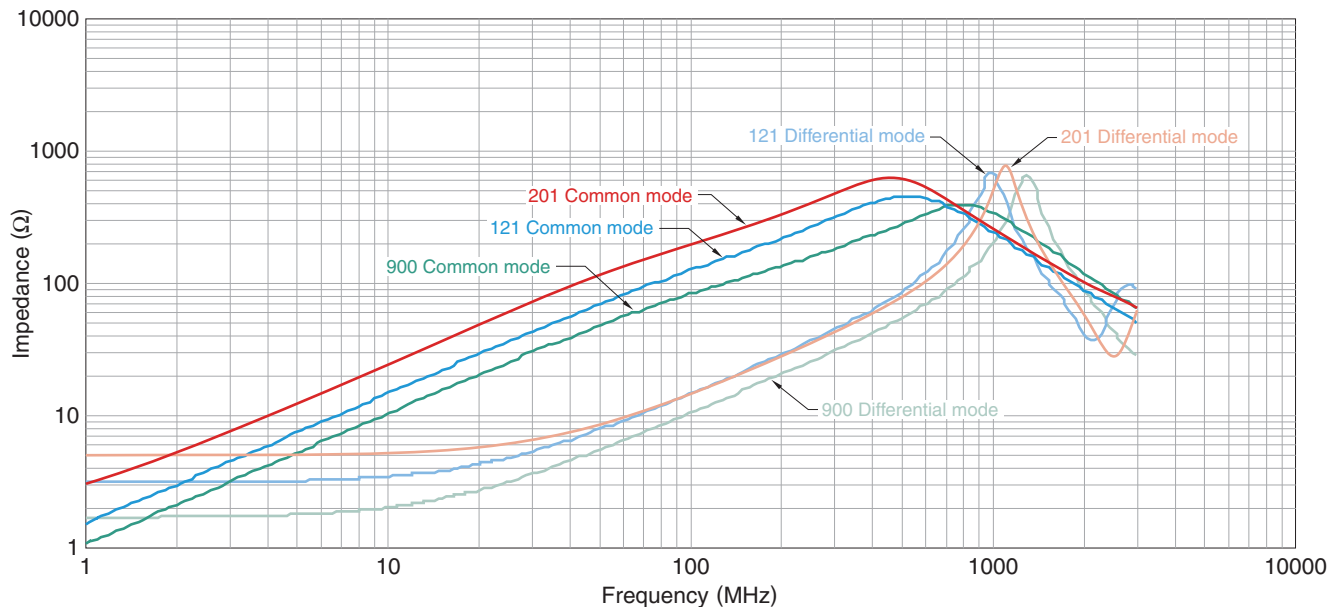

Measurement equipment

Product No.	Manufacturer
E4991A+16192A	Agilent Technologies

* Equivalent measurement equipment may be used.

MCZ-AH series

Packaging style

REEL DIMENSIONS

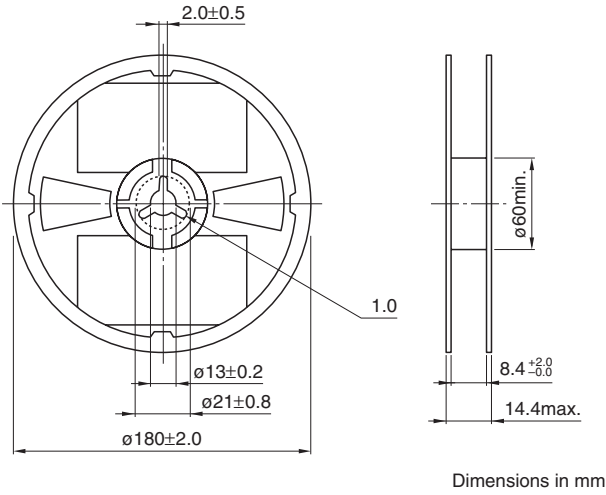

Dimensions in mm

TAPE DIMENSIONS

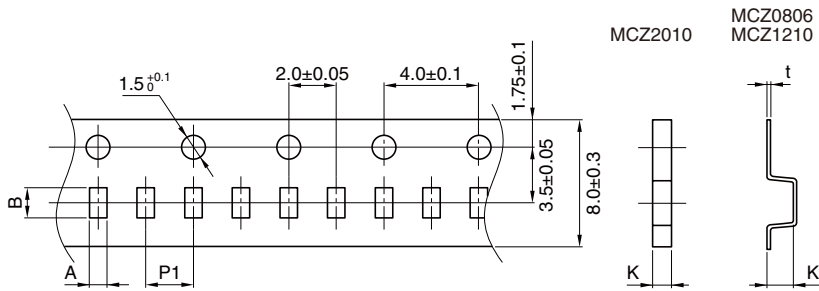

Dimensions in mm

Type	A	B	P1	K	t
MCZ0806AH	0.75±0.05	0.95±0.05	2.0±0.05	0.6max.	0.25±0.05
MCZ1210AH	1.15±0.1	1.4±0.1	4.0±0.1	1.0max.	0.25±0.05
MCZ2010AH	1.15±0.05	2.15±0.05	4.0±0.1	0.86max.	—

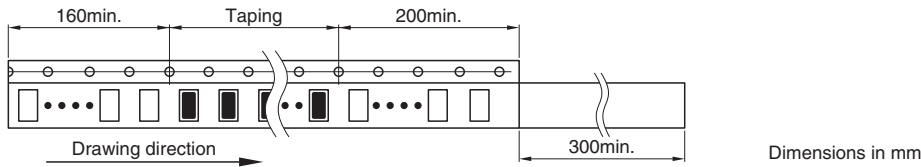

Dimensions in mm

• All specifications are subject to change without notice.