

Choke Coils for PFC

Pin terminal type

PFC series

PFC3514QM

PFC3318QM

PFC3519QM

PFC3819QM

PFC4124QM

PFC2723ER

PFC3125ER

PFC3525ER

PFC3820QN

PFC3831QN

An attention matter on use

Please read this specifications before using this product by all means.

An attention matter on security

I undertake use with this product, and it is paid attention enough, and please design an attention matter safely.

Attention on a design

- When you designs a base of an electric circuit.
Please use size of the hole or pad which we recommend.
- Magnetic flux to leak out occurs. Please confirm it about influence of magnetic flux beforehand.
There is fear to cause false movement of machinery.
- In a design of a base of an electric circuit, Please consider the next contents.
In an applied safe standard.
The trans and distance with other parts
- The product is not quakeproof structure.
Accordingly please do not add vibration and a shock to it.
There is fear to lose a function.

Attention on the handling

- Please do not use it when you let a product drop.
The product produces possibility to lose a function
- Please pay attention to the pin which had it pointed keenly.
There is danger to injure.
- Please avoid the next place. The place that receives a drop of water, trash, the dust, foggy influence. The place where direct rays of the sun hits. There is fear to cause false movement of machinery.
- Please prohibit safekeeping and use at the next place. Environment to be accompanied with gas corrosion, salt, acid, alkali. There is fear to lose a function.
- When you carry the product on a base of an electric circuit.
Please do not use a metal tool. Because impossible power is added to a product.
There is fear to lose a function.

Attention

- I considered the next matter, and we designed a product.
Safe standard and power supply voltage and circuit drive condition, drive frequency and Duty ON-TIME.
By those conditions, we decided structure and the turns number.
Please avoid use in designed condition outside.
There are destruction of a circuit part and fear of ignition.
- This product considered a characteristic of a component and a self temperature rise, and it was made.
We select range of humidity as use temperature already.
Please avoid use by range more than this.
There are the damage and fear of ignition.
- Please avoid use in the environment next.
The environment that trash and the dust stick to a product. There is fear to cause a fire.
- The products listed on this specification sheet are intended for use in general electronic equipment (AV equipment, telecommunications equipment, home appliances, amusement equipment, computer equipment, personal equipment, office equipment, measurement equipment, industrial robots) under a normal operation and use condition.
- The products are not designed or warranted to meet the requirements of the applications listed below, whose performance and/or quality require a more stringent level of safety or reliability, or whose failure, malfunction or trouble could cause serious damage to society, person or property.
- If you intend to use the products in the applications listed below or if you have special requirements exceeding the range or conditions set forth in this catalog, please contact us.

- (1) Aerospace/Aviation equipment
- (2) Transportation equipment (cars, electric trains, ships, etc.)
- (3) Medical equipment
- (4) Power-generation control equipment
- (5) Atomic energy-related equipment
- (6) Seabed equipment applications
- (7) Transportation control equipment

- (8) Public information-processing equipment
- (9) Military equipment
- (10) Electric heating apparatus, burning equipment
- (11) Disaster prevention/crime prevention equipment
- (12) Safety equipment
- (13) Other applications that are not considered general-purpose applications

When designing your equipment even for general-purpose applications, you are kindly requested to take into consideration securing protection circuit/device or providing backup circuits in your equipment.

Choke Coils for PFC

PFC series

Contents	Page
Development Concept	4
Overview.....	5
PFC3514QM (Height from the board : 15.5mm)	6
PFC3318QM (Height from the board : 20mm)	8
PFC3519QM (Height from the board : 20mm)	10
PFC3819QM (Height from the board : 20mm)	12
PFC4124QM (Height from the board : 25mm)	14
PFC2723ER (Height from the board : 25mm)	16
PFC3125ER (Height from the board : 27mm)	18
PFC3525ER (Height from the board : 27mm)	20
PFC3820QN (Height from the board: 50mm Narrow floor space)	22
PFC3831QN (Height from the board: 50mm Narrow floor space)	24
Specification Request Form	26

Choke Coils for PFC

Pin terminal type

Development Concept of the PFC series

This is a power - factor improvement circuit for choke coils for smaller, thinner and narrow floor space in recent years electronic equipment.

■ MATERIAL

Thanks to the development of an optimized core shape and materials, the choke coil has DC superimposition characteristics suitable for the design of various types of electronic devices.

Optimized materials have been selected, and at the same time the original core shape for PFC has been developed.

The product line-up has been expanded to cater for various types of electronic devices that need to become smaller, thinner and narrow floor space.

■ MANUFACTURING METHOD

Since the PFC Series supports automatic winding, the product is of a high quality and can be manufactured stably.

It is designed to support automatic winding, which enables a remarkable reduction in the loss generated to achieve a proficient in manual winding until stable production.

In addition, the characteristic variations of the winding wire and creepage tape have largely been removed, stabilizing the transformer's characteristics.

■ OPTIMIZATION DESIGN

While the existing line-up of standard products remains available, new products can also be manufactured to meet customers' requests. Using design tools developed with TDK's comprehensive know-how, high-precision design has been achieved in a short period of time.

- 1) For optimization design and high-quality stable production, customers can use a specification request form.
If you provide the necessary information in the form, you will receive the optimization design in a short time.
- 2) TDK recommends design with a standard core gap (AL-value) for optimization and shorter trial and mass production lead time.

■ ENVIRONMENT

The PFC series is RoHS directive-compliant product.

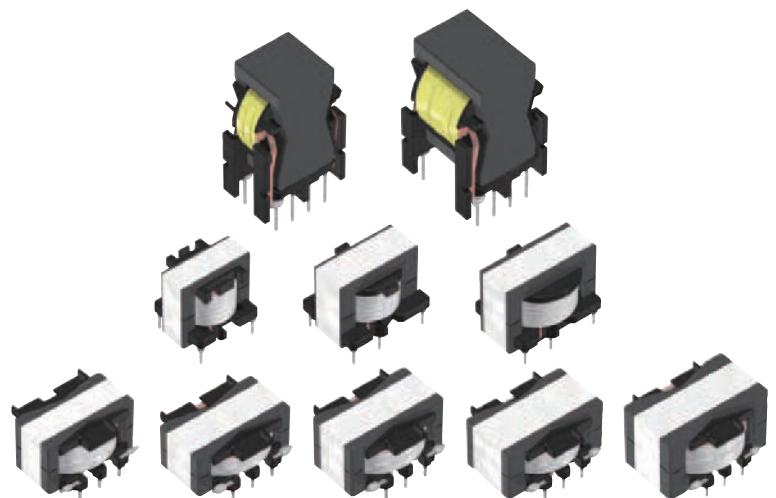

Choke Coils for PFC

Product compatible with RoHS directive
Compatible with lead-free solders

Pin terminal type

Overview of the PFC series

FEATURES

- A low height(15.5 to 27mm in height) and narrow floor space(QN type) are achieved.
- Large current is achieved in a small shape.

APPLICATION

AV equipment, digital consumer electronics

PART NUMBER CONSTRUCTION

PFC		3514QM		-		351		K		07		E-**	
Series name	Core shape	Inductance code		Inductance tolerance		Rated Peak current code ^{*1}		Internal code					
PFC3514QM		350	35μH (35x10 ⁰)	K	±10%	01	1A						
PFC3318QM		351	350μH (35x10 ¹)			07	7A						
PFC3519QM		352	3500μH(35x10 ²)			10	10A						
PFC3819QM													
PFC4124QM													
PFC2723ER													
PFC3125ER													
PFC3525ER													
PFC3820QN													
PFC3831QN													

*1 The rounded-off value.

OPERATING TEMPERATURE RANGE, PACKAGE QUANTITY, PRODUCT WEIGHT

Type	Temperature range		Package quantity (pieces/box)	Individual weight ^{*4} (g)
	Operating temperature ^{*2}	Storage temperature ^{*3}		
	(°C)	(°C)		
PFC3514QM	-30 to +120	-40 to +80	175	40.0
PFC3318QM	-30 to +120	-40 to +80	140	27.6
PFC3519QM	-30 to +120	-40 to +80	140	50.3
PFC3819QM	-30 to +120	-40 to +80	100	60.5
PFC4124QM	-30 to +120	-40 to +80	90	91.9
PFC2723ER	-30 to +120	-40 to +80	150	34.1
PFC3125ER	-30 to +120	-40 to +80	120	49.7
PFC3525ER	-30 to +120	-40 to +80	120	57.3
PFC3820QN	-30 to +120	-40 to +80	105	71.9
PFC3831QN	-30 to +120	-40 to +80	63	115.3

*2 Operating temperature range includes self-temperature rise.

*3 The Storage temperature range is for after the circuit board is mounted.

*4 Typical weight.

○ RoHS Directive Compliant Product: See the following for more details.<https://product.tdk.com/info/en/environment/rohs/index.html>

 Please be sure to request delivery specifications that provide further details on the features and specifications of the products for proper and safe use.
Please note that the contents may change without any prior notice due to reasons such as upgrading.

PFC QM series

PFC3514QM Type

SHAPE & DIMENSIONS

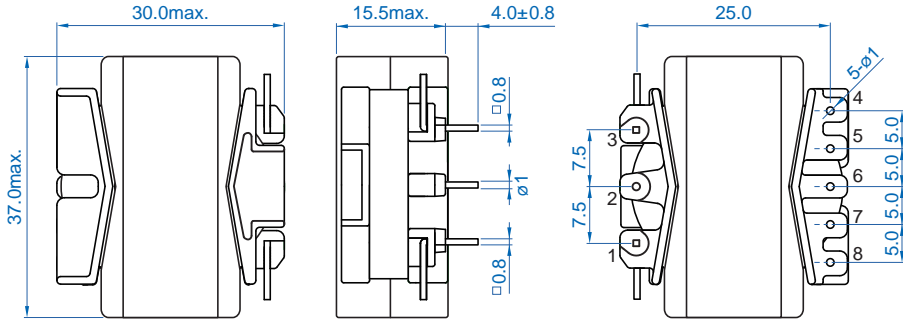

Dimensions in mm

RECOMMENDED LAND PATTERN

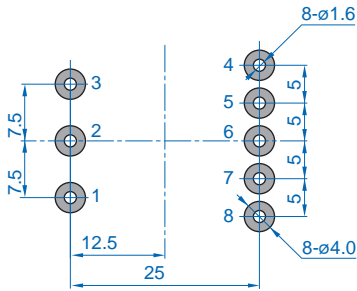

Dimensions in mm

CIRCUIT DIAGRAM

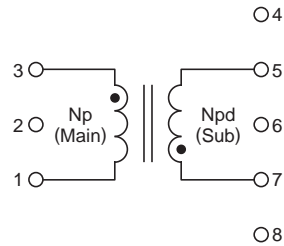

 Please be sure to request delivery specifications that provide further details on the features and specifications of the products for proper and safe use. Please note that the contents may change without any prior notice due to reasons such as upgrading.

PFC QM series PFC3514QM Type

ELECTRICAL CHARACTERISTICS

CHARACTERISTICS SPECIFICATION TABLE

Part number	Mount method	Frequency (kHz) min.	PFC output power (W)	Inductance (μH)	Rated peak current* ¹ (A)	Turn ratio (Np/Npd)
PFC3514QM-351K04B-00	Through hole	65	100	350	3.7	10.0
PFC3514QM-281K05B-00	Through hole	65	125	280	4.6	9.8
PFC3514QM-231K06B-00	Through hole	65	150	230	5.5	9.6

Measurement equipment*²

Measurement item	Product No.	Manufacturer
Inductance	4284A	Keysight Technologies
DC bias characteristics	4284A + 42841A	Keysight Technologies

*¹ The rated peak current is determined by the triangular waveform current when the temperature increase is less than 40°C during continuous operation.

*² Equivalent measurement equipment may be used.

INDUCTANCE CHANGE VS. DC BIAS CHARACTERISTICS GRAPH

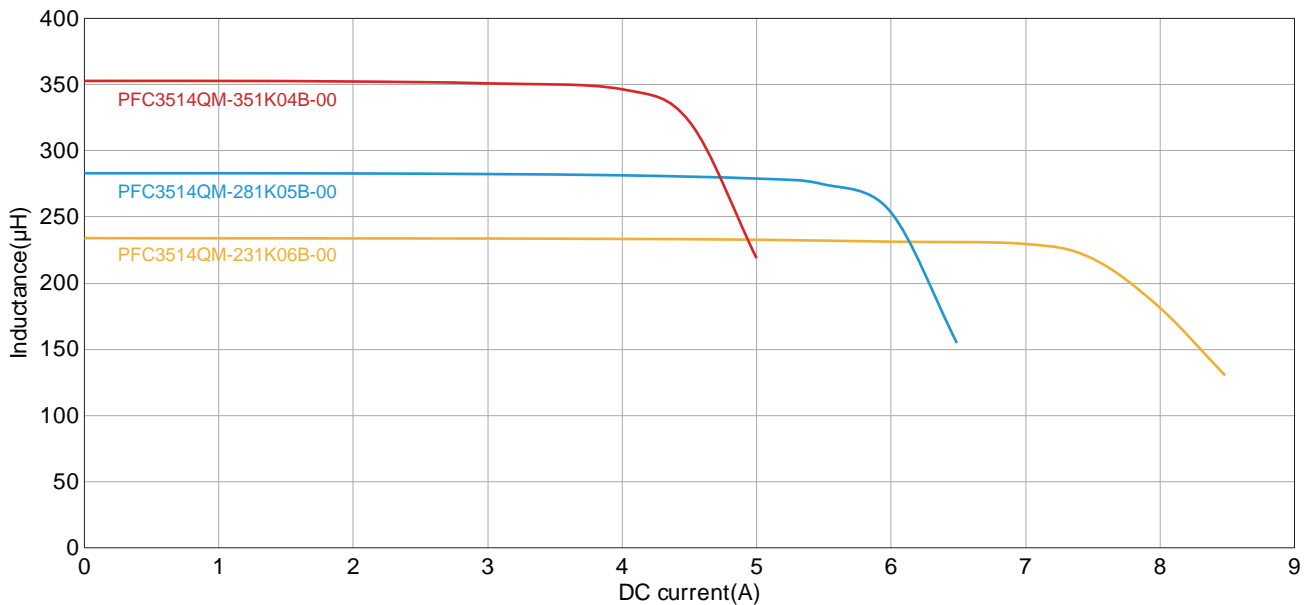

PFC QM series

PFC3318QM Type

SHAPE & DIMENSIONS

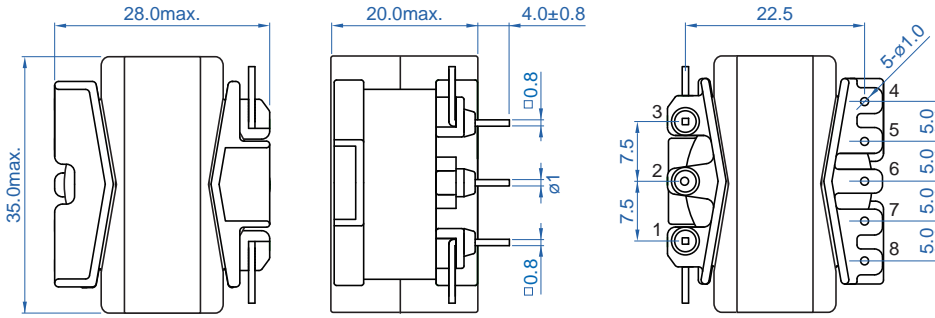

Dimensions in mm



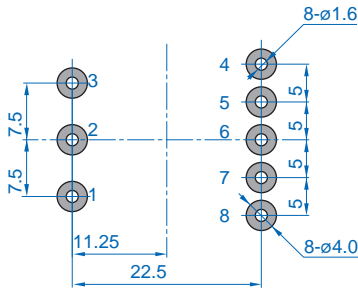

RECOMMENDED LAND PATTERN

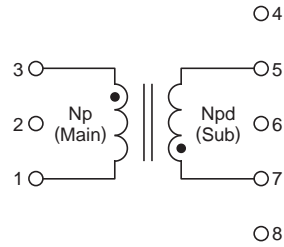

Dimensions in mm

CIRCUIT DIAGRAM



 Please be sure to request delivery specifications that provide further details on the features and specifications of the products for proper and safe use. Please note that the contents may change without any prior notice due to reasons such as upgrading.

PFC QM series PFC3318QM Type

ELECTRICAL CHARACTERISTICS

CHARACTERISTICS SPECIFICATION TABLE

Part number	Mount method	Frequency (kHz) min.	PFC output power (W)	Inductance (μH)	Rated peak current* ¹ (A)	Turn ratio (Np/Npd)
PFC3318QM-601K03B-00	Through hole	50	75	600	2.8	9.0
PFC3318QM-601K03E-00	Through hole	50	75	600	2.8	9.6
PFC3318QM-451K04B-00	Through hole	50	100	450	3.7	9.0

Measurement equipment*²

Measurement item	Product No.	Manufacturer
Inductance	4284A	Keysight Technologies
DC bias characteristics	4284A + 42841A	Keysight Technologies

*¹ The rated peak current is determined by the triangular waveform current when the temperature increase is less than 40°C during continuous operation.

*² Equivalent measurement equipment may be used.

INDUCTANCE CHANGE VS. DC BIAS CHARACTERISTICS GRAPH

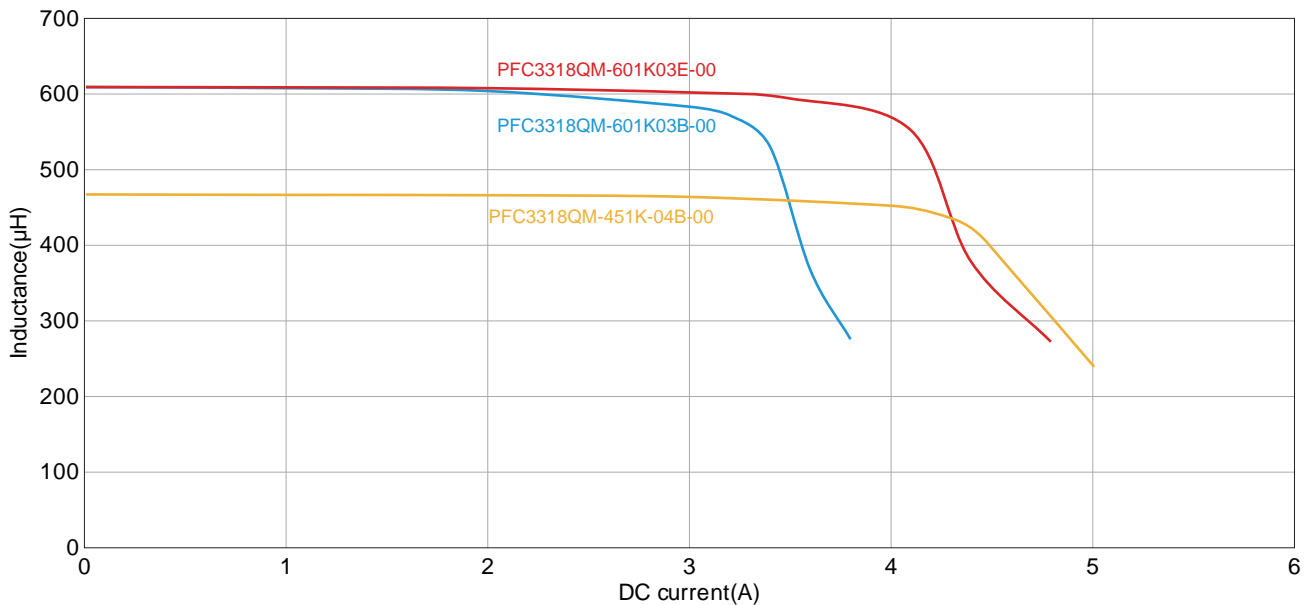

PFC QM series

PFC3519QM Type

SHAPE & DIMENSIONS

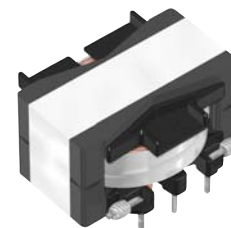
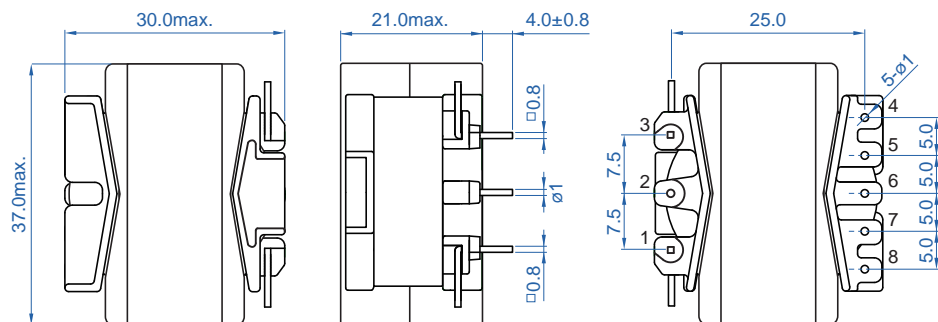

Dimensions in mm

RECOMMENDED LAND PATTERN

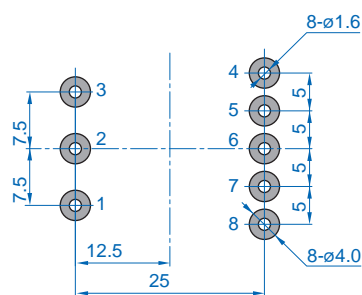

Dimensions in mm

CIRCUIT DIAGRAM

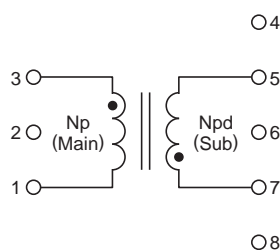

⚠ Please be sure to request delivery specifications that provide further details on the features and specifications of the products for proper and safe use. Please note that the contents may change without any prior notice due to reasons such as upgrading.

PFC QM series PFC3519QM Type

ELECTRICAL CHARACTERISTICS

CHARACTERISTICS SPECIFICATION TABLE

Part number	Mount method	Frequency (kHz) min.	PFC output power (W)	Inductance (μH)	Rated peak current* ¹ (A)	Turn ratio (Np/Npd)
PFC3519QM-451K04E-00	Through hole	50	100	450	3.7	10
PFC3519QM-301K06B-50	Through hole	50	150	300	5.5	9.8
PFC3519QM-231K07B-50	Through hole	50	200	230	7.4	9.6

Measurement equipment*²

Measurement item	Product No.	Manufacturer
Inductance	4284A	Keysight Technologies
DC bias characteristics	4284A + 42841A	Keysight Technologies

*¹ The rated peak current is determined by the triangular waveform current when the temperature increase is less than 40°C during continuous operation.

*² Equivalent measurement equipment may be used.

INDUCTANCE CHANGE VS. DC BIAS CHARACTERISTICS GRAPH

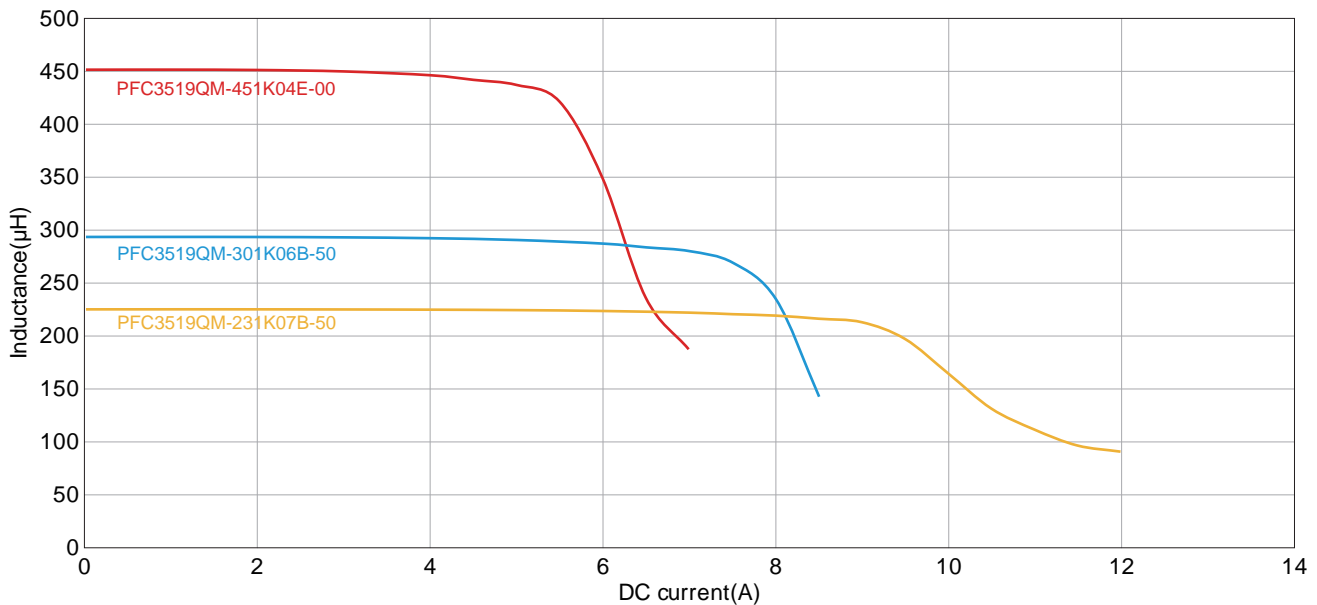

PFC QM series

PFC3819QM Type

SHAPE & DIMENSIONS

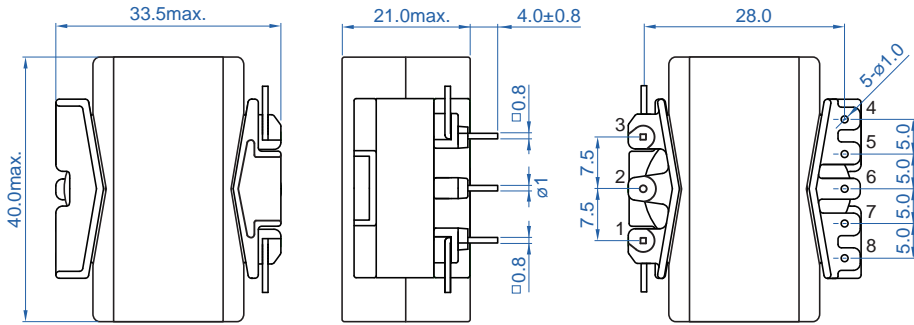

Dimensions in mm

RECOMMENDED LAND PATTERN

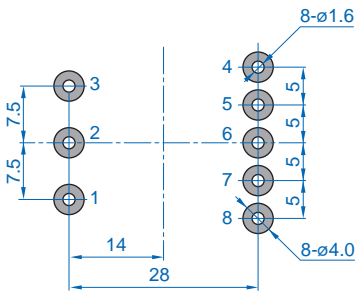

Dimensions in mm

CIRCUIT DIAGRAM

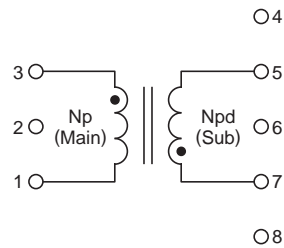

 Please be sure to request delivery specifications that provide further details on the features and specifications of the products for proper and safe use. Please note that the contents may change without any prior notice due to reasons such as upgrading.

PFC QM series PFC3819QM Type

ELECTRICAL CHARACTERISTICS

CHARACTERISTICS SPECIFICATION TABLE

Part number	Mount method	Frequency (kHz) min.	PFC output power (W)	Inductance (μH)	Rated peak current* ¹ (A)	Turn ratio (Np/Npd)
PFC3819QM-301K06E-50	Through hole	50	150	300	5.5	9.8
PFC3819QM-231K07D-50	Through hole	50	200	230	7.4	9.6
PFC3819QM-181K09B-50	Through hole	50	250	180	8.8	9.5
PFC3819QM-151K11B-00	Through hole	50	300	150	11.1	9.8

Measurement equipment*²

Measurement item	Product No.	Manufacturer
Inductance	4284A	Keysight Technologies
DC bias characteristics	4284A + 42841A	Keysight Technologies

*¹ The rated peak current is determined by the triangular waveform current when the temperature increase is less than 40°C during continuous operation.

*² Equivalent measurement equipment may be used.

INDUCTANCE CHANGE VS. DC BIAS CHARACTERISTICS GRAPH

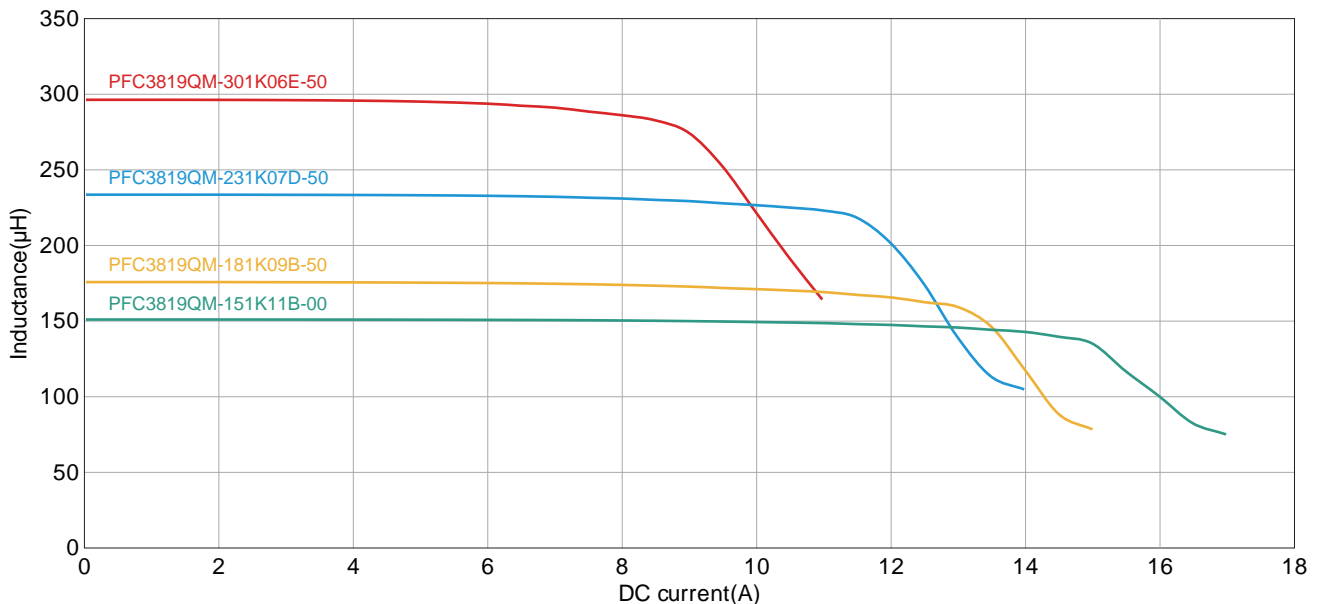

PFC QM series

PFC4124QM Type

SHAPE & DIMENSIONS

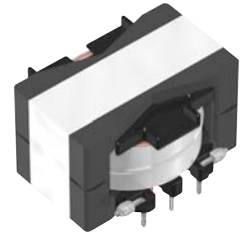
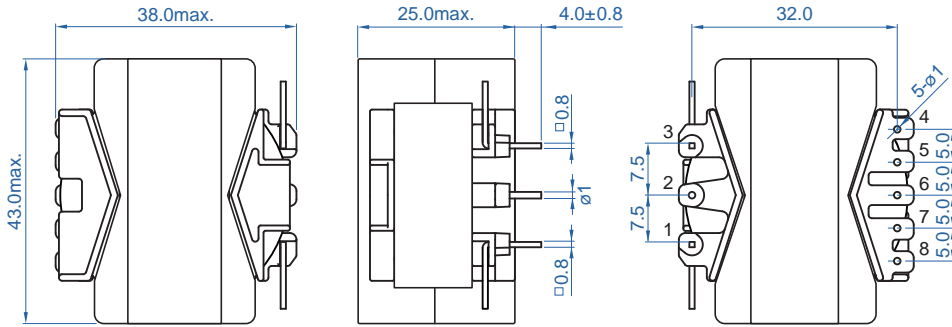

Dimensions in mm

RECOMMENDED LAND PATTERN

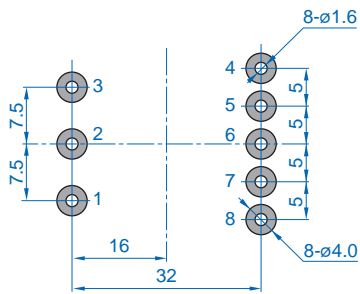

Dimensions in mm

CIRCUIT DIAGRAM

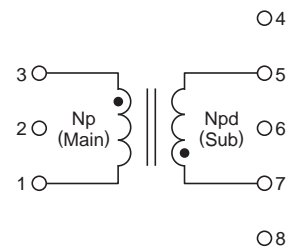

 Please be sure to request delivery specifications that provide further details on the features and specifications of the products for proper and safe use. Please note that the contents may change without any prior notice due to reasons such as upgrading.

PFC QM series PFC4124QM Type

ELECTRICAL CHARACTERISTICS

CHARACTERISTICS SPECIFICATION TABLE

Part number	Mount method	Frequency (kHz) min.	PFC output power (W)	Inductance (μH)	Rated peak current* ¹ (A)	Turn ratio (Np/Npd)
PFC4124QM-181K09D-00	Through hole	50	250	180	8.8	9.5
PFC4124QM-151K11D-00	Through hole	50	300	150	11.1	9.8

Measurement equipment*²

Measurement item	Product No.	Manufacturer
Inductance	4284A	Keysight Technologies
DC bias characteristics	4284A + 42841A	Keysight Technologies

*¹ The rated peak current is determined by the triangular waveform current when the temperature increase is less than 40°C during continuous operation.

*² Equivalent measurement equipment may be used.

INDUCTANCE CHANGE VS. DC BIAS CHARACTERISTICS GRAPH

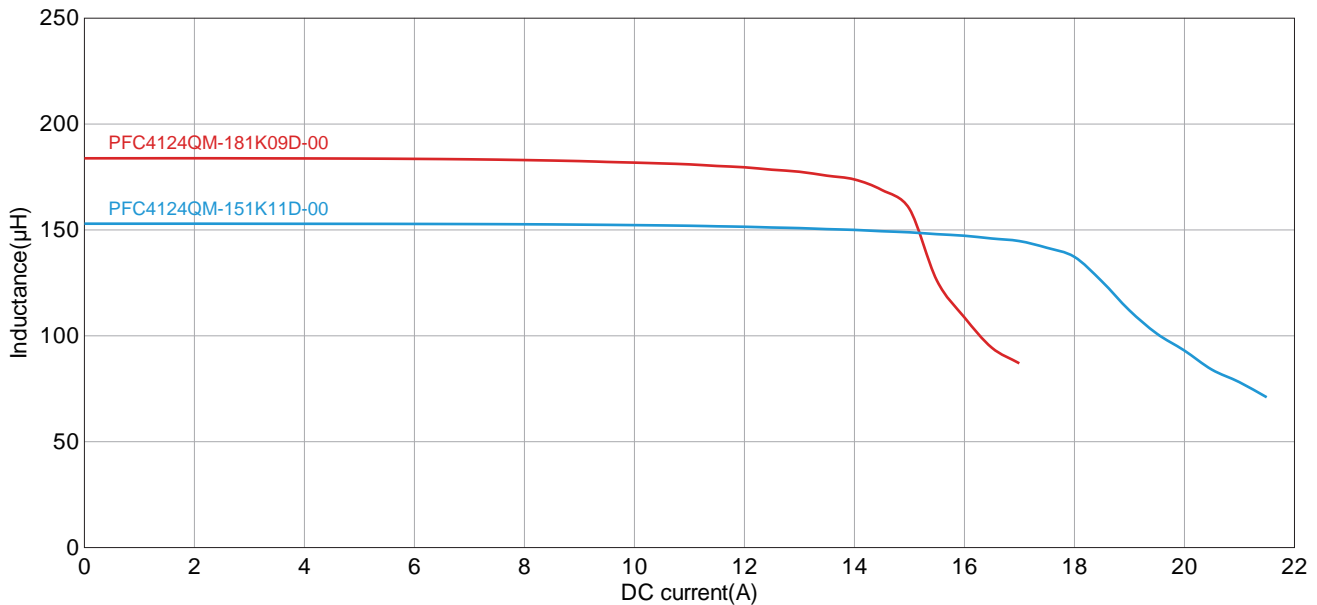

PFC ER series PFC2723ER Type

ELECTRICAL CHARACTERISTICS

CHARACTERISTICS SPECIFICATION TABLE

Part number	Mount method	Frequency (kHz) min.	PFC output power (W)	Inductance (μH)	Rated peak current* ¹ (A)	Turn ratio (Np/Npd)
PFC2723ER-601K02B-00	Through hole	50	75	600	2.4	9.8
PFC2723ER-421K03B-50	Through hole	50	100	420	3.4	10.8

Measurement equipment*²

Measurement item	Product No.	Manufacturer
Inductance	4284A	Keysight Technologies
DC bias characteristics	4284A + 42841A	Keysight Technologies

*¹ The rated peak current is determined by the triangular waveform current when the temperature increase is less than 40°C during continuous operation.

*² Equivalent measurement equipment may be used.

INDUCTANCE CHANGE VS. DC BIAS CHARACTERISTICS GRAPH

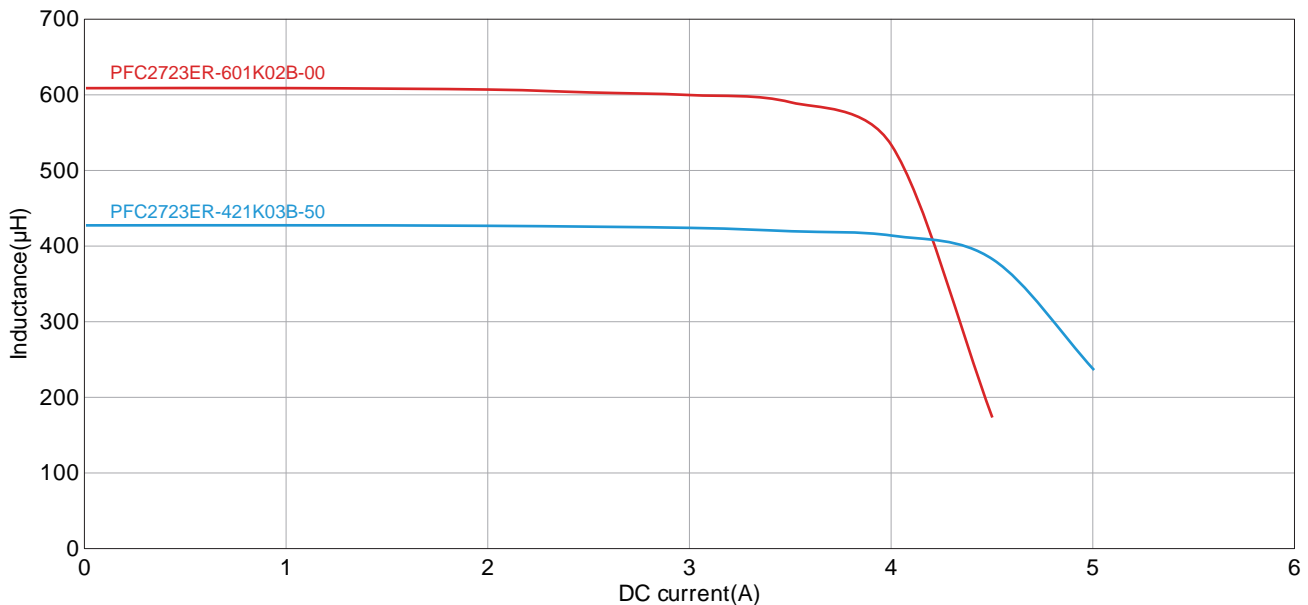

PFC ER series

PFC3125ER Type

SHAPE & DIMENSIONS

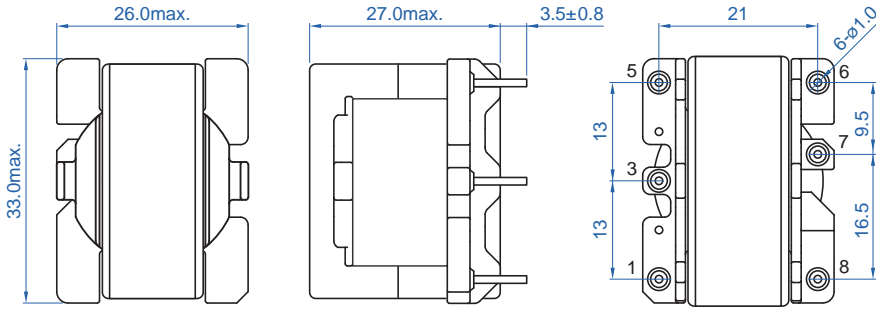

Dimensions in mm



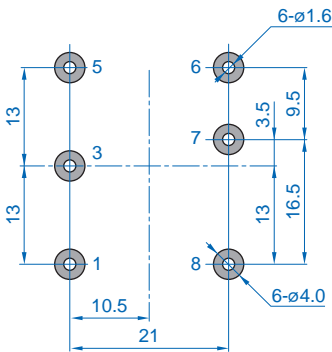

RECOMMENDED LAND PATTERN

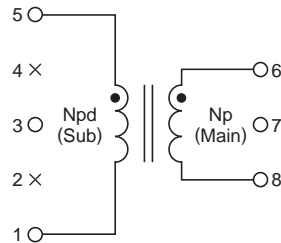

Dimensions in mm

CIRCUIT DIAGRAM



 Please be sure to request delivery specifications that provide further details on the features and specifications of the products for proper and safe use. Please note that the contents may change without any prior notice due to reasons such as upgrading.

PFC ER series PFC3125ER Type

ELECTRICAL CHARACTERISTICS

CHARACTERISTICS SPECIFICATION TABLE

Part number	Mount method	Frequency (kHz) min.	PFC output power (W)	Inductance (μH)	Rated peak current* ¹ (A)	Turn ratio (Np/Npd)
PFC3125ER-451K03E-00	Through hole	50	100	450	2.7	10.0
PFC3125ER-301K05B-00	Through hole	50	150	300	4.9	10.4
PFC3125ER-231K06B-00	Through hole	50	200	230	6.4	9.0

Measurement equipment*²

Measurement item	Product No.	Manufacturer
Inductance	4284A	Keysight Technologies
DC bias characteristics	4284A + 42841A	Keysight Technologies

*¹ The rated peak current is determined by the triangular waveform current when the temperature increase is less than 40°C during continuous operation.

*² Equivalent measurement equipment may be used.

INDUCTANCE CHANGE VS. DC BIAS CHARACTERISTICS GRAPH

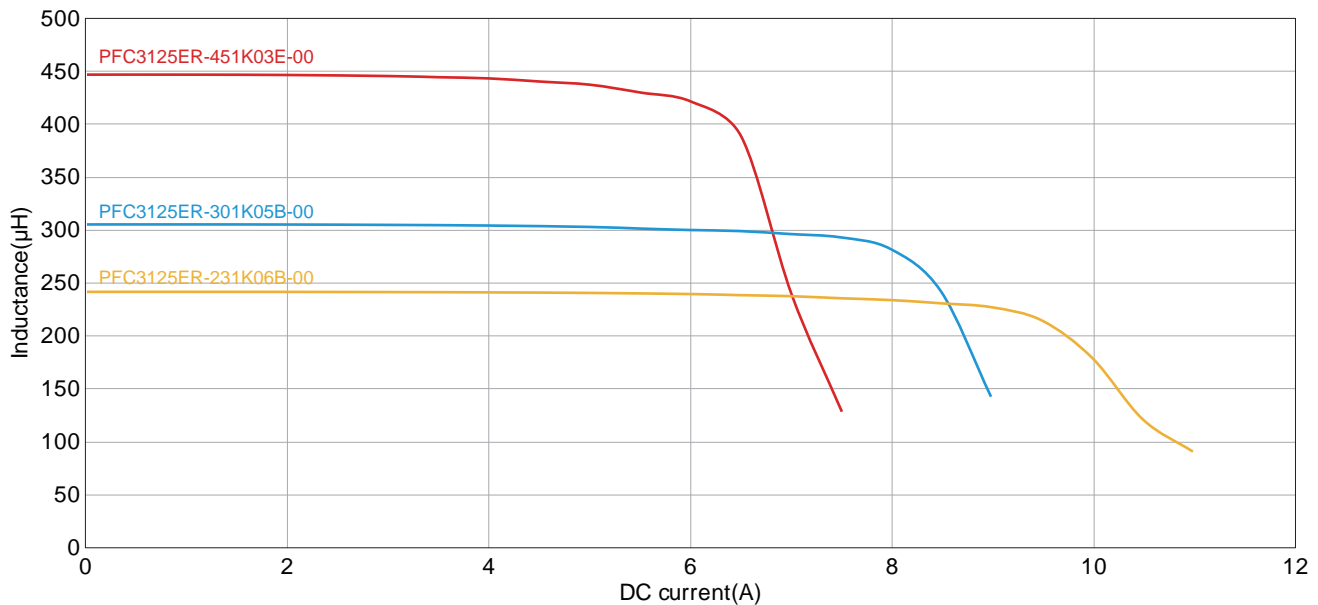

PFC ER series PFC3525ER Type

ELECTRICAL CHARACTERISTICS

CHARACTERISTICS SPECIFICATION TABLE

Part number	Mount method	Frequency (kHz) min.	PFC output power (W)	Inductance (μH)	Rated peak current* ¹ (A)	Turn ratio (Np/Npd)
PFC3525ER-301K04E-00	Through hole	50	150	300	4.1	10.4
PFC3525ER-231K06E-00	Through hole	50	200	225	5.6	10.0
PFC3525ER-181K09B-00	Through hole	50	250	180	9.5	10.5

Measurement equipment*²

Measurement item	Product No.	Manufacturer
Inductance	4284A	Keysight Technologies
DC bias characteristics	4284A + 42841A	Keysight Technologies

*¹ The rated peak current is determined by the triangular waveform current when the temperature increase is less than 40°C during continuous operation.

*² Equivalent measurement equipment may be used.

INDUCTANCE CHANGE VS. DC BIAS CHARACTERISTICS GRAPH

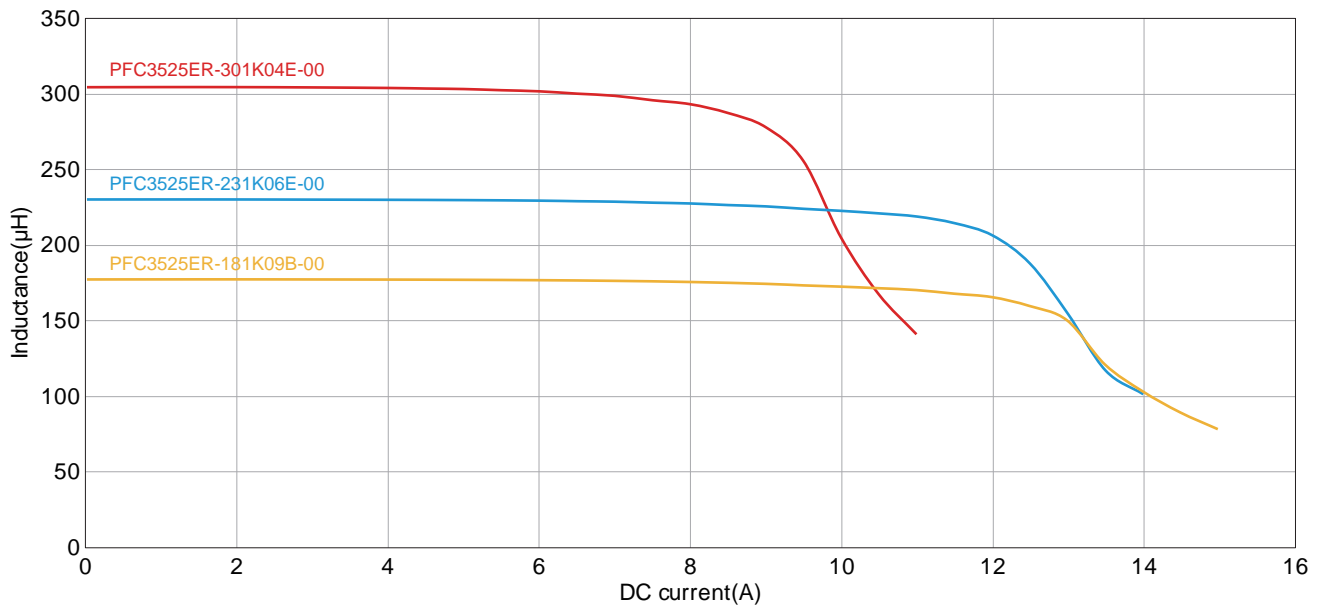

PFC QN series

PFC3820QN Type

SHAPE & DIMENSIONS

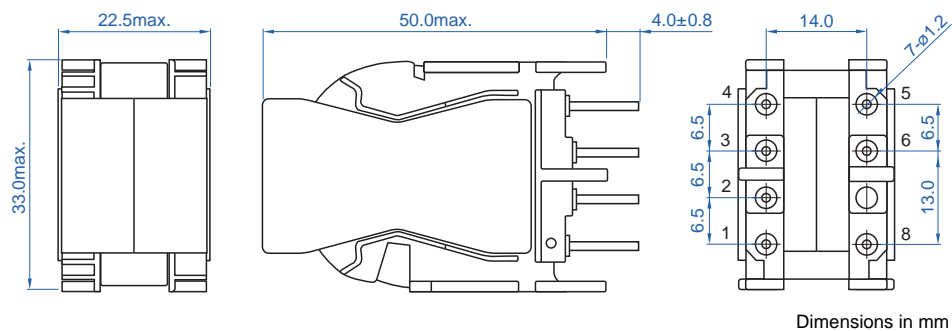

RECOMMENDED LAND PATTERN

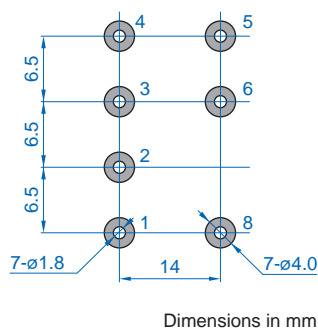

CIRCUIT DIAGRAM

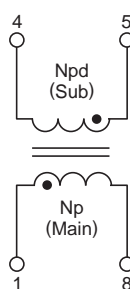

PFC QN series **PFC3820QN Type**

■ ELECTRICAL CHARACTERISTICS

□ CHARACTERISTICS SPECIFICATION TABLE

Part number	Mount method	Frequency (kHz) min.	PFC output power* ¹ (W)	Inductance (μH)	Rated peak current* ² (A)	Turn ratio (Np/Npd)
PFC3820QN-900K11B-00	Through hole	35	800	90	11	7

○ Measurement equipment*³

Measurement item	Product No.	Manufacturer
Inductance	4284A	Keysight Technologies
DC bias characteristics	4284A + 42841A	Keysight Technologies

*¹ Output power at 220 Vac input.*² The rated peak current is determined by the triangular waveform current when the temperature increase is less than 40°C during continuous operation.*³ Equivalent measurement equipment may be used.

□ INDUCTANCE CHANGE VS. DC BIAS CHARACTERISTICS GRAPH

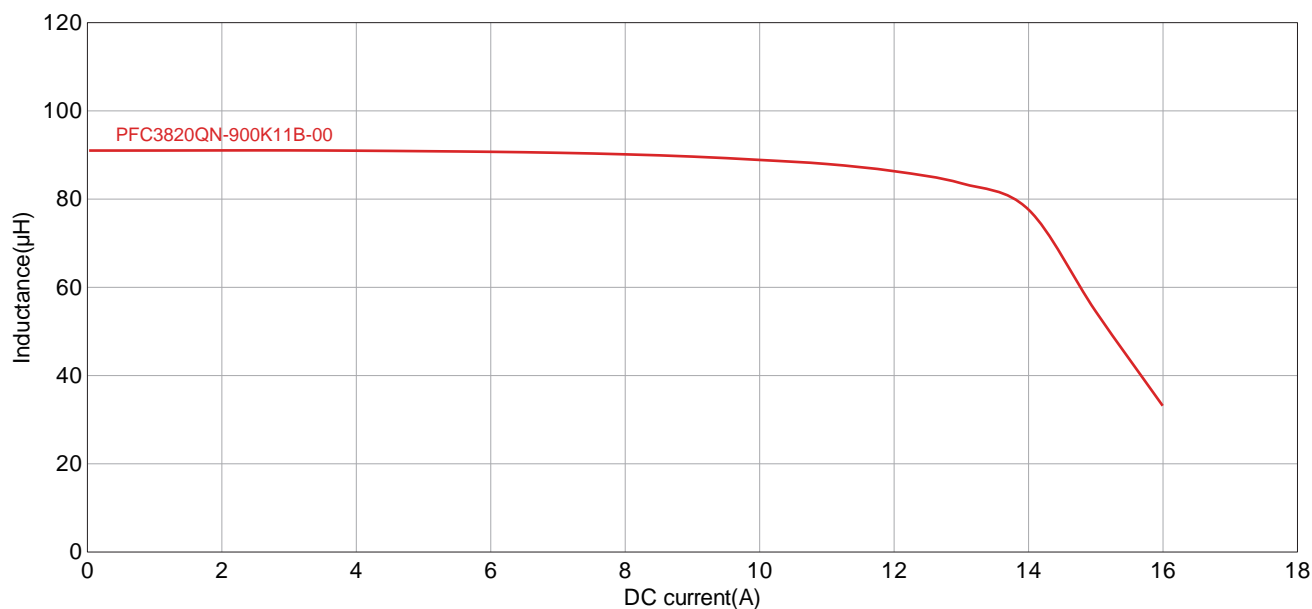

PFC QN series

PFC3831QN Type

SHAPE & DIMENSIONS

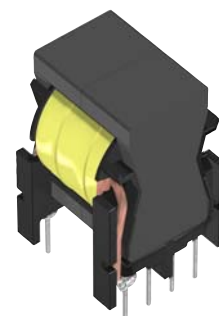
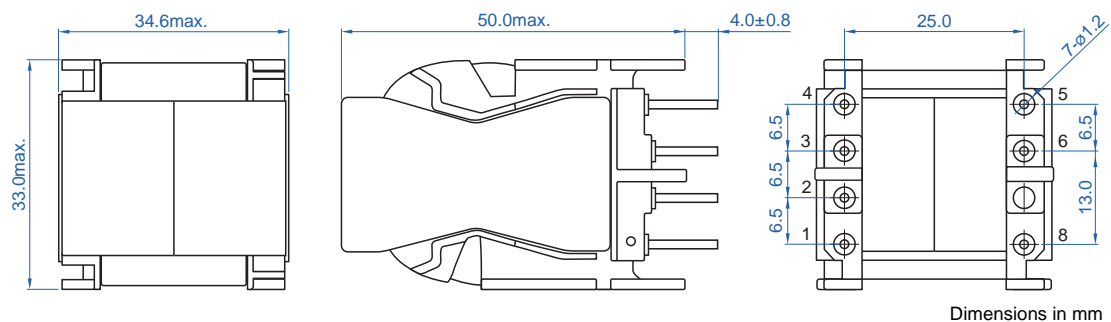

RECOMMENDED LAND PATTERN

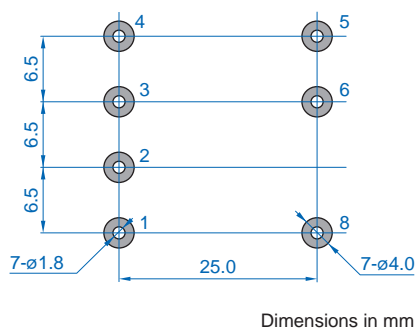

CIRCUIT DIAGRAM

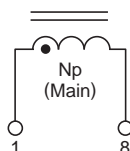

⚠ Please be sure to request delivery specifications that provide further details on the features and specifications of the products for proper and safe use. Please note that the contents may change without any prior notice due to reasons such as upgrading.

PFC QN series **PFC3831QN Type**

■ ELECTRICAL CHARACTERISTICS

□ CHARACTERISTICS SPECIFICATION TABLE

Part number	Mount method	Frequency (kHz) min.	PFC output power* ¹ (W)	Inductance (μH)	Rated peak current* ² (A)	Turn ratio (Np/Npd)
PFC3831QN-351K08B-00	Through hole	50	900	350	8	—

○ Measurement equipment*³

Measurement item	Product No.	Manufacturer
Inductance	4284A	Keysight Technologies
DC bias characteristics	4284A + 42841A	Keysight Technologies

*¹ Output power at 220 Vac input.*² The rated peak current is determined by the triangular waveform current when the temperature increase is less than 40°C during continuous operation.*³ Equivalent measurement equipment may be used.

□ INDUCTANCE CHANGE VS. DC BIAS CHARACTERISTICS GRAPH

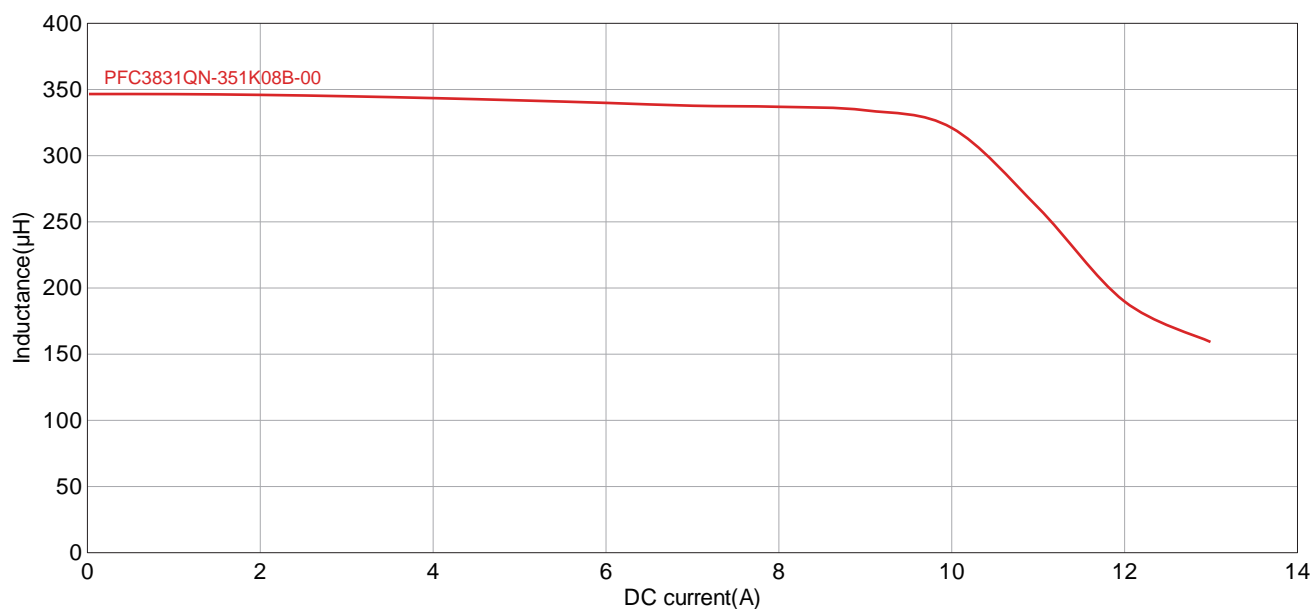

Choke Coils for PFC Specification Request Form

Issued on _____

1. **Company name** _____

Address _____

2. **Department, applicant's name**

Name: _____

TEL/FAX : _____

E-mail : _____

3. **Circuit system**

Continuous mode Critical mode Interleave Other (_____)

4. **Input specifications**

AC input voltage: Rated _____ (V) ~ _____ (V) Operating range: _____ (V) ~ _____ (V)

Frequency _____ (Hz) Minimum operating input voltage: _____ (V) ~ _____ (V)

5. **Design condition**

(1) Clock frequency Continuous mode(fixed frequency) : _____ (kHz)

Critical mode(lowest frequency) : _____ (kHz)

(2) Output voltage _____ (Vdc)

(3) Rated output power/Maximum peak power _____ (W) / _____ (W)

(4) Minimum operating input voltage _____ (Vac)

(5) Overcurrent point condition (ex.: 130% in (3)Rated output power and (4) Minimum operating input voltage) _____ (%)

(6) Maximum temperature rise ΔT _____ (°C)

Condition in temperature evaluation (ex.: minimum input, rated load)

(7) Auxiliary winding Yes No

Number of windings _____ (Windings)

Desired voltage value and current _____ (V) / _____ (mA)

Necessity of insulation Functional insulation Reinforced insulation

(8) Circuit diagram (If you desire any pin number, attach a circuit diagram.) Yes No

6. **Inductance value and saturated current value for reference**

Inductance value _____ μ (H) Saturated current value _____ (A)

7. **Desired core size and external size**

Core size: _____ External size L: _____ W: _____ H(Height from the board): _____ mm max.

8. **IC expected to be used**

Manufacturer name: _____ Product No.: _____

9. **Production quantity information**

Final set name: _____ Desired price/Currency: _____

Acceptance conditions of the above price (FCA CHN, CIP LA, DDP Paris etc.): _____

Production volume: _____ k/M Production start period: _____ Production place: _____

Prototyping time: (ES1) _____ (ES2) _____ (PP1) _____ (PP2) _____ (MP1) _____

10. **Sample information**

Required sample quantity: _____ pcs. Requested delivery time: _____

11. **Note company regulations, such as safe distance and dielectric voltage strength, if there are any.**

12. **If there are any other requests (priorities in the company, size or price, etc.) or alterable items, please provide a description.**

Person in Charge from Sales Promotion Dep.: _____	Recorded Date _____
Person in Charge from Sales Dep.: _____	Recorded Date _____
Prototype No: _____	Recorded Date _____