



3-terminal Filters

For Signal Line

YFF-SC Series

| | | |
|----------------|--------------------------|----------------------------|
| YFF15SC | 1005 [0402 inch]* | Feed through filter |
| YFF18SC | 1608 [0603 inch] | Feed through filter |
| YFF21SC | 2012 [0805 inch] | Feed through filter |

* Dimensions Code JIS[EIA]

3-terminal Filters

For Signal Line

Conformity to RoHS Directive
Compatible with lead-free solders

Overview of YFF-SC Series

FEATURES

- Small and high-performance EMC components.
- Good attenuation characteristic in high frequency ranges.

APPLICATIONS

High impedance circuits, e.g. digital signal circuits.
I/O interface sections of devices with electric circuits and the area around connectors.
Low-current power line of communication terminal devices, AV, and information devices.

PART NUMBER IDENTIFICATION

| YFF | 21 | SC | 1E | 473 | M | T | □□ | 0 | N | | | | | | | |
|-------------|----------------|---------|-----------------------|-----|---------------|----|-------------|---------------|-----------|--------|-------------------|-----------|------|-----------------------|---|------|
| Series name | L×W dimensions | | Product internal code | | Rated voltage | | Capacitance | | Tolerance | Taping | TDK internal code | Reel size | | Internal electrode Ni | | |
| | Code | mm | Code Signal line | | Code | V | Code | pF | | | | Code | mm | | | |
| | 15 | 1.0×0.5 | SC Signal line | | 1C | 16 | 220 | 22 | | | | M | ±20% | | 0 | ø178 |
| | 18 | 1.6×0.8 | | | 1E | 25 | 101 | 100 | | | | | | | 9 | ø330 |
| | 21 | 2.0×1.2 | | | 1H | 50 | 221 | 220 | | | | | | | | |
| | | | | | | | 473 | 47,000 (47nF) | | | | | | | | |

OPERATING TEMPERATURE RANGE, PACKAGE QUANTITY, PRODUCT WEIGHT

| Type | Package quantity (piece/reel) | | Individual weight (g) |
|---------|-------------------------------|--------|-----------------------|
| | ø178 | ø330 | |
| YFF15SC | 10,000 | 50,000 | 0.0008 |
| YFF18SC | 4,000 | 10,000 | 0.0038 |
| YFF21SC | 4,000 | 10,000 | 0.0095 |

* The Storage temperature range is for after the circuit board is mounted.

- Conformity to RoHS Directive: This means that, in conformity with EU Directive 2011/65/EC, lead, cadmium, mercury, hexavalent chromium, and specific bromine-based flame retardants, PBB and PBDE, have not been used, except for exempted applications.
- Please contact our Sales office when your application is considered the following:
The device's failure or malfunction may directly endanger human life (e.g. application for automobile/aircraft/medical/nuclear power devices, etc.)

Please be sure to request delivery specifications that provide further details on the features and specifications of the products for proper and safe use. Please note that the contents may change without any prior notice due to reasons such as upgrading.

Overview of YFF-SC Series

RECOMMENDED SOLDERING CONDITION

REFLOW SOLDERING

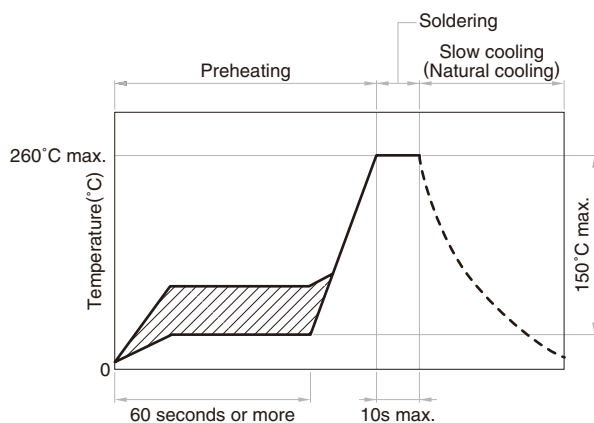

HAND SOLDERING

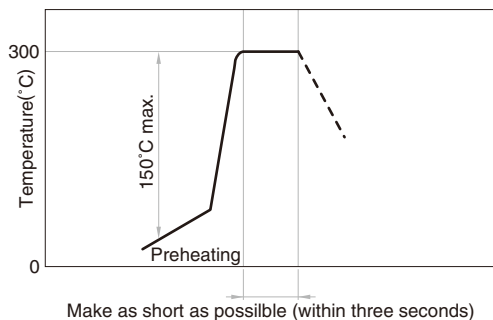

PRECAUTIONS FOR USE

- Before soldering, be sure to preheat components. The ΔT preheating temperature must be 150°C max. with attention paid to thermal shock.
- Natural cooling of components in the air is recommended. On the other hand, when dipping them in a solvent for purposes, such as cleaning, make sure that the temperature difference (ΔT) is 100°.
- When performing hand soldering for circuit modification, apply the soldering iron to the copper foil area of the printed circuit board for 3 seconds or less. The temperature of the iron tip should not exceed 300°C.
- Use a wrist band to discharge static electricity in your body through the grounding wire.
- When incorporating the printed circuit board on which this product is mounted into a frame, etc., do not apply stress to the product through local bending of the board by tightening of screws, etc.

YFF-SC Series YFF15SC Type (Feed Through Filter)

SHAPES AND DIMENSIONS

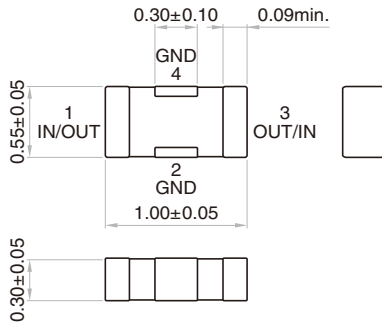

RECOMMENDED LAND PATTERN

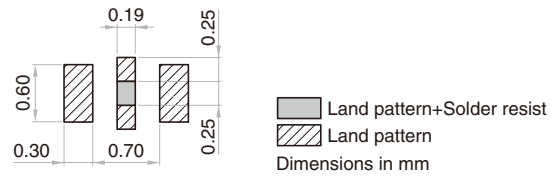

* Make sure to connect the GND terminal of this product and the GND of the mounting circuit board by using through holes so that the distance between them is the shortest.

ELECTRICAL CHARACTERISTICS

CHARACTERISTICS SPECIFICATION TABLE

| Cutoff frequency (MHz) | Insertion loss 30dB bandwidth (MHz) | Rated voltage Edc (V) | Rated current Idc (A) | Operating temperature range (°C) | Storage temperature range(After mount) (°C) | Part No.* |
|------------------------|-------------------------------------|-----------------------|-----------------------|----------------------------------|---|---|
| 0.1 | 5 to 4000 | 16 | 1 | -55 to 125 | -55 to 125 | YFF15SC1C473MT00 <input type="checkbox"/> N |
| 0.3 | 10 to 4000 | 16 | 1 | -55 to 125 | -55 to 125 | YFF15SC1C223MT00 <input type="checkbox"/> N |
| 0.6 | 20 to 4000 | 25 | 1 | -55 to 125 | -55 to 125 | YFF15SC1E103MT00 <input type="checkbox"/> N |
| 1 | 50 to 4000 | 25 | 1 | -55 to 125 | -55 to 125 | YFF15SC1E472MT00 <input type="checkbox"/> N |
| 3 | 100 to 4000 | 25 | 1 | -55 to 125 | -55 to 125 | YFF15SC1E222MT00 <input type="checkbox"/> N |
| 6 | 200 to 4000 | 25 | 1 | -55 to 125 | -55 to 125 | YFF15SC1E102MT00 <input type="checkbox"/> N |
| 10 | 600 to 4000 | 25 | 1 | -55 to 125 | -55 to 125 | YFF15SC1E471MT00 <input type="checkbox"/> N |
| 30 | 800 to 6000 | 50 | 1 | -55 to 125 | -55 to 125 | YFF15SC1H221MT00 <input type="checkbox"/> N |
| 60 | 1500 to 6000 | 50 | 1 | -55 to 125 | -55 to 125 | YFF15SC1H101MT00 <input type="checkbox"/> N |
| 100 | 2000 to 6000 | 50 | 1 | -55 to 125 | -55 to 125 | YFF15SC1H470MT00 <input type="checkbox"/> N |
| 300 | 4000 to 6000 | 50 | 1 | -55 to 125 | -55 to 125 | YFF15SC1H220MT00 <input type="checkbox"/> N |

* The part numbers are TDK's standard specification products.

* : Please specify reel size code, 0 (ø178) or 9 (ø330)

ELECTRICAL CHARACTERISTICS GRAPH (EXAMPLE)

INSERTION LOSS vs. FREQUENCY CHARACTERISTICS

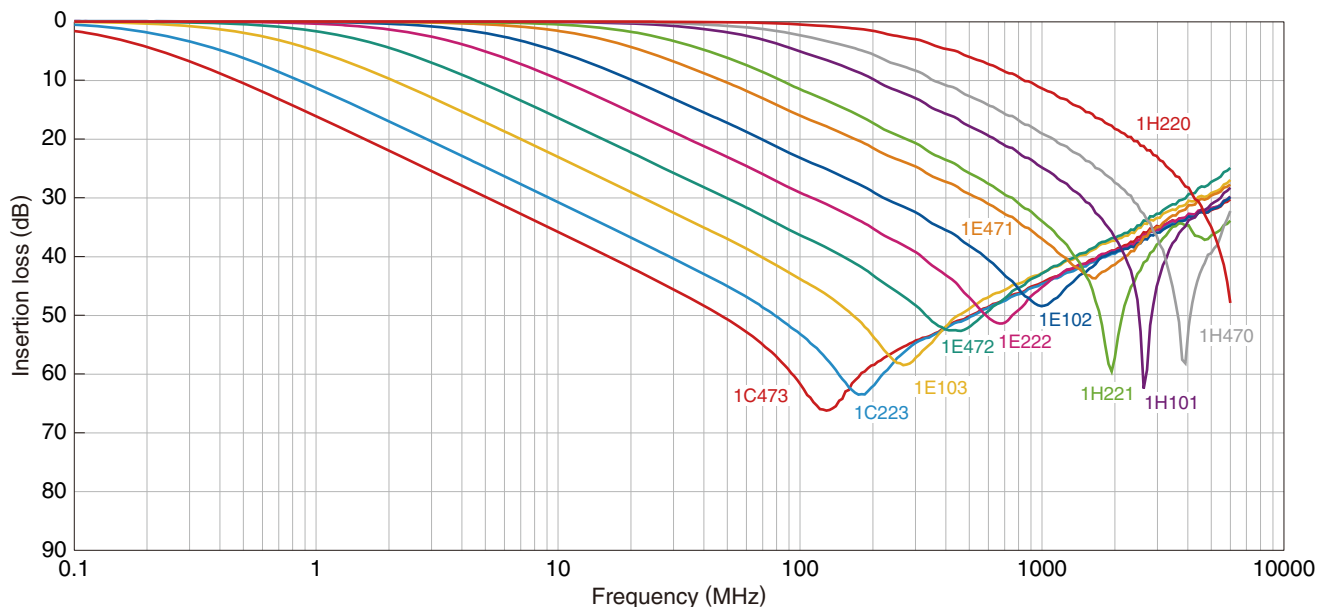

⚠ Please be sure to request delivery specifications that provide further details on the features and specifications of the products for proper and safe use. Please note that the contents may change without any prior notice due to reasons such as upgrading.

YFF-SC Series YFF18SC Type (Feed Through Filter)

SHAPES AND DIMENSIONS

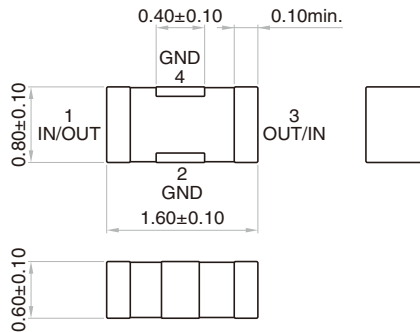

RECOMMENDED LAND PATTERN

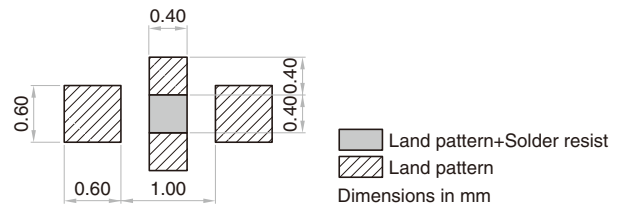

* Make sure to connect the GND terminal of this product and the GND of the mounting circuit board by using through holes so that the distance between them is the shortest.

ELECTRICAL CHARACTERISTICS

CHARACTERISTICS SPECIFICATION TABLE

| Cutoff frequency (MHz) | Insertion loss 30dB bandwidth (MHz) | Rated voltage Edc (V) | Rated current Idc (A) | Operating temperature range (°C) | Storage temperature range(After mount) (°C) | Part No.* |
|------------------------|-------------------------------------|-----------------------|-----------------------|----------------------------------|---|----------------------|
| 0.3 | 10 to 3000 | 50 | 1 | -55 to 125 | -55 to 125 | YFF18SC1H223MT0H □ N |
| 0.6 | 20 to 3000 | 50 | 1 | -55 to 125 | -55 to 125 | YFF18SC1H103MT0H □ N |
| 1 | 40 to 3000 | 50 | 1 | -55 to 125 | -55 to 125 | YFF18SC1H472MT0H □ N |
| 2 | 90 to 3000 | 50 | 1 | -55 to 125 | -55 to 125 | YFF18SC1H222MT0H □ N |
| 6 | 200 to 3000 | 50 | 1 | -55 to 125 | -55 to 125 | YFF18SC1H102MT0H □ N |
| 10 | 400 to 6000 | 50 | 1 | -55 to 125 | -55 to 125 | YFF18SC1H471MT0H □ N |
| 20 | 800 to 6000 | 50 | 1 | -55 to 125 | -55 to 125 | YFF18SC1H221MT0H □ N |
| 60 | 1500 to 6000 | 50 | 1 | -55 to 125 | -55 to 125 | YFF18SC1H101MT0H □ N |
| 100 | 2000 to 6000 | 50 | 1 | -55 to 125 | -55 to 125 | YFF18SC1H470MT0H □ N |
| 200 | 4000 to 6000 | 50 | 1 | -55 to 125 | -55 to 125 | YFF18SC1H220MT0H □ N |

* The part numbers are TDK's standard specification products.

* □: Please specify reel size code, 0 (ø178) or 9 (ø330)

ELECTRICAL CHARACTERISTICS GRAPH (EXAMPLE)

INSERTION LOSS vs. FREQUENCY CHARACTERISTICS

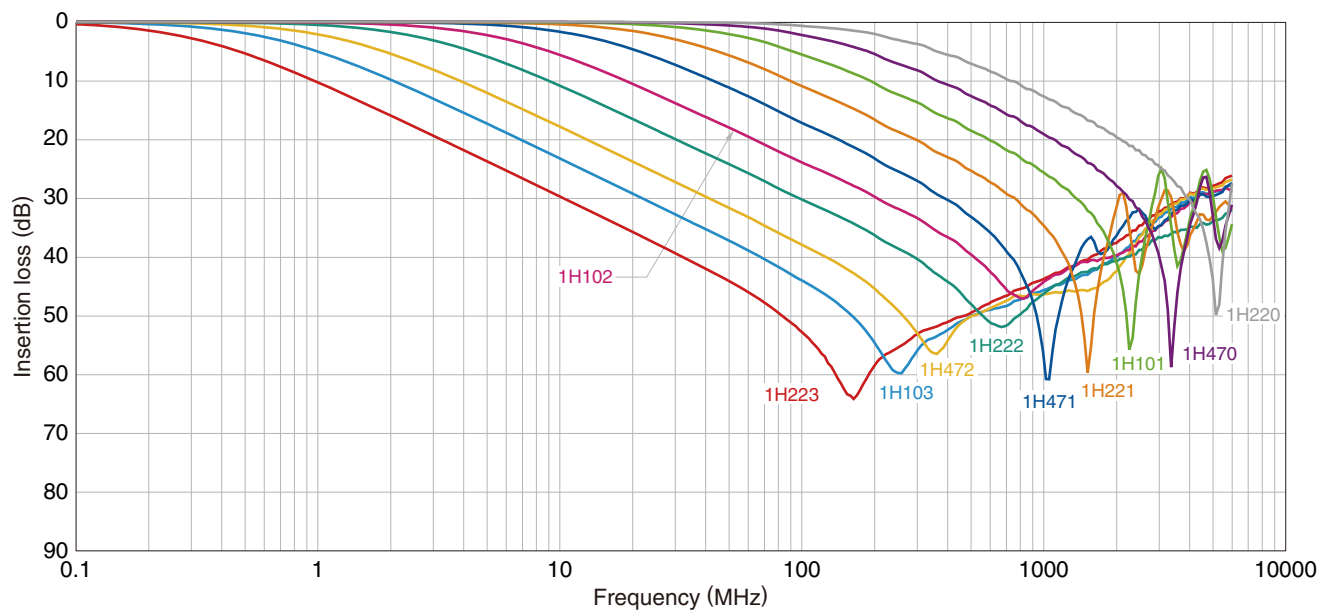

⚠ Please be sure to request delivery specifications that provide further details on the features and specifications of the products for proper and safe use. Please note that the contents may change without any prior notice due to reasons such as upgrading.

YFF-SC Series YFF21SC Type (Feed Through Filter)

SHAPES AND DIMENSIONS

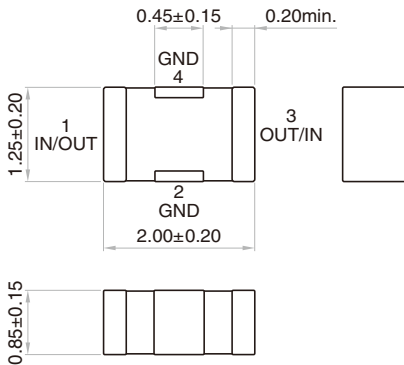

RECOMMENDED LAND PATTERN

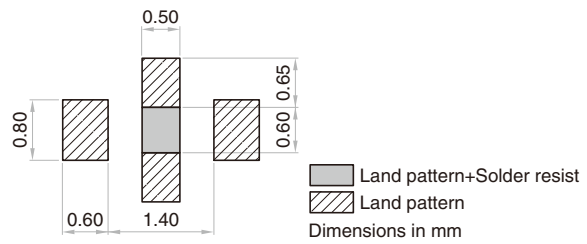

* Make sure to connect the GND terminal of this product and the GND of the mounting circuit board by using through holes so that the distance between them is the shortest.

ELECTRICAL CHARACTERISTICS

CHARACTERISTICS SPECIFICATION TABLE

| Cutoff frequency (MHz) | Insertion loss 30dB bandwidth (MHz) | Rated voltage Edc (V) | Rated current Idc (A) | Operating temperature range (°C) | Storage temperature range(After mount) (°C) | Part No.* |
|------------------------|-------------------------------------|-----------------------|-----------------------|----------------------------------|---|---|
| 0.1 | 5 to 2000 | 50 | 2 | -55 to 125 | -55 to 125 | YFF21SC1H473MT00 <input type="checkbox"/> N |
| 0.1 | 5 to 2000 | 25 | 2 | -55 to 125 | -55 to 125 | YFF21SC1E473MT00 <input type="checkbox"/> N |
| 0.2 | 10 to 2000 | 50 | 2 | -55 to 125 | -55 to 125 | YFF21SC1H223MT00 <input type="checkbox"/> N |
| 0.2 | 10 to 2000 | 25 | 2 | -55 to 125 | -55 to 125 | YFF21SC1E223MT00 <input type="checkbox"/> N |
| 0.5 | 20 to 2000 | 25 | 1 | -55 to 125 | -55 to 125 | YFF21SC1E103MT00 <input type="checkbox"/> N |
| 1 | 40 to 2000 | 50 | 0.4 | -55 to 125 | -55 to 125 | YFF21SC1H472MT00 <input type="checkbox"/> N |
| 2 | 70 to 2000 | 50 | 0.4 | -55 to 125 | -55 to 125 | YFF21SC1H222MT00 <input type="checkbox"/> N |
| 5 | 200 to 2000 | 50 | 0.4 | -55 to 125 | -55 to 125 | YFF21SC1H102MT00 <input type="checkbox"/> N |
| 10 | 400 to 5000 | 50 | 0.4 | -55 to 125 | -55 to 125 | YFF21SC1H471MT00 <input type="checkbox"/> N |
| 20 | 700 to 5000 | 50 | 0.4 | -55 to 125 | -55 to 125 | YFF21SC1H221MT00 <input type="checkbox"/> N |
| 50 | 1000 to 5000 | 50 | 0.4 | -55 to 125 | -55 to 125 | YFF21SC1H101MT00 <input type="checkbox"/> N |
| 100 | 2000 to 5000 | 50 | 0.4 | -55 to 125 | -55 to 125 | YFF21SC1H470MT00 <input type="checkbox"/> N |
| 200 | 3000 to 5000 | 50 | 0.4 | -55 to 125 | -55 to 125 | YFF21SC1H220MT00 <input type="checkbox"/> N |

* The part numbers are TDK's standard specification products.

* : Please specify reel size code, 0 (ø178) or 9 (ø330)

ELECTRICAL CHARACTERISTICS GRAPH

INSERTION LOSS vs. FREQUENCY CHARACTERISTICS

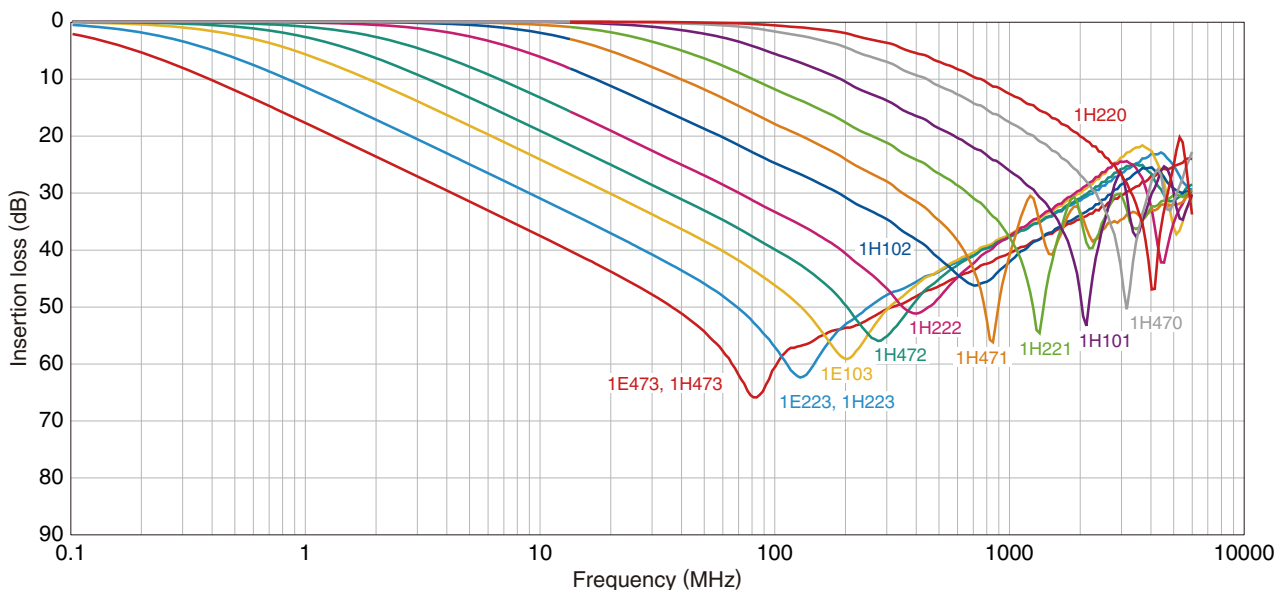

! Please be sure to request delivery specifications that provide further details on the features and specifications of the products for proper and safe use. Please note that the contents may change without any prior notice due to reasons such as upgrading.

YFF-SC Series Packing Style

REEL DIMENSIONS

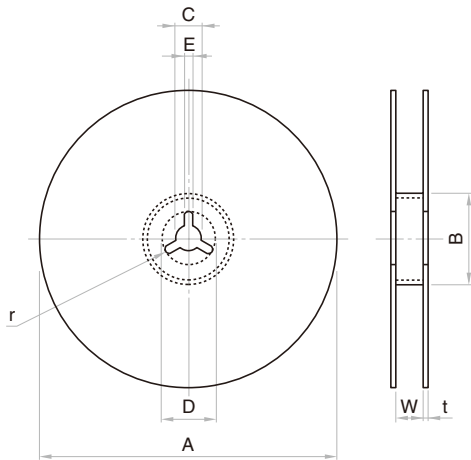

Dimensions in mm

| Reel | A | B | C | D | E | W | t | r |
|------|----------------------|----------|---------|---------|---------|----------|---------|-----|
| ø178 | ø178±2.0 | ø60±2.0 | ø13±0.5 | ø21±0.8 | 2.0±0.5 | 9.0±0.3 | 2.0±0.5 | 1.0 |
| ø330 | ø382 max.(ø330 nom.) | ø50 min. | ø13±0.5 | ø21±0.8 | 2.0±0.5 | 10.0±1.5 | 2.0±0.5 | 1.0 |

TAPE DIMENSIONS

Paper tape

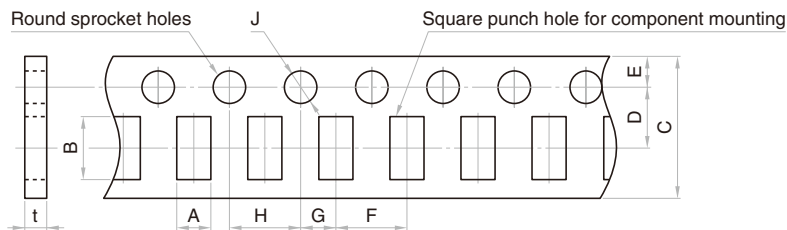

Dimensions in mm

| Type | A | B | C | D | E | F | G | H | J | t |
|---------|-----------|-----------|---------|----------|----------|----------|----------|---------|-------------|----------|
| YFF15SC | 0.62 typ. | 1.12 typ. | 8.0±0.3 | 3.5±0.05 | 1.75±0.1 | 2.0±0.05 | 2.0±0.05 | 4.0±0.1 | ø1.5+0.1/-0 | 0.7 max. |
| YFF18SC | 1.10 typ. | 1.90 typ. | 8.0±0.3 | 3.5±0.05 | 1.75±0.1 | 4.0±0.1 | 2.0±0.05 | 4.0±0.1 | ø1.5+0.1/-0 | 1.1 max. |
| YFF21SC | 1.50 typ. | 2.3 typ. | 8.0±0.3 | 3.5±0.05 | 1.75±0.1 | 4.0±0.1 | 2.0±0.05 | 4.0±0.1 | ø1.5+0.1/-0 | 1.1 max. |

 Please be sure to request delivery specifications that provide further details on the features and specifications of the products for proper and safe use. Please note that the contents may change without any prior notice due to reasons such as upgrading.