



3-terminal Filters

For Power Line

YFF-P Series

| | | |
|---------|-------------------|--|
| YFF15PC | 1005 [0402 inch]* | Feed through filter |
| YFF18PC | 1608 [0603 inch]* | Feed through filter |
| YFF18PH | 1608 [0603 inch]* | Feed through filter (Thickness: 0.8mm) |
| YFF18PW | 1608 [0603 inch]* | Feed through filter (Low ESL) |
| YFF21PC | 2012 [0805 inch]* | Feed through filter |
| YFF31PC | 3216 [1206 inch]* | Feed through filter |

* Dimensions Code JIS[EIA]

3-terminal Filters

Conformity to RoHS Directive
Lead-free Compatible

For Power Line

Overview of YFF-P Series

FEATURES

- Small and high-performance EMC components.
- Good attenuation characteristic in a wide band range.
- For large current (2A to 4A) applications

APPLICATIONS

For the power line of communication terminal devices, such as a smart phone, and AV and information devices.

PART NUMBER IDENTIFICATION

| YFF | | 15 | | PC | | 0G | | 435 | | M | | T | | □□ | | 0 | | N | |
|-------------|----------------|---------|-----------------------|------------------|---------------|-----|-------------|-------------------|-----------|-------------------|--------|-------------------|-----------|------|-----------------------|---|--|---|--|
| Series name | L×W dimensions | | Product internal code | | Rated voltage | | Capacitance | | Tolerance | | Taping | TDK internal code | Reel size | | Internal electrode Ni | | | | |
| | Code | mm | | | Code | V | Code | pF | | ±% | | | Code | mm | | | | | |
| | 15 | 1.0×0.5 | PC | STD | 0G | 4 | 104 | 100,000 | M | ±20% | | | 0 | ø178 | | | | | |
| | 18 | 1.6×0.8 | PH | Thickness: 0.8mm | 0J | 6.3 | 105 | 1,000,000 (1.0μF) | | | | | 9 | ø330 | | | | | |
| | 21 | 2.0×1.2 | PW | Low ESL | 1A | 10 | 225 | 2,200,000 (2.2μF) | | | | | | | | | | | |
| | 31 | 3.2×1.6 | | | 1C | 16 | | | 226 | 22,000,000 (22μF) | | | | | | | | | |
| | | | | | 1E | 25 | | | | | | | | | | | | | |
| | | | | | 1H | 50 | | | | | | | | | | | | | |

PACKAGING STYLE AND SPECIFICATIONS

| Type | Package quantity (piece/reel) | | Single weight (g) |
|---------|-------------------------------|--------|-------------------|
| | ø178 | ø330 | |
| YFF15PC | 10,000 | 50,000 | 0.0008* |
| YFF18PC | 4,000 | 10,000 | 0.0038 |
| YFF18PH | 4,000 | 10,000 | 0.0051 |
| YFF18PW | 4,000 | 10,000 | 0.0038 |
| YFF21PC | 4,000 | 10,000 | 0.0095 |
| YFF31PC | 2,000 | 10,000 | 0.0342 |

* In the case of YFF15PC0G435M, the weight is 0.0015g.

- Conformity to RoHS Directive: This means that, in conformity with EU Directive 2002/95/EC, lead, cadmium, mercury, hexavalent chromium, and specific bromine-based flame retardants, PBB and PBDE, have not been used, except for exempted applications.
- Please contact our Sales office when your application is considered the following:
The device's failure or malfunction may directly endanger human life (e.g. application for automobile/aircraft/medical/nuclear power devices, etc.)

 Please be sure to request delivery specifications that provide further details on the features and specifications of the products for proper and safe use. Please note that the contents may change without any prior notice due to reasons such as upgrading.

Overview of YFF-P Series

RECOMMENDED SOLDERING CONDITION

REFLOW SOLDERING

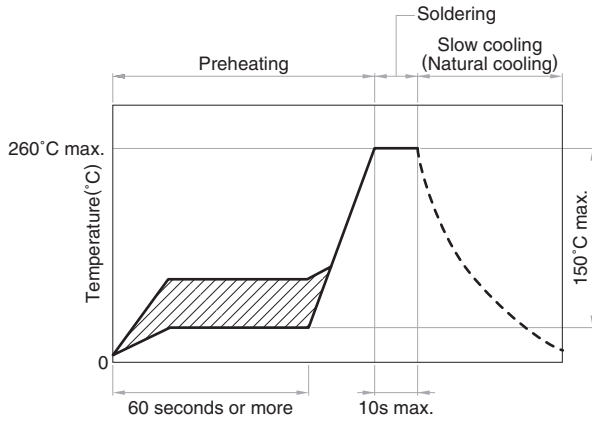

HAND SOLDERING

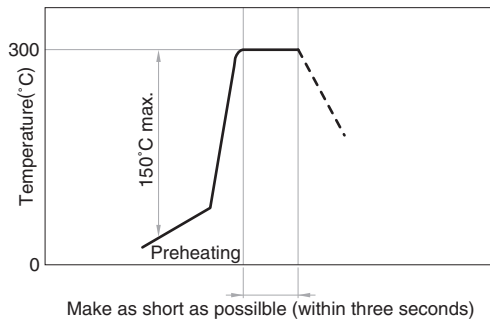

PRECAUTIONS FOR USE

- Before soldering, be sure to preheat components. The ΔT preheating temperature must be 150°C max. with attention paid to thermal shock.
- Natural cooling of components in the air is recommended. On the other hand, when dipping them in a solvent for purposes, such as cleaning, make sure that the temperature difference (ΔT) is 100°C.
- When performing hand soldering for circuit modification, apply the soldering iron to the copper foil area of the printed circuit board for 3 seconds or less. The temperature of the iron tip should not exceed 300°C.
- Use a wrist band to discharge static electricity in your body through the grounding wire.
- When incorporating the printed circuit board on which this product is mounted into a frame, etc., do not apply stress to the product through local bending of the board by tightening of screws, etc.

YFF-P Series YFF15PC Type(Feed Through Filter)

SHAPES AND DIMENSIONS

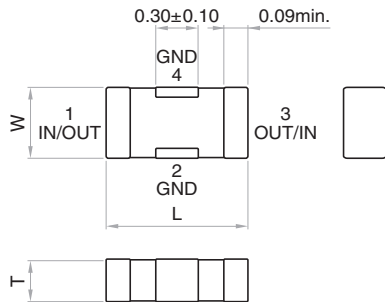

RECOMMENDED LAND PATTERN

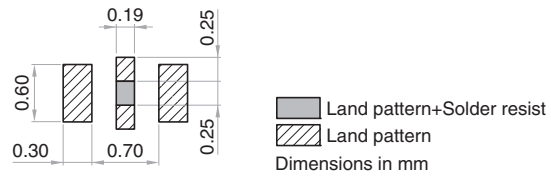

| Part No. | L | W | T |
|--------------------|-----------|-----------|-----------|
| YFF15PC0G435MT00□N | 1.05±0.05 | 0.65±0.05 | 0.45±0.05 |
| YFF15PC0G105MT00□N | 1.00±0.05 | 0.55±0.05 | 0.30±0.05 |
| YFF15PC0J474MT00□N | 1.00±0.05 | 0.55±0.05 | 0.30±0.05 |
| YFF15PC1A224MT00□N | 1.00±0.05 | 0.55±0.05 | 0.30±0.05 |
| YFF15PC1C104MT00□N | 1.00±0.05 | 0.55±0.05 | 0.30±0.05 |

* Make sure to connect the GND terminal of this product and the GND of the mounting circuit board by using through holes so that the distance between them is the shortest.

ELECTRICAL CHARACTERISTICS

CHARACTERISTICS SPECIFICATION TABLE

| Insertion loss 40dB bandwidth (MHz) | Rated voltage Edc (V) | Rated current Idc (A) | Operating temperature range (°C) | Storage temperature range(After mount) (°C) | Part No.* |
|---|-----------------------------|-----------------------------|--|---|--------------------|
| 0.2 to 1000 | 4 | 2 | -55 to 85 | -55 to 85 | YFF15PC0G435MT00□N |
| 0.8 to 1000 | 4 | 3 | -55 to 105 | -55 to 105 | YFF15PC0G105MT00□N |
| 2 to 1000 | 6.3 | 3 | -55 to 105 | -55 to 105 | YFF15PC0J474MT00□N |
| 4 to 1000 | 10 | 3 | -55 to 105 | -55 to 105 | YFF15PC1A224MT00□N |
| 9 to 1000 | 16 | 3 | -55 to 105 | -55 to 105 | YFF15PC1C104MT00□N |

* The part numbers are TDK's standard specification products.

* □: Please specify reel size code, 0 (ø178) or 9 (ø330)

ELECTRICAL CHARACTERISTICS GRAPH

INSERTION LOSS vs. FREQUENCY CHARACTERISTICS

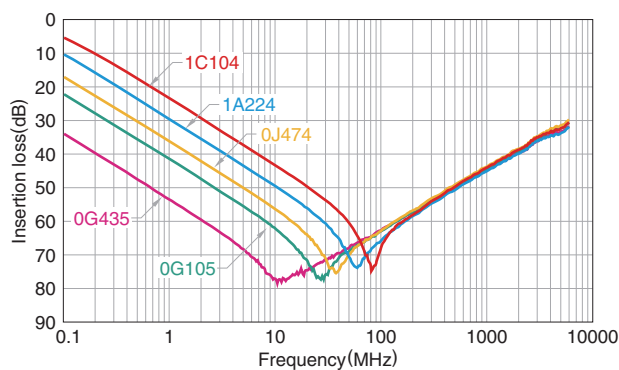

RATED CURRENT vs. TEMPERATURE CHARACTERISTICS (DERATING)

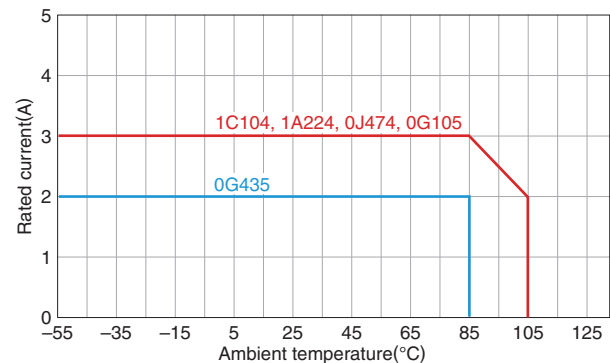

⚠ Please be sure to request delivery specifications that provide further details on the features and specifications of the products for proper and safe use. Please note that the contents may change without any prior notice due to reasons such as upgrading.

YFF-P Series YFF18PC Type(Feed Through Filter)

SHAPES AND DIMENSIONS

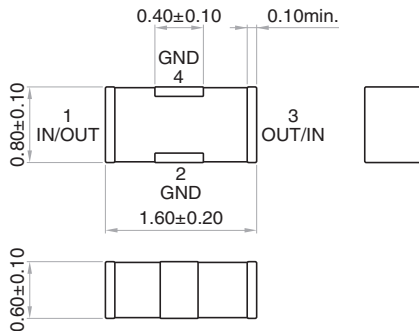

RECOMMENDED LAND PATTERN

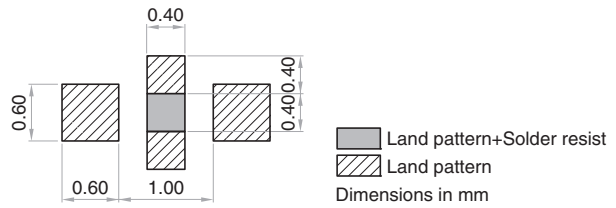

* Make sure to connect the GND terminal of this product and the GND of the mounting circuit board by using through holes so that the distance between them is the shortest.

ELECTRICAL CHARACTERISTICS

CHARACTERISTICS SPECIFICATION TABLE

| Insertion loss 40dB bandwidth (MHz) | Rated voltage Edc (V) | Rated current Idc (A) | Operating temperature range (°C) | Storage temperature range(After mount) (°C) | Part No.* |
|---|-----------------------------|-----------------------------|--|---|--------------------|
| 0.2 to 1000 | 6.3 | 4 | -55 to 85 | -55 to 85 | YFF18PC0J475MT0H□N |
| 0.8 to 1000 | 6.3 | 4 | -55 to 105 | -55 to 105 | YFF18PC0J105MT0H□N |
| 2 to 1000 | 6.3 | 4 | -55 to 125 | -55 to 125 | YFF18PC0J474MT0H□N |
| 3 to 1000 | 6.3 | 4 | -55 to 125 | -55 to 125 | YFF18PC0J224MT0H□N |
| 7 to 1000 | 16 | 4 | -55 to 125 | -55 to 125 | YFF18PC1C104MT0H□N |

* The part numbers are TDK's standard specification products.

* □: Please specify reel size code, 0 (ø178) or 9 (ø330)

ELECTRICAL CHARACTERISTICS GRAPH

INSERTION LOSS vs. FREQUENCY CHARACTERISTICS

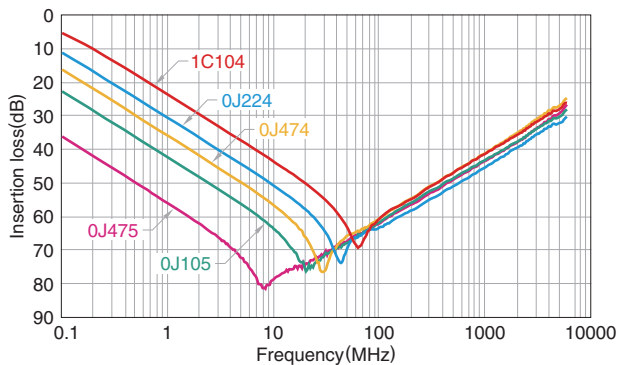

RATED CURRENT vs. TEMPERATURE CHARACTERISTICS (DERATING)

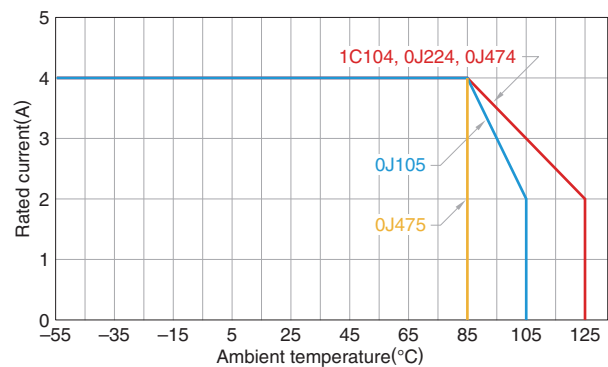

⚠ Please be sure to request delivery specifications that provide further details on the features and specifications of the products for proper and safe use. Please note that the contents may change without any prior notice due to reasons such as upgrading.

YFF-P Series YFF18PH Type(Feed Through Filter)

SHAPES AND DIMENSIONS

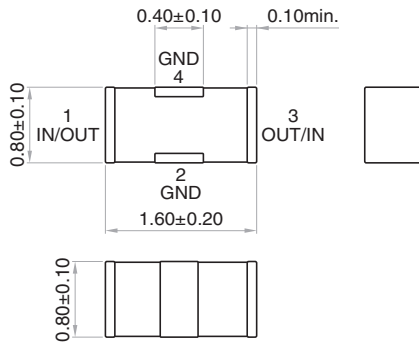

RECOMMENDED LAND PATTERN

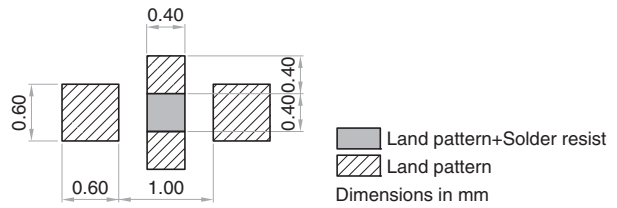

* Make sure to connect the GND terminal of this product and the GND of the mounting circuit board by using through holes so that the distance between them is the shortest.

ELECTRICAL CHARACTERISTICS

CHARACTERISTICS SPECIFICATION TABLE

| Insertion loss 40dB bandwidth (MHz) | Rated voltage E _{dc} (V) | Rated current I _{dc} (A) | Operating temperature range (°C) | Storage temperature range(After mount) (°C) | Part No.* |
|---|---|---|--|---|--------------------|
| 0.4 to 1000 | 6.3 | 4 | -55 to 85 | -55 to 85 | YFF18PH0J225MT00□N |
| 0.8 to 1000 | 6.3 | 4 | -55 to 105 | -55 to 105 | YFF18PH0J105MT00□N |

* The part numbers are TDK's standard specification products.

* □: Please specify reel size code, 0 (ø178) or 9 (ø330)

ELECTRICAL CHARACTERISTICS GRAPH

INSERTION LOSS vs. FREQUENCY CHARACTERISTICS

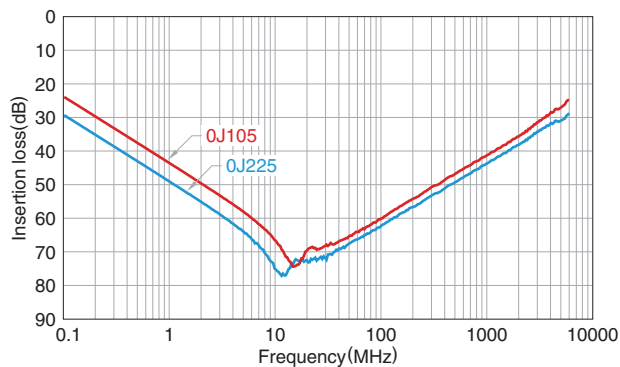

RATED CURRENT vs. TEMPERATURE CHARACTERISTICS (DERATING)

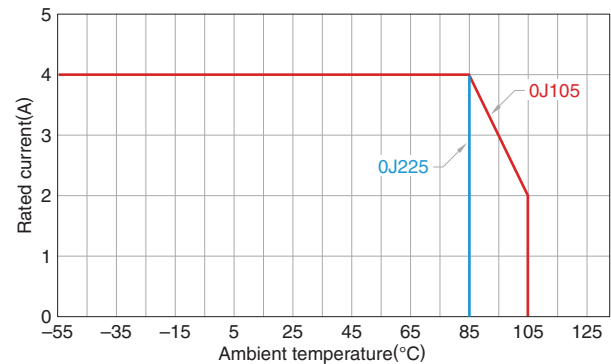

⚠ Please be sure to request delivery specifications that provide further details on the features and specifications of the products for proper and safe use. Please note that the contents may change without any prior notice due to reasons such as upgrading.

YFF-P Series YFF18PW Type(Feed Through Filter)

SHAPES AND DIMENSIONS

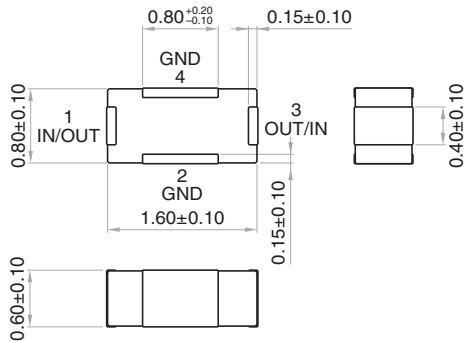

RECOMMENDED LAND PATTERN

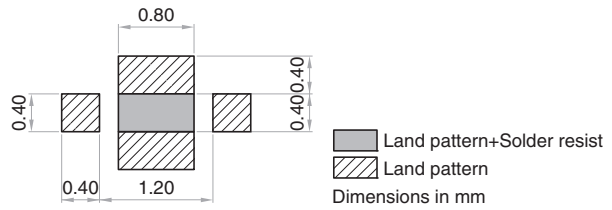

* Make sure to connect the GND terminal of this product and the GND of the mounting circuit board by using through holes so that the distance between them is the shortest.

ELECTRICAL CHARACTERISTICS

CHARACTERISTICS SPECIFICATION TABLE

| Insertion loss 40dB bandwidth (MHz) | Rated voltage E _{dc} (V) | Rated current I _{dc} (A) | Operating temperature range (°C) | Storage temperature range(After mount) (°C) | Part No.* |
|---|---|---|--|---|--------------------|
| 0.2 to 2000 | 6.3 | 4 | -55 to 85 | -55 to 85 | YFF18PW0J475MT0H□N |
| 0.8 to 2000 | 6.3 | 4 | -55 to 105 | -55 to 105 | YFF18PW0J105MT0H□N |
| 2 to 2000 | 6.3 | 4 | -55 to 125 | -55 to 125 | YFF18PW0J474MT0H□N |

* The part numbers are TDK's standard specification products.

* □: Please specify reel size code, 0 (ø178) or 9 (ø330)

ELECTRICAL CHARACTERISTICS GRAPH

INSERTION LOSS vs. FREQUENCY CHARACTERISTICS

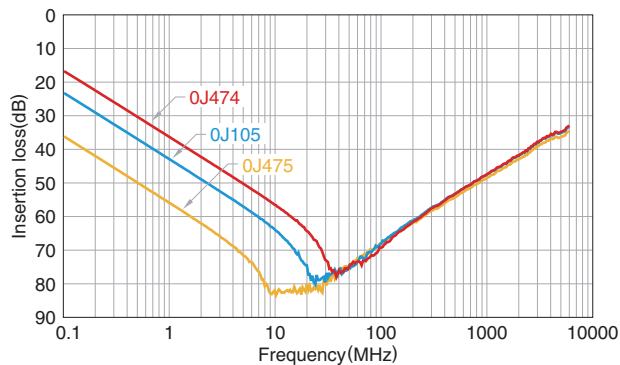

RATED CURRENT vs. TEMPERATURE CHARACTERISTICS (DERATING)

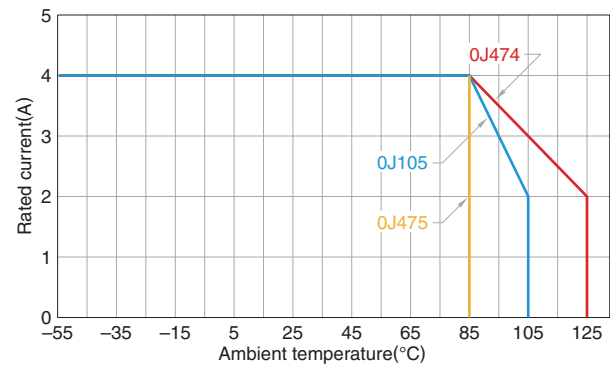

YFF-P Series YFF21PC Type(Feed Through Filter)

SHAPES AND DIMENSIONS

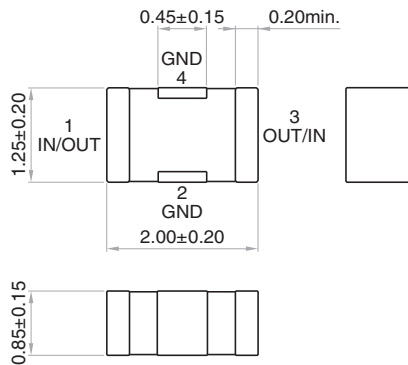

RECOMMENDED LAND PATTERN

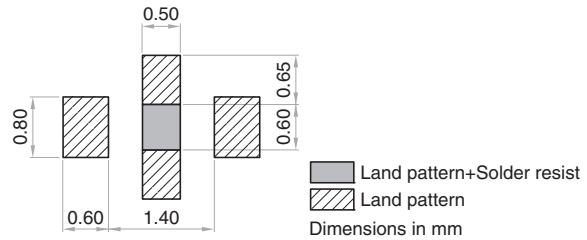

* Make sure to connect the GND terminal of this product and the GND of the mounting circuit board by using through holes so that the distance between them is the shortest.

ELECTRICAL CHARACTERISTICS

CHARACTERISTICS SPECIFICATION TABLE

| Insertion loss 40dB bandwidth (MHz) | Rated voltage Edc (V) | Rated current Idc (A) | Operating temperature range (°C) | Storage temperature range(After mount) (°C) | Part No.* |
|---|-----------------------------|-----------------------------|--|---|--------------------|
| 0.04 to 1000 | 6.3 | 4 | -55 to 85 | -55 to 85 | YFF21PC0J226MT00□N |
| 0.08 to 1000 | 6.3 | 4 | -55 to 85 | -55 to 85 | YFF21PC0J106MT00□N |
| 0.2 to 1000 | 10 | 3 | -55 to 85 | -55 to 85 | YFF21PC1A475MT00□N |
| 0.3 to 1000 | 10 | 2 | -55 to 85 | -55 to 85 | YFF21PC1A225MT00□N |
| 0.7 to 1000 | 10 | 4 | -55 to 85 | -55 to 85 | YFF21PC1A105MT00□N |
| 2 to 1000 | 16 | 2 | -55 to 125 | -55 to 125 | YFF21PC1C474MT00□N |
| 7 to 1000 | 25 | 2 | -55 to 125 | -55 to 125 | YFF21PC1E104MT00□N |

* The part numbers are TDK's standard specification products.

* □: Please specify reel size code, 0 (ø178) or 9 (ø330)

ELECTRICAL CHARACTERISTICS GRAPH

INSERTION LOSS vs. FREQUENCY CHARACTERISTICS

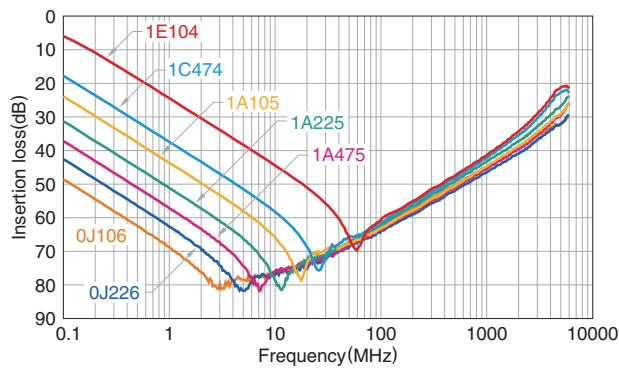

⚠ Please be sure to request delivery specifications that provide further details on the features and specifications of the products for proper and safe use. Please note that the contents may change without any prior notice due to reasons such as upgrading.

YFF-P Series YFF31PC Type(Feed Through Filter)

SHAPES AND DIMENSIONS

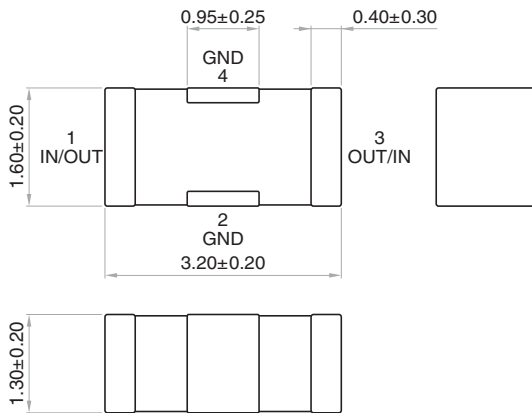

RECOMMENDED LAND PATTERN

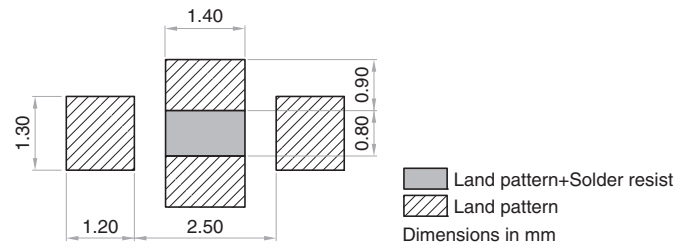

* Make sure to connect the GND terminal of this product and the GND of the mounting circuit board by using through holes so that the distance between them is the shortest.

ELECTRICAL CHARACTERISTICS

CHARACTERISTICS SPECIFICATION TABLE

| Insertion loss 40dB bandwidth (MHz) | Rated voltage E _{dc} (V) | Rated current I _{dc} (A) | Operating temperature range (°C) | Storage temperature range(After mount) (°C) | Part No.* |
|---|---|---|--|---|--------------------|
| 0.04 to 1000 | 6.3 | 4 | -55 to 85 | -55 to 85 | YFF31PC0J226MT00□N |
| 0.7 to 1000 | 16 | 2 | -55 to 125 | -55 to 125 | YFF31PC1C105MT00□N |
| 2 to 1000 | 16 | 2 | -55 to 125 | -55 to 125 | YFF31PC1C474MT00□N |
| 3 to 600 | 16 | 2 | -55 to 125 | -55 to 125 | YFF31PC1C224MT00□N |
| 7 to 1000 | 16 | 2 | -55 to 125 | -55 to 125 | YFF31PC1C104MT00□N |

* The part numbers are TDK's standard specification products.

* □: Please specify reel size code, 0 (ø178) or 9 (ø330)

ELECTRICAL CHARACTERISTICS GRAPH

INSERTION LOSS vs. FREQUENCY CHARACTERISTICS

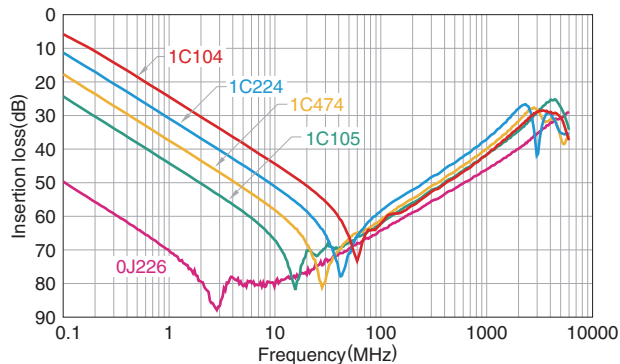

YFF-P Series Packing Style

REEL DIMENSIONS

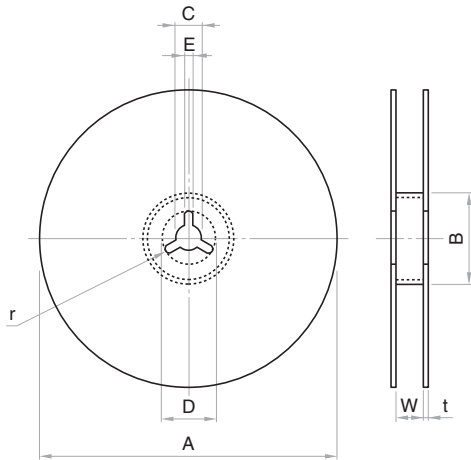

Dimensions in mm

| Reel | A | B | C | D | E | W | t | r |
|------|----------------------|----------|---------|---------|---------|----------|----------|-----|
| ø178 | ø178±2.0 | ø60±2.0 | ø13±0.5 | ø21±0.8 | 2.0±0.5 | 9.0±0.3 | 2.0±0.05 | 1.0 |
| ø330 | ø382 max.(ø330 nom.) | ø50 min. | ø13±0.5 | ø21±0.8 | 2.0±0.5 | 10.0±1.5 | 2.0±0.05 | 1.0 |

TAPE DIMENSIONS

Paper tape

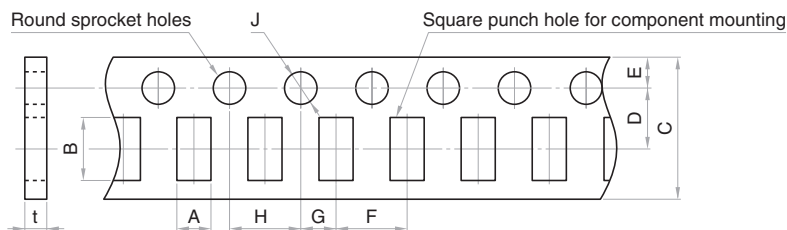

Dimensions in mm

| Type | A | B | C | D | E | F | G | H | J | t |
|---------|---------------------------|---------------------------|---------|----------|----------|----------|----------|---------|-------------|----------|
| YFF15PC | 0.62 typ. (0.75 typ.)* | 1.12 typ. (1.18 typ.)* | 8.0±0.3 | 3.5±0.05 | 1.75±0.1 | 2.0±0.05 | 2.0±0.05 | 4.0±0.1 | ø1.5+0.1/-0 | 0.7 max. |
| YFF18PC | | | | | | | | | | |
| YFF18PH | 1.10 typ. | 1.90 typ. | 8.0±0.3 | 3.5±0.05 | 1.75±0.1 | 4.0±0.1 | 2.0±0.05 | 4.0±0.1 | ø1.5+0.1/-0 | 1.1 max. |
| YFF18PW | | | | | | | | | | |
| YFF21PC | 1.50 typ. | 2.30 typ. | 8.0±0.3 | 3.5±0.05 | 1.75±0.1 | 4.0±0.1 | 2.0±0.05 | 4.0±0.1 | ø1.5+0.1/-0 | 1.1 max. |

* Applies to YFF15PC0G435M

Plastic tape

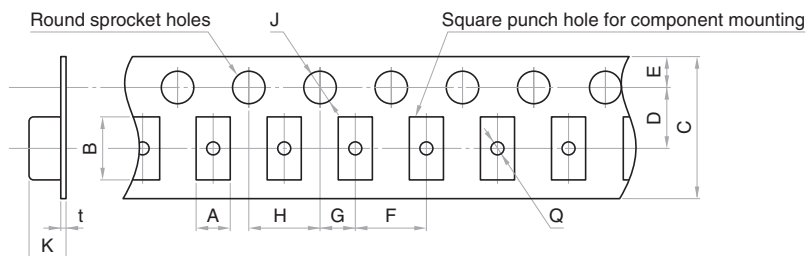

Dimensions in mm

| Type | A | B | C | D | E | F | G | H | J | K | t | Q |
|---------|-----------|-----------|---------|----------|----------|----------|----------|----------|-------------|-----------|-----------|------------|
| YFF31PC | 1.90 typ. | 3.50 typ. | 8.0±0.3 | 3.5±0.05 | 1.75±0.1 | 4.00±0.1 | 2.0±0.05 | 4.00±0.1 | ø1.5+0.1/-0 | 2.50 max. | 0.30 max. | ø0.50 max. |

Please be sure to request delivery specifications that provide further details on the features and specifications of the products for proper and safe use. Please note that the contents may change without any prior notice due to reasons such as upgrading.