



# Chip Beads

For general signal line

## MMZ series (For automobiles)

---

<b>MMZ1005</b>	<b>1005[0402 inch]*</b>
<b>MMZ1608</b>	<b>1608[0603 inch]</b>
<b>MMZ2012</b>	<b>2012[0805 inch]</b>

\* Dimensions Code JIS[EIA]

---

## REMINDERS FOR USING THESE PRODUCTS

Before using these products, be sure to request the delivery specifications.

### SAFETY REMINDERS

Please pay sufficient attention to the warnings for safe designing when using these products.

#### REMINDERS

- The storage period is less than 12 months. Be sure to follow the storage conditions (Temperature: 5 to 40°C, Humidity: 10 to 75% RH or less).  
If the storage period elapses, the soldering of the terminal electrodes may deteriorate.
- Do not use or store in locations where there are conditions such as gas corrosion (salt, acid, alkali, etc.).
- Before soldering, be sure to preheat components.  
The preheating temperature should be set so that the temperature difference between the solder temperature and chip temperature does not exceed 150°C.
- Soldering corrections after mounting should be within the range of the conditions determined in the specifications.  
If overheated, a short circuit, performance deterioration, or lifespan shortening may occur.
- When embedding a printed circuit board where a chip is mounted to a set, be sure that residual stress is not given to the chip due to the overall distortion of the printed circuit board and partial distortion such as at screw tightening portions.
- Self heating (temperature increase) occurs when the power is turned ON, so the tolerance should be sufficient for the set thermal design.
- Carefully lay out the coil for the circuit board design of the non-magnetic shield type.  
A malfunction may occur due to magnetic interference.
- Use a wrist band to discharge static electricity in your body through the grounding wire.
- Do not expose the products to magnets or magnetic fields.
- Do not use for a purpose outside of the contents regulated in the delivery specifications.
- The products listed on this catalog are intended for use in general electronic equipment (AV equipment, telecommunications equipment, home appliances, amusement equipment, computer equipment, personal equipment, office equipment, measurement equipment, industrial robots) under a normal operation and use condition.  
The products are not designed or warranted to meet the requirements of the applications listed below, whose performance and/or quality require a more stringent level of safety or reliability, or whose failure, malfunction or trouble could cause serious damage to society, person or property.  
If you intend to use the products in the applications listed below or if you have special requirements exceeding the range or conditions set forth in the each catalog, please contact us.

- (1) Aerospace/Aviation equipment
- (2) Transportation equipment (electric trains, ships, etc.)
- (3) Medical equipment
- (4) Power-generation control equipment
- (5) Atomic energy-related equipment
- (6) Seabed equipment
- (7) Transportation control equipment

- (8) Public information-processing equipment
- (9) Military equipment
- (10) Electric heating apparatus, burning equipment
- (11) Disaster prevention/crime prevention equipment
- (12) Safety equipment
- (13) Other applications that are not considered general-purpose applications

When designing your equipment even for general-purpose applications, you are kindly requested to take into consideration securing protection circuit/device or providing backup circuits in your equipment.

# Chip Beads

## For general signal line

Product compatible with RoHS directive  
Halogen-free  
Compatible with lead-free solders  
AEC-Q200

# Overview of the MMZ Series

## FEATURES

- Noise reduction solution for general signal line.
- Lineup includes 3 sizes from 1005 to 2012.
- Various frequency characteristics with 8 materials of different features for countermeasures against everything from general signals to high-speed signals.

## APPLICATION

Various ECUs, powertrains, body controls, and car multimedia (telematics).

## PART NUMBER CONSTRUCTION

MMZ	1005	S	121	C	T	D25		
Series name	LxWxT Dimensions (mm)		Material name	Impedance ( $\Omega$ ) at 100MHz		Characteristic type	Packaging style	Internal code
1005	1.0x0.5x0.5	A	121	120	C	T	Taping	D25
1608	1.6x0.8x0.6	B			A			DH5
	1.6x0.8x0.8	D			B			
2012	2.0x1.25x0.85	F			H			
		Q						
		R						
		S						
		Y						

## OPERATING TEMPERATURE RANGE, PACKAGE QUANTITY, PRODUCT WEIGHT

Type	Temperature range		Package quantity (pieces/reel)	Individual weight (mg)	
	Operating temperature ( $^{\circ}\text{C}$ )	Storage temperature* ( $^{\circ}\text{C}$ )			
	MMZ1005	-55 to +125			-55 to +125
MMZ1608	t=0.6mm	-55 to +125	-55 to +125	4,000	3
	t=0.8mm	-55 to +125	-55 to +125	4,000	4
MMZ2012	-55 to +125	-55 to +125	4,000	8	

\* The Storage temperature range is for after the circuit board is mounted.

- RoHS Directive Compliant Product: See the following for more details related to RoHS Directive compliant products. <http://www.tdk.co.jp/rohs/>
- Halogen-free: Indicates that Cl content is less than 900ppm, Br content is less than 900ppm, and that the total Cl and Br content is less than 1500ppm.

• All specifications are subject to change without notice.

# Overview of the MMZ Series

## RECOMMENDED REFLOW PROFILE



Preheating			Soldering		Peak	
Temp.	Temp.	Time	Temp.	Time	Temp.	Time
T1	T2	t1	T3	t2	T4	t3
150°C	180°C	60 to 120s	230°C	30 to 60s	250 to 260°C	10s

# Overview of the MMZ Series

## MATERIAL CHARACTERISTICS

- B material:** This type is perfectly suited for fast digital signals. By equalizing R components and X components that beads possess at a frequency of 5MHz, it is able to suppress overshooting, undershooting and ringing of fast digital signals.
- R material:** For wide frequency applications calling for broad impedance characteristics. For digital signal line applications calling requiring good waveform integrity. Impedance values selected for effectiveness at 10 to 200MHz.
- S material:** Standard type that features impedance characteristics similar to those of a typical ferrite core. For signal line applications in which the blocking region is near 100MHz. Impedance values selected for effectiveness at 40 to 300MHz.
- Y material:** High frequency range type intended for the 100MHz region and above.  
For signal line applications in which the signal frequency is far from the cutoff frequency. Impedance values selected for effectiveness at 80 to 400MHz.
- A material:** This high-impedance product is based on the impedance frequency characteristics of our Y-material. The product offers excellent impedance characteristics, which is greater than  $2500\Omega$ , in the vicinity of 100MHz range (MMZ1608A252B).
- Q material:** For high-band applications designed for 100MHz and above. Impedance values selected for effectiveness at 100 to 800MHz.
- D material:** For applications calling for low insertion loss at low frequencies and sharply increasing impedance at high frequencies. Designed for high impedance at high frequencies (300MHz to 1GHz) for signal line applications.
- F material:** This new product inherits the characteristic of our D-material, namely its sharp impedance rise time, and its impedance peak frequency has been shifted higher into range. The product offers excellent noise suppression from 600MHz to as high as in the GHz range.

## TYPICAL MATERIAL IMPEDANCE CHARACTERISTICS

### MMZ1005 Type

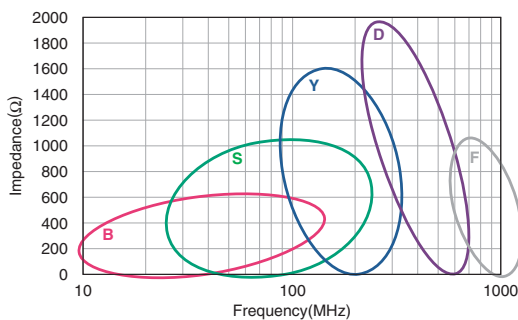

### MMZ2012 Type

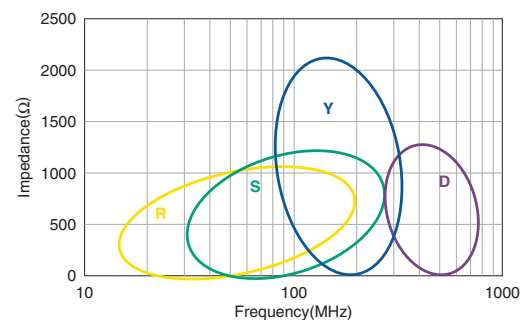

### MMZ1608 Type

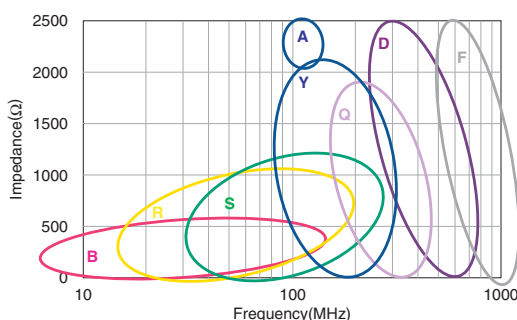

MMZ series

# MMZ1005 Type



## SHAPE & DIMENSIONS

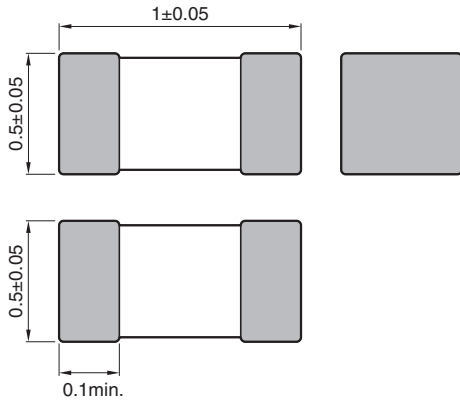

## RECOMMENDED LAND PATTERN

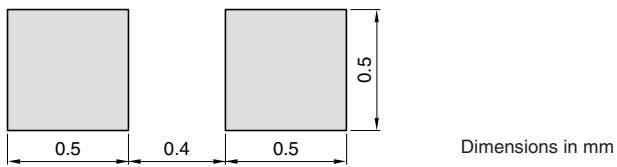

• All specifications are subject to change without notice.

# MMZ series MMZ1005 Type

## ELECTRICAL CHARACTERISTICS

### CHARACTERISTICS SPECIFICATION TABLE

Impedance [100MHz] ( $\Omega$ )	Tolerance	DC resistance ( $\Omega$ )max.	Rated current (mA)max.	Part No.
80	$\pm 25\%$	0.19	450	MMZ1005B800CTD25
120	$\pm 25\%$	0.25	400	MMZ1005B121CTD25
600	$\pm 25\%$	0.85	200	MMZ1005B601CTD25
80	$\pm 25\%$	0.12	500	MMZ1005S800CTD25
120	$\pm 25\%$	0.22	500	MMZ1005S121CTD25
240	$\pm 25\%$	0.28	400	MMZ1005S241CTD25
600	$\pm 25\%$	0.52	300	MMZ1005S601CTD25
1000	$\pm 25\%$	0.75	200	MMZ1005S102CTD25
40	$\pm 25\%$	0.10	550	MMZ1005Y400CTD25
80	$\pm 25\%$	0.17	450	MMZ1005Y800CTD25
120	$\pm 25\%$	0.18	400	MMZ1005Y121CTD25
240	$\pm 25\%$	0.26	300	MMZ1005Y241CTD25
300	$\pm 25\%$	0.38	250	MMZ1005Y301CTD25
470	$\pm 25\%$	0.47	250	MMZ1005Y471CTD25
600	$\pm 25\%$	0.54	250	MMZ1005Y601CTD25
1000	$\pm 25\%$	0.70	200	MMZ1005Y102CTD25
1500	$\pm 25\%$	1.00	100	MMZ1005Y152CTD25
1800	$\pm 25\%$	0.85	150	MMZ1005Y182CTD25
10	$\pm 5\Omega$	0.10	500	MMZ1005D100CTD25
22	$\pm 25\%$	0.17	400	MMZ1005D220CTD25
33	$\pm 25\%$	0.24	400	MMZ1005D330CTD25
68	$\pm 25\%$	0.38	400	MMZ1005D680CTD25
120	$\pm 25\%$	0.60	350	MMZ1005D121CTD25
240	$\pm 25\%$	0.90	200	MMZ1005D241CTD25
33	$\pm 25\%$	0.50	200	MMZ1005F330CTD25
47	$\pm 25\%$	0.60	100	MMZ1005F470CTD25
56	$\pm 25\%$	0.70	100	MMZ1005F560CTD25

### Measurement equipment

Measurement item	Product No.	Manufacturer
Impedance	E4991A+16192A	Agilent Technologies
DC resistance	Type-7556	Yokogawa

\* Equivalent measurement equipment may be used.

# MMZ series MMZ1005 Type

## ELECTRICAL CHARACTERISTICS

### Z VS. FREQUENCY CHARACTERISTICS (BY SERIES)

MMZ1005B SERIES

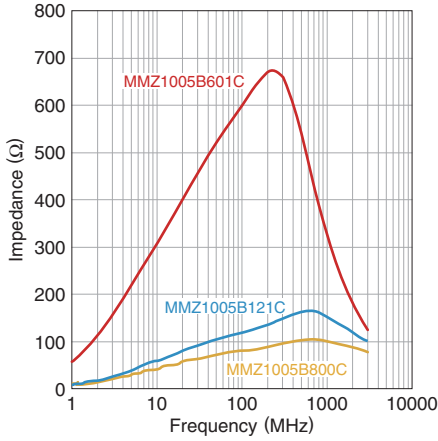

MMZ1005S SERIES

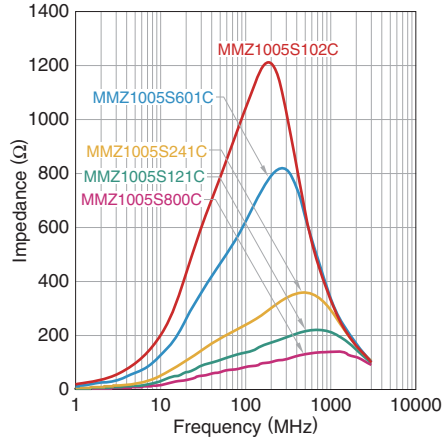

MMZ1005Y SERIES

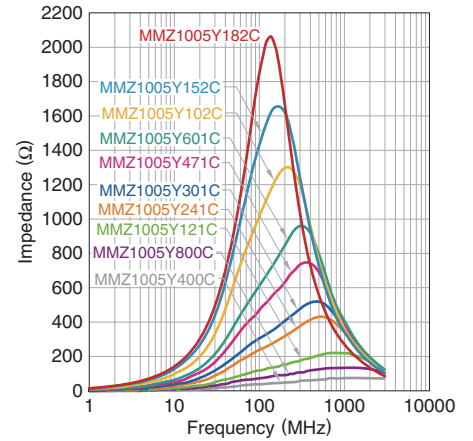

MMZ1005D SERIES

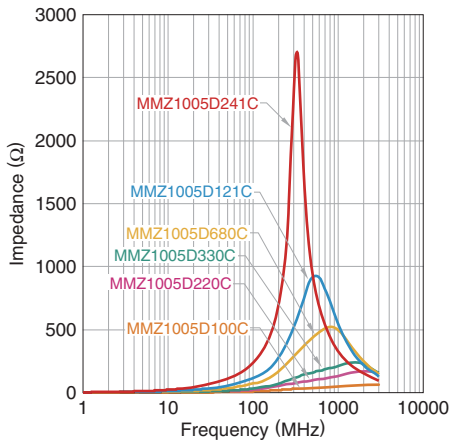

MMZ1005F SERIES

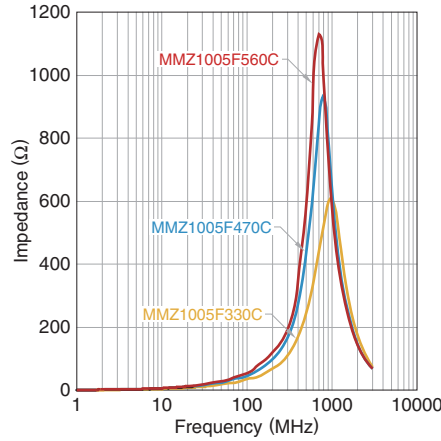

• All specifications are subject to change without notice.



# MMZ series MMZ1005 Type

## ELECTRICAL CHARACTERISTICS

### Z, X, R VS. FREQUENCY CHARACTERISTICS

MMZ1005B800CTD25

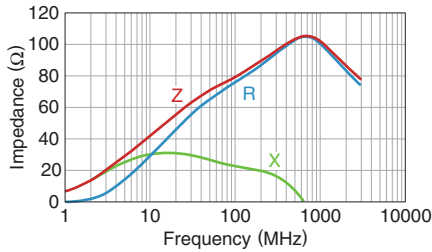

MMZ1005B121CTD25

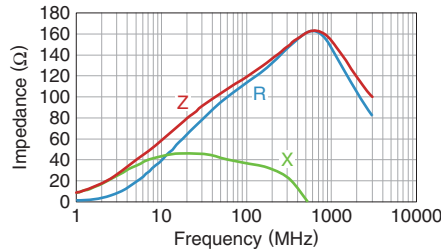

MMZ1005B601CTD25

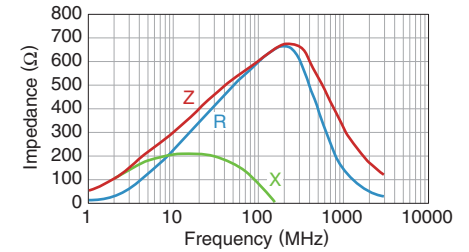

MMZ1005S800CTD25

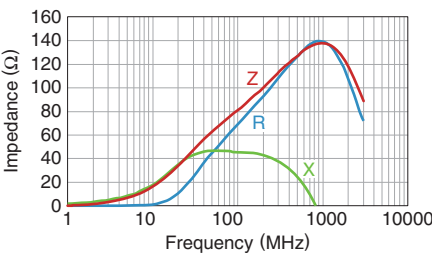

MMZ1005S121CTD25

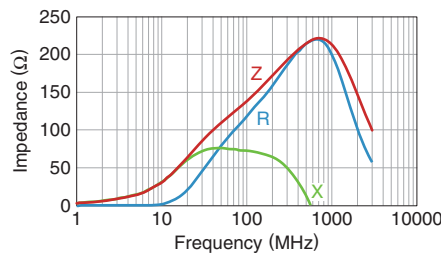

MMZ1005S241CTD25

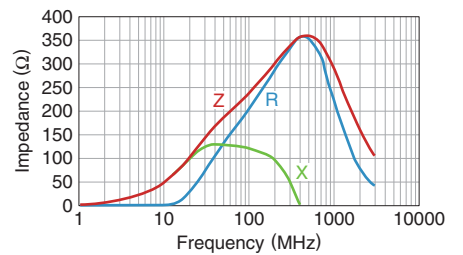

MMZ1005S601CTD25

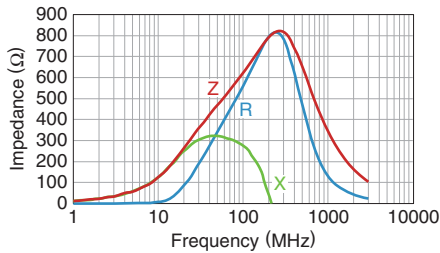

MMZ1005S102CTD25

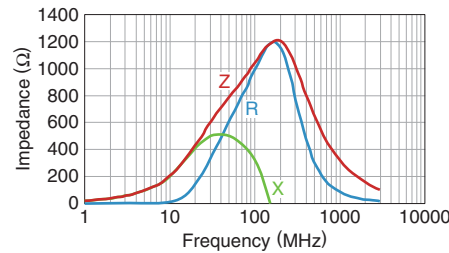

MMZ1005Y400CTD25

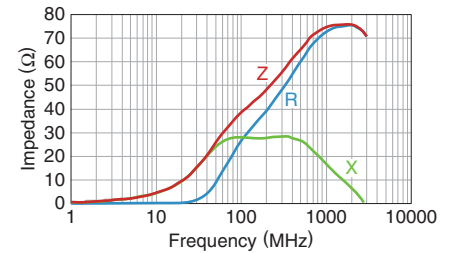

MMZ1005Y800CTD25

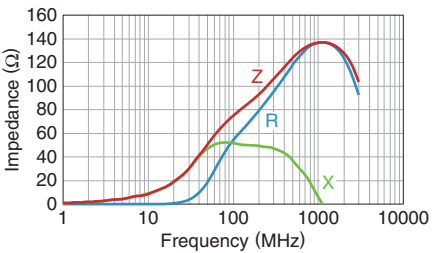

MMZ1005Y121CTD25

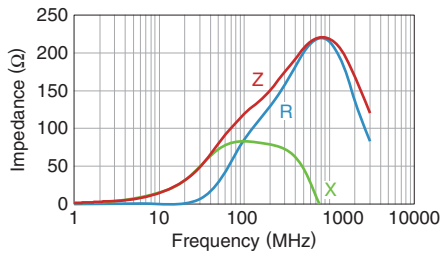

MMZ1005Y241CTD25

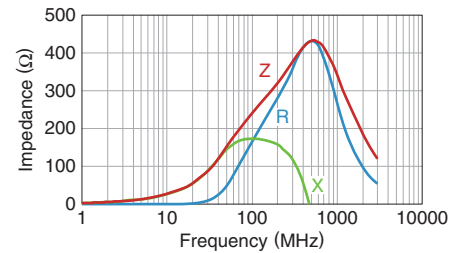

MMZ1005Y301CTD25

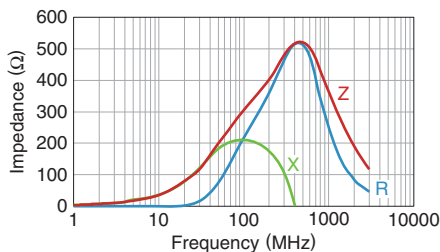

MMZ1005Y471CTD25

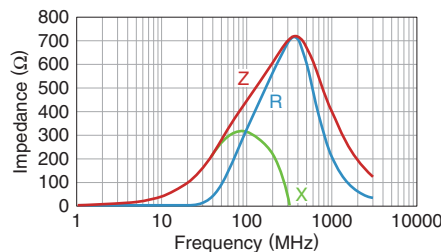

MMZ1005Y601CTD25

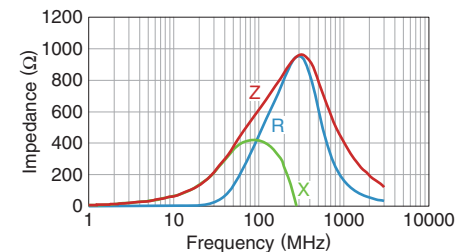

• All specifications are subject to change without notice.

# MMZ series MMZ1005 Type

## ELECTRICAL CHARACTERISTICS

### Z, X, R VS. FREQUENCY CHARACTERISTICS

MMZ1005Y102CTD25

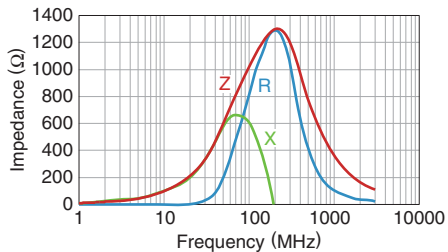

MMZ1005Y152CTD25

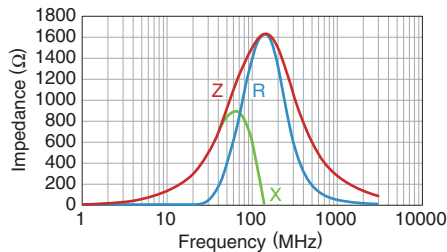

MMZ1005Y182CTD25

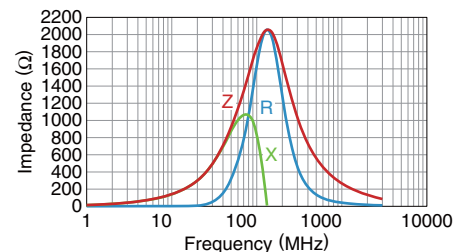

MMZ1005D100CTD25

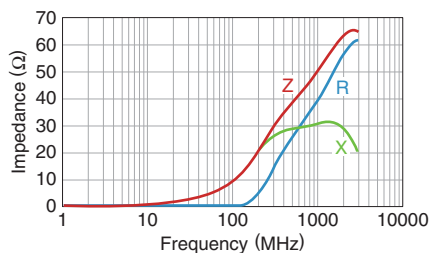

MMZ1005D220CTD25

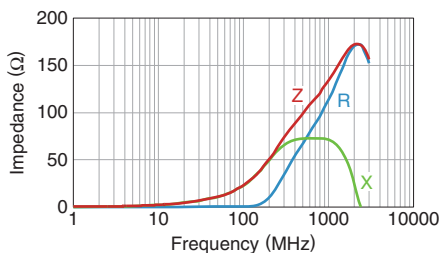

MMZ1005D330CTD25

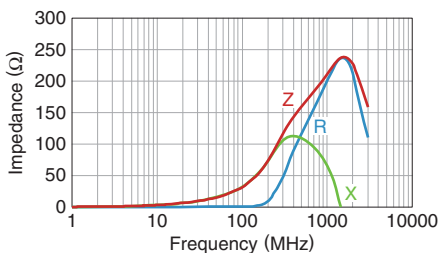

MMZ1005D680CTD25

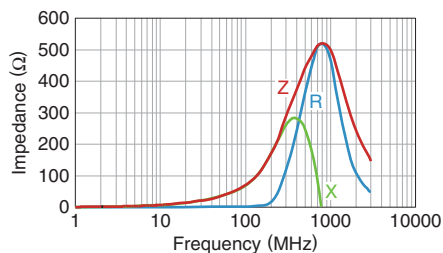

MMZ1005D121CTD25

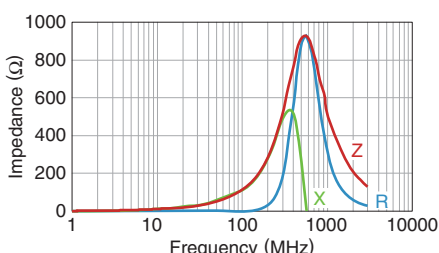

MMZ1005D241CTD25

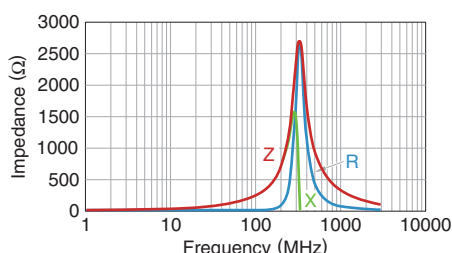

MMZ1005F330CTD25

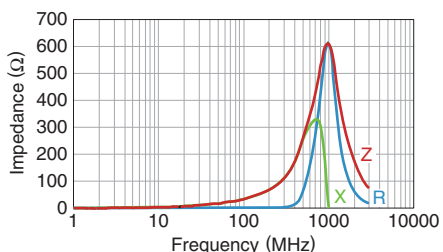

MMZ1005F470CTD25

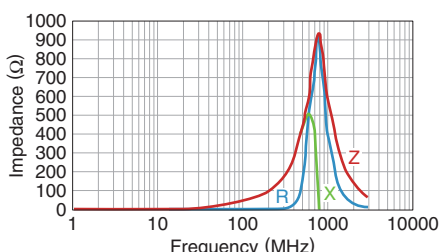

MMZ1005F560CTD25

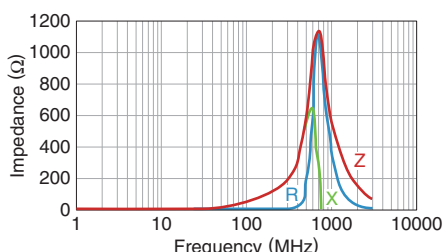

• All specifications are subject to change without notice.

MMZ series

# MMZ1608 Type



## SHAPE & DIMENSIONS

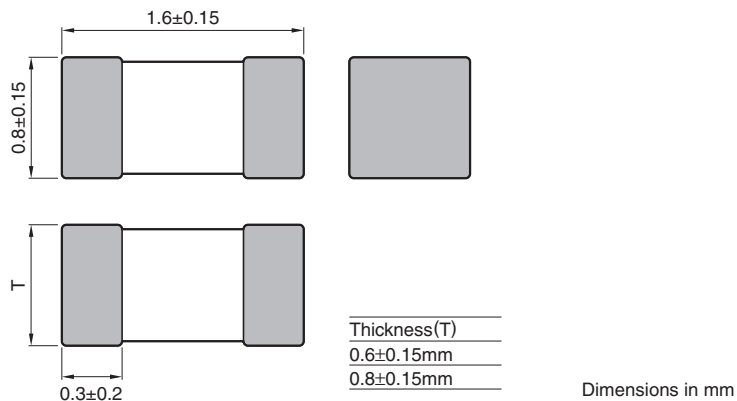

## RECOMMENDED LAND PATTERN

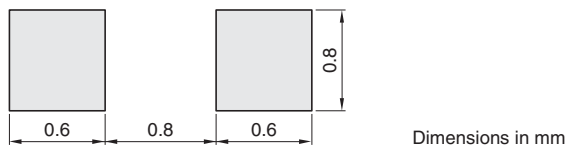

• All specifications are subject to change without notice.

# MMZ series MMZ1608 Type

## ELECTRICAL CHARACTERISTICS

### CHARACTERISTICS SPECIFICATION TABLE

Impedance [100MHz] ( $\Omega$ )	Tolerance	DC resistance ( $\Omega$ )max.	Rated current (mA)max.	Thickness T (mm)	Part No.
120	$\pm 25\%$	0.15	600	0.6	MMZ1608B121CTDH5
220	$\pm 25\%$	0.25	500	0.6	MMZ1608B221CTDH5
300	$\pm 25\%$	0.25	500	0.6	MMZ1608B301CTDH5
470	$\pm 25\%$	0.30	500	0.6	MMZ1608B471CTDH5
600	$\pm 25\%$	0.40	500	0.6	MMZ1608B601CTDH5
1000	$\pm 25\%$	0.60	300	0.8	MMZ1608B102CTD25
15	$\pm 25\%$	0.05	1500	0.8	MMZ1608R150ATD25
30	$\pm 25\%$	0.05	1500	0.8	MMZ1608R300ATD25
60	$\pm 25\%$	0.10	800	0.8	MMZ1608R600ATD25
120	$\pm 25\%$	0.18	500	0.8	MMZ1608R121ATD25
300	$\pm 25\%$	0.25	500	0.8	MMZ1608R301ATD25
470	$\pm 25\%$	0.30	500	0.8	MMZ1608R471ATD25
600	$\pm 25\%$	0.40	500	0.8	MMZ1608R601ATD25
1000	$\pm 25\%$	0.50	400	0.8	MMZ1608R102ATD25
40	$\pm 25\%$	0.10	600	0.8	MMZ1608S400ATD25
80	$\pm 25\%$	0.15	500	0.8	MMZ1608S800ATD25
120	$\pm 25\%$	0.15	500	0.8	MMZ1608S121ATD25
180	$\pm 25\%$	0.20	500	0.8	MMZ1608S181ATD25
220	$\pm 25\%$	0.20	500	0.8	MMZ1608S221ATD25
300	$\pm 25\%$	0.30	500	0.8	MMZ1608S301ATD25
470	$\pm 25\%$	0.30	500	0.8	MMZ1608S471ATD25
600	$\pm 25\%$	0.35	500	0.8	MMZ1608S601ATD25
1000	$\pm 25\%$	0.50	400	0.8	MMZ1608S102ATD25
2000	$\pm 25\%$	0.90	200	0.8	MMZ1608S202ATD25
15	$\pm 25\%$	0.05	1500	0.8	MMZ1608Y150BTD25
30	$\pm 25\%$	0.05	1500	0.8	MMZ1608Y300BTD25
60	$\pm 25\%$	0.15	500	0.8	MMZ1608Y600BTD25
120	$\pm 25\%$	0.20	500	0.8	MMZ1608Y121BTD25
220	$\pm 25\%$	0.30	500	0.8	MMZ1608Y221BTD25
300	$\pm 25\%$	0.30	500	0.8	MMZ1608Y301BTD25
470	$\pm 25\%$	0.35	500	0.8	MMZ1608Y471BTD25
600	$\pm 25\%$	0.40	500	0.8	MMZ1608Y601BTD25
750	$\pm 25\%$	0.45	500	0.8	MMZ1608Y751BTD25
1000	$\pm 25\%$	0.50	400	0.8	MMZ1608Y102BTD25
1500	$\pm 25\%$	0.60	300	0.8	MMZ1608Y152BTD25
1800	$\pm 25\%$	0.80	200	0.8	MMZ1608A182BTD25
2200	$\pm 25\%$	0.80	200	0.8	MMZ1608A222BTD25
2500	$\pm 25\%$	0.80	200	0.8	MMZ1608A252BTD25
120	$\pm 25\%$	0.30	500	0.8	MMZ1608Q121BTD25
220	$\pm 25\%$	0.40	500	0.8	MMZ1608Q221BTD25
330	$\pm 25\%$	0.50	400	0.8	MMZ1608Q331BTD25
470	$\pm 25\%$	0.70	300	0.8	MMZ1608Q471BTD25
600	$\pm 25\%$	0.80	200	0.8	MMZ1608Q601BTD25
1000	$\pm 25\%$	1.00	200	0.8	MMZ1608Q102BTD25

#### Measurement equipment

Measurement item	Product No.	Manufacturer
Impedance	E4991A+16192A	Agilent Technologies
DC resistance	Type-7556	Yokogawa

\* Equivalent measurement equipment may be used.

# MMZ series **MMZ1608 Type**

## ■ ELECTRICAL CHARACTERISTICS

### □ CHARACTERISTICS SPECIFICATION TABLE

Impedance [100MHz] ( $\Omega$ )	Tolerance	DC resistance ( $\Omega$ )max.	Rated current (mA)max.	Thickness T (mm)	Part No.
5	$\pm 2\Omega$	0.05	700	0.8	MMZ1608D050CTD25
10	$\pm 5\Omega$	0.10	500	0.6	MMZ1608D100CTDH5
22	$\pm 25\%$	0.20	500	0.6	MMZ1608D220CTDH5
50	$\pm 25\%$	0.25	500	0.6	MMZ1608D500CTDH5
80	$\pm 25\%$	0.30	500	0.6	MMZ1608D800CTDH5
80	$\pm 25\%$	0.30	500	0.8	MMZ1608D800BTD25
120	$\pm 25\%$	0.30	400	0.6	MMZ1608D121CTDH5
120	$\pm 25\%$	0.30	400	0.8	MMZ1608D121BTD25
240	$\pm 25\%$	0.60	300	0.8	MMZ1608D241CTD25
300	$\pm 25\%$	0.70	300	0.8	MMZ1608D301BTD25
3typ.		0.05	700	0.8	MMZ1608F030BTD25
47	$\pm 25\%$	0.40	500	0.8	MMZ1608F470BTD25
75	$\pm 25\%$	0.55	300	0.8	MMZ1608F750BTD25
120	$\pm 25\%$	0.75	200	0.8	MMZ1608F121BTD25

### ○ Measurement equipment

Measurement item	Product No.	Manufacturer
Impedance	E4991A+16192A	Agilent Technologies
DC resistance	Type-7556	Yokogawa

\* Equivalent measurement equipment may be used.

# MMZ series MMZ1608 Type

## ELECTRICAL CHARACTERISTICS

### Z VS. FREQUENCY CHARACTERISTICS (BY SERIES)

MMZ1608B SERIES

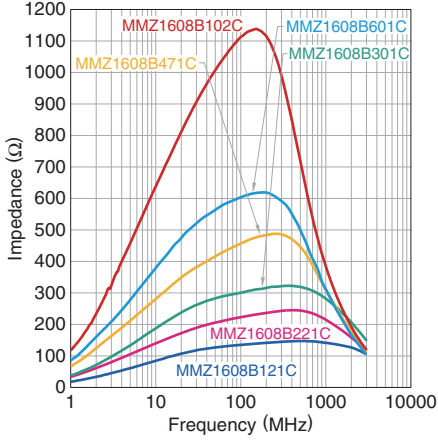

MMZ1608R SERIES

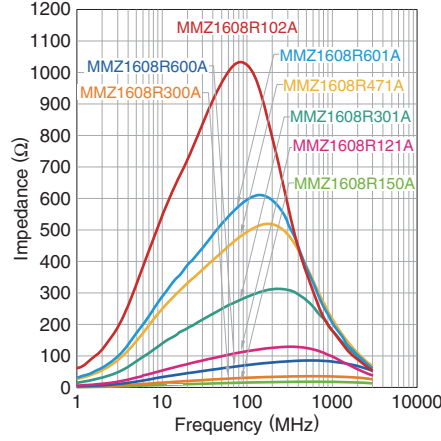

MMZ1608S SERIES

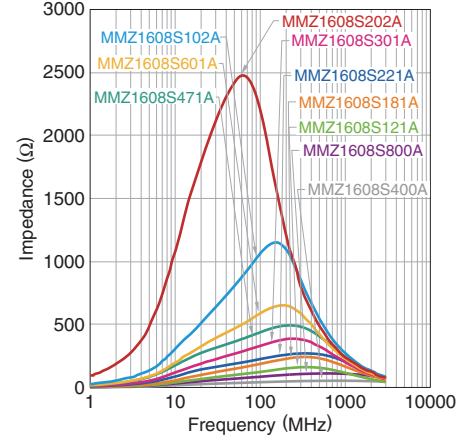

MMZ1608Y SERIES

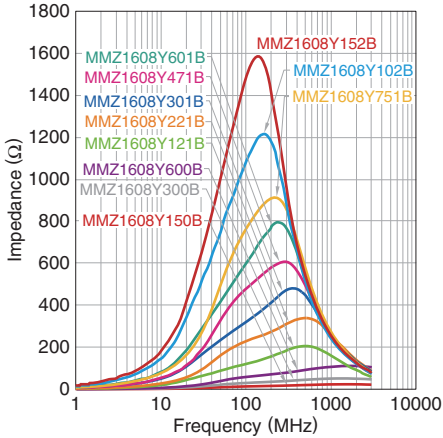

MMZ1608A SERIES

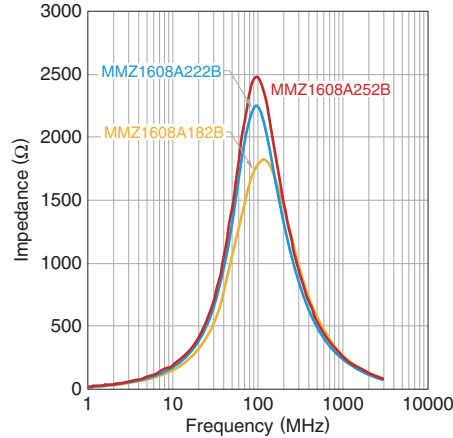

MMZ1608Q SERIES

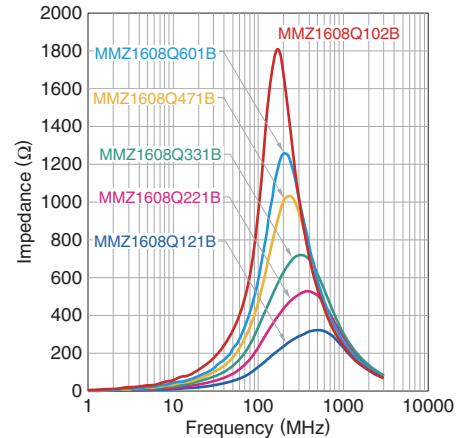

MMZ1608D SERIES

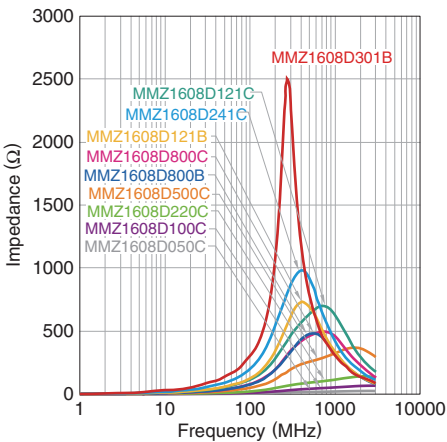

MMZ1608F SERIES

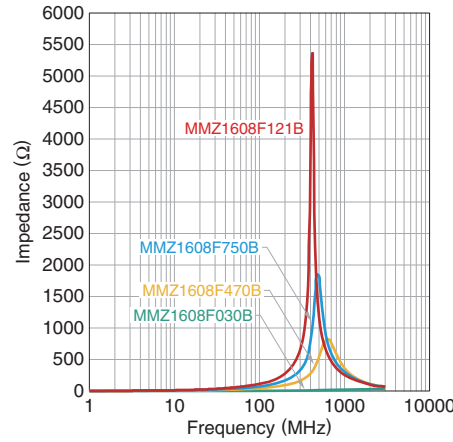

• All specifications are subject to change without notice.

# MMZ series MMZ1608 Type

## ELECTRICAL CHARACTERISTICS

### Z, X, R VS. FREQUENCY CHARACTERISTICS

MMZ1608B121CTDH5

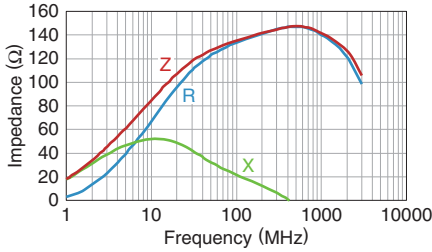

MMZ1608B221CTDH5

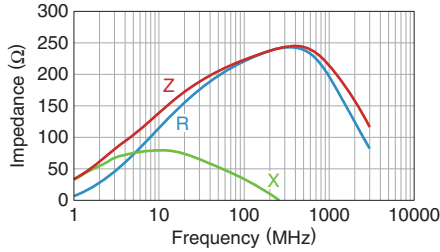

MMZ1608B301CTDH5

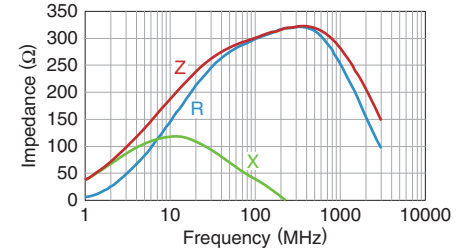

MMZ1608B471CTDH5

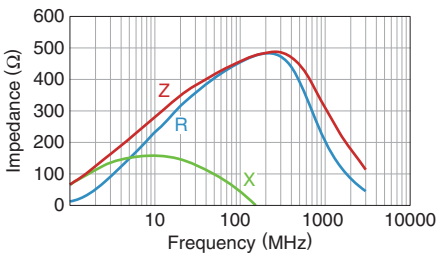

MMZ1608B601CTDH5

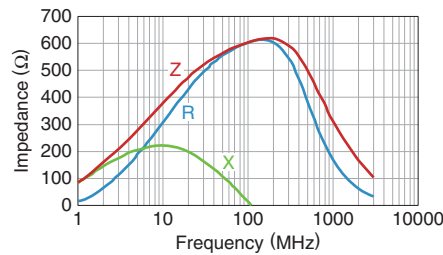

MMZ1608B102CTD25

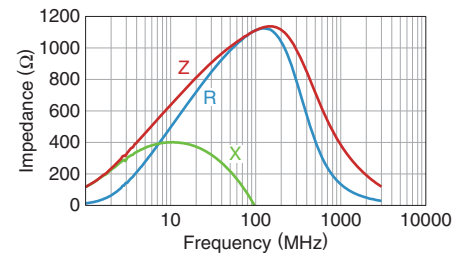

MMZ1608R150ATD25

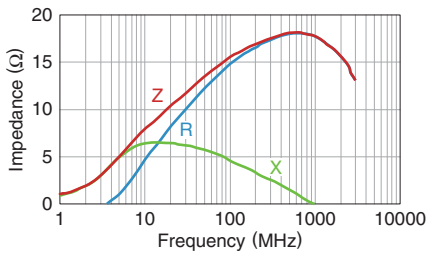

MMZ1608R300ATD25

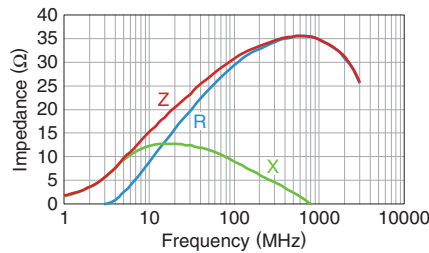

MMZ1608R600ATD25

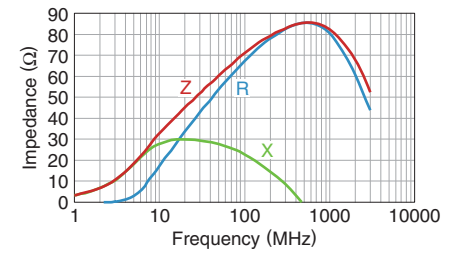

MMZ1608R121ATD25

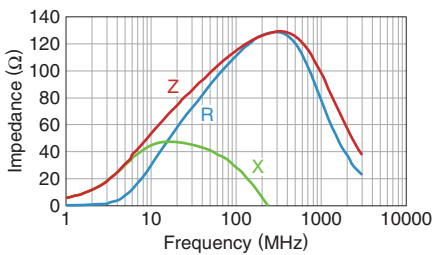

MMZ1608R301ATD25

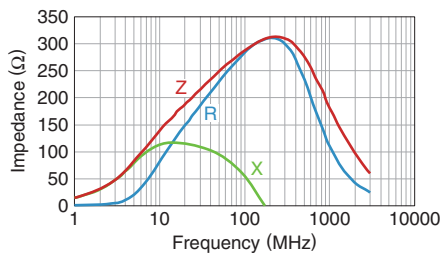

MMZ1608R471ATD25

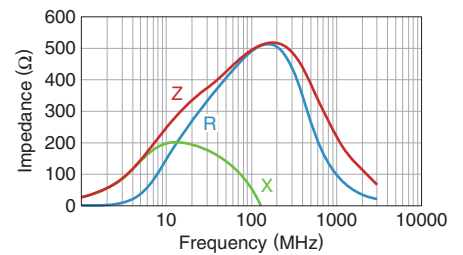

MMZ1608R601ATD25

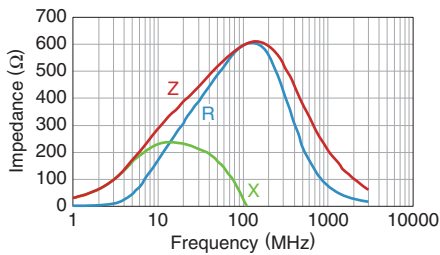

MMZ1608R102ATD25

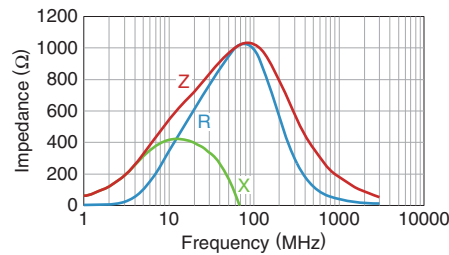

MMZ1608S400ATD25

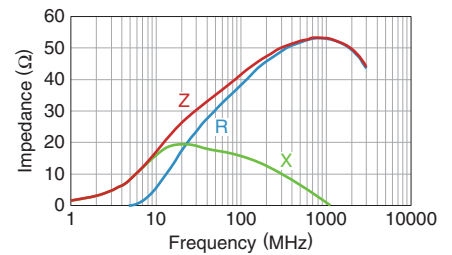

• All specifications are subject to change without notice.

# MMZ series MMZ1608 Type

## ELECTRICAL CHARACTERISTICS

### Z, X, R VS. FREQUENCY CHARACTERISTICS

MMZ1608S800ATD25

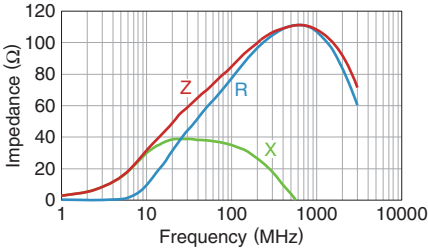

MMZ1608S121ATD25

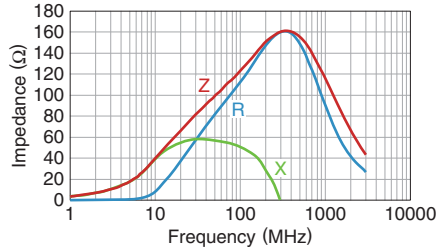

MMZ1608S181ATD25

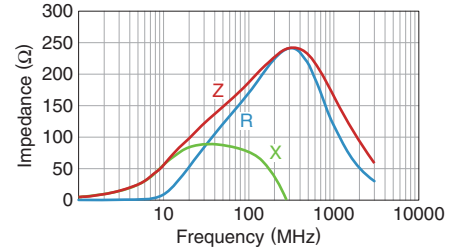

MMZ1608S221ATD25

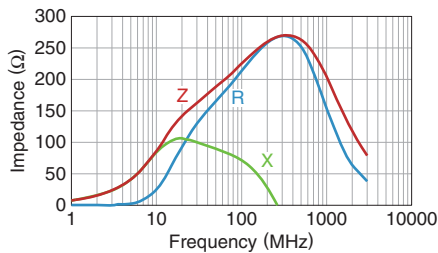

MMZ1608S301ATD25

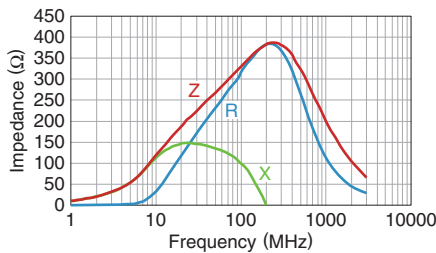

MMZ1608S471ATD25

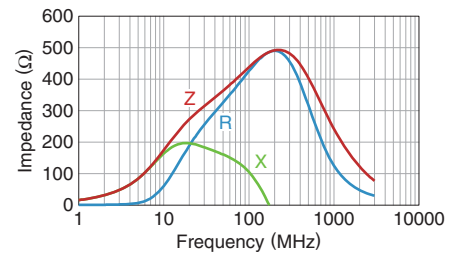

MMZ1608S601ATD25

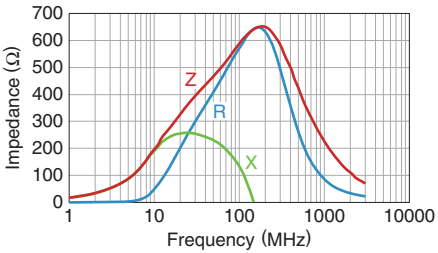

MMZ1608S102ATD25

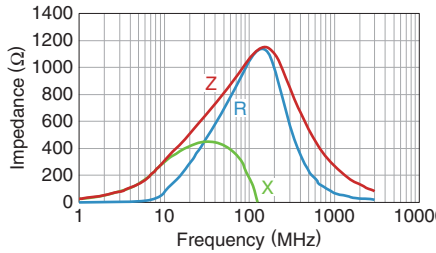

MMZ1608S202ATD25

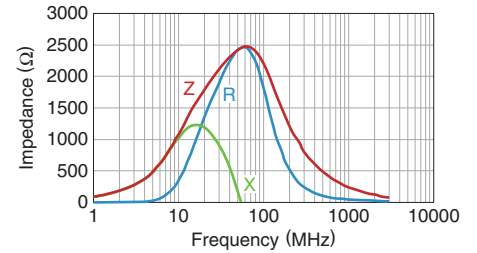

MMZ1608Y150BTD25

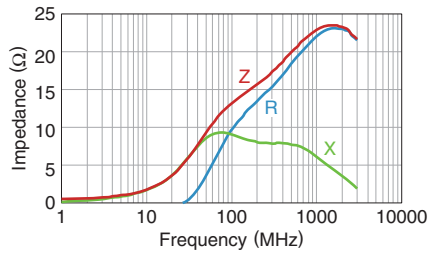

MMZ1608Y300BTD25

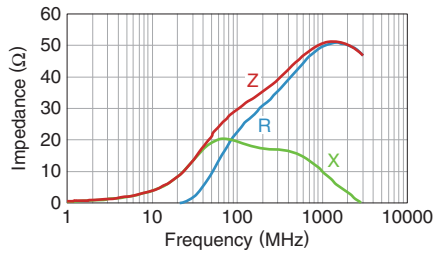

MMZ1608Y600BTD25

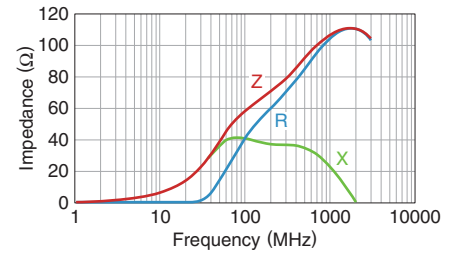

MMZ1608Y121BTD25

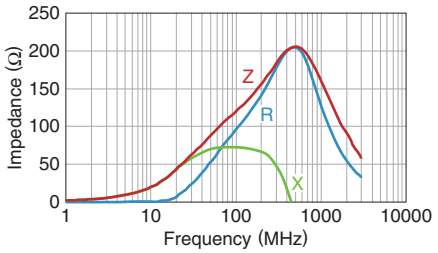

MMZ1608Y221BTD25

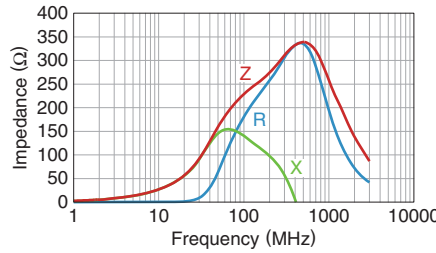

MMZ1608Y301BTD25

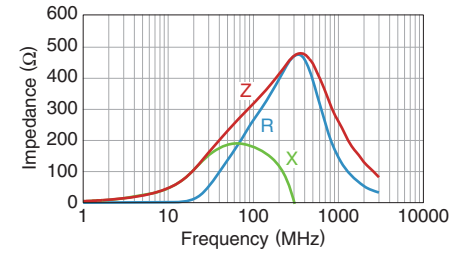

• All specifications are subject to change without notice.



# MMZ series MMZ1608 Type

## ELECTRICAL CHARACTERISTICS

### Z, X, R VS. FREQUENCY CHARACTERISTICS

MMZ1608Y471BTD25

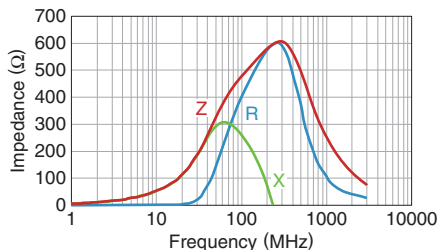

MMZ1608Y601BTD25

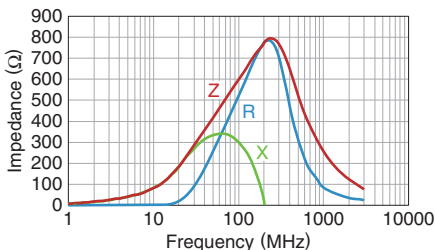

MMZ1608Y751BTD25

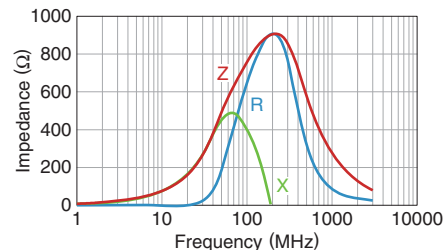

MMZ1608Y102BTD25

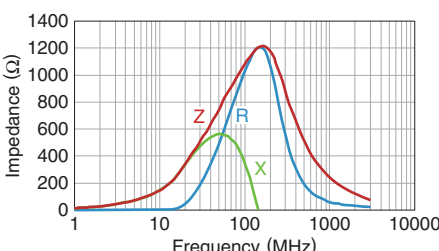

MMZ1608Y152BTD25

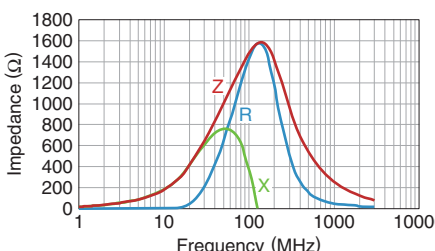

MMZ1608A182BTD25

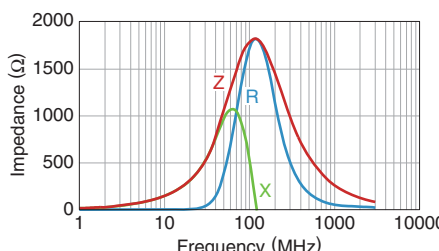

MMZ1608A222BTD25

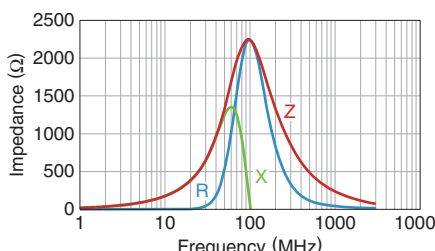

MMZ1608A252BTD25

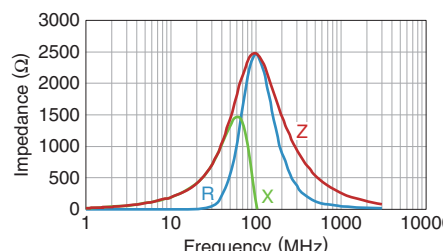

MMZ1608Q121BTD25

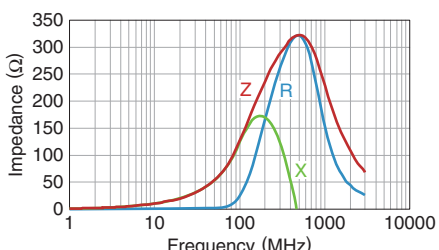

MMZ1608Q221BTD25

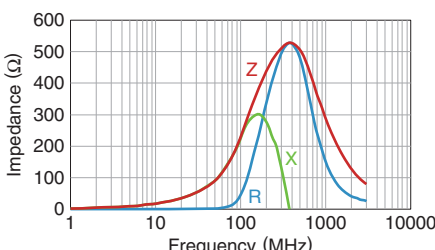

MMZ1608Q331BTD25

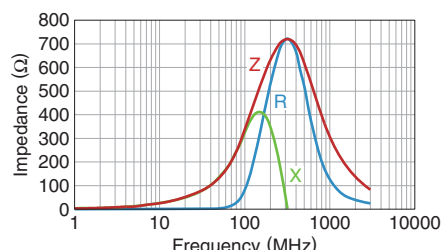

MMZ1608Q471BTD25

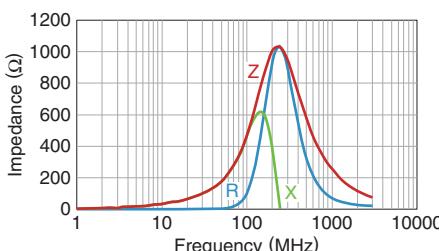

MMZ1608Q601BTD25

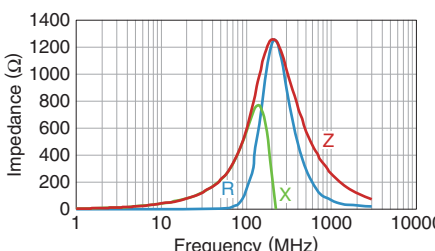

MMZ1608Q102BTD25

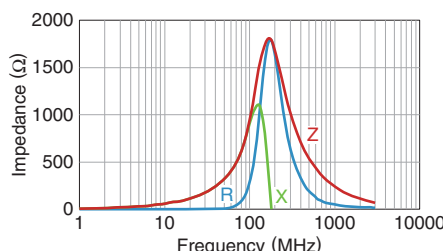

• All specifications are subject to change without notice.

# MMZ series MMZ1608 Type

## ELECTRICAL CHARACTERISTICS

### Z, X, R VS. FREQUENCY CHARACTERISTICS

MMZ1608D050CTD25

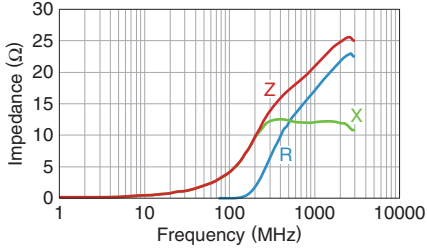

MMZ1608D100CTDH5

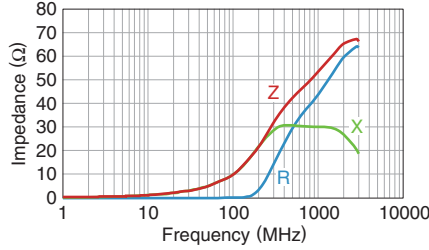

MMZ1608D220CTDH5

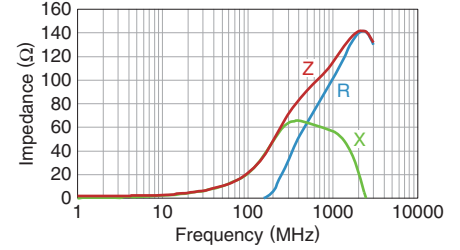

MMZ1608D500CTDH5

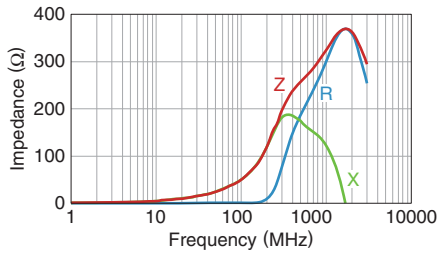

MMZ1608D800CTDH5

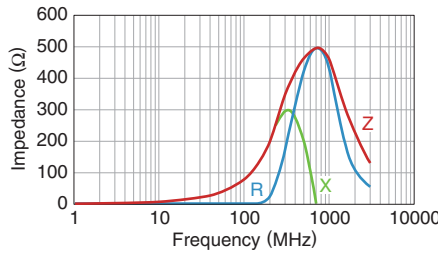

MMZ1608D800BTD25

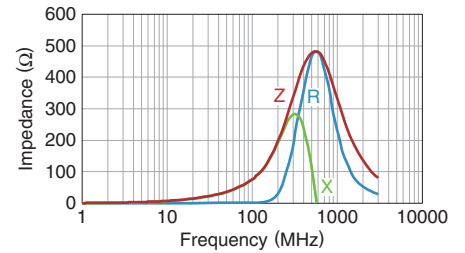

MMZ1608D121CTDH5

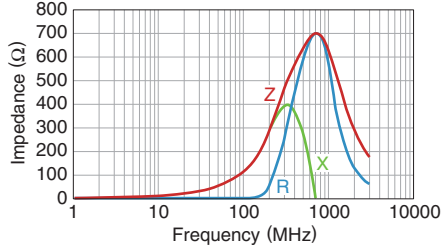

MMZ1608D121BTD25

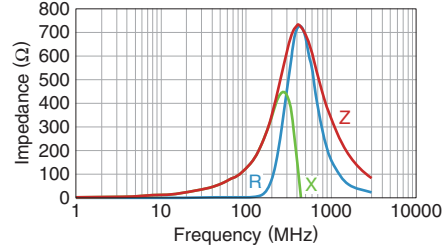

MMZ1608D241CTD25

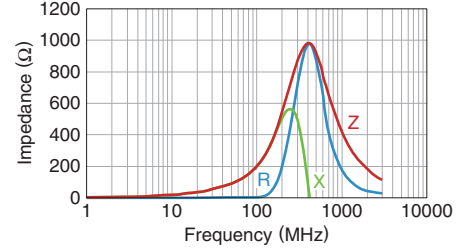

MMZ1608D301BTD25

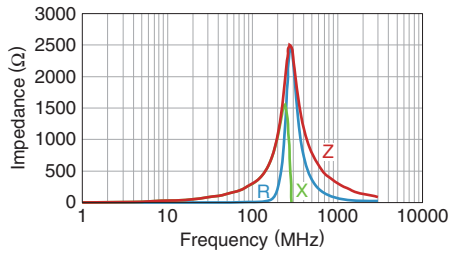

MMZ1608F030BTD25

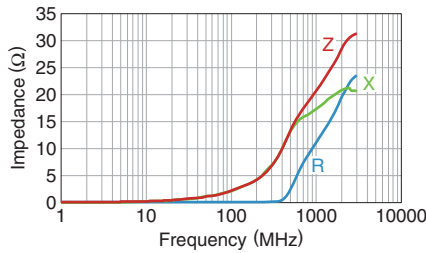

MMZ1608F470BTD25

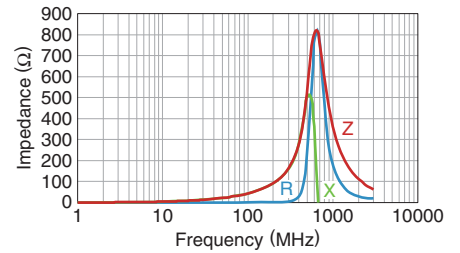

MMZ1608F750BTD25

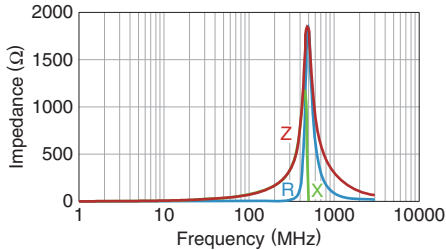

MMZ1608F121BTD25

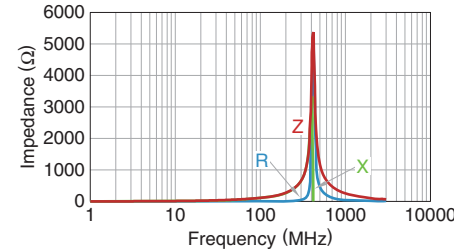

• All specifications are subject to change without notice.

MMZ series

# MMZ2012 Type



## SHAPE & DIMENSIONS

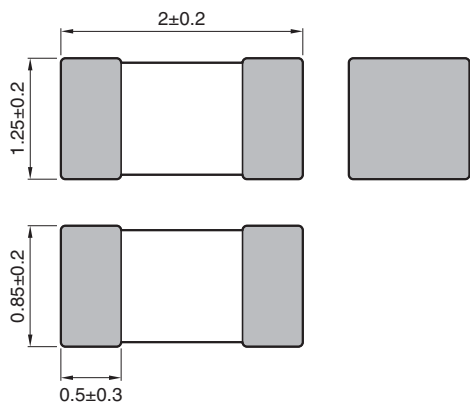

Dimensions in mm

## RECOMMENDED LAND PATTERN

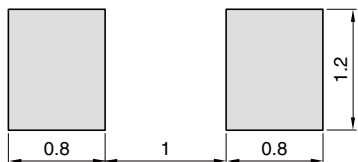

Dimensions in mm

• All specifications are subject to change without notice.

# MMZ series MMZ2012 Type

## ■ ELECTRICAL CHARACTERISTICS

### □ CHARACTERISTICS SPECIFICATION TABLE

Impedance [100MHz] ( $\Omega$ )	Tolerance	DC resistance ( $\Omega$ )max.	Rated current (mA)max.	Part No.
15	±25%	0.05	1500	MMZ2012R150ATD25
30	±25%	0.05	1500	MMZ2012R300ATD25
60	±25%	0.10	1000	MMZ2012R600ATD25
120	±25%	0.12	800	MMZ2012R121ATD25
300	±25%	0.15	600	MMZ2012R301ATD25
600	±25%	0.20	500	MMZ2012R601ATD25
1000	±25%	0.30	500	MMZ2012R102ATD25
40	±25%	0.10	1000	MMZ2012S400ATD25
80	±25%	0.10	800	MMZ2012S800ATD25
120	±25%	0.15	800	MMZ2012S121ATD25
180	±25%	0.15	600	MMZ2012S181ATD25
300	±25%	0.20	600	MMZ2012S301ATD25
600	±25%	0.30	500	MMZ2012S601ATD25
1000	±25%	0.35	500	MMZ2012S102ATD25
15	±25%	0.05	1500	MMZ2012Y150BTD25
30	±25%	0.05	1500	MMZ2012Y300BTD25
60	±25%	0.10	1000	MMZ2012Y600BTD25
120	±25%	0.12	800	MMZ2012Y121BTD25
300	±25%	0.15	600	MMZ2012Y301BTD25
600	±25%	0.20	500	MMZ2012Y601BTD25
1000	±25%	0.30	500	MMZ2012Y102BTD25
1500	±25%	0.40	500	MMZ2012Y152BTD25
2000	±25%	0.50	400	MMZ2012Y202BTD25
80	±25%	0.30	500	MMZ2012D800BTD25
120	±25%	0.30	500	MMZ2012D121BTD25
300	±25%	0.50	400	MMZ2012D301BTD25

### ○ Measurement equipment

Measurement item	Product No.	Manufacturer
Impedance	E4991A+16192A	Agilent Technologies
DC resistance	Type-7556	Yokogawa

\* Equivalent measurement equipment may be used.

# MMZ series MMZ2012 Type

## ELECTRICAL CHARACTERISTICS

### Z VS. FREQUENCY CHARACTERISTICS (BY SERIES)

MMZ2012R SERIES

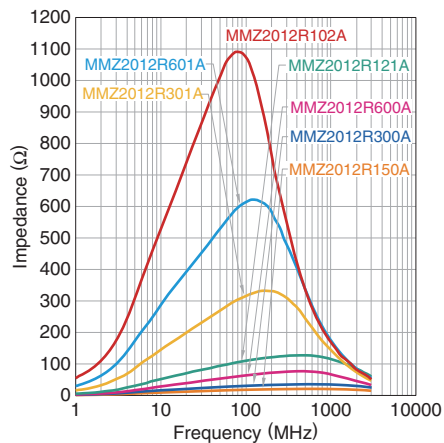

MMZ2012S SERIES

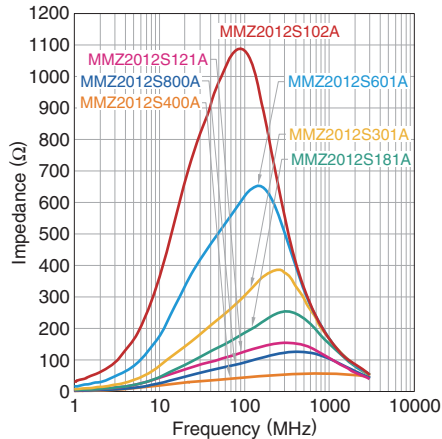

MMZ2012Y SERIES

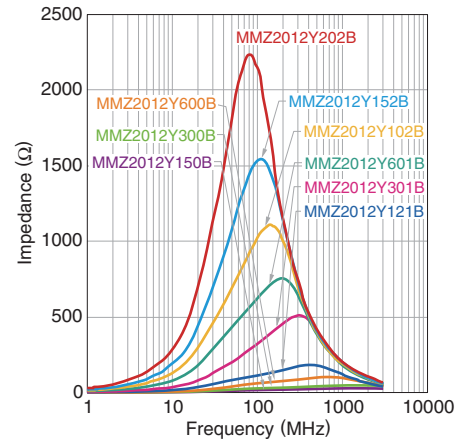

MMZ2012D SERIES

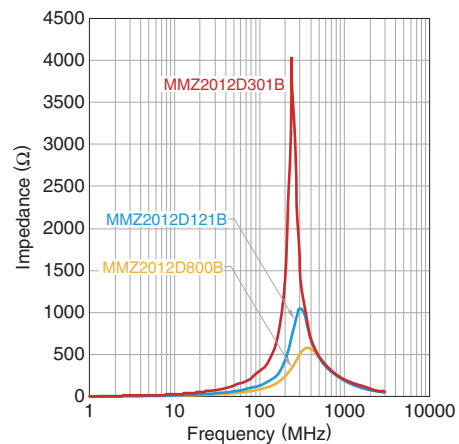

• All specifications are subject to change without notice.

# MMZ series MMZ2012 Type

## ELECTRICAL CHARACTERISTICS

### Z, X, R VS. FREQUENCY CHARACTERISTICS

MMZ2012R150ATD25

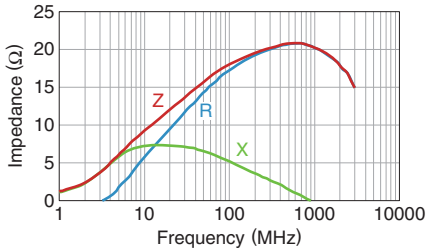

MMZ2012R300ATD25

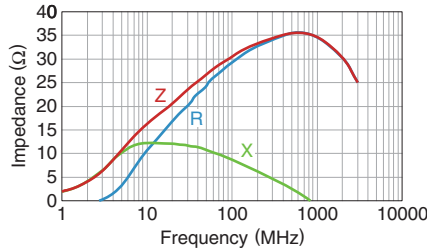

MMZ2012R600ATD25

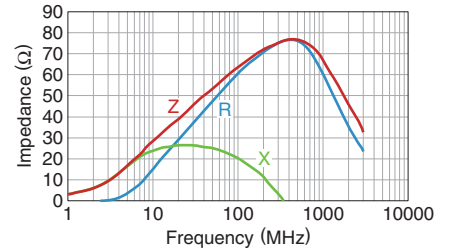

MMZ2012R121ATD25

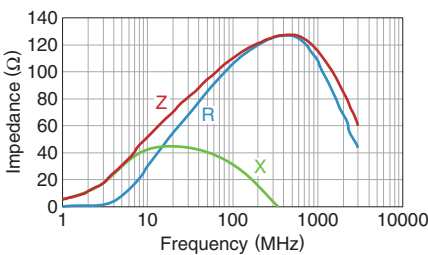

MMZ2012R301ATD25

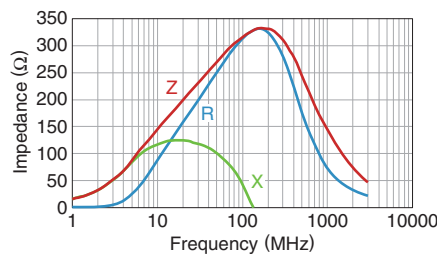

MMZ2012R601ATD25

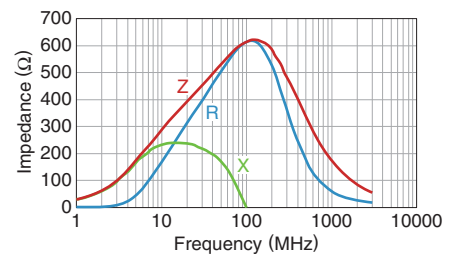

MMZ2012R102ATD25

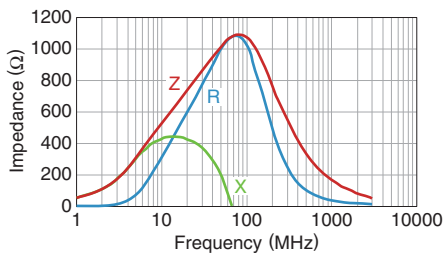

MMZ2012S400ATD25

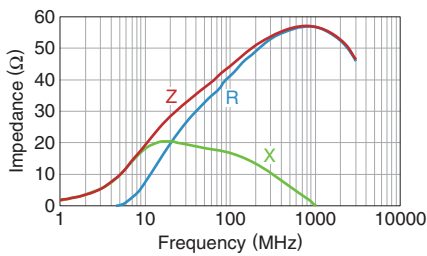

MMZ2012S800ATD25

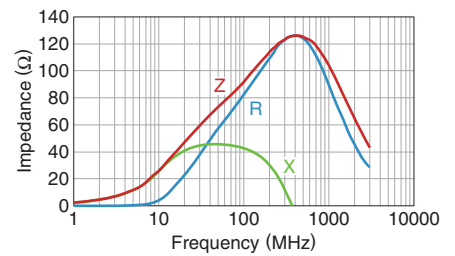

MMZ2012S121ATD25

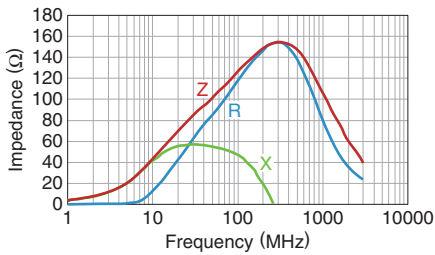

MMZ2012S181ATD25

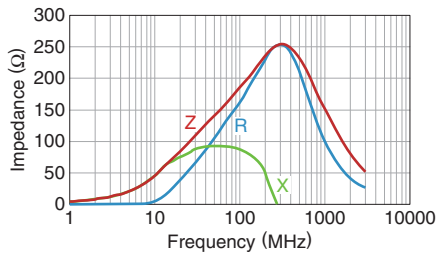

MMZ2012S301ATD25

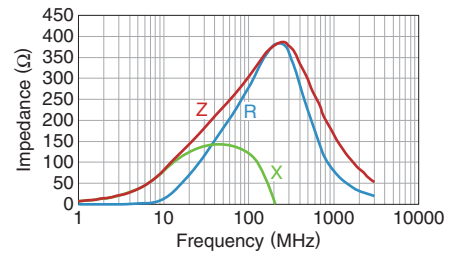

MMZ2012S601ATD25

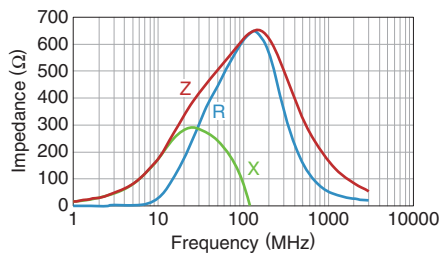

MMZ2012S102ATD25

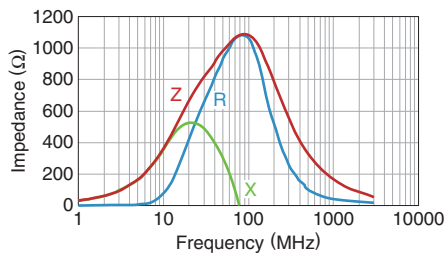

MMZ2012Y150BTD25

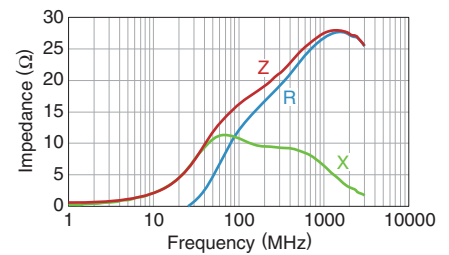

• All specifications are subject to change without notice.

# MMZ series MMZ2012 Type

## ELECTRICAL CHARACTERISTICS

### Z, X, R VS. FREQUENCY CHARACTERISTICS

MMZ2012Y300BTD25

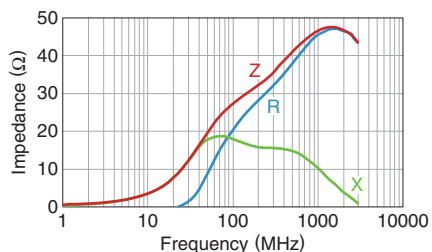

MMZ2012Y600BTD25

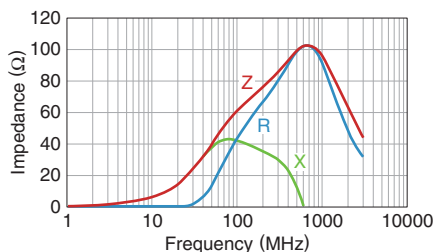

MMZ2012Y121BTD25

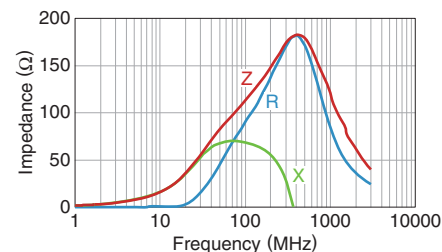

MMZ2012Y301BTD25

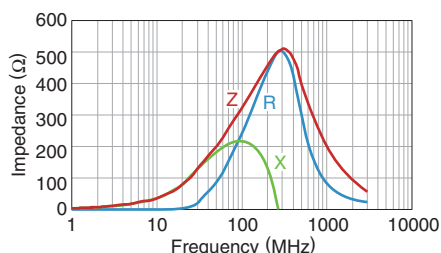

MMZ2012Y601BTD25

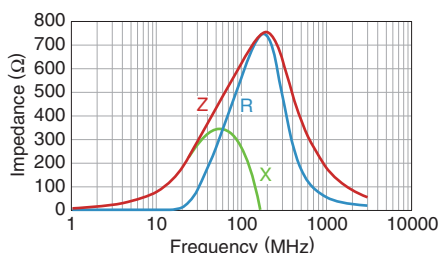

MMZ2012Y102BTD25

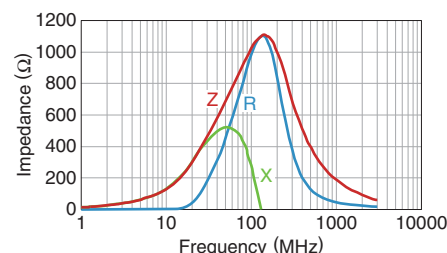

MMZ2012Y152BTD25

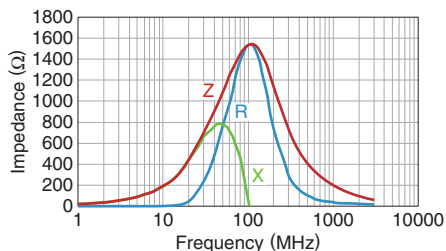

MMZ2012Y202BTD25

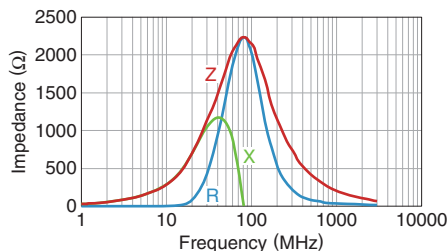

MMZ2012D800BTD25

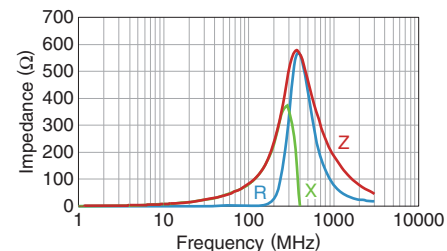

MMZ2012D121BTD25

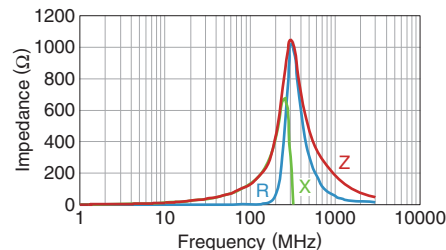

MMZ2012D301BTD25

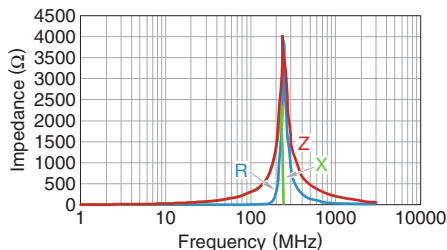

• All specifications are subject to change without notice.

# MMZ series

# Packaging style

## REEL DIMENSIONS

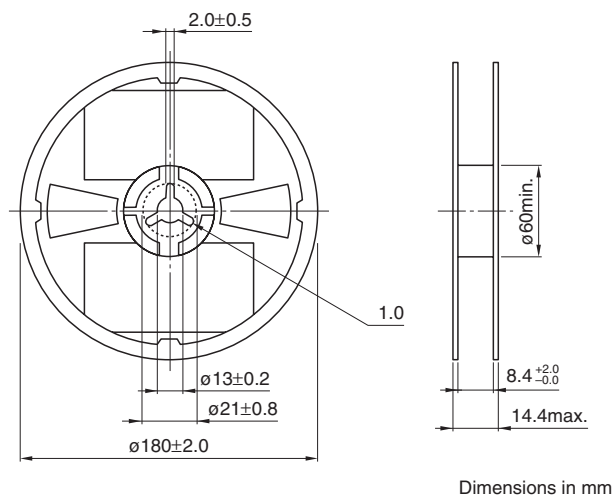

Dimensions in mm

## TAPE DIMENSIONS

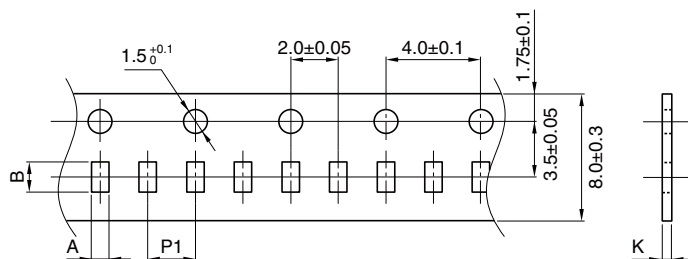

Dimensions in mm

Type	A	B	P1	K
MMZ1005	0.65±0.1	1.15±0.1	2.0±0.05	0.8max.
MMZ1608	1.1±0.2	1.9±0.2	4.0±0.1	1.1max.
MMZ2012	1.5±0.2	2.3±0.2	4.0±0.1	1.1max.

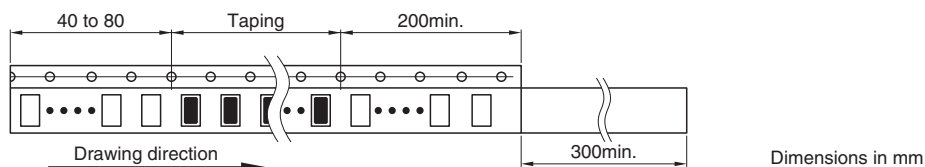

Dimensions in mm

• All specifications are subject to change without notice.