



Chip beads

For power line

MPZ series

MPZ1005_{Type}

MPZ1005

1005[0402 inch]*

* Dimensions code JIS[EIA]

Reminders for using these products

Before using these products, be sure to request the delivery specifications.

Safety reminders

Please pay sufficient attention to the warnings for safe designing when using this products.

Reminders

- The storage period is less than 12 months. Be sure to follow the storage conditions (temperature: 5 to 40°C, humidity: 10 to 75% RH or less).
If the storage period elapses, the soldering of the terminal electrodes may deteriorate.
- Do not use or store in locations where there are conditions such as gas corrosion (salt, acid, alkali, etc.).
- Before soldering, be sure to preheat components.
The preheating temperature should be set so that the temperature difference between the solder temperature and chip temperature does not exceed 150°C.
- Soldering corrections after mounting should be within the range of the conditions determined in the specifications.
If overheated, a short circuit, performance deterioration, or lifespan shortening may occur.
- When embedding a printed circuit board where a chip is mounted to a set, be sure that residual stress is not given to the chip due to the overall distortion of the printed circuit board and partial distortion such as at screw tightening portions.
- Self heating (temperature increase) occurs when the power is turned ON, so the tolerance should be sufficient for the set thermal design.
- Carefully lay out the coil for the circuit board design of the non-magnetic shield type.
A malfunction may occur due to magnetic interference.
- Use a wrist band to discharge static electricity in your body through the grounding wire.
- Do not expose the products to magnets or magnetic fields.
- Do not use for a purpose outside of the contents regulated in the delivery specifications.
- The products listed on this catalog are intended for use in general electronic equipment (AV equipment, telecommunications equipment, home appliances, amusement equipment, computer equipment, personal equipment, office equipment, measurement equipment, industrial robots) under a normal operation and use condition.
The products are not designed or warranted to meet the requirements of the applications listed below, whose performance and/or quality require a more stringent level of safety or reliability, or whose failure, malfunction or trouble could cause serious damage to society, person or property.
If you intend to use the products in the applications listed below or if you have special requirements exceeding the range or conditions set forth in the each catalog, please contact us.

- (1) Aerospace/aviation equipment
- (2) Transportation equipment (cars, electric trains, ships, etc.)
- (3) Medical equipment
- (4) Power-generation control equipment
- (5) Atomic energy-related equipment
- (6) Seabed equipment
- (7) Transportation control equipment

- (8) Public information-processing equipment
- (9) Military equipment
- (10) Electric heating apparatus, burning equipment
- (11) Disaster prevention/crime prevention equipment
- (12) Safety equipment
- (13) Other applications that are not considered general-purpose applications

When designing your equipment even for general-purpose applications, you are kindly requested to take into consideration securing protection circuit/device or providing backup circuits in your equipment.

Chip beads

For power line

Product compatible with RoHS directive
Halogen-free
Compatible with lead-free solders

Overview of MPZ1005 type

FEATURES

- Noise reduction solution for power line.
- Compared to the MMZ series, has low direct current resistance for compatibility with large currents, optimal for low power consumption.
- Various frequency characteristics with 2 materials of different features for countermeasures against everything from general signals to high-speed signals.
- Performs well even in signal lines where low direct current resistance is required.

APPLICATION

- Noise removal for mobile devices such as smartphones and tablet terminals, and various modules.
- Noise removal for PCs and recorders, household appliances such as STBs, smart grids, and industrial equipment.

PART NUMBER CONSTRUCTION

MPZ	1005		S	100		C	T		000
Series name	LxWxT dimensions (mm)		Material name	Impedance (Ω) at 100MHz		Characteristic type	Packaging style		Internal code
	1005	1.0x0.5x0.5	S	100	10	C	T	Taping	000
			Y	121	120				

OPERATING TEMPERATURE RANGE, PACKAGE QUANTITY, PRODUCT WEIGHT

Type	Temperature ranges		Package quantity (pieces/reel)	Individual weight (mg)
	Operating temperature (°C)	Storage temperature* (°C)		
MPZ1005	-55 to +125	-55 to +125	10,000	1

* The storage temperature range is for after the circuit board is mounted.

- RoHS Directive Compliant Product: See the following for more details.<https://product.tdk.com/info/en/environment/rohs/index.html>
- Halogen-free: indicates that Cl content is less than 900ppm, Br content is less than 900ppm, and that the total Cl and Br content is less than 1500ppm.

 Please be sure to request delivery specifications that provide further details on the features and specifications of the products for proper and safe use.
Please note that the contents may change without any prior notice due to reasons such as upgrading.

MPZ1005 type

RECOMMENDED REFLOW PROFILE

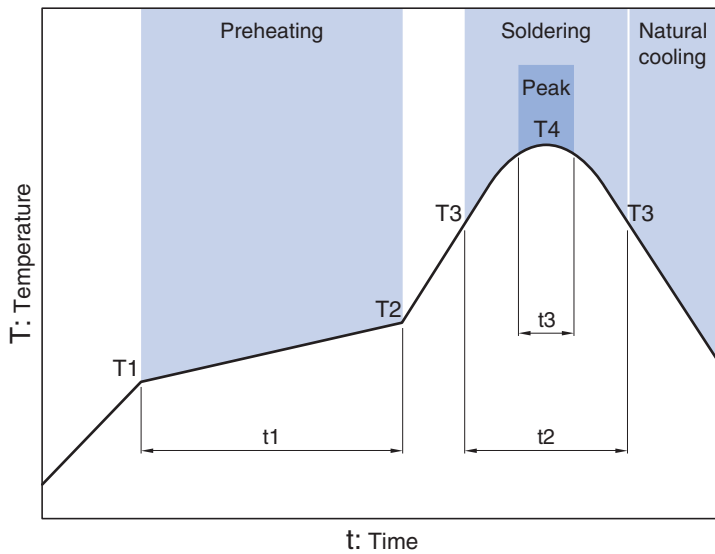

Preheating			Soldering		Peak	
Temp.	Temp.	Time	Temp.	Time	Temp.	Time
T1	T2	t1	T3	t2	T4	t3
150°C	180°C	60 to 120s	230°C	30 to 60s	250 to 260°C	10s

MPZ1005 type

MATERIAL CHARACTERISTIC

S material: Standard type that features impedance characteristics similar to those of a typical ferrite core. For signal line applications in which the blocking region is near 100MHz. Impedance values selected for effectiveness at 40 to 300MHz.

Y material: High frequency range type intended for the 100MHz region and above. For signal line applications in which the signal frequency is far from the cutoff frequency. Impedance values selected for effectiveness at 80 to 400MHz.

TYPICAL MATERIAL IMPEDANCE CHARACTERISTICS

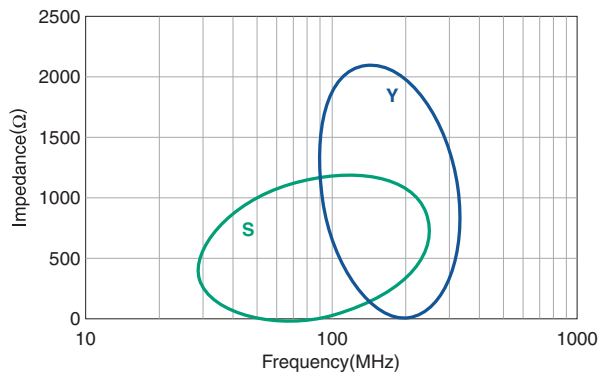

MPZ1005 type

SHAPE & DIMENSIONS

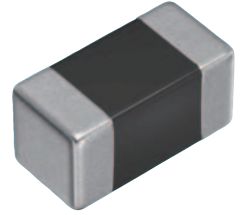
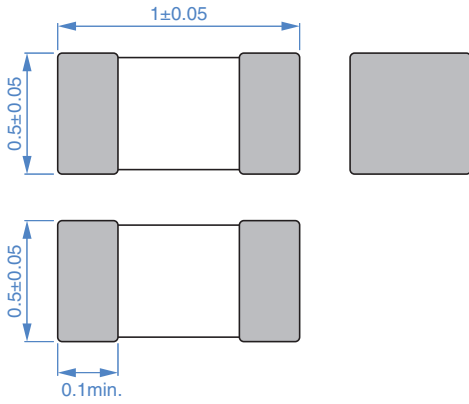

Dimensions in mm

RECOMMENDED LAND PATTERN

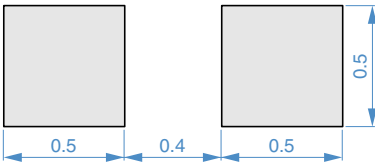

Dimensions in mm

Please be sure to request delivery specifications that provide further details on the features and specifications of the products for proper and safe use. Please note that the contents may change without any prior notice due to reasons such as upgrading.

MPZ1005 type

ELECTRICAL CHARACTERISTICS

CHARACTERISTICS SPECIFICATION TABLE

Impedance [100MHz]		DC resistance	Rated current*	Part No.
(Ω)	Tolerance	(Ω)max.	(A)max.	
10	$\pm 5\Omega$	0.025	3.0	MPZ1005S100CT000
30	$\pm 10\Omega$	0.035	1.7	MPZ1005S300CT000
60	$\pm 25\%$	0.060	1.5	MPZ1005S600CT000
120	$\pm 25\%$	0.090	1.2	MPZ1005S121CT000
90	$\pm 25\%$	0.100	1.2	MPZ1005Y900CT000

* Please refer to the graph of rated current vs. temperature characteristics (derating) about the rating current at 85°C or more in temperature of the product.

Measurement equipment

Measurement item	Product No.	Manufacturer
Impedance	E4991A+16192A	Keysight Technologies
DC resistance	Type-7556	Yokogawa

* Equivalent measurement equipment may be used.

Rated current vs. temperature characteristics (derating)

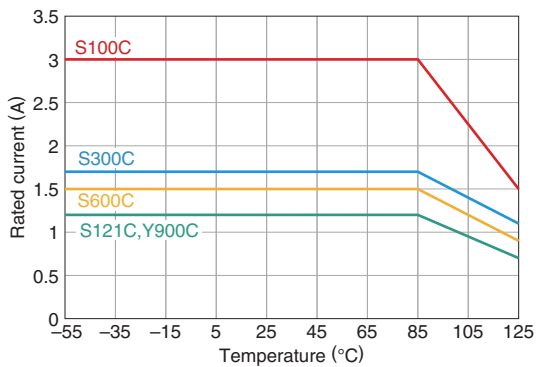

MPZ1005 type

ELECTRICAL CHARACTERISTICS

Z VS. FREQUENCY CHARACTERISTICS (BY SERIES)

MPZ1005S series

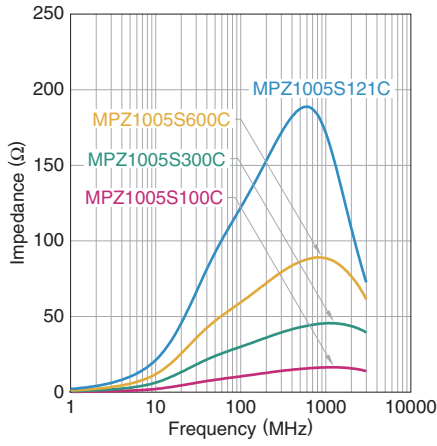

MPZ1005Y series

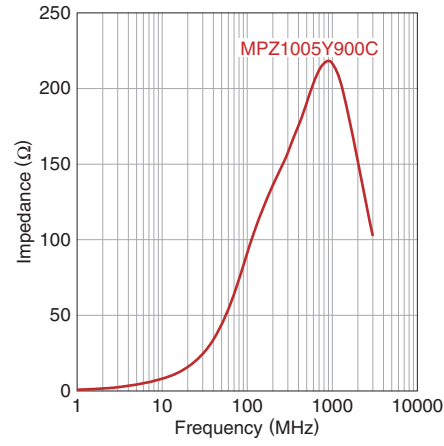

⚠ Please be sure to request delivery specifications that provide further details on the features and specifications of the products for proper and safe use. Please note that the contents may change without any prior notice due to reasons such as upgrading.

MPZ1005 type

ELECTRICAL CHARACTERISTICS

Z, X, R VS. FREQUENCY CHARACTERISTICS

MPZ1005S100CT000

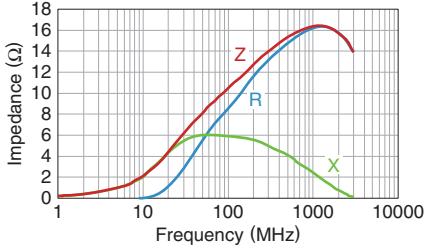

MPZ1005S300CT000

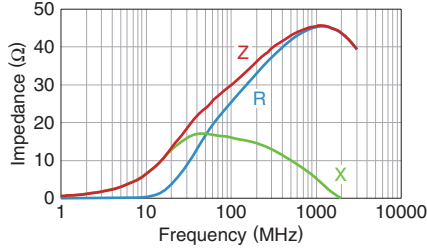

MPZ1005S600CT000

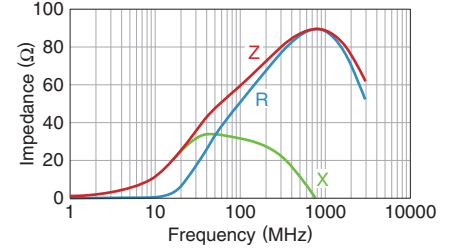

MPZ1005S121CT000

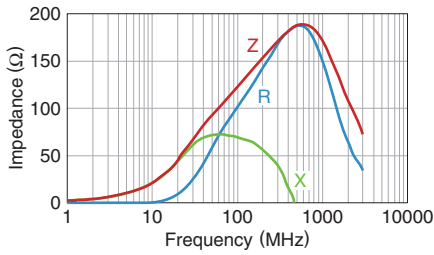

MPZ1005Y900CT000

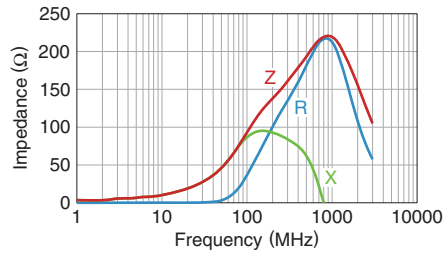

 Please be sure to request delivery specifications that provide further details on the features and specifications of the products for proper and safe use. Please note that the contents may change without any prior notice due to reasons such as upgrading.

MPZ1005 type

PACKAGING STYLE

REEL DIMENSIONS

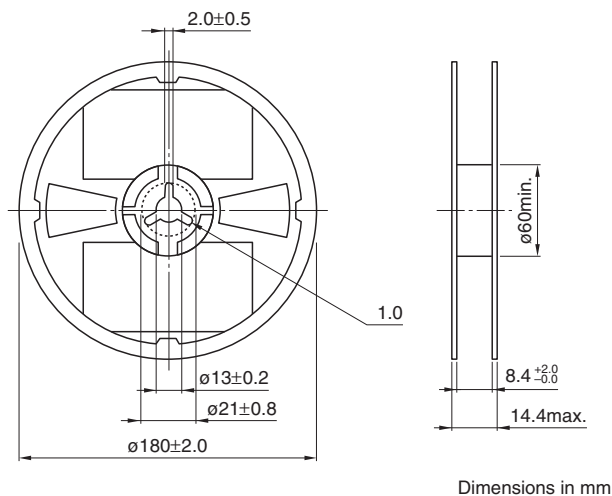

TAPE DIMENSIONS

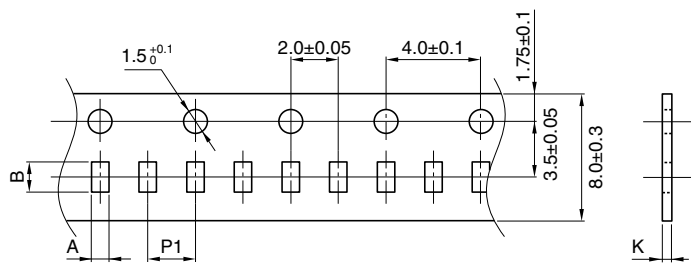

Type	A	B	P1	K
MPZ1005	0.65±0.1	1.15±0.1	2.0±0.05	0.8max.

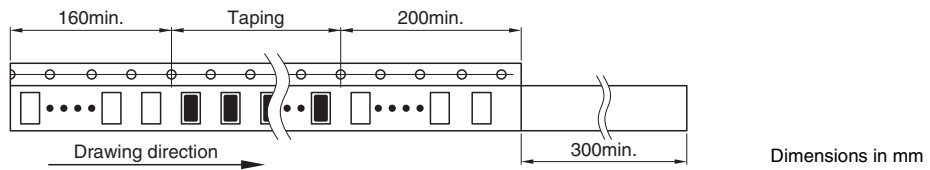

⚠ Please be sure to request delivery specifications that provide further details on the features and specifications of the products for proper and safe use. Please note that the contents may change without any prior notice due to reasons such as upgrading.