

SPECIFICATION

SPEC. No. C-General-e

D A T E : 2017 Aug.

To

Non-Controlled Copy

CUSTOMER'S PRODUCT NAME

TDK PRODUCT NAME

MULTILAYER CERAMIC CHIP CAPACITORS

C Series / Commercial grade

General (Up to 50V)

Mid voltage (100 to 630V)

Please return this specification to TDK representatives.

If orders are placed without returned specification, please allow us to judge that specification is accepted by your side.

RECEIPT CONFIRMATION

DATE: YEAR MONTH DAY

TDK Corporation

Sales

Electronic Components

Sales & Marketing Group

Engineering

Electronic Components Business Company

Ceramic Capacitors Business Group

APPROVED	Person in charge

APPROVED	CHECKED	Person in charge

1. SCOPE

This specification is applicable to chip type multilayer ceramic capacitors with a priority over the other relevant specifications.

Production places defined in this specification shall be TDK Corporation Japan, TDK (Suzhou) Co., Ltd and TDK Components U.S.A. Inc.

EXPLANATORY NOTE:

This specification warrants the quality of the ceramic chip capacitors. The chips should be evaluated or confirmed a state of mounted on your product.

If the use of the chips goes beyond the bounds of the specification, we can not afford to guarantee.

2. CODE CONSTRUCTION

(Example)

Catalog Number :	<u>C2012</u>	<u>X7R</u>	<u>1E</u>	<u>105</u>	<u>K</u>	<u>125</u>	<u>A</u>	<u>A</u>
(Web)	(1)	(2)	(3)	(4)	(5)	(6)	(7)	(8)
Item Description :	<u>C2012</u>	<u>X7R</u>	<u>1E</u>	<u>105</u>	<u>K</u>	<u>T</u>	<u>xxxx</u>	
	(1)	(2)	(3)	(4)	(5)	(9)	(10)	

(1) Type



*As for dimensions of each product, please refer to detailed information on TDK web.

(2) Temperature Characteristics (Details are shown in table 1 No.7 and No.8 at page 5)

(3) Rated Voltage

Symbol	Rated Voltage
2 J	DC 630 V
2 W	DC 450 V
2 V	DC 350 V
2 E	DC 250 V
2 A	DC 100 V
1 H	DC 50 V
1 V	DC 35 V
1 E	DC 25 V
1 C	DC 16 V
1 A	DC 10 V
0 J	DC 6.3 V
0 G	DC 4 V

(4) Rated Capacitance

Stated in three digits and in units of pico farads (pF).

The first and Second digits identify the first and second significant figures of the capacitance, the third digit identifies the multiplier.

R is designated for a decimal point.

Example 2R2 → 2.2pF

105 → 1,000,000pF

(5) Capacitance tolerance

Symbol	Tolerance	Capacitance
B	± 0.1 pF	10pF and under
C	± 0.25 pF	
D	± 0.5 pF	
J	± 5 %	Over 10pF
K	± 10 %	
M	± 20 %	

(6) Thickness code (Only Catalog Number)

(7) Package code (Only Catalog Number)

(8) Special code (Only Catalog Number)

(9) Packaging (Only Item Description)

Symbol	Packaging
B	Bulk
T	Taping

(10) Internal code (Only Item Description)

3. RATED CAPACITANCE AND CAPACITANCE TOLERANCE

3.1 Standard combination of rated capacitance and tolerances

Class	Temperature Characteristics	Capacitance tolerance		Rated capacitance
1	C H C0G	10pF and under	C ($\pm 0.25\text{pF}$)	0.5, 1, 1.5, 2, 2.2, 3, 3.3, 4, 4.7, 5
			D ($\pm 0.5\text{pF}$)	6, 6.8, 7, 8, 9, 10
		12pF to 10,000pF	J ($\pm 5\%$)	E – 12 series
		Over 10,000pF		E – 6 series
2	J B X5R X6S X7R X7S X7T	10uF and under	K ($\pm 10\%$) M ($\pm 20\%$)	E – 6 series
		Over 10uF	M ($\pm 20\%$)	

3.2 Capacitance Step in E series

E series	Capacitance Step											
E-3	1.0				2.2				4.7			
E-6	1.0	1.5	2.2	3.3	4.7	6.8						
E-12	1.0	1.2	1.5	1.8	2.2	2.7	3.3	3.9	4.7	5.6	6.8	8.2

4. OPERATING TEMPERATURE RANGE

T.C.	Min. operating Temperature	Max. operating Temperature	Reference Temperature
C H J B	-25°C	85°C	20°C
X5R	-55°C	85°C	25°C
X6S	-55°C	105°C	25°C
X7R X7S X7T C0G	-55°C	125°C	25°C

5. STORING CONDITION AND TERM

5 to 40°C at 20 to 70%RH

6 months Max.

6. P.C. BOARD

When mounting on an aluminum substrate, large case sizes such as C3225, C4532 and C5750 types are more likely to be affected by heat stress from the substrate.

Please inquire separate specification for the large case sizes when mounted on the substrate.

7. INDUSTRIAL WASTE DISPOSAL

Dispose this product as industrial waste in accordance with the Industrial Waste Law.

8. PERFORMANCE

table 1

No.	Item	Performance	Test or inspection method																	
1	External Appearance	No defects which may affect performance.	Inspect with magnifying glass (3×), in case of C0402 and C0603 type, with magnifying glass (10×)																	
2	Insulation Resistance	10,000MΩ or 500MΩ·μF min. (As for the capacitors of rated voltage 16, 10V DC and lower, 10,000 MΩ or 100MΩ·μF min.,) whichever smaller.	Apply rated voltage for 60s.																	
3	Voltage Proof	Withstand test voltage without insulation breakdown or other damage.	<table border="1"> <thead> <tr> <th>Class</th> <th>Rated voltage</th> <th>Apply voltage</th> </tr> </thead> <tbody> <tr> <td rowspan="3">1</td> <td>$RV \leq 100V$</td> <td>3 × rated voltage</td> </tr> <tr> <td>$100V < RV \leq 500V$</td> <td>1.5 × rated voltage</td> </tr> <tr> <td>$500V < RV$</td> <td>1.3 × rated voltage</td> </tr> <tr> <td rowspan="3">2</td> <td>$RV \leq 100V$</td> <td>2.5 × rated voltage</td> </tr> <tr> <td>$100V < RV \leq 500V$</td> <td>1.5 × rated voltage</td> </tr> <tr> <td>$500V < RV$</td> <td>1.3 × rated voltage</td> </tr> </tbody> </table> <p>Above DC voltage shall be applied for 1s. Charge / discharge current shall not exceed 50mA.</p>	Class	Rated voltage	Apply voltage	1	$RV \leq 100V$	3 × rated voltage	$100V < RV \leq 500V$	1.5 × rated voltage	$500V < RV$	1.3 × rated voltage	2	$RV \leq 100V$	2.5 × rated voltage	$100V < RV \leq 500V$	1.5 × rated voltage	$500V < RV$	1.3 × rated voltage
Class	Rated voltage	Apply voltage																		
1	$RV \leq 100V$	3 × rated voltage																		
	$100V < RV \leq 500V$	1.5 × rated voltage																		
	$500V < RV$	1.3 × rated voltage																		
2	$RV \leq 100V$	2.5 × rated voltage																		
	$100V < RV \leq 500V$	1.5 × rated voltage																		
	$500V < RV$	1.3 × rated voltage																		
4	Capacitance	Within the specified tolerance.	<table border="1"> <thead> <tr> <th>Class</th> <th>Rated Capacitance</th> <th>Measuring frequency</th> <th>Measuring voltage</th> </tr> </thead> <tbody> <tr> <td rowspan="2">1</td> <td>1000pF and under</td> <td>1MHz±10%</td> <td rowspan="2">0.5-5Vrms.</td> </tr> <tr> <td>Over 1000pF</td> <td>1kHz±10%</td> </tr> <tr> <td rowspan="2">2</td> <td>10uF and under</td> <td>1kHz±10%</td> <td>0.5±0.2Vrms.</td> </tr> <tr> <td>Over 10uF</td> <td>120Hz±20%</td> <td>1.0±0.2Vrms.</td> </tr> </tbody> </table>	Class	Rated Capacitance	Measuring frequency	Measuring voltage	1	1000pF and under	1MHz±10%	0.5-5Vrms.	Over 1000pF	1kHz±10%	2	10uF and under	1kHz±10%	0.5±0.2Vrms.	Over 10uF	120Hz±20%	1.0±0.2Vrms.
Class	Rated Capacitance	Measuring frequency	Measuring voltage																	
1	1000pF and under	1MHz±10%	0.5-5Vrms.																	
	Over 1000pF	1kHz±10%																		
2	10uF and under	1kHz±10%	0.5±0.2Vrms.																	
	Over 10uF	120Hz±20%	1.0±0.2Vrms.																	
5	Q (Class1)	<table border="1"> <thead> <tr> <th>Rated Capacitance</th> <th>Q</th> </tr> </thead> <tbody> <tr> <td>30pF and over</td> <td>1,000 min.</td> </tr> <tr> <td>Under 30pF</td> <td>400+20×C min.</td> </tr> </tbody> </table> <p>C : Rated capacitance (pF)</p>	Rated Capacitance	Q	30pF and over	1,000 min.	Under 30pF	400+20×C min.	See No.4 in this table for measuring condition.											
Rated Capacitance	Q																			
30pF and over	1,000 min.																			
Under 30pF	400+20×C min.																			
6	Dissipation Factor (Class2)	0.025 max. 0.03 max. 0.05 max. 0.075 max. 0.1 max.	See No.4 in this table for measuring condition. For information which product has which Dissipation Factor, please see the detail page of each product on website.																	

(continued)

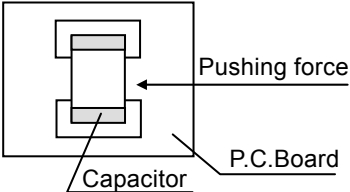
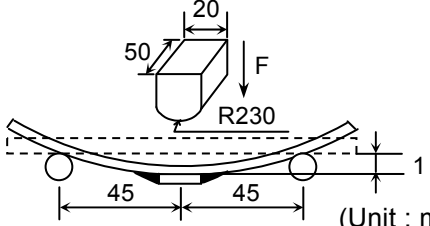
No.	Item	Performance	Test or inspection method																										
7	Temperature Characteristics of Capacitance (Class1)	<table border="1" data-bbox="520 237 901 383"> <thead> <tr> <th>T.C.</th> <th>Temperature Coefficient (ppm/°C)</th> </tr> </thead> <tbody> <tr> <td>CH</td> <td>0 ± 60</td> </tr> <tr> <td>C0G</td> <td>0 ± 30</td> </tr> </tbody> </table> <p>Capacitance drift Within ± 0.2% or ±0.05pF, whichever larger.</p>	T.C.	Temperature Coefficient (ppm/°C)	CH	0 ± 60	C0G	0 ± 30	<p>Temperature coefficient shall be calculated based on values at 25°C (CH : 20°C) and 85°C temperature.</p> <p>Measuring temperature below 20°C shall be -10°C and -25°C.</p>																				
T.C.	Temperature Coefficient (ppm/°C)																												
CH	0 ± 60																												
C0G	0 ± 30																												
8	Temperature Characteristics of Capacitance (Class2)	<table border="1" data-bbox="520 533 901 1010"> <thead> <tr> <th colspan="2">Capacitance Change (%)</th> </tr> <tr> <th>No voltage applied</th> <th>With voltage applied</th> </tr> </thead> <tbody> <tr> <td>J B: ±10</td> <td>J B: +10,-30 +10,-50 +10,-60</td> </tr> <tr> <td>X5R: ±15</td> <td></td> </tr> <tr> <td>X6S: ±22</td> <td></td> </tr> <tr> <td>X7R: ±15</td> <td>---</td> </tr> <tr> <td>X7S: ±22</td> <td></td> </tr> <tr> <td>X7T: +22, -33</td> <td></td> </tr> </tbody> </table>	Capacitance Change (%)		No voltage applied	With voltage applied	J B: ±10	J B: +10,-30 +10,-50 +10,-60	X5R: ±15		X6S: ±22		X7R: ±15	---	X7S: ±22		X7T: +22, -33		<p>Capacitance shall be measured by the steps shown in the following table after thermal equilibrium is obtained for each step.</p> <p>ΔC be calculated ref. STEP3 reading</p> <table border="1" data-bbox="970 712 1409 969"> <thead> <tr> <th>Step</th> <th>Temperature(°C)</th> </tr> </thead> <tbody> <tr> <td>1</td> <td>Reference temp. ± 2</td> </tr> <tr> <td>2</td> <td>Min. operating temp. ± 2</td> </tr> <tr> <td>3</td> <td>Reference temp. ± 2</td> </tr> <tr> <td>4</td> <td>Max. operating temp. ± 2</td> </tr> </tbody> </table> <p>Measuring voltage: 0.1, 0.2, 0.5, 1.0Vrms. For information which product has which applied voltage, please contact with our sales representative.</p>	Step	Temperature(°C)	1	Reference temp. ± 2	2	Min. operating temp. ± 2	3	Reference temp. ± 2	4	Max. operating temp. ± 2
Capacitance Change (%)																													
No voltage applied	With voltage applied																												
J B: ±10	J B: +10,-30 +10,-50 +10,-60																												
X5R: ±15																													
X6S: ±22																													
X7R: ±15	---																												
X7S: ±22																													
X7T: +22, -33																													
Step	Temperature(°C)																												
1	Reference temp. ± 2																												
2	Min. operating temp. ± 2																												
3	Reference temp. ± 2																												
4	Max. operating temp. ± 2																												
9	Robustness of Terminations	No sign of termination coming off, breakage of ceramic, or other abnormal signs.	<p>Reflow solder the capacitors on a P.C.Board shown in Appendix 1a or Appendix 1b and apply a pushing force of 2N (C0603, C1005) or 5N (C1608, C2012, C3216, C3225, C4532, C5750) with 10±1s. (Not applicable to C0402.)</p> 																										
10	Bending	No mechanical damage.	<p>Reflow solder the capacitors on a P.C.Board shown in Appendix 2a or Appendix 2b and bend it for 1mm.</p>  <p>(Unit : mm)</p>																										

(continued)

No.	Item	Performance	Test or inspection method
11	Solderability	<p>(C0402)</p> <p>Both end faces and the contact areas shall be covered with a smooth and bright solder coating with no more than a small amount of scattered imperfections such as pinholes or un-wetted or de-wetted areas. These imperfections shall not be concentrated in one area.</p> <p>(Others)</p> <p>New solder to cover over 75% of termination. 25% may have pin holes or rough spots but not concentrated in one spot. Ceramic surface of A sections shall not be exposed due to melting or shifting of termination material.</p> 	<p>Completely soak both terminations in solder at the following conditions.</p> <p>Solder : Sn-3.0Ag-0.5Cu or Sn-37Pb Temperature: 245±5°C (Sn-3.0Ag-0.5Cu) 235±5°C (Sn-37Pb) Soaking time: 3±0.3s (Sn-3.0Ag-0.5Cu) 2±0.2s (Sn-37Pb)</p> <p>Flux: Isopropyl alcohol (JIS K 8839) Rosin (JIS K 5902) 25% solid solution.</p> <p>Only reflow soldering applicable to C0402.</p> <p>Peak condition Temp. : 235±5°C Time : 2±0.5s.</p> <p>Preheating condition Temp. : 110 to 140°C Time : 30 to 60s.</p>

(continued)

No.	Item		Performance		Test or inspection method									
12	Resistance to solder heat	External appearance	No cracks are allowed and terminations shall be covered at least 60% with new solder.		<p>Completely soak both terminations in solder at the following conditions.</p> <p>260±5°C for 10±1s.</p> <p>Preheating condition Temp. : 110 to 140°C Time : 30 to 60s.</p> <p>Solder : Sn-3.0Ag-0.5Cu or Sn-37Pb</p> <p>Flux : Isopropyl alcohol (JIS K 8839) Rosin (JIS K 5902) 25% solid solution.</p> <p>Leave the capacitors in ambient condition for 6 to 24h (Class1) or 24±2h (Class2) before measurement.</p> <p>Only reflow soldering applicable to C0402.</p> <p>Peak condition Temp. : 260°C Time : 5±0.5s.</p> <p>Preheating condition Temp. : 110 to 140°C Time : 30 to 60s.</p>									
		Capacitance	<table border="1"> <thead> <tr> <th colspan="2" data-bbox="560 383 730 443">Characteristics</th> <th data-bbox="735 383 948 443">Change from the value before test</th> </tr> </thead> <tbody> <tr> <td data-bbox="560 450 651 562">Class1</td> <td data-bbox="655 450 730 562">C H C0G</td> <td data-bbox="735 450 948 562">Capacitance drift within ±2.5% or ±0.25pF, whichever larger.</td> </tr> <tr> <td data-bbox="560 568 651 741">Class2</td> <td data-bbox="655 568 730 741">J B X5R X6S X7R X7S X7T</td> <td data-bbox="735 568 948 741">± 7.5 %</td> </tr> </tbody> </table>			Characteristics		Change from the value before test	Class1	C H C0G	Capacitance drift within ±2.5% or ±0.25pF, whichever larger.	Class2	J B X5R X6S X7R X7S X7T	± 7.5 %
	Characteristics		Change from the value before test											
	Class1	C H C0G	Capacitance drift within ±2.5% or ±0.25pF, whichever larger.											
	Class2	J B X5R X6S X7R X7S X7T	± 7.5 %											
	Q (Class1)	Meet the initial spec.												
D.F. (Class2)	Meet the initial spec.													
Insulation Resistance	Meet the initial spec.													
Voltage proof	No insulation breakdown or other damage.													
13	Vibration	External appearance	No mechanical damage.		<p>Reflow solder the capacitors on a P.C.Board shown in Appendix 1a or Appendix 1b before testing.</p> <p>Vibrate the capacitors with amplitude of 1.5mm P-P changing the frequencies from 10Hz to 55Hz and back to 10Hz in about 1min. Repeat this for 2h each in 3 perpendicular directions.</p>									
		Capacitance	<table border="1"> <thead> <tr> <th colspan="2" data-bbox="560 1413 730 1473">Characteristics</th> <th data-bbox="735 1413 948 1473">Change from the value before test</th> </tr> </thead> <tbody> <tr> <td data-bbox="560 1480 651 1592">Class1</td> <td data-bbox="655 1480 730 1592">C H C0G</td> <td data-bbox="735 1480 948 1592">±2.5% or ±0.25pF, whichever larger.</td> </tr> <tr> <td data-bbox="560 1599 651 1711">Class2</td> <td data-bbox="655 1599 730 1711">J B X5R X6S X7R X7S X7T</td> <td data-bbox="735 1599 948 1711">± 7.5 %</td> </tr> </tbody> </table>			Characteristics		Change from the value before test	Class1	C H C0G	±2.5% or ±0.25pF, whichever larger.	Class2	J B X5R X6S X7R X7S X7T	± 7.5 %
		Characteristics		Change from the value before test										
		Class1	C H C0G	±2.5% or ±0.25pF, whichever larger.										
Class2	J B X5R X6S X7R X7S X7T	± 7.5 %												
Q (Class1)	Meet the initial spec.													
D.F. (Class2)	Meet the initial spec.													

(continued)

No.	Item		Performance	Test or inspection method						
14	Temperature cycle	External appearance	No mechanical damage.	Reflow solder the capacitors on a P.C.Board shown in Appendix1a or Appendix1b before testing. Expose the capacitors in the condition step1 through step 4 and repeat 5 times consecutively. Leave the capacitors in ambient condition for 6 to 24h (Class 1) or 24±2h (Class 2) before measurement.						
		Capacitance	Characteristics				Change from the value before test			
			Class1				C H C0G	±2.5% or ±0.25pF, whichever larger.		
		Class2	J B X5R X6S X7R X7S X7T				± 7.5 % ± 10 % ± 12.5 %			
			Q (Class1)				Meet the initial spec.		Step	Temperature(°C)
		D.F. (Class2)	Meet the initial spec.				1	Min. operating temp. ± 3	30 ± 3	
Insulation Resistance	Meet the initial spec.		2	Reference Temp.	2 - 5					
Voltage proof	No insulation breakdown or other damage.		3	Max. operating temp. ± 2	30 ± 2					
			4	Reference Temp.	2 - 5					

(continued)

No.	Item		Performance		Test or inspection method								
15	Moisture Resistance (Steady State)	External appearance	No mechanical damage.		Reflow solder the capacitors on a P.C.Board shown in Appendix 1a or Appendix 1b before testing. Leave at temperature $40 \pm 2^{\circ}\text{C}$, 90 to 95%RH for 500 +24,0h. Leave the capacitors in ambient condition for 6 to 24h (Class1) or 24 ± 2 h (Class2) before measurement.								
		Capacitance	<table border="1"> <thead> <tr> <th colspan="2">Characteristics</th> <th>Change from the value before test</th> </tr> </thead> <tbody> <tr> <td data-bbox="555 450 660 528">Class1</td> <td data-bbox="660 450 740 528">C H C0G</td> <td data-bbox="740 450 957 528">$\pm 5\%$ or $\pm 0.5\text{pF}$, whichever larger.</td> </tr> <tr> <td data-bbox="555 528 660 707">Class2</td> <td data-bbox="660 528 740 707">J B X5R X6S X7R X7S X7T</td> <td data-bbox="740 528 957 707"> $\pm 10\%$ $\pm 12.5\%$ $\pm 25\%$ </td> </tr> </tbody> </table>	Characteristics		Change from the value before test	Class1	C H C0G	$\pm 5\%$ or $\pm 0.5\text{pF}$, whichever larger.	Class2	J B X5R X6S X7R X7S X7T	$\pm 10\%$ $\pm 12.5\%$ $\pm 25\%$	
	Characteristics		Change from the value before test										
	Class1	C H C0G	$\pm 5\%$ or $\pm 0.5\text{pF}$, whichever larger.										
	Class2	J B X5R X6S X7R X7S X7T	$\pm 10\%$ $\pm 12.5\%$ $\pm 25\%$										
Q (Class1)	<table border="1"> <thead> <tr> <th>Rated Capacitance</th> <th>Q</th> </tr> </thead> <tbody> <tr> <td data-bbox="555 842 740 887">30pF and over</td> <td data-bbox="772 842 957 887">350 min.</td> </tr> <tr> <td data-bbox="555 887 740 954">10pF and over under 30pF</td> <td data-bbox="772 887 957 954">$275+5/2 \times C$ min.</td> </tr> <tr> <td data-bbox="555 954 740 999">Under 10pF</td> <td data-bbox="772 954 957 999">$200+10 \times C$ min.</td> </tr> </tbody> </table>	Rated Capacitance	Q	30pF and over	350 min.	10pF and over under 30pF	$275+5/2 \times C$ min.	Under 10pF	$200+10 \times C$ min.	C : Rated capacitance (pF)			
Rated Capacitance	Q												
30pF and over	350 min.												
10pF and over under 30pF	$275+5/2 \times C$ min.												
Under 10pF	$200+10 \times C$ min.												
D.F. (Class2)	200% of initial spec. max.												
Insulation Resistance	1,000M Ω or 50M Ω · μF min. (As for the capacitors of rated voltage 16, 10V DC and lower, 1,000 M Ω or 10M Ω · μF min.,) whichever smaller.												

(continued)

No.	Item		Performance	Test or inspection method																
16	Moisture Resistance	External appearance	No mechanical damage.	Reflow solder the capacitors on a P.C.Board shown in Appendix1a or Appendix 1b before testing. Apply the rated voltage at temperature $40\pm 2^{\circ}\text{C}$ and 90 to 95%RH for 500 +24,0h. Charge/discharge current shall not exceed 50mA. Leave the capacitors in ambient condition for 6 to 24h (Class1) or $24\pm 2\text{h}$ (Class2) before measurement. Voltage conditioning (only for class 2) Voltage treat the capacitors under testing temperature and voltage for 1 hour. Leave the capacitors in ambient condition for $24\pm 2\text{h}$ before measurement. Use this measurement for initial value.																
		Capacitance	<table border="1" data-bbox="549 376 957 701"> <thead> <tr> <th colspan="2" data-bbox="549 376 740 443">Characteristics</th> <th data-bbox="740 376 957 443">Change from the value before test</th> </tr> </thead> <tbody> <tr> <td data-bbox="549 443 655 521">Class1</td> <td data-bbox="655 443 740 521">C H C0G</td> <td data-bbox="740 443 957 521">$\pm 7.5\%$ or $\pm 0.75\text{pF}$, whichever larger.</td> </tr> <tr> <td data-bbox="549 521 655 701" rowspan="5">Class2</td> <td data-bbox="655 521 740 555">J B</td> <td data-bbox="740 521 957 555">$\pm 10\%$</td> </tr> <tr> <td data-bbox="655 555 740 589">X5R</td> <td data-bbox="740 555 957 589">$\pm 12.5\%$</td> </tr> <tr> <td data-bbox="655 589 740 622">X6S</td> <td data-bbox="740 589 957 622">$\pm 25\%$</td> </tr> <tr> <td data-bbox="655 622 740 656">X7R</td> <td data-bbox="740 622 957 656">$\pm 10\%$</td> </tr> <tr> <td data-bbox="655 656 740 701">X7S X7T</td> <td data-bbox="740 656 957 701">$\pm 12.5\%$</td> </tr> </tbody> </table>		Characteristics		Change from the value before test	Class1	C H C0G	$\pm 7.5\%$ or $\pm 0.75\text{pF}$, whichever larger.	Class2	J B	$\pm 10\%$	X5R	$\pm 12.5\%$	X6S	$\pm 25\%$	X7R	$\pm 10\%$	X7S X7T
	Characteristics		Change from the value before test																	
	Class1	C H C0G	$\pm 7.5\%$ or $\pm 0.75\text{pF}$, whichever larger.																	
	Class2	J B	$\pm 10\%$																	
X5R		$\pm 12.5\%$																		
X6S		$\pm 25\%$																		
X7R		$\pm 10\%$																		
X7S X7T		$\pm 12.5\%$																		
Q (Class1)	<table border="1" data-bbox="549 790 957 925"> <thead> <tr> <th data-bbox="549 790 767 835">Rated Capacitance</th> <th data-bbox="767 790 957 835">Q</th> </tr> </thead> <tbody> <tr> <td data-bbox="549 835 767 880">30pF and over</td> <td data-bbox="767 835 957 880">200 min.</td> </tr> <tr> <td data-bbox="549 880 767 925">Under 30pF</td> <td data-bbox="767 880 957 925">$100 + 10/3 \times C$ min.</td> </tr> </tbody> </table> <p data-bbox="531 925 863 969">C : Rated capacitance (pF)</p>	Rated Capacitance	Q	30pF and over	200 min.	Under 30pF	$100 + 10/3 \times C$ min.													
Rated Capacitance	Q																			
30pF and over	200 min.																			
Under 30pF	$100 + 10/3 \times C$ min.																			
D.F. (Class2)	200% of initial spec. max.																			
Insulation Resistance	500M Ω or 25M Ω · μF min. (As for the capacitors of rated voltage 16, 10V DC and lower, 500 M Ω or 5M Ω · μF min.,) whichever smaller.																			

(continued)

No.	Item		Performance	Test or inspection method																
17	Life	External appearance	No mechanical damage.	<p>Reflow solder the capacitors on a P.C.Board shown in Appendix1a or Appendix 1b before testing.</p> <p>Below the voltage shall be applied at maximum operating temperature $\pm 2^{\circ}\text{C}$ for 1,000 +48, 0h.</p> <hr/> <p style="text-align: center;">Applied voltage</p> <hr/> <p style="text-align: center;">Rated voltage x2</p> <hr/> <p style="text-align: center;">Rated voltage x1.5</p> <hr/> <p style="text-align: center;">Rated voltage x1.2</p> <hr/> <p style="text-align: center;">Rated voltage x1</p> <hr/> <p>For information which product has which applied voltage, please contact with our sales representative.</p> <p>Charge/discharge current shall not exceed 50mA.</p> <p>Leave the capacitors in ambient condition for 6 to 24h (Class1) or 24\pm2h (Class2) before measurement.</p> <p>Voltage conditioning (only for class 2) Voltage treat the capacitors under testing temperature and voltage for 1 hour.</p> <p>Leave the capacitors in ambient condition for 24\pm2h before measurement.</p> <p>Use this measurement for initial value.</p>																
		Capacitance	<table border="1"> <thead> <tr> <th colspan="2">Characteristics</th> <th>Change from the value before test</th> </tr> </thead> <tbody> <tr> <td>Class1</td> <td>C H C0G</td> <td>$\pm 3\%$ or $\pm 0.3\text{pF}$, whichever larger.</td> </tr> <tr> <td rowspan="5">Class2</td> <td>J B</td> <td rowspan="5">$\pm 10\%$</td> </tr> <tr> <td>X5R</td> </tr> <tr> <td>X6S</td> </tr> <tr> <td>X7R</td> </tr> <tr> <td>X7S</td> </tr> <tr> <td></td> <td>X7T</td> <td>$\pm 25\%$</td> </tr> </tbody> </table>		Characteristics		Change from the value before test	Class1	C H C0G	$\pm 3\%$ or $\pm 0.3\text{pF}$, whichever larger.	Class2	J B	$\pm 10\%$	X5R	X6S	X7R	X7S		X7T	$\pm 25\%$
		Characteristics			Change from the value before test															
		Class1	C H C0G		$\pm 3\%$ or $\pm 0.3\text{pF}$, whichever larger.															
		Class2	J B		$\pm 10\%$															
X5R																				
X6S																				
X7R																				
X7S																				
	X7T	$\pm 25\%$																		
Q (Class1)	<table border="1"> <thead> <tr> <th>Rated Capacitance</th> <th>Q</th> </tr> </thead> <tbody> <tr> <td>30pF and over</td> <td>350 min.</td> </tr> <tr> <td>10pF and over under 30pF</td> <td>$275+5/2 \times C$ min.</td> </tr> <tr> <td>Under 10pF</td> <td>$200+10 \times C$ min.</td> </tr> </tbody> </table> <p>C : Rated capacitance (pF)</p>	Rated Capacitance	Q	30pF and over	350 min.	10pF and over under 30pF	$275+5/2 \times C$ min.	Under 10pF	$200+10 \times C$ min.											
Rated Capacitance	Q																			
30pF and over	350 min.																			
10pF and over under 30pF	$275+5/2 \times C$ min.																			
Under 10pF	$200+10 \times C$ min.																			
D.F. (Class2)	200% of initial spec. max.																			
Insulation Resistance	1,000M Ω or 50M $\Omega \cdot \mu\text{F}$ min. (As for the capacitors of rated voltage 16, 10V DC and lower, 1,000 M Ω or 10M $\Omega \cdot \mu\text{F}$ min.,) whichever smaller.																			

*As for the initial measurement of capacitors (Class2) on number 8,12,13,14 and 15, leave capacitors at 150 -10,0 $^{\circ}\text{C}$ for 1 hour and measure the value after leaving capacitors for 24 \pm 2h in ambient condition.

Appendix - 1a

P.C. Board for reliability test

Applied for C0402, C0603, C1005, C1608, C2012, C3216



Appendix - 1b

P.C. Board for reliability test

Applied for C3225, C4532, C5750



Appendix - 2a

P.C. Board for bending test

Applied for C0402, C0603, C1005



Appendix - 2b

P.C. Board for bending test

Applied for C1608, C2012, C3216, C3225, C4532, C5750



Material : Glass Epoxy (As per JIS C6484 GE4)

P.C. Board thickness : Appendix-2a 0.8mm

Appendix-1a, 1b, 2b 1.6mm

- Copper (thickness 0.035mm)
- Solder resist

TDK (EIA style)	Dimensions (mm)		
	a	b	c
C0402 (CC01005)	0.2	0.8	0.2
C0603 (CC0201)	0.3	0.8	0.3
C1005 (CC0402)	0.4	1.5	0.5
C1608 (CC0603)	1.0	3.0	1.2
C2012 (CC0805)	1.2	4.0	1.65
C3216 (CC1206)	2.2	5.0	2.0
C3225 (CC1210)	2.2	5.0	2.9
C4532 (CC1812)	3.5	7.0	3.7
C5750 (CC2220)	4.5	8.0	5.6

9. INSIDE STRUCTURE AND MATERIAL

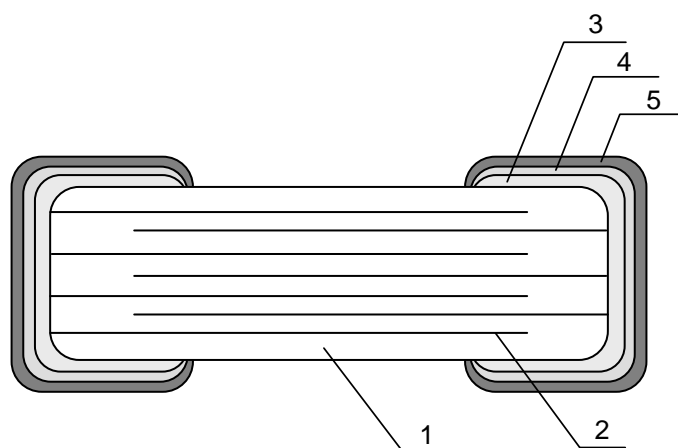

No.	NAME	MATERIAL	
		Class1	Class2
1	Dielectric	CaZrO ₃	BaTiO ₃
2	Electrode	Nickel (Ni)	
3	Termination	Copper (Cu)	
4		Nickel (Ni)	
5		Tin (Sn)	

10. RECOMMENDATION

As for C3225, C4532 and C5750 types, It is recommended to provide a slit (about 1mm wide) in the board under the components to improve washing Flux. And please make sure to dry detergent up completely before.

11. SOLDERING CONDITION

As for C0402, C0603, C1005, C3225, C4532 and C5750 types, reflow soldering only.

12. CAUTION

No.	Process	Condition														
1	Operating Condition (Storage, Transportation)	<p>1-1. Storage</p> <ol style="list-style-type: none"> The capacitors must be stored in an ambient temperature of 5 to 40°C with a relative humidity of 20 to 70%RH. The products should be used within 6 months upon receipt. The capacitors must be operated and stored in an environment free of dew condensation and these gases such as Hydrogen Sulphide, Hydrogen Sulphate, Chlorine, Ammonia and sulfur. Avoid storing in sun light and falling of dew. Do not use capacitors under high humidity and high and low atmospheric pressure which may affect capacitors reliability. Capacitors should be tested for the solderability when they are stored for long time. <p>1-2. Handling in transportation</p> <p>In case of the transportation of the capacitors, the performance of the capacitors may be deteriorated depending on the transportation condition. (Refer to JEITA RCR-2335C 9.2 Handling in transportation)</p>														
2	Circuit design  Caution	<p>2-1. Operating temperature</p> <p>Operating temperature should be followed strictly within this specification, especially be careful with maximum temperature.</p> <ol style="list-style-type: none"> Do not use capacitors above the maximum allowable operating temperature. Surface temperature including self heating should be below maximum operating temperature. (Due to dielectric loss, capacitors will heat itself when AC is applied. Especially at high frequencies around its SRF, the heat might be so extreme that it may damage itself or the product mounted on. Please design the circuit so that the maximum temperature of the capacitors including the self heating to be below the maximum allowable operating temperature. Temperature rise at capacitor surface shall be below 20°C) The electrical characteristics of the capacitors will vary depending on the temperature. The capacitors should be selected and designed in taking the temperature into consideration. <p>2-2 Operating voltage</p> <ol style="list-style-type: none"> Operating voltage across the terminals should be below the rated voltage. When AC and DC are super imposed, V_{0-P} must be below the rated voltage. _____ (1) and (2) AC or pulse with overshooting, V_{P-P} must be below the rated voltage. _____ (3), (4) and (5) When the voltage is started to apply to the circuit or it is stopped applying, the irregular voltage may be generated for a transit period because of resonance or switching. Be sure to use the capacitors within rated voltage containing these Irregular voltage. <table border="1" data-bbox="507 1480 1449 1753"> <thead> <tr> <th data-bbox="507 1480 679 1518">Voltage</th> <th data-bbox="679 1480 938 1518">(1) DC voltage</th> <th data-bbox="938 1480 1197 1518">(2) DC + AC voltage</th> <th data-bbox="1197 1480 1449 1518">(3) AC voltage</th> </tr> </thead> <tbody> <tr> <td data-bbox="507 1518 679 1753">Positional Measurement (Rated voltage)</td> <td data-bbox="679 1518 938 1753">  </td> <td data-bbox="938 1518 1197 1753">  </td> <td data-bbox="1197 1518 1449 1753">  </td> </tr> </tbody> </table> <table border="1" data-bbox="507 1771 1198 2040"> <thead> <tr> <th data-bbox="507 1771 679 1809">Voltage</th> <th data-bbox="679 1771 938 1809">(4) Pulse voltage (A)</th> <th data-bbox="938 1771 1198 1809">(5) Pulse voltage (B)</th> </tr> </thead> <tbody> <tr> <td data-bbox="507 1809 679 2040">Positional Measurement (Rated voltage)</td> <td data-bbox="679 1809 938 2040">  </td> <td data-bbox="938 1809 1198 2040">  </td> </tr> </tbody> </table>	Voltage	(1) DC voltage	(2) DC + AC voltage	(3) AC voltage	Positional Measurement (Rated voltage)				Voltage	(4) Pulse voltage (A)	(5) Pulse voltage (B)	Positional Measurement (Rated voltage)		
Voltage	(1) DC voltage	(2) DC + AC voltage	(3) AC voltage													
Positional Measurement (Rated voltage)																
Voltage	(4) Pulse voltage (A)	(5) Pulse voltage (B)														
Positional Measurement (Rated voltage)																

No.	Process	Condition																																																												
2	Circuit design ⚠ Caution	<p>2) Even below the rated voltage, if repetitive high frequency AC or pulse is applied, the reliability of the capacitors may be reduced.</p> <p>3) The effective capacitance will vary depending on applied DC and AC voltages. The capacitors should be selected and designed in taking the voltages into consideration.</p> <p>2-3. Frequency When the capacitors (Class 2) are used in AC and/or pulse voltages, the capacitors may vibrate themselves and generate audible sound.</p>																																																												
3	Designing P.C. board	<p>The amount of solder at the terminations has a direct effect on the reliability of the capacitors.</p> <p>1) The greater the amount of solder, the higher the stress on the chip capacitor, and the more likely that it will break. When designing a P.C. board, determine the shape and size of the solder lands to have proper amount of solder on the terminations.</p> <p>2) Avoid using common solder land for multiple terminations and provide individual solder land for each terminations.</p> <p>3) Size and recommended land dimensions.</p> <div style="text-align: center;"> </div> <p>• Flow soldering (mm)</p> <table border="1"> <thead> <tr> <th>Type</th> <th>C1608 (CC0603)</th> <th>C2012 (CC0805)</th> <th>C3216 (CC1206)</th> </tr> </thead> <tbody> <tr> <td>A</td> <td>0.7 - 1.0</td> <td>1.0 - 1.3</td> <td>2.1 - 2.5</td> </tr> <tr> <td>B</td> <td>0.8 - 1.0</td> <td>1.0 - 1.2</td> <td>1.1 - 1.3</td> </tr> <tr> <td>C</td> <td>0.6 - 0.8</td> <td>0.8 - 1.1</td> <td>1.0 - 1.3</td> </tr> </tbody> </table> <p>• Reflow soldering (mm)</p> <table border="1"> <thead> <tr> <th>Type</th> <th>C0402 (CC01005)</th> <th>C0603 (CC0201)</th> <th>C1005 (CC0402)</th> <th>C1608 (CC0603)</th> <th>C2012 (CC0805)</th> </tr> </thead> <tbody> <tr> <td>A</td> <td>0.15 - 0.25</td> <td>0.25 - 0.35</td> <td>0.3 - 0.5</td> <td>0.6 - 0.8</td> <td>0.9 - 1.2</td> </tr> <tr> <td>B</td> <td>0.15 - 0.25</td> <td>0.2 - 0.3</td> <td>0.35 - 0.45</td> <td>0.6 - 0.8</td> <td>0.7 - 0.9</td> </tr> <tr> <td>C</td> <td>0.15 - 0.25</td> <td>0.25 - 0.35</td> <td>0.4 - 0.6</td> <td>0.6 - 0.8</td> <td>0.9 - 1.2</td> </tr> </tbody> </table> <table border="1"> <thead> <tr> <th>Type</th> <th>C3216 (CC1206)</th> <th>C3225 (CC1210)</th> <th>C4532 (CC1812)</th> <th>C5750 (CC2220)</th> </tr> </thead> <tbody> <tr> <td>A</td> <td>2.0 - 2.4</td> <td>2.0 - 2.4</td> <td>3.1 - 3.7</td> <td>4.1 - 4.8</td> </tr> <tr> <td>B</td> <td>1.0 - 1.2</td> <td>1.0 - 1.2</td> <td>1.2 - 1.4</td> <td>1.2 - 1.4</td> </tr> <tr> <td>C</td> <td>1.1 - 1.6</td> <td>1.9 - 2.5</td> <td>2.4 - 3.2</td> <td>4.0 - 5.0</td> </tr> </tbody> </table>	Type	C1608 (CC0603)	C2012 (CC0805)	C3216 (CC1206)	A	0.7 - 1.0	1.0 - 1.3	2.1 - 2.5	B	0.8 - 1.0	1.0 - 1.2	1.1 - 1.3	C	0.6 - 0.8	0.8 - 1.1	1.0 - 1.3	Type	C0402 (CC01005)	C0603 (CC0201)	C1005 (CC0402)	C1608 (CC0603)	C2012 (CC0805)	A	0.15 - 0.25	0.25 - 0.35	0.3 - 0.5	0.6 - 0.8	0.9 - 1.2	B	0.15 - 0.25	0.2 - 0.3	0.35 - 0.45	0.6 - 0.8	0.7 - 0.9	C	0.15 - 0.25	0.25 - 0.35	0.4 - 0.6	0.6 - 0.8	0.9 - 1.2	Type	C3216 (CC1206)	C3225 (CC1210)	C4532 (CC1812)	C5750 (CC2220)	A	2.0 - 2.4	2.0 - 2.4	3.1 - 3.7	4.1 - 4.8	B	1.0 - 1.2	1.0 - 1.2	1.2 - 1.4	1.2 - 1.4	C	1.1 - 1.6	1.9 - 2.5	2.4 - 3.2	4.0 - 5.0
Type	C1608 (CC0603)	C2012 (CC0805)	C3216 (CC1206)																																																											
A	0.7 - 1.0	1.0 - 1.3	2.1 - 2.5																																																											
B	0.8 - 1.0	1.0 - 1.2	1.1 - 1.3																																																											
C	0.6 - 0.8	0.8 - 1.1	1.0 - 1.3																																																											
Type	C0402 (CC01005)	C0603 (CC0201)	C1005 (CC0402)	C1608 (CC0603)	C2012 (CC0805)																																																									
A	0.15 - 0.25	0.25 - 0.35	0.3 - 0.5	0.6 - 0.8	0.9 - 1.2																																																									
B	0.15 - 0.25	0.2 - 0.3	0.35 - 0.45	0.6 - 0.8	0.7 - 0.9																																																									
C	0.15 - 0.25	0.25 - 0.35	0.4 - 0.6	0.6 - 0.8	0.9 - 1.2																																																									
Type	C3216 (CC1206)	C3225 (CC1210)	C4532 (CC1812)	C5750 (CC2220)																																																										
A	2.0 - 2.4	2.0 - 2.4	3.1 - 3.7	4.1 - 4.8																																																										
B	1.0 - 1.2	1.0 - 1.2	1.2 - 1.4	1.2 - 1.4																																																										
C	1.1 - 1.6	1.9 - 2.5	2.4 - 3.2	4.0 - 5.0																																																										

No.	Process	Condition												
3	Designing P.C.board	<p data-bbox="432 210 1098 241">4) Recommended chip capacitor layout is as following.</p> <table border="1" data-bbox="475 277 1423 1697"> <thead> <tr> <th data-bbox="475 277 647 356"></th> <th data-bbox="647 277 1034 356">Disadvantage against bending stress</th> <th data-bbox="1034 277 1423 356">Advantage against bending stress</th> </tr> </thead> <tbody> <tr> <td data-bbox="475 356 647 772">Mounting face</td> <td data-bbox="647 356 1034 772"> <p data-bbox="740 405 943 434">Perforation or slit</p>  <p data-bbox="683 665 935 732">Break P.C.board with mounted side up.</p> </td> <td data-bbox="1034 356 1423 772"> <p data-bbox="1126 405 1329 434">Perforation or slit</p>  <p data-bbox="1082 665 1334 732">Break P.C.board with mounted side down.</p> </td> </tr> <tr> <td data-bbox="475 772 647 1220">Chip arrangement (Direction)</td> <td data-bbox="647 772 1034 1220"> <p data-bbox="740 893 943 922">Perforation or slit</p>  </td> <td data-bbox="1034 772 1423 1220"> <p data-bbox="1126 893 1329 922">Perforation or slit</p>  </td> </tr> <tr> <td data-bbox="475 1220 647 1697">Distance from slit</td> <td data-bbox="647 1220 1034 1697"> <p data-bbox="692 1229 948 1292">Closer to slit is higher stress</p>  <p data-bbox="863 1599 984 1630">$(l_1 < l_2)$</p> </td> <td data-bbox="1034 1220 1423 1697"> <p data-bbox="1075 1229 1331 1292">Away from slit is less stress</p>  <p data-bbox="1256 1599 1377 1630">$(l_1 < l_2)$</p> </td> </tr> </tbody> </table>		Disadvantage against bending stress	Advantage against bending stress	Mounting face	<p data-bbox="740 405 943 434">Perforation or slit</p>  <p data-bbox="683 665 935 732">Break P.C.board with mounted side up.</p>	<p data-bbox="1126 405 1329 434">Perforation or slit</p>  <p data-bbox="1082 665 1334 732">Break P.C.board with mounted side down.</p>	Chip arrangement (Direction)	<p data-bbox="740 893 943 922">Perforation or slit</p> 	<p data-bbox="1126 893 1329 922">Perforation or slit</p> 	Distance from slit	<p data-bbox="692 1229 948 1292">Closer to slit is higher stress</p>  <p data-bbox="863 1599 984 1630">$(l_1 < l_2)$</p>	<p data-bbox="1075 1229 1331 1292">Away from slit is less stress</p>  <p data-bbox="1256 1599 1377 1630">$(l_1 < l_2)$</p>
	Disadvantage against bending stress	Advantage against bending stress												
Mounting face	<p data-bbox="740 405 943 434">Perforation or slit</p>  <p data-bbox="683 665 935 732">Break P.C.board with mounted side up.</p>	<p data-bbox="1126 405 1329 434">Perforation or slit</p>  <p data-bbox="1082 665 1334 732">Break P.C.board with mounted side down.</p>												
Chip arrangement (Direction)	<p data-bbox="740 893 943 922">Perforation or slit</p> 	<p data-bbox="1126 893 1329 922">Perforation or slit</p> 												
Distance from slit	<p data-bbox="692 1229 948 1292">Closer to slit is higher stress</p>  <p data-bbox="863 1599 984 1630">$(l_1 < l_2)$</p>	<p data-bbox="1075 1229 1331 1292">Away from slit is less stress</p>  <p data-bbox="1256 1599 1377 1630">$(l_1 < l_2)$</p>												

No.	Process	Condition												
3	Designing P.C.board	<p>5) Mechanical stress varies according to location of chip capacitors on the P.C.board.</p>  <p>The stress in capacitors is in the following order. $A > B = C > D > E$</p> <p>6) Layout recommendation</p> <table border="1" data-bbox="408 981 1505 1872"> <thead> <tr> <th data-bbox="408 981 563 1099">Example</th> <th data-bbox="563 981 863 1099">Use of common solder land</th> <th data-bbox="863 981 1169 1099">Soldering with chassis</th> <th data-bbox="1169 981 1505 1099">Use of common solder land with other SMD</th> </tr> </thead> <tbody> <tr> <td data-bbox="408 1099 563 1485">Need to avoid</td> <td data-bbox="563 1099 863 1485">  </td> <td data-bbox="863 1099 1169 1485">  </td> <td data-bbox="1169 1099 1505 1485">  </td> </tr> <tr> <td data-bbox="408 1485 563 1872">Recommendation</td> <td data-bbox="563 1485 863 1872">  </td> <td data-bbox="863 1485 1169 1872">  </td> <td data-bbox="1169 1485 1505 1872">  </td> </tr> </tbody> </table>	Example	Use of common solder land	Soldering with chassis	Use of common solder land with other SMD	Need to avoid				Recommendation			
Example	Use of common solder land	Soldering with chassis	Use of common solder land with other SMD											
Need to avoid														
Recommendation														

No.	Process	Condition																	
4	Mounting	<p>4-1. Stress from mounting head If the mounting head is adjusted too low, it may induce excessive stress in the chip capacitor to result in cracking. Please take following precautions.</p> <ol style="list-style-type: none"> 1) Adjust the bottom dead center of the mounting head to reach on the P.C.board surface and not press it. 2) Adjust the mounting head pressure to be 1 to 3N of static weight. 3) To minimize the impact energy from mounting head, it is important to provide support from the bottom side of the P.C.board. See following examples. <table border="1" data-bbox="480 611 1433 1173"> <thead> <tr> <th></th> <th data-bbox="646 611 1038 663">Not recommended</th> <th data-bbox="1038 611 1433 663">Recommended</th> </tr> </thead> <tbody> <tr> <td data-bbox="480 663 646 909">Single sided mounting</td> <td data-bbox="646 663 1038 909">  </td> <td data-bbox="1038 663 1433 909">  </td> </tr> <tr> <td data-bbox="480 909 646 1173">Double-sides mounting</td> <td data-bbox="646 909 1038 1173">  </td> <td data-bbox="1038 909 1433 1173">  </td> </tr> </tbody> </table> <p>When the centering jaw is worn out, it may give mechanical impact on the capacitors to cause crack. Please control the close up dimension of the centering jaw and provide sufficient preventive maintenance and replacement of it.</p> <p>4-2. Amount of adhesive</p>  <table border="1" data-bbox="662 1753 1217 1962"> <thead> <tr> <th colspan="2" data-bbox="662 1753 1217 1794">Example : C2012 (CC0805), C3216 (CC1206)</th> </tr> </thead> <tbody> <tr> <td data-bbox="662 1794 810 1854">a</td> <td data-bbox="810 1794 1217 1854">0.2mm min.</td> </tr> <tr> <td data-bbox="662 1854 810 1906">b</td> <td data-bbox="810 1854 1217 1906">70 - 100μm</td> </tr> <tr> <td data-bbox="662 1906 810 1962">c</td> <td data-bbox="810 1906 1217 1962">Do not touch the solder land</td> </tr> </tbody> </table>		Not recommended	Recommended	Single sided mounting			Double-sides mounting			Example : C2012 (CC0805), C3216 (CC1206)		a	0.2mm min.	b	70 - 100μm	c	Do not touch the solder land
	Not recommended	Recommended																	
Single sided mounting																			
Double-sides mounting																			
Example : C2012 (CC0805), C3216 (CC1206)																			
a	0.2mm min.																		
b	70 - 100μm																		
c	Do not touch the solder land																		

No.	Process	Condition																			
5	Soldering	<p>5-1. Flux selection</p> <p>Although highly-activated flux gives better solderability, substances which increase activity may also degrade the insulation of the chip capacitors.</p> <p>To avoid such degradation, it is recommended following.</p> <ol style="list-style-type: none"> 1) It is recommended to use a mildly activated rosin flux (less than 0.1wt% chlorine). Strong flux is not recommended. 2) Excessive flux must be avoided. Please provide proper amount of flux. 3) When water-soluble flux is used, enough washing is necessary. <p>5-2. Recommended soldering profile by various methods</p> <div style="display: flex; justify-content: space-around;"> <div style="text-align: center;"> <p>Wave soldering</p>  </div> <div style="text-align: center;"> <p>Reflow soldering</p>  </div> </div> <div style="text-align: center; margin-top: 20px;"> <p>Manual soldering (Solder iron)</p>  </div> <div style="margin-top: 20px;"> <p>APPLICATION</p> <p>As for C1608, C2012 and C3216 applied to wave soldering and reflow soldering.</p> <p>As for C0402, C0603, C1005, C3225, C4532, C5750 applied only to reflow soldering.</p> </div> <p>*As for peak temperature of manual soldering, please refer "5-6. Solder repair by solder iron"</p> <p>5-3. Recommended soldering peak temp and peak temp duration</p> <table border="1" style="width: 100%; border-collapse: collapse; text-align: center;"> <thead> <tr> <th rowspan="2"></th> <th colspan="2">Wave soldering</th> <th colspan="2">Reflow soldering</th> </tr> <tr> <th>Peak temp(°C)</th> <th>Duration(sec.)</th> <th>Peak temp(°C)</th> <th>Duration(sec.)</th> </tr> </thead> <tbody> <tr> <td>Sn-Pb Solder</td> <td>250 max.</td> <td>3 max.</td> <td>230 max.</td> <td>20 max.</td> </tr> <tr> <td>Lead Free Solder</td> <td>260 max.</td> <td>5 max.</td> <td>260 max.</td> <td>10 max.</td> </tr> </tbody> </table> <p>Recommended solder compositions Sn-37Pb (Sn-Pb solder) Sn-3.0Ag-0.5Cu (Lead Free Solder)</p>		Wave soldering		Reflow soldering		Peak temp(°C)	Duration(sec.)	Peak temp(°C)	Duration(sec.)	Sn-Pb Solder	250 max.	3 max.	230 max.	20 max.	Lead Free Solder	260 max.	5 max.	260 max.	10 max.
	Wave soldering			Reflow soldering																	
	Peak temp(°C)	Duration(sec.)	Peak temp(°C)	Duration(sec.)																	
Sn-Pb Solder	250 max.	3 max.	230 max.	20 max.																	
Lead Free Solder	260 max.	5 max.	260 max.	10 max.																	

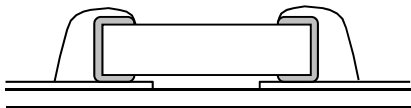
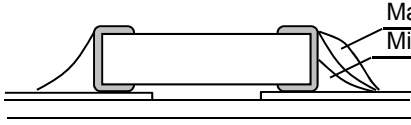
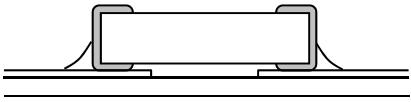
No.	Process	Condition																										
5	Soldering	<p>5-4. Avoiding thermal shock</p> <p>1) Preheating condition</p> <table border="1" data-bbox="555 259 1430 622"> <thead> <tr> <th>Soldering</th> <th>Type</th> <th>Temp. (°C)</th> </tr> </thead> <tbody> <tr> <td>Wave soldering</td> <td>C1608, C2012, C3216</td> <td>$\Delta T \leq 150$</td> </tr> <tr> <td rowspan="2">Reflow soldering</td> <td>C0402, C0603, C1005, C1608, C2012, C3216</td> <td>$\Delta T \leq 150$</td> </tr> <tr> <td>C3225, C4532, C5750</td> <td>$\Delta T \leq 130$</td> </tr> <tr> <td rowspan="2">Manual soldering</td> <td>C0402, C0603, C1005, C1608, C2012, C3216</td> <td>$\Delta T \leq 150$</td> </tr> <tr> <td>C3225, C4532, C5750</td> <td>$\Delta T \leq 130$</td> </tr> </tbody> </table> <p>2) Cooling condition Natural cooling using air is recommended. If the chips are dipped into a solvent for cleaning, the temperature difference (ΔT) must be less than 100°C.</p> <p>5-5. Amount of solder Excessive solder will induce higher tensile force in chip capacitors when temperature changes and it may result in chip cracking. In sufficient solder may detach the capacitors from the P.C.board.</p> <div style="display: flex; justify-content: space-between; align-items: flex-start;"> <div style="text-align: center;"> <p>Excessive solder</p>  </div> <div style="text-align: center;"> <p>Higher tensile force in chip capacitor to cause crack</p> </div> </div> <hr/> <div style="display: flex; justify-content: space-between; align-items: center;"> <div style="text-align: center;"> <p>Adequate</p>  </div> </div> <hr/> <div style="display: flex; justify-content: space-between; align-items: flex-start;"> <div style="text-align: center;"> <p>Insufficient solder</p>  </div> <div style="text-align: center;"> <p>Low robustness may cause contact failure or chip capacitor comes off the P.C.board.</p> </div> </div> <hr/> <p>5-6. Solder repair by solder iron</p> <p>1) Selection of the soldering iron tip Tip temperature of solder iron varies by its type, P.C.board material and solder land size. The higher the tip temperature, the quicker the operation. However, heat shock may cause a crack in the chip capacitors. Please make sure the tip temp. before soldering and keep the peak temp and time in accordance with following recommended condition. (Please preheat the chip capacitors with the condition in 5-4 to avoid the thermal shock.)</p> <p style="text-align: center;"><u>Recommended solder iron condition (Sn-Pb Solder and Lead Free Solder)</u></p> <table border="1" data-bbox="497 1675 1390 2011"> <thead> <tr> <th>Type</th> <th>Temp. (°C)</th> <th>Wattage (W)</th> <th>Shape (mm)</th> </tr> </thead> <tbody> <tr> <td>C0603(CC0201) C1005(CC0402) C1608(CC0603) C2012(CC0805) C3216(CC1206)</td> <td>350 max.</td> <td rowspan="2">20 max.</td> <td rowspan="2">ϕ 3.0 max.</td> </tr> <tr> <td>C3225(CC1210) C4520(CC1808) C4532(CC1812) C5750(CC2220)</td> <td>280 max.</td> </tr> </tbody> </table>	Soldering	Type	Temp. (°C)	Wave soldering	C1608, C2012, C3216	$\Delta T \leq 150$	Reflow soldering	C0402, C0603, C1005, C1608, C2012, C3216	$\Delta T \leq 150$	C3225, C4532, C5750	$\Delta T \leq 130$	Manual soldering	C0402, C0603, C1005, C1608, C2012, C3216	$\Delta T \leq 150$	C3225, C4532, C5750	$\Delta T \leq 130$	Type	Temp. (°C)	Wattage (W)	Shape (mm)	C0603(CC0201) C1005(CC0402) C1608(CC0603) C2012(CC0805) C3216(CC1206)	350 max.	20 max.	ϕ 3.0 max.	C3225(CC1210) C4520(CC1808) C4532(CC1812) C5750(CC2220)	280 max.
Soldering	Type	Temp. (°C)																										
Wave soldering	C1608, C2012, C3216	$\Delta T \leq 150$																										
Reflow soldering	C0402, C0603, C1005, C1608, C2012, C3216	$\Delta T \leq 150$																										
	C3225, C4532, C5750	$\Delta T \leq 130$																										
Manual soldering	C0402, C0603, C1005, C1608, C2012, C3216	$\Delta T \leq 150$																										
	C3225, C4532, C5750	$\Delta T \leq 130$																										
Type	Temp. (°C)	Wattage (W)	Shape (mm)																									
C0603(CC0201) C1005(CC0402) C1608(CC0603) C2012(CC0805) C3216(CC1206)	350 max.	20 max.	ϕ 3.0 max.																									
C3225(CC1210) C4520(CC1808) C4532(CC1812) C5750(CC2220)	280 max.																											

No.	Process	Condition												
5	Soldering	<p>2) Direct contact of the soldering iron with ceramic dielectric of chip capacitors may cause crack. Do not touch the ceramic dielectric and the terminations by solder iron.</p> <p>3) It is not recommended to reuse dismantled capacitors. (For soft electrode)</p> <p>5-7.Soldering rework using spot heater Heat stress during rework may possibly be reduced by using a spot heater (also called a “blower”) rather than a soldering iron. It is applied only to adding solder in the case of insufficient solder amount.</p> <p>1) Reworking using a spot heater may suppress the occurrence of cracks in the capacitor compared to using a soldering iron. A spot heater can heat up a capacitor uniformly with a small heat gradient which leads to lower thermal stress caused by quick heating and cooling or localized heating. Moreover, where ultra-small capacitors are mounted close together on a printed circuit board, reworking with a spot heater can eliminate the risk of direct contact between the tip of a soldering iron and a capacitor.</p> <p>2) Rework condition If the blower nozzle of a spot heater is too close to a capacitor, a crack in the capacitor may occur due to heat stress. Below are recommendations for avoiding such an occurrence. Keep more than 5mm between a capacitor and a spot heater nozzle. The blower temperature of the spot heater shall be lower than 400°C. The airflow shall be set as weak as possible. The diameter of the nozzle is recommended to be 2mm(one-outlet type).The size is standard and common. Duration of blowing hot air is recommended to be 10s or less C1608(CC0603), C2012(CC0805), C3216(CC1206) and 30s or less for C3225(CC1210), C4520(CC1808), C4532(CC1812) and C5750(CC2220), considering surface area of the capacitor and melting temperature of solder. The angle between the nozzle and the capacitor is recommended to be 45degrees in order to work easily and to avoid partial area heating. As is the case when using a soldering iron, preheating reduces thermal stress on capacitors and improves operating efficiency.</p> <p>• Recommended rework condition (Consult the component manufactures for details.)</p> <table border="1" data-bbox="523 1301 1490 1742"> <tbody> <tr> <td data-bbox="523 1301 802 1346">Distance from nozzle</td> <td data-bbox="802 1301 1490 1346">5mm and over</td> </tr> <tr> <td data-bbox="523 1346 802 1391">Nozzle angle</td> <td data-bbox="802 1346 1490 1391">45degrees</td> </tr> <tr> <td data-bbox="523 1391 802 1435">Nozzle temp.</td> <td data-bbox="802 1391 1490 1435">400°C and less</td> </tr> <tr> <td data-bbox="523 1435 802 1570">Airflow</td> <td data-bbox="802 1435 1490 1570">Set as weak as possible (The airflow shall be the minimum value necessary for solder to melt in the Conditions mentioned above.)</td> </tr> <tr> <td data-bbox="523 1570 802 1615">Nozzle diameter</td> <td data-bbox="802 1570 1490 1615">φ2mm (one-outlet type)</td> </tr> <tr> <td data-bbox="523 1615 802 1742">Blowing duration</td> <td data-bbox="802 1615 1490 1742">10s and less (C1608[CC0603], C2012[CC0805], C3216[CC1206]) 30s and less (C3225[CC1210], C4532[CC1812], C5750[CC2220])</td> </tr> </tbody> </table> <p>• Example of recommended spot heater use</p> 	Distance from nozzle	5mm and over	Nozzle angle	45degrees	Nozzle temp.	400°C and less	Airflow	Set as weak as possible (The airflow shall be the minimum value necessary for solder to melt in the Conditions mentioned above.)	Nozzle diameter	φ2mm (one-outlet type)	Blowing duration	10s and less (C1608[CC0603], C2012[CC0805], C3216[CC1206]) 30s and less (C3225[CC1210], C4532[CC1812], C5750[CC2220])
Distance from nozzle	5mm and over													
Nozzle angle	45degrees													
Nozzle temp.	400°C and less													
Airflow	Set as weak as possible (The airflow shall be the minimum value necessary for solder to melt in the Conditions mentioned above.)													
Nozzle diameter	φ2mm (one-outlet type)													
Blowing duration	10s and less (C1608[CC0603], C2012[CC0805], C3216[CC1206]) 30s and less (C3225[CC1210], C4532[CC1812], C5750[CC2220])													

No.	Process	Condition
5	Soldering	<p>3) Amount of solder should be suitable to form a proper fillet shape. Excess solder causes mechanical and thermal stress on a capacitor and results in cracks. Insufficient solder causes weak adherence of the capacitor to the substrate and may result in detachment of a capacitor and deteriorate reliability of the printed wiring board. See the example of appropriate solder fillet shape for 5-5.Amount of solder.</p> <p>5-8. Sn-Zn solder Sn-Zn solder affects product reliability. Please contact TDK in advance when utilize Sn-Zn solder.</p> <p>5-9. Countermeasure for tombstone The misalignment between the mounted positions of the capacitors and the land patterns should be minimized. The tombstone phenomenon may occur especially the capacitors are mounted (in longitudinal direction) in the same direction of the reflow soldering. (Refer to JEITA RCR-2335C Annex A (Informative) Recommendations to prevent the tombstone phenomenon)</p>
6	Cleaning	<p>1) If an unsuitable cleaning fluid is used, flux residue or some foreign articles may stick to chip capacitors surface to deteriorate especially the insulation resistance.</p> <p>2) If cleaning condition is not suitable, it may damage the chip capacitors.</p> <p>2)-1. Insufficient washing (1) Terminal electrodes may corrode by Halogen in the flux. (2) Halogen in the flux may adhere on the surface of capacitors, and lower the insulation resistance. (3) Water soluble flux has higher tendency to have above mentioned problems (1) and (2).</p> <p>2)-2. Excessive washing When ultrasonic cleaning is used, excessively high ultrasonic energy output can affect the connection between the ceramic chip capacitor's body and the terminal electrode. To avoid this, following is the recommended condition. Power : 20W/ℓ max. Frequency : 40kHz max. Washing time : 5 minutes max.</p> <p>2)-3. If the cleaning fluid is contaminated, density of Halogen increases, and it may bring the same result as insufficient cleaning.</p>

No.	Process	Condition				
7	Coating and molding of the P.C. board	<p>1) When the P.C. board is coated, please verify the quality influence on the product.</p> <p>2) Please verify carefully that there is no harmful decomposing or reaction gas emission during curing which may damage the chip capacitors.</p> <p>3) Please verify the curing temperature.</p>				
8	Handling after chip mounted  Caution	<p>1) Please pay attention not to bend or distort the P.C. board after soldering in handling otherwise the chip capacitors may crack.</p> <div style="display: flex; justify-content: space-around; align-items: center;"> <div style="text-align: center;"> <p>Bend</p>  </div> <div style="text-align: center;"> <p>Twist</p>  </div> </div> <p>2) Printed circuit board cropping should not be carried out by hand, but by using the proper tooling. Printed circuit board cropping should be carried out using a board cropping jig as shown in the following figure or a board cropping apparatus to prevent inducing mechanical stress on the board.</p> <p>(1) Example of a board cropping jig</p> <p>Recommended example: The board should be pushed from the back side, close to the cropping jig so that the board is not bent and the stress applied to the capacitor is compressive.</p> <p>Unrecommended example: If the pushing point is far from the cropping jig and the pushing direction is from the front side of the board, large tensile stress is applied to the capacitor, which may cause cracks.</p> <div style="display: flex; justify-content: space-around; align-items: center;"> <div style="text-align: center;"> <p>Outline of jig</p>  </div> <table border="1" style="width: 100%; border-collapse: collapse;"> <thead> <tr> <th style="width: 50%; text-align: center;">Recommended</th> <th style="width: 50%; text-align: center;">Unrecommended</th> </tr> </thead> <tbody> <tr> <td style="text-align: center;">  </td> <td style="text-align: center;">  </td> </tr> </tbody> </table> </div>	Recommended	Unrecommended		
Recommended	Unrecommended					
						

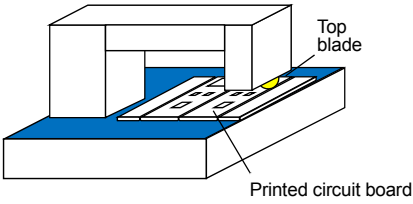
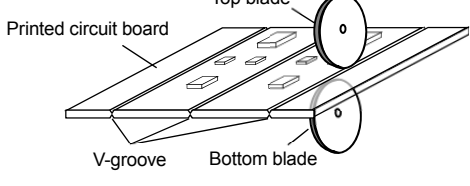
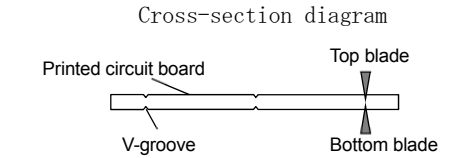
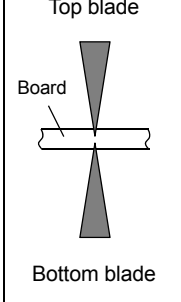
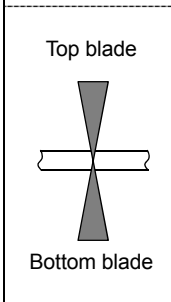
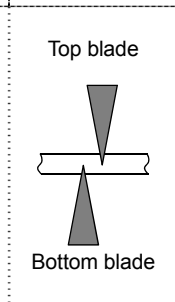
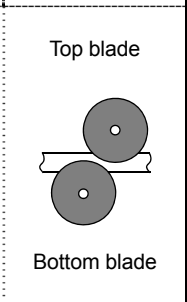
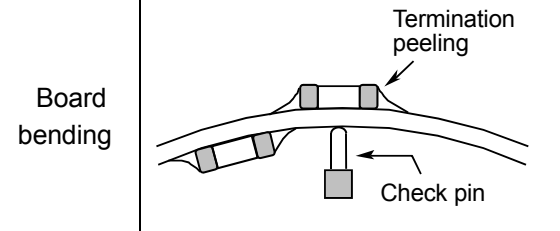
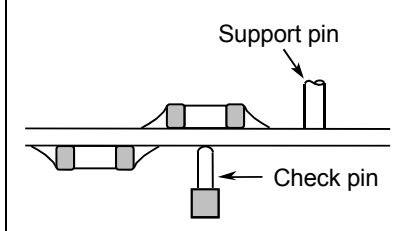
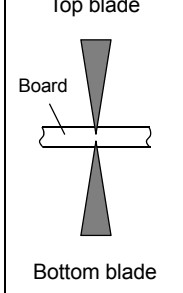
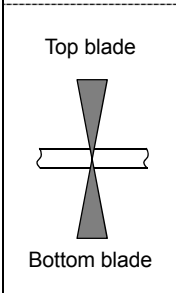
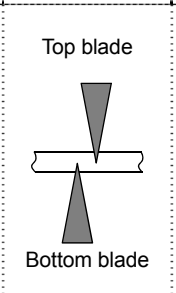
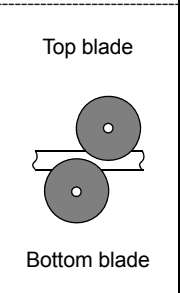
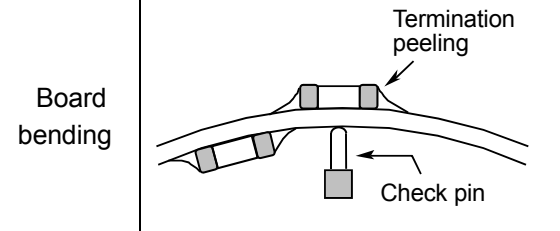
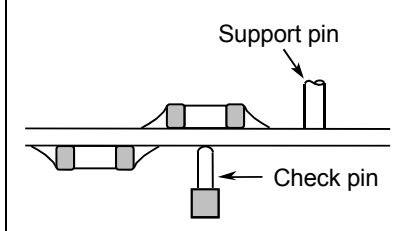
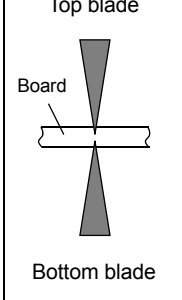
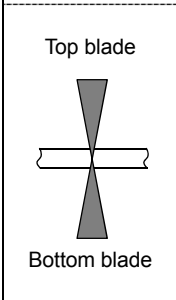
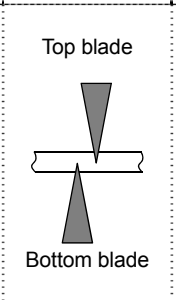
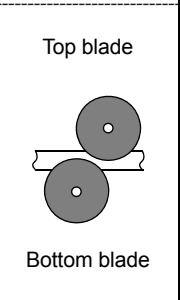
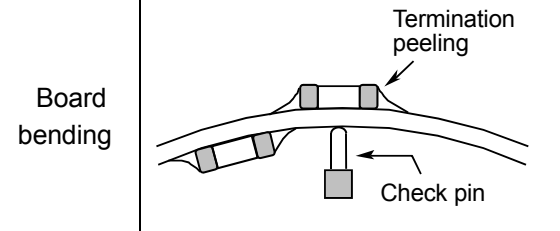
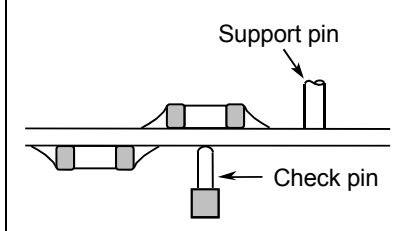
No.	Process	Condition																	
8	Handling after chip mounted  Caution	<p>(2) Example of a board cropping machine</p> <p>An outline of a printed circuit board cropping machine is shown below. The top and bottom blades are aligned with one another along the lines with the V-grooves on printed circuit board when cropping the board. Unrecommended example: Misalignment of blade position between top and bottom, right and left, or front and rear blades may cause a crack in the capacitor.</p> <div style="display: flex; justify-content: space-around;"> <div data-bbox="571 488 986 757"> <p>Outline of machine</p>  </div> <div data-bbox="1005 488 1476 929"> <p>Principle of operation</p>  <p>Cross-section diagram</p>  </div> </div> <table border="1" data-bbox="654 958 1369 1388" style="width: 100%; text-align: center;"> <thead> <tr> <th rowspan="2">Recommended</th> <th colspan="3">Unrecommended</th> </tr> <tr> <th>Top-bottom misalignment</th> <th>Left-right misalignment</th> <th>Front-rear misalignment</th> </tr> </thead> <tbody> <tr> <td>  </td> <td>  </td> <td>  </td> <td>  </td> </tr> </tbody> </table> <p>3) When functional check of the P.C.board is performed, check pin pressure tends to be adjusted higher for fear of loose contact. But if the pressure is excessive and bend the P.C.board, it may crack the chip capacitors or peel the terminations off. Please adjust the check pins not to bend the P.C.board.</p> <table border="1" data-bbox="491 1630 1449 1926" style="width: 100%;"> <thead> <tr> <th>Item</th> <th>Not recommended</th> <th>Recommended</th> </tr> </thead> <tbody> <tr> <td>Board bending</td> <td>  </td> <td>  </td> </tr> </tbody> </table>	Recommended	Unrecommended			Top-bottom misalignment	Left-right misalignment	Front-rear misalignment					Item	Not recommended	Recommended	Board bending		
Recommended	Unrecommended																		
	Top-bottom misalignment	Left-right misalignment	Front-rear misalignment																
																			
Item	Not recommended	Recommended																	
Board bending																			

No.	Process	Condition
9	Handling of loose chip capacitors	<p>1) If dropped the chip capacitors may crack. Once dropped do not use it. Especially, the large case sized chip capacitors are tendency to have cracks easily, so please handle with care.</p>  <p>2) Piling the P.C.board after mounting for storage or handling, the corner of the P.C. board may hit the chip capacitors of another board to cause crack.</p> 
10	Capacitance aging	The capacitors (Class 2) have aging in the capacitance. They may not be used in precision time constant circuit. In case of the time constant circuit, the evaluation should be done well.
11	Estimated life and estimated failure rate of capacitors	As per the estimated life and the estimated failure rate depend on the temperature and the voltage. This can be calculated by the equation described in JEITA RCR-2335C Annex F(Informative) Calculation of the estimated lifetime and the estimated failure rate (Voltage acceleration coefficient : 3 multiplication rule, Temperature acceleration coefficient : 10°C rule) The failure rate can be decreased by reducing the temperature and the voltage but they will not be guaranteed.

No.	Process	Condition
12	Caution during operation of equipment	<p>1) A capacitor shall not be touched directly with bare hands during operation in order to avoid electric shock. Electric energy held by the capacitor may be discharged through the human body when touched with a bare hand. Even when the equipment is off, a capacitor may stay charged. The capacitor should be handled after being completely discharged using a resistor.</p> <p>2) The terminals of a capacitor shall not be short-circuited by any accidental contact with a conductive object. A capacitor shall not be exposed to a conductive liquid such as an acid or alkali solution. A conductive object or liquid, such as acid and alkali, between the terminals may lead to the breakdown of a capacitor due to short circuit</p> <p>3) Confirm that the environment to which the equipment will be exposed during transportation and operation meets the specified conditions. Do not to use the equipment in the following environments.</p> <p>(1) Environment where a capacitor is splattered with water or oil (2) Environment where a capacitor is exposed to direct sunlight (3) Environment where a capacitor is exposed to Ozone, ultraviolet rays or radiation (4) Environment where a capacitor exposed to corrosive gas(e.g. hydrogen sulfide, sulfur dioxide, chlorine. ammonia gas etc.) (5) Environment where a capacitor exposed to vibration or mechanical shock exceeding the specified limits. (6) Atmosphere change with causes condensation</p>
13	<p>Others  Caution</p>	<p>The products listed on this specification sheet are intended for use in general electronic equipment (AV equipment, telecommunications equipment, home appliances, amusement equipment, computer equipment, personal equipment, office equipment, measurement equipment, industrial robots) under a normal operation and use condition.</p> <p>The products are not designed or warranted to meet the requirements of the applications listed below, whose performance and/or quality require a more stringent level of safety or reliability, or whose failure, malfunction or trouble could cause serious damage to society, person or property. Please understand that we are not responsible for any damage or liability caused by use of the products in any of the applications below or for any other use exceeding the range or conditions set forth in this specification sheet. If you intend to use the products in the applications listed below or if you have special requirements exceeding the range or conditions set forth in this specification, please contact us.</p> <p>(1) Aerospace/Aviation equipment (2) Transportation equipment (cars, electric trains, ships, etc.) (3) Medical equipment (Excepting Pharmaceutical Affairs Law classification Class1, 2) (4) Power-generation control equipment (5) Atomic energy-related equipment (6) Seabed equipment (7) Transportation control equipment (8) Public information-processing equipment (9) Military equipment (10) Electric heating apparatus, burning equipment (11) Disaster prevention/crime prevention equipment (12) Safety equipment (13) Other applications that are not considered general-purpose applications</p> <p>When designing your equipment even for general-purpose applications, you are kindly requested to take into consideration securing protection circuit/device or providing backup circuits in your equipment.</p>

13. PACKAGING LABEL

Packaging shall be done to protect the components from the damage during transportation and storing, and a label which has the following information shall be attached.

- 1) Inspection No.
- 2) TDK P/N
- 3) Customer's P/N
- 4) Quantity

*Composition of Inspection No.

Example F 7 A - 00 - 000
 (a) (b) (c) (d) (e)

- a) Line code
- b) Last digit of the year
- c) Month and A for January and B for February and so on. (Skip I)
- d) Inspection Date of the month.
- e) Serial No. of the day

14. BULK PACKAGING QUANTITY

Total number of components in a plastic bag for bulk packaging: 1,000pcs.
As for C0402, C0603 and C1005 types, not available for bulk packaging.

15. TAPE PACKAGING SPECIFICATION

1. CONSTRUCTION AND DIMENSION OF TAPING

1-1. Dimensions of carrier tape

Dimensions of paper tape shall be according to Appendix 3, 4.

Dimensions of plastic tape shall be according to Appendix 5, 6.

1-2. Bulk part and leader of taping



1-3. Dimensions of reel

Dimensions of Ø178 reel shall be according to Appendix 7, 8.

Dimensions of Ø330 reel shall be according to Appendix 9, 10.

1-4. Structure of taping



2. CHIP QUANTITY

Type	Thickness of chip	Taping Material	Chip quantity (pcs.)	
			φ178mm reel	φ330mm reel
C0402	0.20 mm	Paper	20,000	-
C0603	0.30 mm	Paper	15,000	-
C1005	0.50 mm	Paper	10,000	50,000
C1608	0.80 mm	Paper	4,000	10,000
C2012	0.60 mm	Paper	4,000	10,000
	0.85 mm	Paper or Plastic		
	1.25 mm	Plastic	2,000	
C3216	0.60 mm	Paper	4,000	10,000
	0.85 mm	Paper or Plastic		
	1.15 mm	Plastic	2,000	
	1.30 mm			
	1.60 mm			8,000
C3225	1.15 mm	Plastic	2,000	10,000
	1.25 mm		2,000	8,000
	1.30 mm			
	1.60 mm			
	2.00 mm		1,000	5,000
	2.30 mm			
	2.50 mm			
C4532	1.60 mm	Plastic	1,000	3,000
	2.00 mm			
	2.30 mm		500	
	2.50 mm			
	2.80 mm			2,000
	3.20 mm			
C5750	2.00 mm	Plastic	500	3,000
	2.30 mm			
	2.50 mm			
	2.80 mm			2,000

3. PERFORMANCE SPECIFICATIONS

3-1. Fixing peeling strength (top tape)

0.05-0.7N. (See the following figure.)



3-2. Carrier tape shall be flexible enough to be wound around a minimum radius of 30mm with components in tape.

3-3. The missing of components shall be less than 0.1%

3-4. Components shall not stick to fixing tape.

3-5. The fixing tapes shall not protrude beyond the edges of the carrier tape not shall cover the sprocket holes.

Appendix 3



Symbol Type	A	B	C	D	E	F
C0402 (C01005)	(0.25)	(0.45)	8.00 ± 0.30	3.50 ± 0.05	1.75 ± 0.10	2.00 ± 0.05
C0603 (CC0201)	(0.38)	(0.68)				
C1005 (CC0402)	(0.65) *1(0.73) *2(0.80)	(1.15) *1(1.23) *2(1.30)				
Symbol Type	G	H	J	T		
C0402 (C01005)	2.00 ± 0.05	4.00 ± 0.10	∅ 1.5 ^{+0.10} ₀	0.29 min.		
C0603 (CC0201)				0.40 min.		
C1005 (CC0402)				0.60 ± 0.05 *1 0.68 ± 0.05 *2 0.75 ± 0.05		

* The values in the parentheses () are for reference.

*1 Applied to thickness, 0.5±0.10mm and 0.50+0.15/-0.10mm products.

*2 Applied to thickness, 0.50+0.20/-0.10mm products.

Appendix 4

Paper Tape



(Unit : mm)

Symbol Type	A	B	C	D	E	F
C1608 (CC0603)	(1.10)	(1.90)	8.00 ± 0.30	3.50 ± 0.05	1.75 ± 0.10	4.00 ± 0.10
C2012 (CC0805)	(1.50)	(2.30)				
C3216 (CC1206)	(1.90)	(3.50)				
Symbol Type	G	H	J	T		
C1608 (CC0603)	2.00 ± 0.05	4.00 ± 0.10	∅ 1.5 $\begin{matrix} +0.10 \\ 0 \end{matrix}$	1.20max.		
C2012 (CC0805)						
C3216 (CC1206)						

* The values in the parentheses () are for reference.

Appendix 5

Plastic Tape

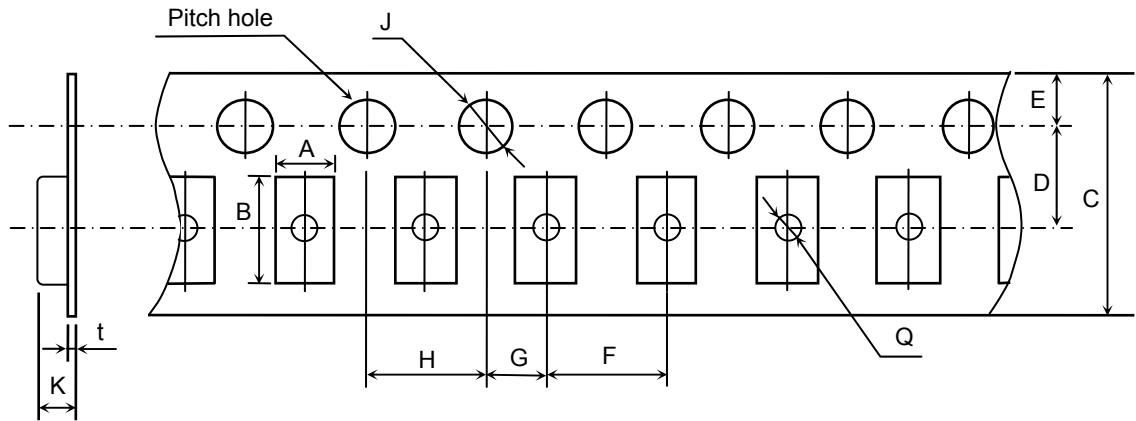

(Unit : mm)

Symbol Type	A	B	C	D	E	F
C2012 (CC0805)	(1.50)	(2.30)	8.00 ± 0.30 [12.0 ± 0.30]	3.50 ± 0.05 [5.50 ± 0.05]	1.75 ± 0.10	4.00 ± 0.10
C3216 (CC1206)	(1.90)	(3.50)				
C3225 (CC1210)	(2.90)	(3.60)				
Symbol Type	G	H	J	K	t	Q
C2012 (CC0805)	2.00 ± 0.05	4.00 ± 0.10	∅ 1.5 $\begin{matrix} +0.10 \\ 0 \end{matrix}$	3.20max.	0.60max.	∅ 0.50 min.
C3216 (CC1206)						
C3225 (CC1210)						

* The values in the parentheses () are for reference.

* As for 2.5mm thickness products, apply values in the brackets [].

* Exceptionally no hole in the cavity is applied. Please inquire if hole in cavity is mandatory.

Appendix 6

Plastic Tape



(Unit : mm)

Symbol Type	A	B	C	D	E	F
C4532 (CC1812)	(3.60)	(4.90)	12.0 ± 0.30	5.50 ± 0.05	1.75 ± 0.10	8.00 ± 0.10
C5750 (CC2220)	(5.40)	(6.10)				
Symbol Type	G	H	J	K	t	Q
C4532 (CC1812)	2.00 ± 0.05	4.00 ± 0.10	∅ 1.5 $\begin{matrix} +0.10 \\ 0 \end{matrix}$	6.50 max.	0.60 max.	∅ 1.50 min.
C5750 (CC2220)						

* The values in the parentheses () are for reference.

Appendix 7

C0402, C0603, C1005, C1608, C2012, C3216, C3225
 (As for C3225 type, any thickness of the item except 2.5mm)
 (Material : Polystyrene)



Symbol	A	B	C	D	E	W_1
Dimension	$\text{Ø}178 \pm 2.0$	$\text{Ø}60 \pm 2.0$	$\text{Ø}13 \pm 0.5$	$\text{Ø}21 \pm 0.8$	2.0 ± 0.5	9.0 ± 0.3
Symbol	W_2	r				
Dimension	13.0 ± 1.4	1.0				

Appendix 8

C3225, C4532, C5750 (As for C3225 type, applied to 2.5mm thickness products)
 (Material : Polystyrene)



Symbol	A	B	C	D	E	W_1
Dimension	$\text{Ø}178 \pm 2.0$	$\text{Ø}60 \pm 2.0$	$\text{Ø}13 \pm 0.5$	$\text{Ø}21 \pm 0.8$	2.0 ± 0.5	13.0 ± 0.3
Symbol	W_2	r				
Dimension	17.0 ± 1.4	1.0				

Appendix 9

C1005, C1608, C2012, C3216, C3225
 (As for C3225 type, any thickness of the item except 2.5mm)
 (Material : Polystyrene)

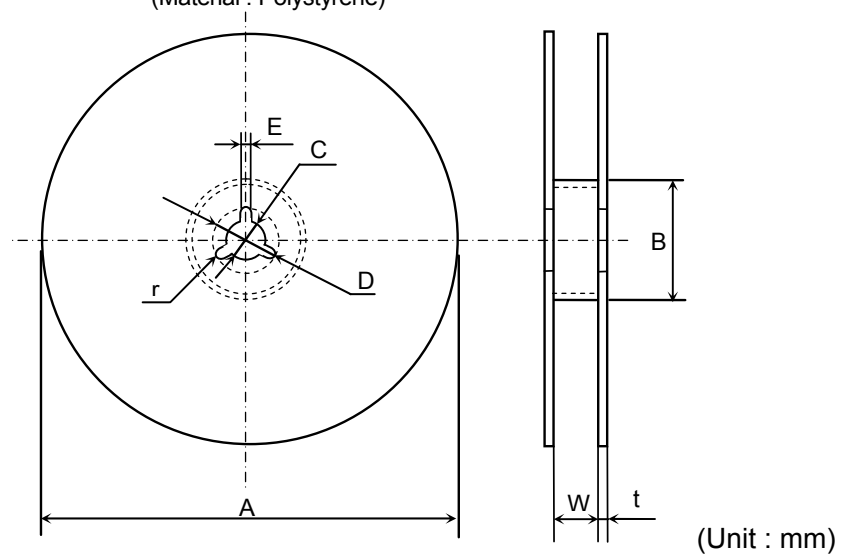

Symbol	A	B	C	D	E	W
Dimension	Ø382 max. (Nominal Ø330)	Ø50 min.	Ø13 ± 0.5	Ø21 ± 0.8	2.0 ± 0.5	10.0 ± 1.5

Symbol	t	r
Dimension	2.0 ± 0.5	1.0

Appendix 10

C3225, C4532, C5750 (As for C3225 type, applied to 2.5mm thickness products)
 (Material : Polystyrene)

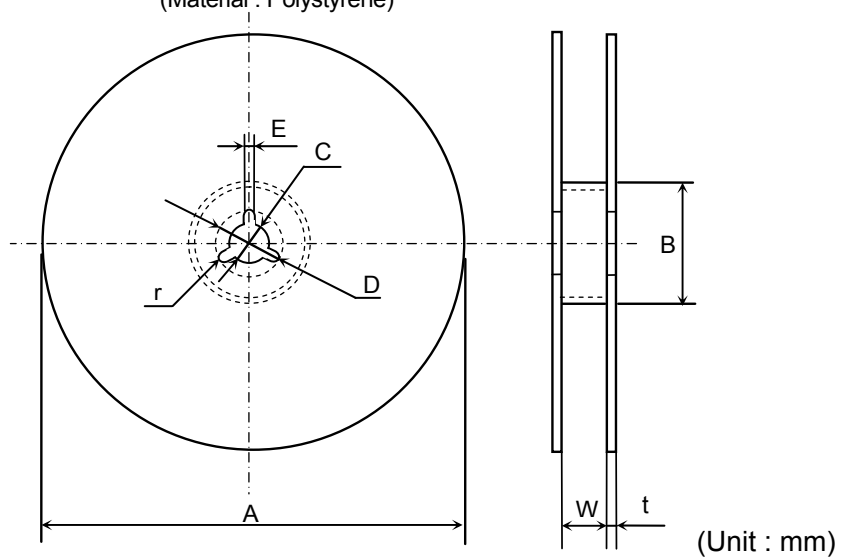

Symbol	A	B	C	D	E	W
Dimension	Ø382 max. (Nominal Ø330)	Ø50 min.	Ø13 ± 0.5	Ø21 ± 0.8	2.0 ± 0.5	14.0 ± 1.5

Symbol	t	r
Dimension	2.0 ± 0.5	1.0