



## 3-terminal Filters

For Signal Line

# YFF-SC Series

---

YFF15SC	1005 [0402 inch]*	Feed through filter
YFF18SC	1608 [0603 inch]	Feed through filter
YFF21SC	2012 [0805 inch]	Feed through filter

\* Dimensions Code JIS[EIA]

---

# 3-terminal Filters

## For Signal Line

Conformity to RoHS Directive  
Compatible with lead-free solders

# Overview of YFF-SC Series

## FEATURES

- Small and high-performance EMC components.
- Good attenuation characteristic in high frequency ranges.

## APPLICATIONS

High impedance circuits, e.g. digital signal circuits.  
I/O interface sections of devices with electric circuits and the area around connectors.  
Low-current power line of communication terminal devices, AV, and information devices.

## PART NUMBER IDENTIFICATION

YFF	21	SC	1E	473	M	T	□□	0	N					
Series name	L×W dimensions		Product internal code		Rated voltage		Capacitance		Tolerance	Taping	TDK internal code	Reel size		Internal electrode Ni
	Code	mm	Code   Signal line		Code	V	Code	pF				Code	mm	
	15	1.0×0.5	SC   Signal line		1C	16	220	22				0	ø178	
	18	1.6×0.8			1E	25	101	100				9	ø330	
	21	2.0×1.2			1H	50	221	220						
						473	47,000 (47nF)							

## OPERATING TEMPERATURE RANGE, PACKAGE QUANTITY, PRODUCT WEIGHT

Type	Package quantity (piece/reel)		Individual weight (g)
	ø178	ø330	
YFF15SC	10,000	50,000	0.0008
YFF18SC	4,000	10,000	0.0038
YFF21SC	4,000	10,000	0.0095

\* The Storage temperature range is for after the circuit board is mounted.

- Conformity to RoHS Directive: This means that, in conformity with EU Directive 2011/65/EC, lead, cadmium, mercury, hexavalent chromium, and specific bromine-based flame retardants, PBB and PBDE, have not been used, except for exempted applications.
- Please contact our Sales office when your application is considered the following:  
The device's failure or malfunction may directly endanger human life (e.g. application for automobile/aircraft/medical/nuclear power devices, etc.)

 Please be sure to request delivery specifications that provide further details on the features and specifications of the products for proper and safe use. Please note that the contents may change without any prior notice due to reasons such as upgrading.

# Overview of YFF-SC Series

## RECOMMENDED SOLDERING CONDITION

### REFLOW SOLDERING

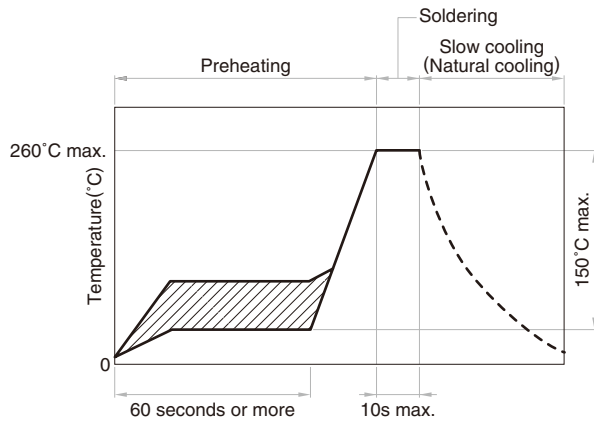

### HAND SOLDERING

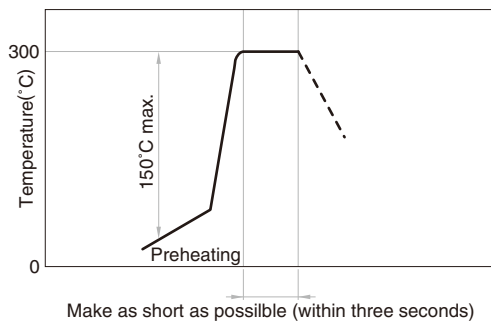

## PRECAUTIONS FOR USE

- Before soldering, be sure to preheat components. The  $\Delta T$  preheating temperature must be 150°C max. with attention paid to thermal shock.
- Natural cooling of components in the air is recommended. On the other hand, when dipping them in a solvent for purposes, such as cleaning, make sure that the temperature difference ( $\Delta T$ ) is 100°
- When performing hand soldering for circuit modification, apply the soldering iron to the copper foil area of the printed circuit board for 3 seconds or less. The temperature of the iron tip should not exceed 300°C.
- Use a wrist band to discharge static electricity in your body through the grounding wire.
- When incorporating the printed circuit board on which this product is mounted into a frame, etc., do not apply stress to the product through local bending of the board by tightening of screws, etc.

# YFF-SC Series YFF15SC Type (Feed Through Filter)

## SHAPES AND DIMENSIONS

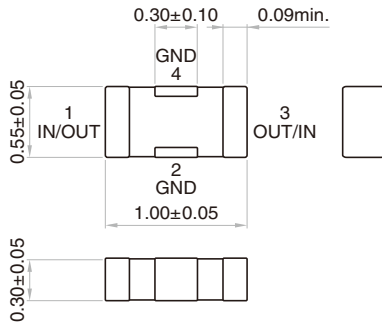

## RECOMMENDED LAND PATTERN

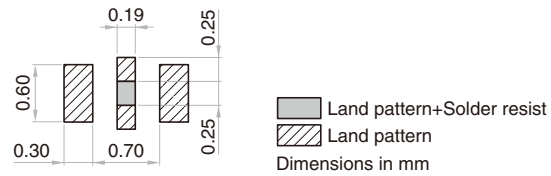

\* Make sure to connect the GND terminal of this product and the GND of the mounting circuit board by using through holes so that the distance between them is the shortest.

## ELECTRICAL CHARACTERISTICS

### CHARACTERISTICS SPECIFICATION TABLE

Cutoff frequency (MHz)	Insertion loss 30dB bandwidth (MHz)	Rated voltage Edc (V)	Rated current Idc (A)	Operating temperature range (°C)	Storage temperature range(After mount) (°C)	Part No.*
0.1	5 to 4000	16	1	-55 to 125	-55 to 125	YFF15SC1C473MT00 □ N
0.3	10 to 4000	16	1	-55 to 125	-55 to 125	YFF15SC1C223MT00 □ N
0.6	20 to 4000	25	1	-55 to 125	-55 to 125	YFF15SC1E103MT00 □ N
1	50 to 4000	25	1	-55 to 125	-55 to 125	YFF15SC1E472MT00 □ N
3	100 to 4000	25	1	-55 to 125	-55 to 125	YFF15SC1E222MT00 □ N
6	200 to 4000	25	1	-55 to 125	-55 to 125	YFF15SC1E102MT00 □ N
10	600 to 4000	25	1	-55 to 125	-55 to 125	YFF15SC1E471MT00 □ N
30	800 to 6000	50	1	-55 to 125	-55 to 125	YFF15SC1H221MT00 □ N
60	1500 to 6000	50	1	-55 to 125	-55 to 125	YFF15SC1H101MT00 □ N
100	2000 to 6000	50	1	-55 to 125	-55 to 125	YFF15SC1H470MT00 □ N
300	4000 to 6000	50	1	-55 to 125	-55 to 125	YFF15SC1H220MT00 □ N

\* The part numbers are TDK's standard specification products.

\* □: Please specify reel size code, 0 (ø178) or 9 (ø330)

## ELECTRICAL CHARACTERISTICS GRAPH (EXAMPLE)

### INSERTION LOSS vs. FREQUENCY CHARACTERISTICS

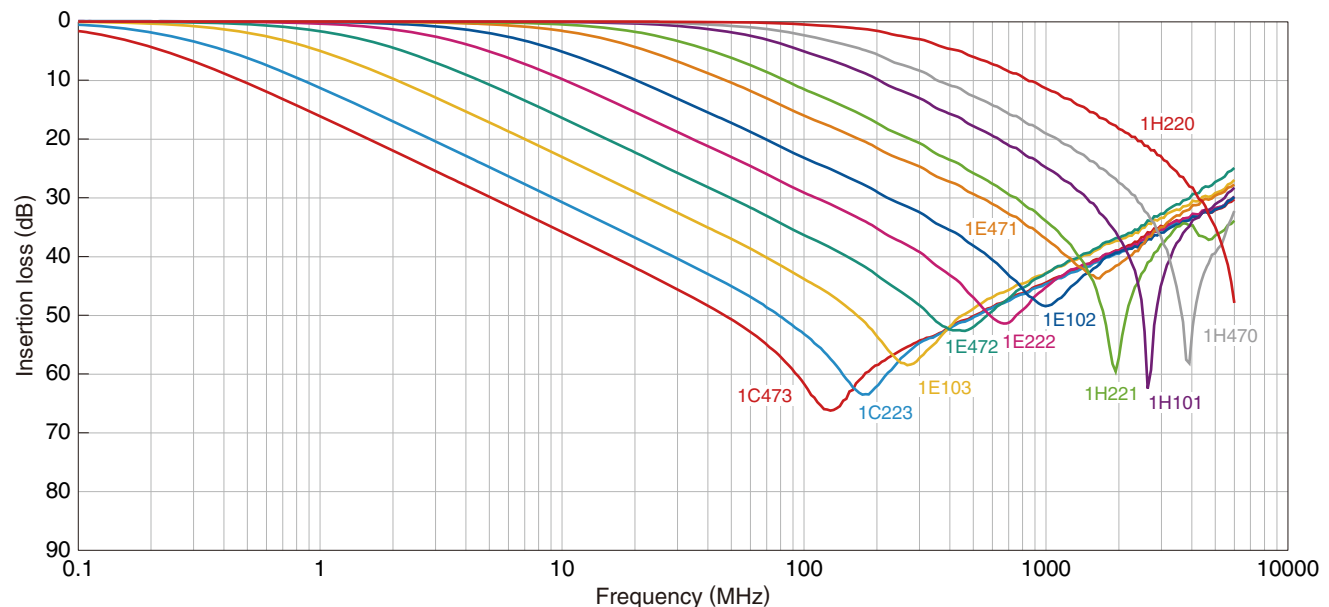

⚠ Please be sure to request delivery specifications that provide further details on the features and specifications of the products for proper and safe use. Please note that the contents may change without any prior notice due to reasons such as upgrading.

# YFF-SC Series YFF18SC Type (Feed Through Filter)

## SHAPES AND DIMENSIONS

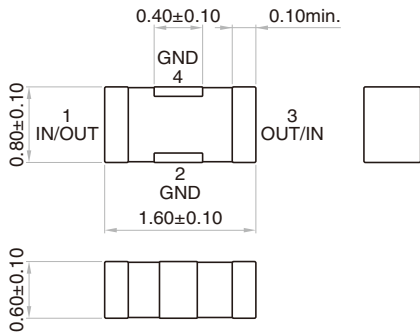

## RECOMMENDED LAND PATTERN

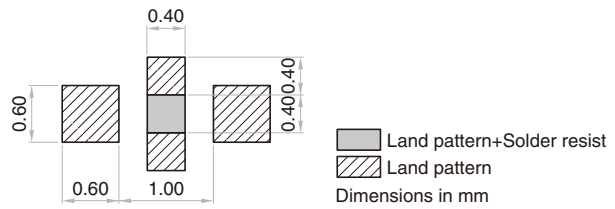

\* Make sure to connect the GND terminal of this product and the GND of the mounting circuit board by using through holes so that the distance between them is the shortest.

## ELECTRICAL CHARACTERISTICS

### CHARACTERISTICS SPECIFICATION TABLE

Cutoff frequency (MHz)	Insertion loss 30dB bandwidth (MHz)	Rated voltage Edc (V)	Rated current Idc (A)	Operating temperature range (°C)	Storage temperature range(After mount) (°C)	Part No.*
0.3	10 to 3000	50	1	-55 to 125	-55 to 125	YFF18SC1H223MT0H <input type="checkbox"/> N
0.6	20 to 3000	50	1	-55 to 125	-55 to 125	YFF18SC1H103MT0H <input type="checkbox"/> N
1	40 to 3000	50	1	-55 to 125	-55 to 125	YFF18SC1H472MT0H <input type="checkbox"/> N
2	90 to 3000	50	1	-55 to 125	-55 to 125	YFF18SC1H222MT0H <input type="checkbox"/> N
6	200 to 3000	50	1	-55 to 125	-55 to 125	YFF18SC1H102MT0H <input type="checkbox"/> N
10	400 to 6000	50	1	-55 to 125	-55 to 125	YFF18SC1H471MT0H <input type="checkbox"/> N
20	800 to 6000	50	1	-55 to 125	-55 to 125	YFF18SC1H221MT0H <input type="checkbox"/> N
60	1500 to 6000	50	1	-55 to 125	-55 to 125	YFF18SC1H101MT0H <input type="checkbox"/> N
100	2000 to 6000	50	1	-55 to 125	-55 to 125	YFF18SC1H470MT0H <input type="checkbox"/> N
200	4000 to 6000	50	1	-55 to 125	-55 to 125	YFF18SC1H220MT0H <input type="checkbox"/> N

\* The part numbers are TDK's standard specification products.

\* : Please specify reel size code, 0 (ø178) or 9 (ø330)

## ELECTRICAL CHARACTERISTICS GRAPH (EXAMPLE)

### INSERTION LOSS vs. FREQUENCY CHARACTERISTICS

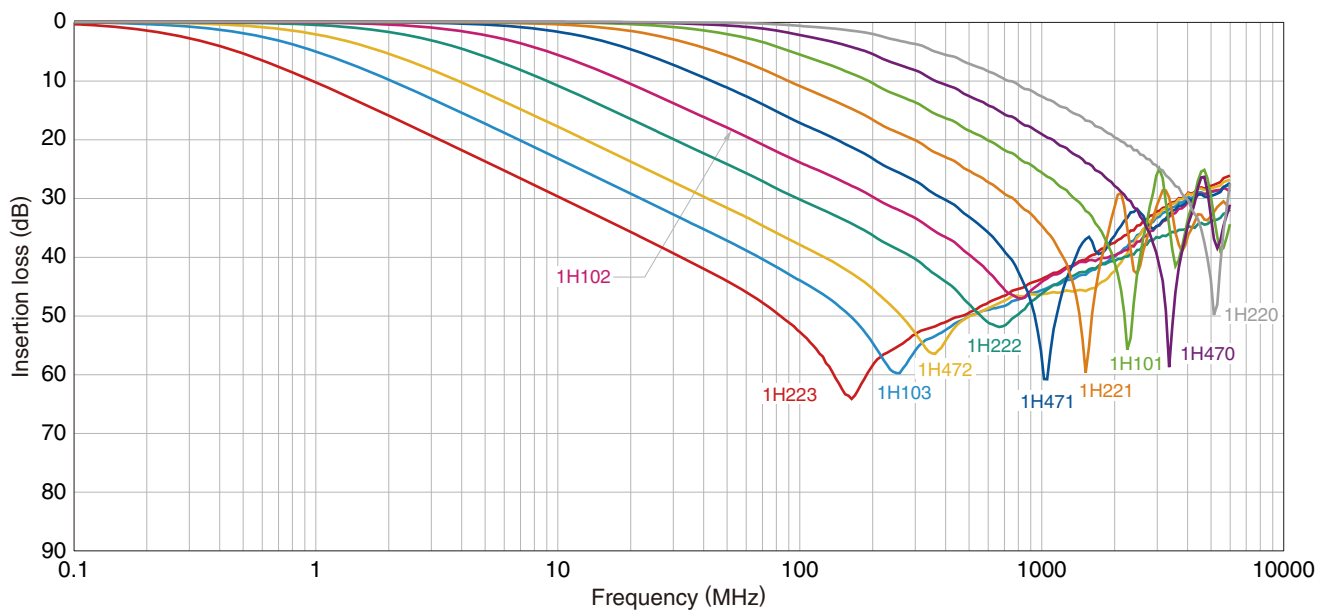

 Please be sure to request delivery specifications that provide further details on the features and specifications of the products for proper and safe use. Please note that the contents may change without any prior notice due to reasons such as upgrading.

# YFF-SC Series YFF21SC Type (Feed Through Filter)

## SHAPES AND DIMENSIONS

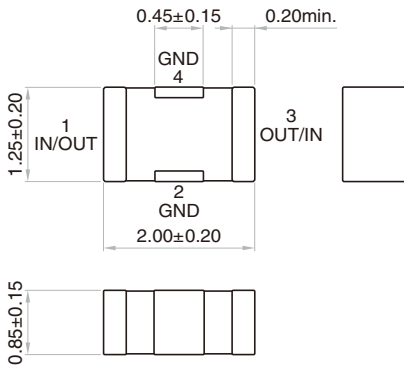

## RECOMMENDED LAND PATTERN

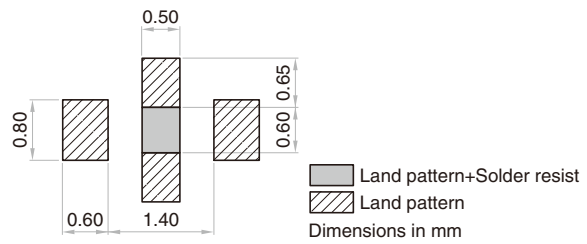

\* Make sure to connect the GND terminal of this product and the GND of the mounting circuit board by using through holes so that the distance between them is the shortest.

## ELECTRICAL CHARACTERISTICS

### CHARACTERISTICS SPECIFICATION TABLE

Cutoff frequency (MHz)	Insertion loss 30dB bandwidth (MHz)	Rated voltage Edc (V)	Rated current Idc (A)	Operating temperature range (°C)	Storage temperature range(After mount) (°C)	Part No.*
0.1	5 to 2000	50	2	-55 to 125	-55 to 125	YFF21SC1H473MT00 <input type="checkbox"/> N
0.1	5 to 2000	25	2	-55 to 125	-55 to 125	YFF21SC1E473MT00 <input type="checkbox"/> N
0.2	10 to 2000	50	2	-55 to 125	-55 to 125	YFF21SC1H223MT00 <input type="checkbox"/> N
0.2	10 to 2000	25	2	-55 to 125	-55 to 125	YFF21SC1E223MT00 <input type="checkbox"/> N
0.5	20 to 2000	25	1	-55 to 125	-55 to 125	YFF21SC1E103MT00 <input type="checkbox"/> N
1	40 to 2000	50	0.4	-55 to 125	-55 to 125	YFF21SC1H472MT00 <input type="checkbox"/> N
2	70 to 2000	50	0.4	-55 to 125	-55 to 125	YFF21SC1H222MT00 <input type="checkbox"/> N
5	200 to 2000	50	0.4	-55 to 125	-55 to 125	YFF21SC1H102MT00 <input type="checkbox"/> N
10	400 to 5000	50	0.4	-55 to 125	-55 to 125	YFF21SC1H471MT00 <input type="checkbox"/> N
20	700 to 5000	50	0.4	-55 to 125	-55 to 125	YFF21SC1H221MT00 <input type="checkbox"/> N
50	1000 to 5000	50	0.4	-55 to 125	-55 to 125	YFF21SC1H101MT00 <input type="checkbox"/> N
100	2000 to 5000	50	0.4	-55 to 125	-55 to 125	YFF21SC1H470MT00 <input type="checkbox"/> N
200	3000 to 5000	50	0.4	-55 to 125	-55 to 125	YFF21SC1H220MT00 <input type="checkbox"/> N

\* The part numbers are TDK's standard specification products.

\* : Please specify reel size code, 0 (ø178) or 9 (ø330)

## ELECTRICAL CHARACTERISTICS GRAPH

### INSERTION LOSS vs. FREQUENCY CHARACTERISTICS

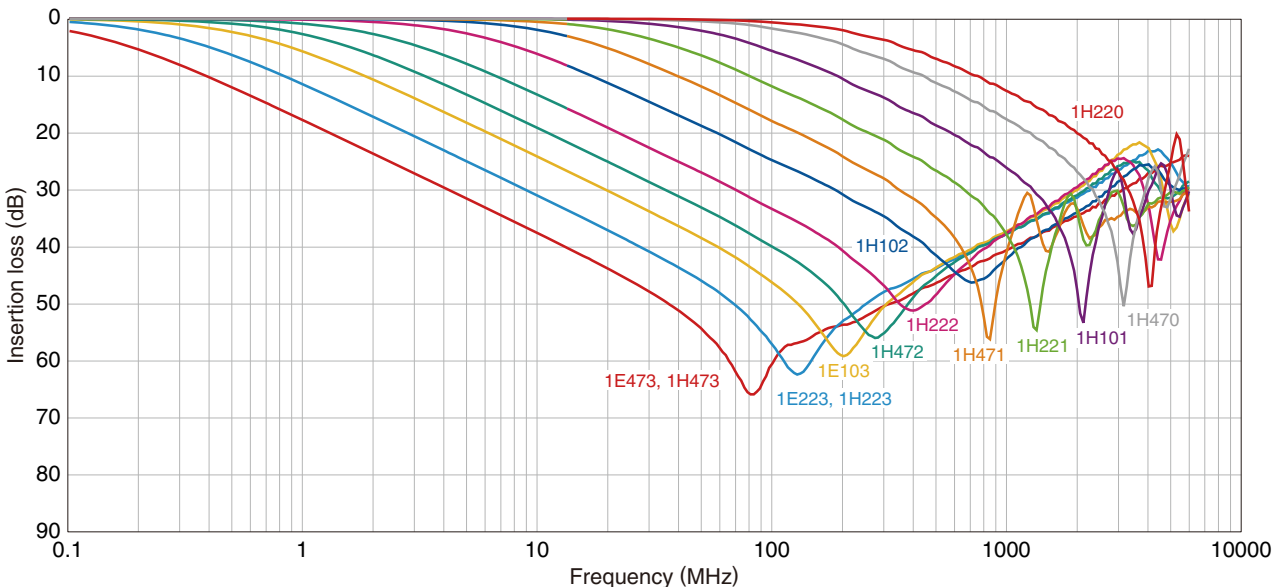

**!** Please be sure to request delivery specifications that provide further details on the features and specifications of the products for proper and safe use. Please note that the contents may change without any prior notice due to reasons such as upgrading.

# YFF-SC Series Packing Style

## REEL DIMENSIONS

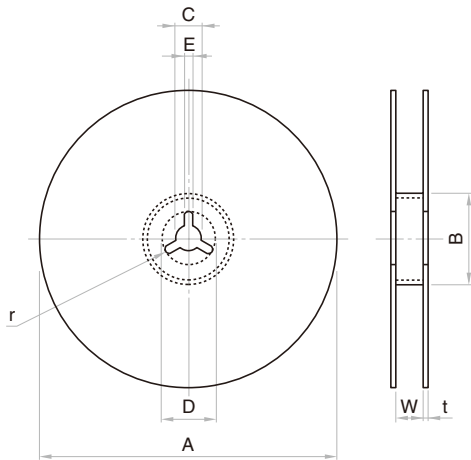

Dimensions in mm

Reel	A	B	C	D	E	W	t	r
ø178	ø178±2.0	ø60±2.0	ø13±0.5	ø21±0.8	2.0±0.5	9.0±0.3	2.0±0.5	1.0
ø330	ø382 max.(ø330 nom.)	ø50 min.	ø13±0.5	ø21±0.8	2.0±0.5	10.0±1.5	2.0±0.5	1.0

## TAPE DIMENSIONS

### Paper tape

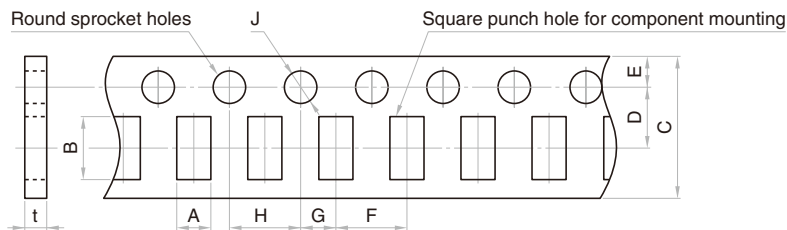

Dimensions in mm

Type	A	B	C	D	E	F	G	H	J	t
YFF15SC	0.62 typ.	1.12 typ.	8.0±0.3	3.5±0.05	1.75±0.1	2.0±0.05	2.0±0.05	4.0±0.1	ø1.5+0.1/-0	0.7 max.
YFF18SC	1.10 typ.	1.90 typ.	8.0±0.3	3.5±0.05	1.75±0.1	4.0±0.1	2.0±0.05	4.0±0.1	ø1.5+0.1/-0	1.1 max.
YFF21SC	1.50 typ.	2.3 typ.	8.0±0.3	3.5±0.05	1.75±0.1	4.0±0.1	2.0±0.05	4.0±0.1	ø1.5+0.1/-0	1.1 max.

 Please be sure to request delivery specifications that provide further details on the features and specifications of the products for proper and safe use. Please note that the contents may change without any prior notice due to reasons such as upgrading.