



Chip beads

For general signal line

MMZ series

MMZ1005_{Type}

MMZ1005

1005[0402 inch]*

* Dimensions code JIS[EIA]

Reminders for using these products

Before using these products, be sure to request the delivery specifications.

Safety reminders

Please pay sufficient attention to the warnings for safe designing when using this products.

Reminders

- The storage period is less than 12 months. Be sure to follow the storage conditions (temperature: 5 to 40°C, humidity: 10 to 75% RH or less).
If the storage period elapses, the soldering of the terminal electrodes may deteriorate.
- Do not use or store in locations where there are conditions such as gas corrosion (salt, acid, alkali, etc.).
- Before soldering, be sure to preheat components.
The preheating temperature should be set so that the temperature difference between the solder temperature and chip temperature does not exceed 150°C.
- Soldering corrections after mounting should be within the range of the conditions determined in the specifications.
If overheated, a short circuit, performance deterioration, or lifespan shortening may occur.
- When embedding a printed circuit board where a chip is mounted to a set, be sure that residual stress is not given to the chip due to the overall distortion of the printed circuit board and partial distortion such as at screw tightening portions.
- Self heating (temperature increase) occurs when the power is turned ON, so the tolerance should be sufficient for the set thermal design.
- Carefully lay out the coil for the circuit board design of the non-magnetic shield type.
A malfunction may occur due to magnetic interference.
- Use a wrist band to discharge static electricity in your body through the grounding wire.
- Do not expose the products to magnets or magnetic fields.
- Do not use for a purpose outside of the contents regulated in the delivery specifications.
- The products listed on this catalog are intended for use in general electronic equipment (AV equipment, telecommunications equipment, home appliances, amusement equipment, computer equipment, personal equipment, office equipment, measurement equipment, industrial robots) under a normal operation and use condition.
The products are not designed or warranted to meet the requirements of the applications listed below, whose performance and/or quality require a more stringent level of safety or reliability, or whose failure, malfunction or trouble could cause serious damage to society, person or property.
If you intend to use the products in the applications listed below or if you have special requirements exceeding the range or conditions set forth in the each catalog, please contact us.

- (1) Aerospace/aviation equipment
- (2) Transportation equipment (cars, electric trains, ships, etc.)
- (3) Medical equipment
- (4) Power-generation control equipment
- (5) Atomic energy-related equipment
- (6) Seabed equipment
- (7) Transportation control equipment

- (8) Public information-processing equipment
- (9) Military equipment
- (10) Electric heating apparatus, burning equipment
- (11) Disaster prevention/crime prevention equipment
- (12) Safety equipment
- (13) Other applications that are not considered general-purpose applications

When designing your equipment even for general-purpose applications, you are kindly requested to take into consideration securing protection circuit/device or providing backup circuits in your equipment.

Chip beads

For general signal line

Product compatible with RoHS directive
Halogen-free

Overview of MMZ1005 type

FEATURES

- Noise reduction solution for general signal line.
- Various frequency characteristics with 5 materials of different features for countermeasures against everything from general signals to high-speed signals.

APPLICATION

- Noise removal for mobile devices such as smartphones and tablet terminals, and various modules.
- Noise removal for PCs and recorders, household appliances such as STBs, smart grids, and industrial equipment.

PART NUMBER CONSTRUCTION

| Series name | LxWxT dimensions (mm) | | Material name | Impedance (Ω) at 100MHz | | Characteristic type | Packaging style | | Internal code |
|-------------|-----------------------|-------------|---------------|----------------------------------|-----|---------------------|-----------------|--------|---------------|
| MMZ | 1005 | 1.0x0.5x0.5 | B | 800 | 80 | C | T | Taping | 000 |
| | | | D | 121 | 120 | | | | |
| | | | F | | | | | | |
| | | | S | | | | | | |
| | | | Y | | | | | | |

OPERATING TEMPERATURE RANGE, PACKAGE QUANTITY, PRODUCT WEIGHT

| Type | Temperature ranges | | Package quantity (pieces/reel) | Individual weight (mg) |
|---------|-------------------------------|------------------------------|-----------------------------------|---------------------------|
| | Operating temperature (°C) | Storage temperature* (°C) | | |
| MMZ1005 | -55 to +125 | -55 to +125 | 10,000 | 1 |

* The storage temperature range is for after the circuit board is mounted.

- RoHS Directive Compliant Product: See the following for more details.<https://product.tdk.com/info/en/environment/rohs/index.html>
- Halogen-free: indicates that Cl content is less than 900ppm, Br content is less than 900ppm, and that the total Cl and Br content is less than 1500ppm.

 Please be sure to request delivery specifications that provide further details on the features and specifications of the products for proper and safe use.
Please note that the contents may change without any prior notice due to reasons such as upgrading.

MMZ1005 type

RECOMMENDED REFLOW PROFILE



| Preheating | | | Soldering | | Peak | |
|------------|-------|------------|-----------|-----------|--------------|------|
| Temp. | Temp. | Time | Temp. | Time | Temp. | Time |
| T1 | T2 | t1 | T3 | t2 | T4 | t3 |
| 150°C | 180°C | 60 to 120s | 230°C | 30 to 60s | 250 to 260°C | 10s |

MMZ1005 type

■ MATERIAL CHARACTERISTIC

- B material:** This type is perfectly suited for fast digital signals. By equalizing R components and X components that beads possess at a frequency of 5MHz, it is able to suppress overshooting, undershooting and ringing of fast digital signals.
- S material:** Standard type that features impedance characteristics similar to those of a typical ferrite core. For signal line applications in which the blocking region is near 100MHz. Impedance values selected for effectiveness at 40 to 300MHz.
- Y material:** High frequency range type intended for the 100MHz region and above. For signal line applications in which the signal frequency is far from the cutoff frequency. Impedance values selected for effectiveness at 80 to 400MHz.
- D material:** For applications calling for low insertion loss at low frequencies and sharply increasing impedance at high frequencies. Designed for high impedance at high frequencies (00MHz to 1GHz) for signal line applications.
- F material:** This new product inherits the characteristic of our D-material, namely its sharp impedance rise time, and its impedance peak frequency has been shifted higher into range. The product offers excellent noise suppression from 600MHz to as high as in the GHz range.

■ TYPICAL MATERIAL IMPEDANCE CHARACTERISTICS



MMZ1005 type

SHAPE & DIMENSIONS

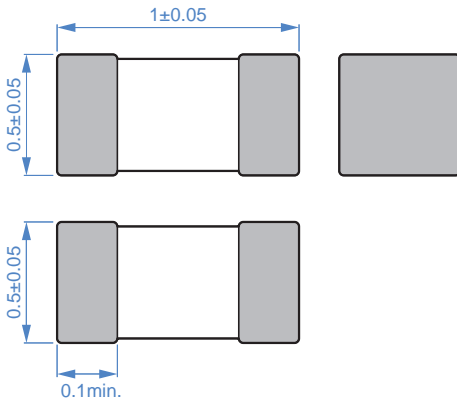

Dimensions in mm

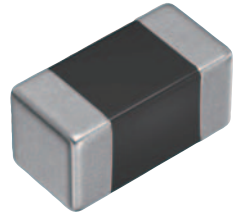

RECOMMENDED LAND PATTERN

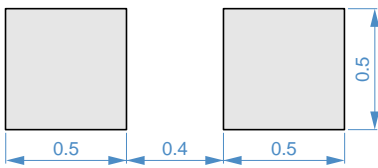

Dimensions in mm

Please be sure to request delivery specifications that provide further details on the features and specifications of the products for proper and safe use. Please note that the contents may change without any prior notice due to reasons such as upgrading.

MMZ1005 type

ELECTRICAL CHARACTERISTICS

CHARACTERISTICS SPECIFICATION TABLE

| Impedance [100MHz] (Ω) | | DC resistance (Ω)max. | Rated current (mA)max. | Part No. |
|---------------------------------------|------------|-----------------------------------|---------------------------|------------------|
| | Tolerance | | | |
| 80 | $\pm 25\%$ | 0.19 | 450 | MMZ1005B800CT000 |
| 120 | $\pm 25\%$ | 0.25 | 400 | MMZ1005B121CT000 |
| 600 | $\pm 25\%$ | 0.85 | 200 | MMZ1005B601CT000 |
| 80 | $\pm 25\%$ | 0.12 | 500 | MMZ1005S800CT000 |
| 120 | $\pm 25\%$ | 0.22 | 500 | MMZ1005S121CT000 |
| 240 | $\pm 25\%$ | 0.28 | 400 | MMZ1005S241CT000 |
| 600 | $\pm 25\%$ | 0.52 | 300 | MMZ1005S601CT000 |
| 1000 | $\pm 25\%$ | 0.75 | 200 | MMZ1005S102CT000 |
| 40 | $\pm 25\%$ | 0.10 | 550 | MMZ1005Y400CT000 |
| 80 | $\pm 25\%$ | 0.17 | 450 | MMZ1005Y800CT000 |
| 120 | $\pm 25\%$ | 0.18 | 400 | MMZ1005Y121CT000 |
| 240 | $\pm 25\%$ | 0.26 | 300 | MMZ1005Y241CT000 |
| 300 | $\pm 25\%$ | 0.38 | 250 | MMZ1005Y301CT000 |
| 470 | $\pm 25\%$ | 0.47 | 250 | MMZ1005Y471CT000 |
| 600 | $\pm 25\%$ | 0.54 | 250 | MMZ1005Y601CT000 |
| 1000 | $\pm 25\%$ | 0.70 | 200 | MMZ1005Y102CT000 |
| 1500 | $\pm 25\%$ | 1.00 | 100 | MMZ1005Y152CT000 |
| 1800 | $\pm 25\%$ | 0.85 | 150 | MMZ1005Y182CT000 |
| 10 | $\pm 5\%$ | 0.10 | 500 | MMZ1005D100CT000 |
| 22 | $\pm 25\%$ | 0.17 | 400 | MMZ1005D220CT000 |
| 33 | $\pm 25\%$ | 0.24 | 400 | MMZ1005D330CT000 |
| 68 | $\pm 25\%$ | 0.38 | 400 | MMZ1005D680CT000 |
| 120 | $\pm 25\%$ | 0.60 | 350 | MMZ1005D121CT000 |
| 240 | $\pm 25\%$ | 0.90 | 200 | MMZ1005D241CT000 |
| 33 | $\pm 25\%$ | 0.50 | 200 | MMZ1005F330CT000 |
| 47 | $\pm 25\%$ | 0.60 | 100 | MMZ1005F470CT000 |
| 56 | $\pm 25\%$ | 0.70 | 100 | MMZ1005F560CT000 |

○ Measurement equipment

| Measurement item | Product No. | Manufacturer |
|------------------|---------------|-----------------------|
| Impedance | E4991A+16192A | Keysight Technologies |
| DC resistance | Type-7556 | Yokogawa |

* Equivalent measurement equipment may be used.

MMZ1005 type

ELECTRICAL CHARACTERISTICS

Z VS. FREQUENCY CHARACTERISTICS (BY SERIES)

MMZ1005B series



MMZ1005S series



MMZ1005Y series



MMZ1005D series

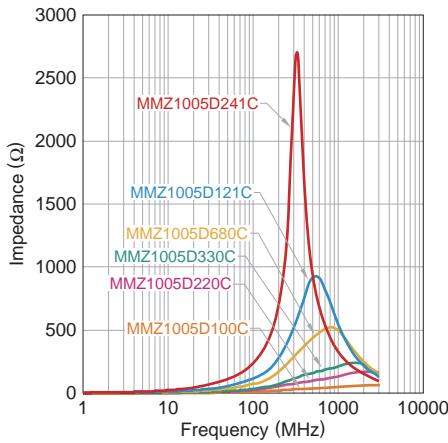

MMZ1005F series

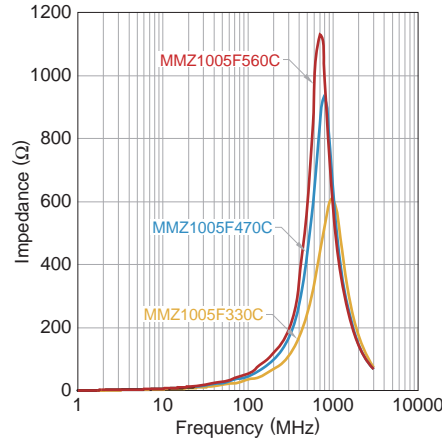

 Please be sure to request delivery specifications that provide further details on the features and specifications of the products for proper and safe use. Please note that the contents may change without any prior notice due to reasons such as upgrading.

MMZ1005 type

ELECTRICAL CHARACTERISTICS

Z, X, R VS. FREQUENCY CHARACTERISTICS

MMZ1005B800CT000

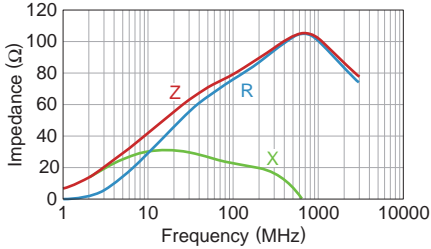

MMZ1005B121CT000

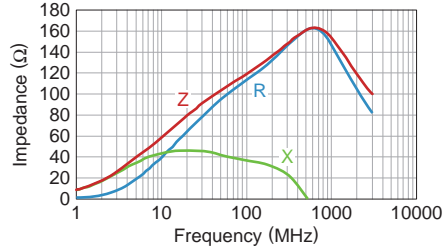

MMZ1005B601CT000

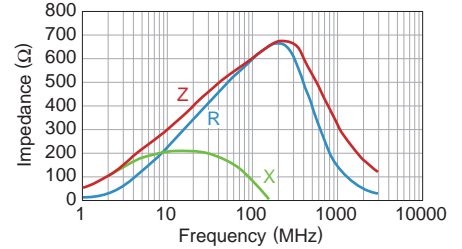

MMZ1005S800CT000

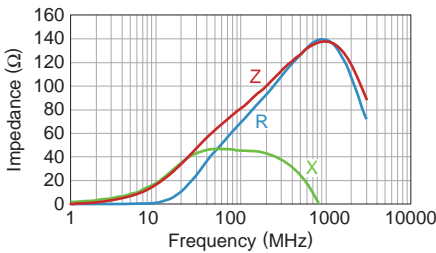

MMZ1005S121CT000

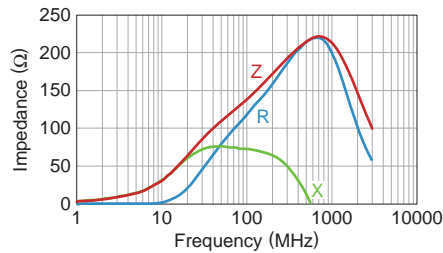

MMZ1005S241CT000

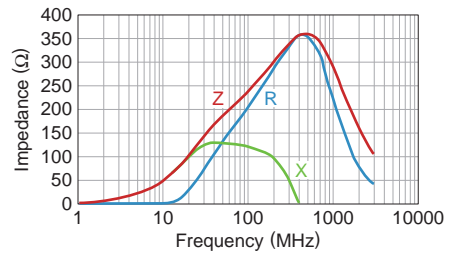

MMZ1005S601CT000

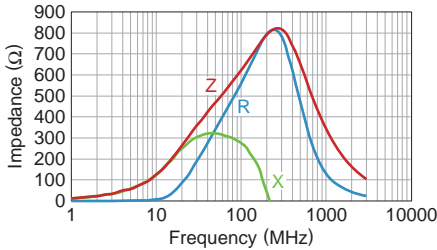

MMZ1005S102CT000

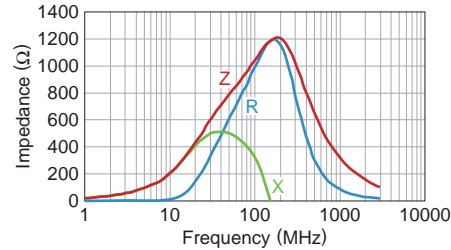

MMZ1005Y400CT000

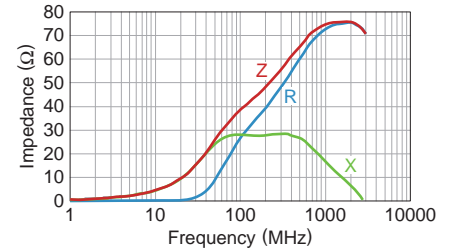

MMZ1005Y800CT000

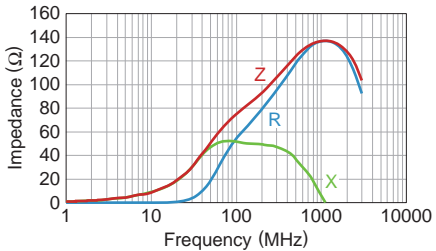

MMZ1005Y121CT000

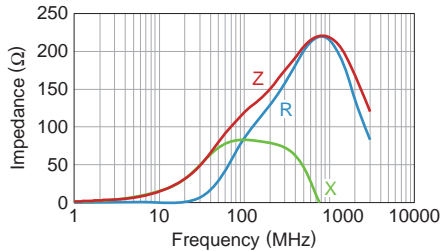

MMZ1005Y241CT000

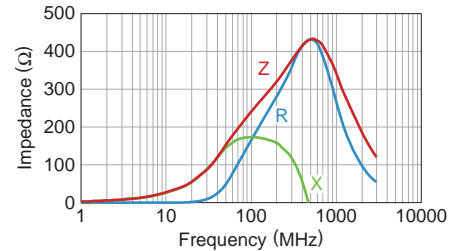

MMZ1005Y301CT000

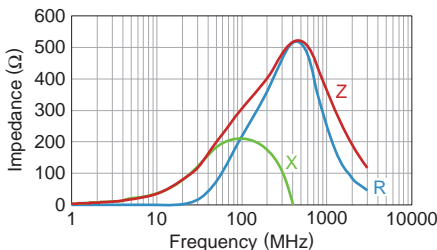

MMZ1005Y471CT000

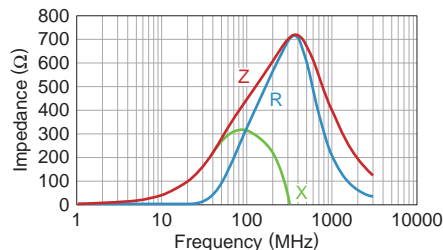

MMZ1005Y601CT000

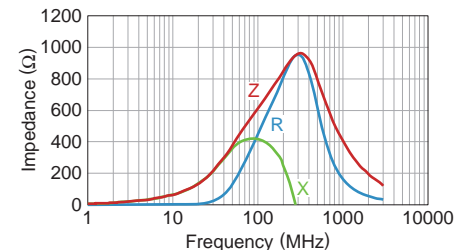

 Please be sure to request delivery specifications that provide further details on the features and specifications of the products for proper and safe use. Please note that the contents may change without any prior notice due to reasons such as upgrading.

MMZ1005 type

ELECTRICAL CHARACTERISTICS

Z, X, R VS. FREQUENCY CHARACTERISTICS

MMZ1005Y102CT000

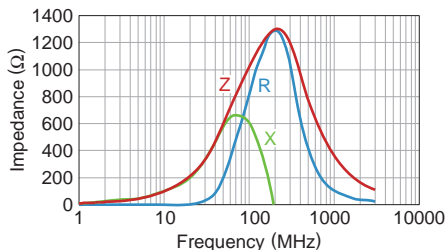

MMZ1005Y152CT000

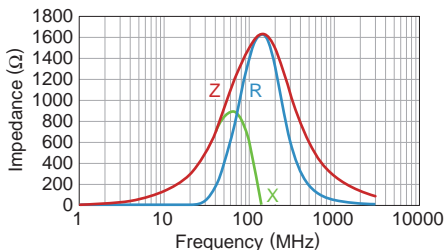

MMZ1005Y182CT000

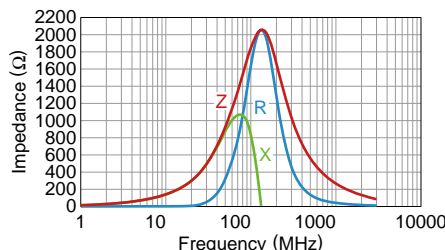

MMZ1005D100CT000

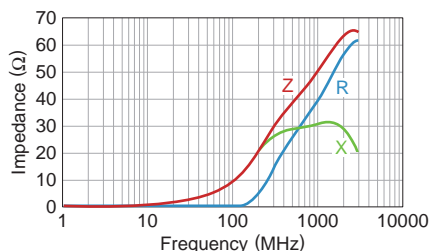

MMZ1005D220CT000

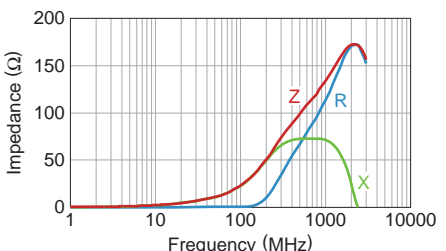

MMZ1005D330CT000

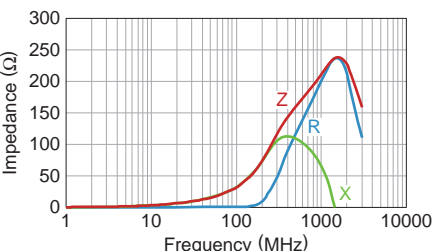

MMZ1005D680CT000

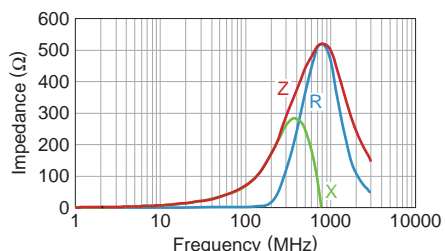

MMZ1005D121CT000

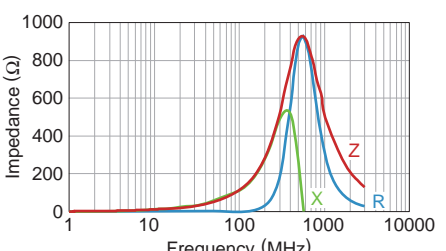

MMZ1005D241CT000

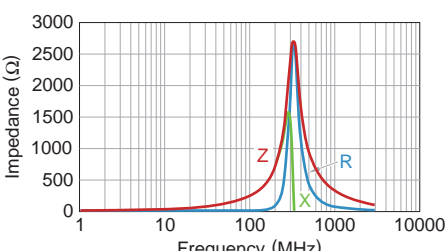

MMZ1005F330CT000

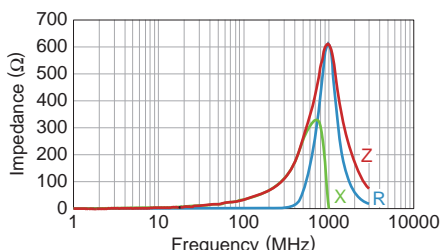

MMZ1005F470CT000

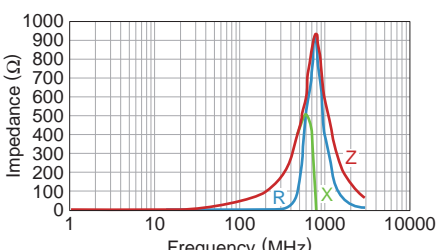

MMZ1005F560CT000

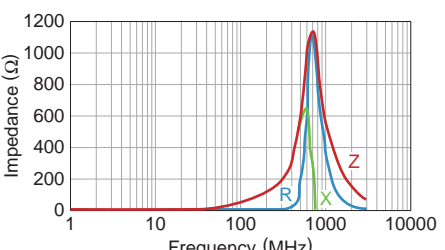

 Please be sure to request delivery specifications that provide further details on the features and specifications of the products for proper and safe use. Please note that the contents may change without any prior notice due to reasons such as upgrading.

MMZ1005 type

PACKAGING STYLE

REEL DIMENSIONS

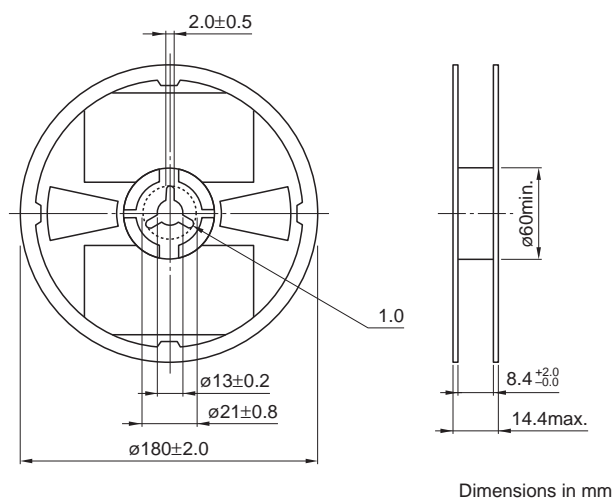

TAPE DIMENSIONS

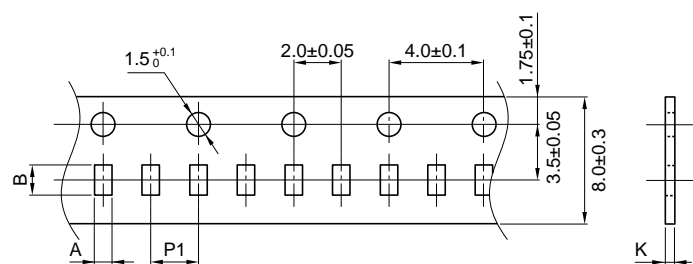

| Type | A | B | P1 | K |
|----------------|----------------|----------------|----------------|---------|
| MMZ1005 | 0.65 ± 0.1 | 1.15 ± 0.1 | 2.0 ± 0.05 | 0.8max. |

