



Chip beads

For general signal line

MMZ series

MMZ1608_{Type}

MMZ1608

1608[0603 inch]*

* Dimensions code JIS[EIA]

Reminders for using these products

Before using these products, be sure to request the delivery specifications.

Safety reminders

Please pay sufficient attention to the warnings for safe designing when using this products.

Reminders

- The storage period is less than 12 months. Be sure to follow the storage conditions (temperature: 5 to 40°C, humidity: 10 to 75% RH or less).
If the storage period elapses, the soldering of the terminal electrodes may deteriorate.
- Do not use or store in locations where there are conditions such as gas corrosion (salt, acid, alkali, etc.).
- Before soldering, be sure to preheat components.
The preheating temperature should be set so that the temperature difference between the solder temperature and chip temperature does not exceed 150°C.
- Soldering corrections after mounting should be within the range of the conditions determined in the specifications.
If overheated, a short circuit, performance deterioration, or lifespan shortening may occur.
- When embedding a printed circuit board where a chip is mounted to a set, be sure that residual stress is not given to the chip due to the overall distortion of the printed circuit board and partial distortion such as at screw tightening portions.
- Self heating (temperature increase) occurs when the power is turned ON, so the tolerance should be sufficient for the set thermal design.
- Carefully lay out the coil for the circuit board design of the non-magnetic shield type.
A malfunction may occur due to magnetic interference.
- Use a wrist band to discharge static electricity in your body through the grounding wire.
- Do not expose the products to magnets or magnetic fields.
- Do not use for a purpose outside of the contents regulated in the delivery specifications.
- The products listed on this catalog are intended for use in general electronic equipment (AV equipment, telecommunications equipment, home appliances, amusement equipment, computer equipment, personal equipment, office equipment, measurement equipment, industrial robots) under a normal operation and use condition.
The products are not designed or warranted to meet the requirements of the applications listed below, whose performance and/or quality require a more stringent level of safety or reliability, or whose failure, malfunction or trouble could cause serious damage to society, person or property.
If you intend to use the products in the applications listed below or if you have special requirements exceeding the range or conditions set forth in the each catalog, please contact us.

- (1) Aerospace/aviation equipment
- (2) Transportation equipment (cars, electric trains, ships, etc.)
- (3) Medical equipment
- (4) Power-generation control equipment
- (5) Atomic energy-related equipment
- (6) Seabed equipment
- (7) Transportation control equipment

- (8) Public information-processing equipment
- (9) Military equipment
- (10) Electric heating apparatus, burning equipment
- (11) Disaster prevention/crime prevention equipment
- (12) Safety equipment
- (13) Other applications that are not considered general-purpose applications

When designing your equipment even for general-purpose applications, you are kindly requested to take into consideration securing protection circuit/device or providing backup circuits in your equipment.

Chip beads

For general signal line

Product compatible with RoHS directive
Halogen-free
Compatible with lead-free solders

Overview of MMZ1608 type

FEATURES

- Noise reduction solution for general signal line.
- Various frequency characteristics with 8 materials of different features for countermeasures against everything from general signals to high-speed signals.

APPLICATION

- Noise removal for mobile devices such as smartphones and tablet terminals, and various modules.
- Noise removal for PCs and recorders, household appliances such as STBs, smart grids, and industrial equipment.

PART NUMBER CONSTRUCTION

MMZ	1608	S	121	A	T	A00	
Series name	LxWxT dimensions (mm)		Impedance (Ω) at 100MHz		Characteristic type	Packaging style	Internal code
	1608	1.6x0.8x0.6 1.6x0.8x0.8	121	120	C A B	T Taping	A00 AH0
		A B D F Q R S Y					

OPERATING TEMPERATURE RANGE, PACKAGE QUANTITY, PRODUCT WEIGHT

Type	Temperature ranges		Package quantity (pieces/reel)	Individual weight (mg)
	Operating temperature (°C)	Storage temperature* (°C)		
MMZ1608	t=0.6mm	-55 to +125	4,000	3
	t=0.8mm	-55 to +125	4,000	4

* The storage temperature range is for after the circuit board is mounted.

- RoHS Directive Compliant Product: See the following for more details. <https://product.tdk.com/info/en/environment/rohs/index.html>
- Halogen-free: indicates that Cl content is less than 900ppm, Br content is less than 900ppm, and that the total Cl and Br content is less than 1500ppm.

 Please be sure to request delivery specifications that provide further details on the features and specifications of the products for proper and safe use.
Please note that the contents may change without any prior notice due to reasons such as upgrading.

MMZ1608 type

RECOMMENDED REFLOW PROFILE

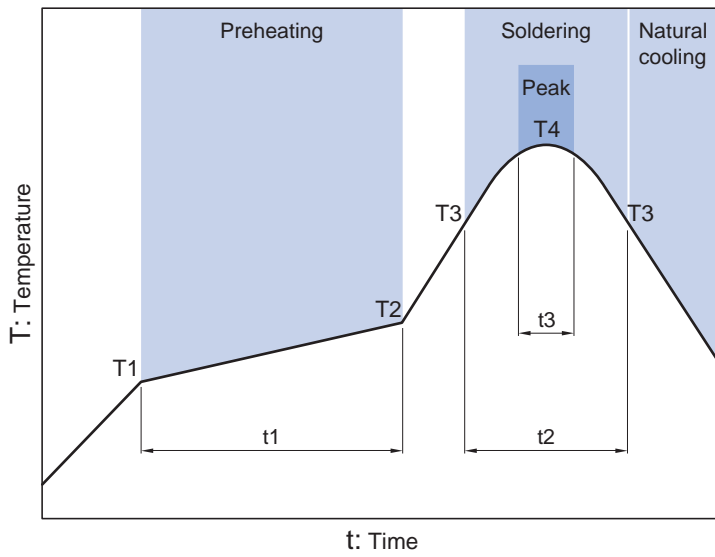

Preheating			Soldering		Peak	
Temp.	Temp.	Time	Temp.	Time	Temp.	Time
T1	T2	t1	T3	t2	T4	t3
150°C	180°C	60 to 120s	230°C	30 to 60s	250 to 260°C	10s

MMZ1608 type

MATERIAL CHARACTERISTIC

- B material:** This type is perfectly suited for fast digital signals. By equalizing R components and X components that beads possess at a frequency of 5MHz, it is able to suppress overshooting, undershooting and ringing of fast digital signals.
- R material:** For wide frequency applications calling for broad impedance characteristics. For digital signal line applications calling requiring good waveform integrity. Impedance values selected for effectiveness at 10 to 200MHz.
- S material:** Standard type that features impedance characteristics similar to those of a typical ferrite core. For signal line applications in which the blocking region is near 100MHz. Impedance values selected for effectiveness at 40 to 300MHz.
- Y material:** High frequency range type intended for the 100MHz region and above. For signal line applications in which the signal frequency is far from the cutoff frequency. Impedance values selected for effectiveness at 80 to 400MHz.
- A material:** This high-impedance product is based on the impedance frequency characteristics of our Y-material. The product offers excellent impedance characteristics, which is greater than 2500Ω , in the vicinity of 100MHz range (MMZ1608A252B).
- Q material:** High frequency range type intended for the 100MHz region and above. Impedance values selected for effectiveness at 100 to 800MHz.
- D material:** For applications calling for low insertion loss at low frequencies and sharply increasing impedance at high frequencies. Designed for high impedance at high frequencies (300MHz to 1GHz) for signal line applications.
- F material:** This new product inherits the characteristic of our D-material, namely its sharp impedance rise time, and its impedance peak frequency has been shifted higher into range. The product offers excellent noise suppression from 600MHz to as high as in the GHz range.

TYPICAL MATERIAL IMPEDANCE CHARACTERISTICS

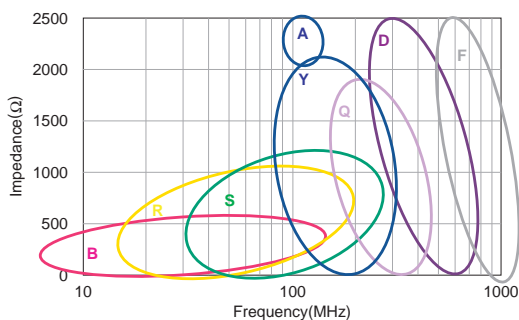

MMZ1608 type

SHAPE & DIMENSIONS

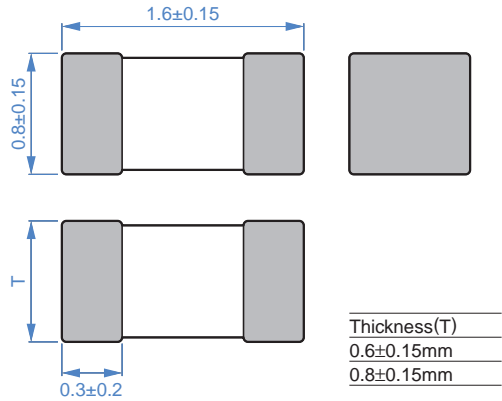

Dimensions in mm

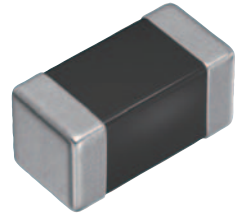

RECOMMENDED LAND PATTERN

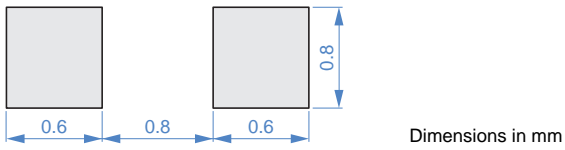

Dimensions in mm

 Please be sure to request delivery specifications that provide further details on the features and specifications of the products for proper and safe use. Please note that the contents may change without any prior notice due to reasons such as upgrading.

MMZ1608 type

ELECTRICAL CHARACTERISTICS

CHARACTERISTICS SPECIFICATION TABLE

Impedance [100MHz] (Ω)		DC resistance (Ω)max.	Rated current (mA)max.	Thickness T (mm)	Part No.
Tolerance					
120	$\pm 25\%$	0.15	600	0.6	MMZ1608B121CTAH0
220	$\pm 25\%$	0.25	500	0.6	MMZ1608B221CTAH0
300	$\pm 25\%$	0.25	500	0.6	MMZ1608B301CTAH0
470	$\pm 25\%$	0.30	500	0.6	MMZ1608B471CTAH0
600	$\pm 25\%$	0.40	500	0.6	MMZ1608B601CTAH0
1000	$\pm 25\%$	0.60	300	0.8	MMZ1608B102CTA00
15	$\pm 25\%$	0.05	1500	0.8	MMZ1608R150ATA00
30	$\pm 25\%$	0.05	1500	0.8	MMZ1608R300ATA00
60	$\pm 25\%$	0.10	800	0.8	MMZ1608R600ATA00
120	$\pm 25\%$	0.18	500	0.8	MMZ1608R121ATA00
300	$\pm 25\%$	0.25	500	0.8	MMZ1608R301ATA00
470	$\pm 25\%$	0.30	500	0.8	MMZ1608R471ATA00
600	$\pm 25\%$	0.40	500	0.8	MMZ1608R601ATA00
1000	$\pm 25\%$	0.50	400	0.8	MMZ1608R102ATA00
40	$\pm 25\%$	0.10	600	0.8	MMZ1608S400ATA00
80	$\pm 25\%$	0.15	500	0.8	MMZ1608S800ATA00
120	$\pm 25\%$	0.15	500	0.8	MMZ1608S121ATA00
180	$\pm 25\%$	0.20	500	0.8	MMZ1608S181ATA00
220	$\pm 25\%$	0.20	500	0.8	MMZ1608S221ATA00
300	$\pm 25\%$	0.30	500	0.8	MMZ1608S301ATA00
470	$\pm 25\%$	0.30	500	0.8	MMZ1608S471ATA00
600	$\pm 25\%$	0.35	500	0.8	MMZ1608S601ATA00
1000	$\pm 25\%$	0.50	400	0.8	MMZ1608S102ATA00
2000	$\pm 25\%$	0.90	200	0.8	MMZ1608S202ATA00
15	$\pm 25\%$	0.05	1500	0.8	MMZ1608Y150BTA00
30	$\pm 25\%$	0.05	1500	0.8	MMZ1608Y300BTA00
60	$\pm 25\%$	0.15	500	0.8	MMZ1608Y600BTA00
120	$\pm 25\%$	0.20	500	0.8	MMZ1608Y121BTA00
220	$\pm 25\%$	0.30	500	0.8	MMZ1608Y221BTA00
300	$\pm 25\%$	0.30	500	0.8	MMZ1608Y301BTA00
470	$\pm 25\%$	0.35	500	0.8	MMZ1608Y471BTA00
600	$\pm 25\%$	0.40	500	0.8	MMZ1608Y601BTA00
750	$\pm 25\%$	0.45	500	0.8	MMZ1608Y751BTA00
1000	$\pm 25\%$	0.50	400	0.8	MMZ1608Y102BTA00
1500	$\pm 25\%$	0.60	300	0.8	MMZ1608Y152BTA00
1800	$\pm 25\%$	0.80	200	0.8	MMZ1608A182BTA00
2200	$\pm 25\%$	0.80	200	0.8	MMZ1608A222BTA00
2500	$\pm 25\%$	0.80	200	0.8	MMZ1608A252BTA00
120	$\pm 25\%$	0.30	500	0.8	MMZ1608Q121BTA00
220	$\pm 25\%$	0.40	500	0.8	MMZ1608Q221BTA00
330	$\pm 25\%$	0.50	400	0.8	MMZ1608Q331BTA00
470	$\pm 25\%$	0.70	300	0.8	MMZ1608Q471BTA00
600	$\pm 25\%$	0.80	200	0.8	MMZ1608Q601BTA00
1000	$\pm 25\%$	1.00	200	0.8	MMZ1608Q102BTA00

○ Measurement equipment

Measurement item	Product No.	Manufacturer
Impedance	E4991A+16192A	Keysight Technologies
DC resistance	Type-7556	Yokogawa

* Equivalent measurement equipment may be used.

MMZ1608 type

ELECTRICAL CHARACTERISTICS

CHARACTERISTICS SPECIFICATION TABLE

Impedance [100MHz] (Ω)		DC resistance (Ω)max.	Rated current (mA)max.	Thickness T (mm)	Part No.
	Tolerance				
5	$\pm 2\Omega$	0.05	700	0.8	MMZ1608D050CTA00
10	$\pm 5\Omega$	0.10	500	0.6	MMZ1608D100CTAH0
22	$\pm 25\%$	0.20	500	0.6	MMZ1608D220CTAH0
50	$\pm 25\%$	0.25	500	0.6	MMZ1608D500CTAH0
80	$\pm 25\%$	0.30	500	0.6	MMZ1608D800CTAH0
80	$\pm 25\%$	0.30	500	0.8	MMZ1608D800BTA00
120	$\pm 25\%$	0.30	400	0.6	MMZ1608D121CTAH0
120	$\pm 25\%$	0.30	400	0.8	MMZ1608D121BTA00
240	$\pm 25\%$	0.60	300	0.8	MMZ1608D241CTA00
300	$\pm 25\%$	0.70	300	0.8	MMZ1608D301BTA00
3typ.		0.05	700	0.8	MMZ1608F030BTA00
47	$\pm 25\%$	0.40	500	0.8	MMZ1608F470BTA00
75	$\pm 25\%$	0.55	300	0.8	MMZ1608F750BTA00
120	$\pm 25\%$	0.75	200	0.8	MMZ1608F121BTA00

Measurement equipment

Measurement item	Product No.	Manufacturer
Impedance	E4991A+16192A	Keysight Technologies
DC resistance	Type-7556	Yokogawa

* Equivalent measurement equipment may be used.

MMZ1608 type

ELECTRICAL CHARACTERISTICS

Z VS. FREQUENCY CHARACTERISTICS (BY SERIES)

MMZ1608B series

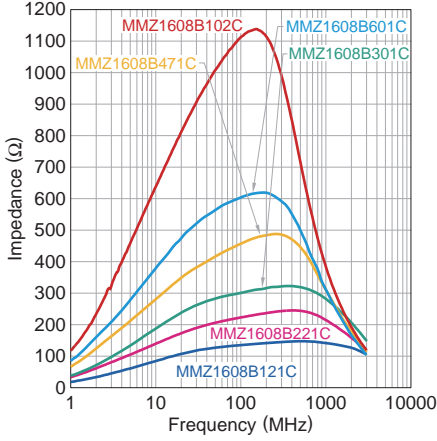

MMZ1608R series

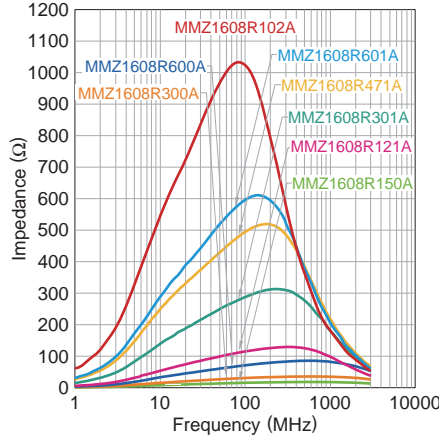

MMZ1608S series

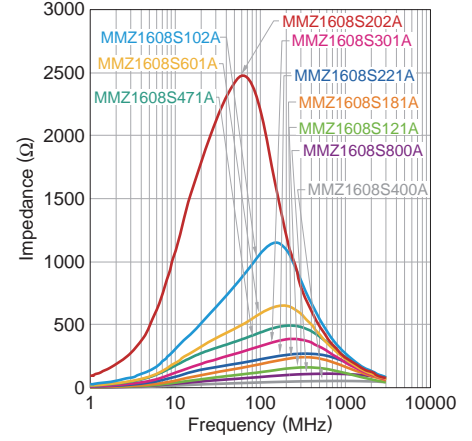

MMZ1608Y series

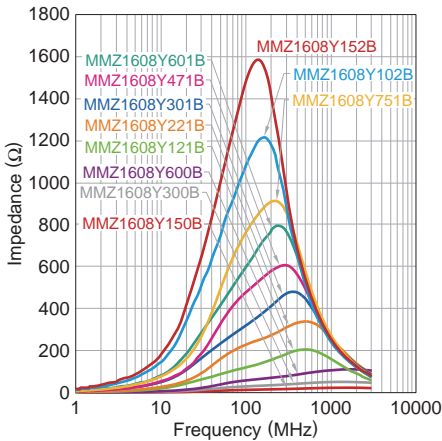

MMZ1608A series

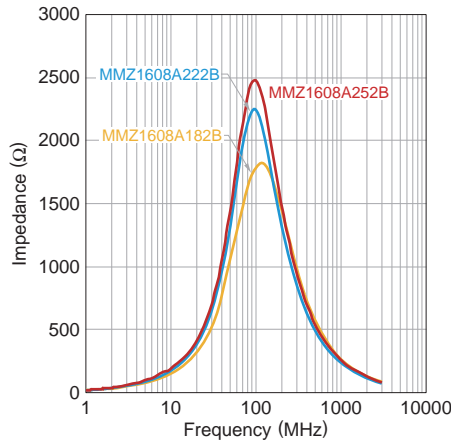

MMZ1608Q series

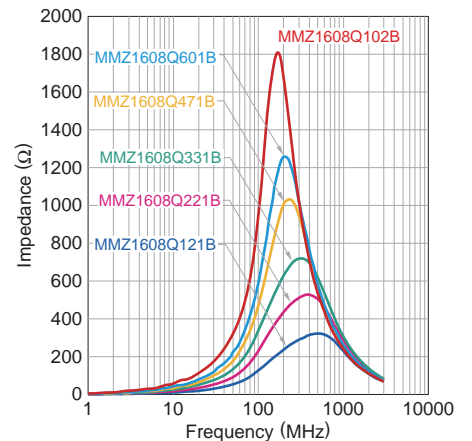

MMZ1608D series

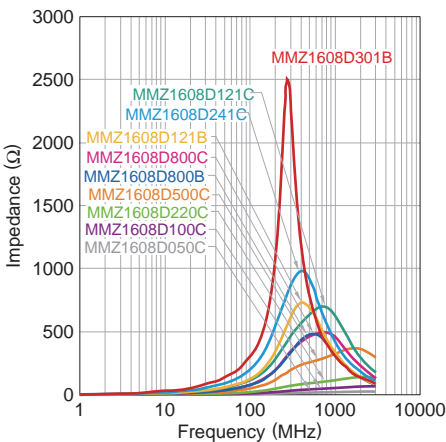

MMZ1608F series

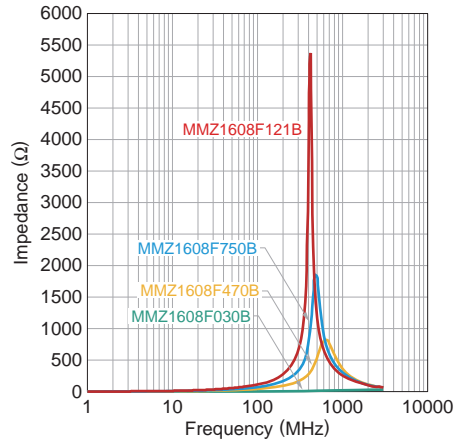

⚠ Please be sure to request delivery specifications that provide further details on the features and specifications of the products for proper and safe use.
Please note that the contents may change without any prior notice due to reasons such as upgrading.

MMZ1608 type

ELECTRICAL CHARACTERISTICS

Z, X, R VS. FREQUENCY CHARACTERISTICS

MMZ1608B121CTAH0

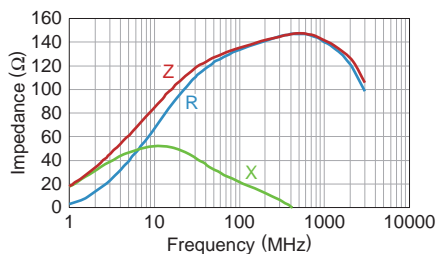

MMZ1608B221CTAH0

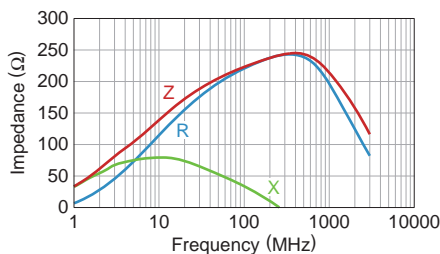

MMZ1608B301CTAH0

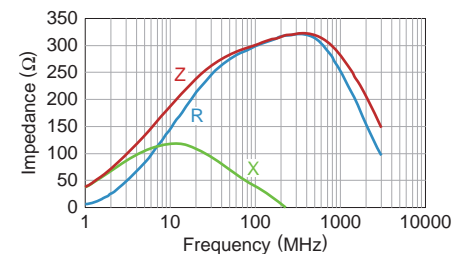

MMZ1608B471CTAH0

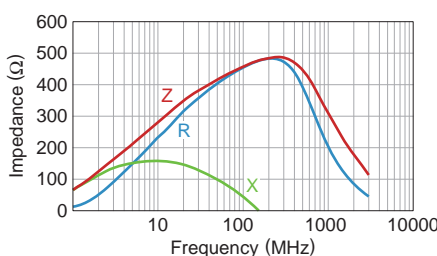

MMZ1608B601CTAH0

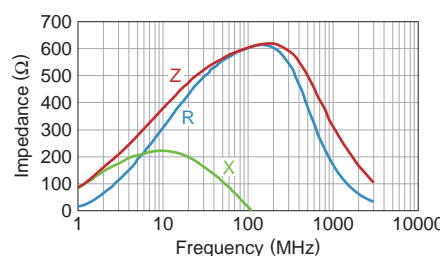

MMZ1608B102CTA00

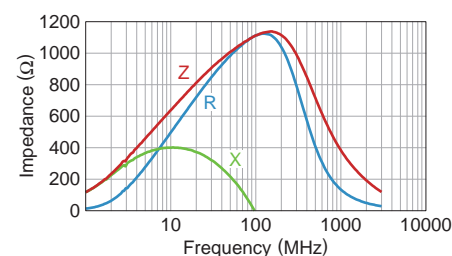

MMZ1608R150ATA00

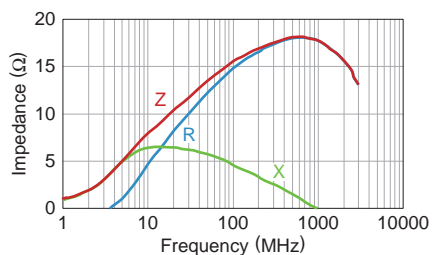

MMZ1608R300ATA00

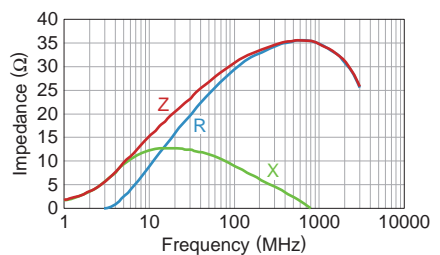

MMZ1608R600ATA00

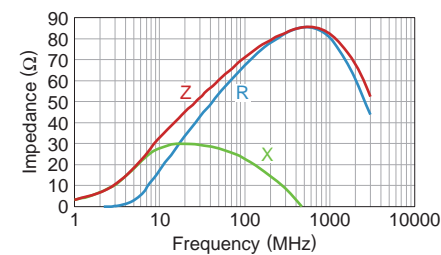

MMZ1608R121ATA00

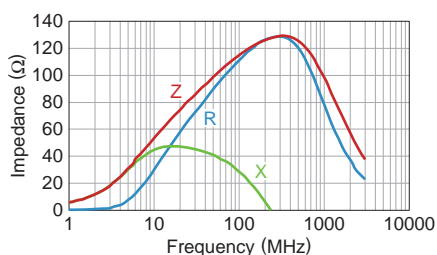

MMZ1608R301ATA00

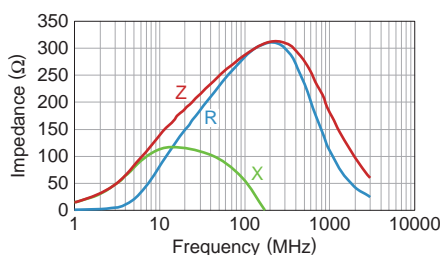

MMZ1608R471ATA00

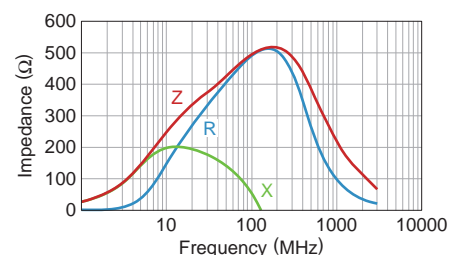

MMZ1608R601ATA00

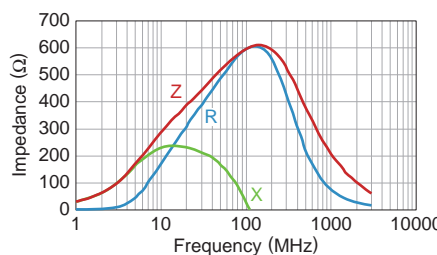

MMZ1608R102ATA00

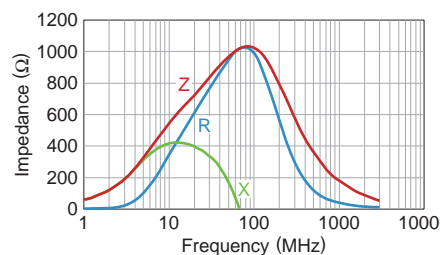

MMZ1608S400ATA00

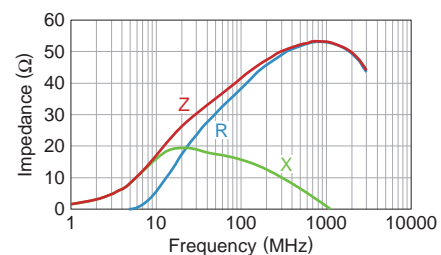

⚠ Please be sure to request delivery specifications that provide further details on the features and specifications of the products for proper and safe use. Please note that the contents may change without any prior notice due to reasons such as upgrading.

MMZ1608 type

ELECTRICAL CHARACTERISTICS

Z, X, R VS. FREQUENCY CHARACTERISTICS

MMZ1608S800ATA00

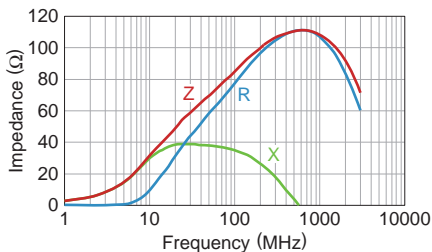

MMZ1608S121ATA00

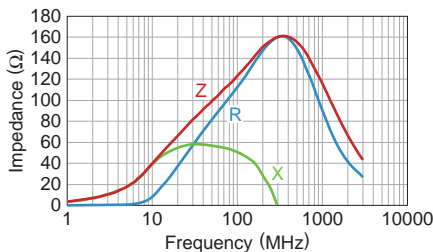

MMZ1608S181ATA00

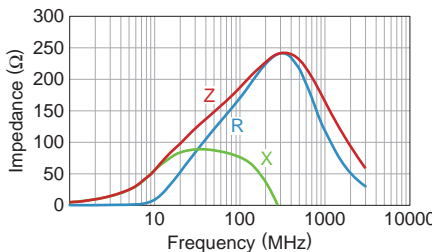

MMZ1608S221ATA00

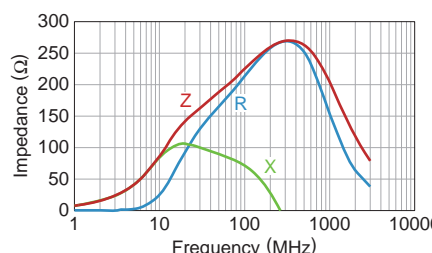

MMZ1608S301ATA00

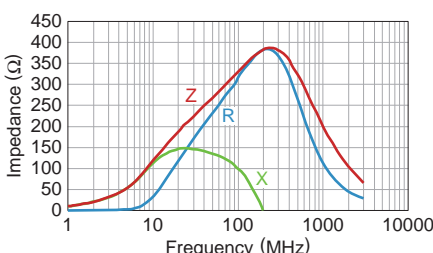

MMZ1608S471ATA00

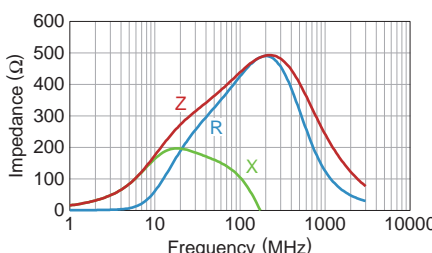

MMZ1608S601ATA00

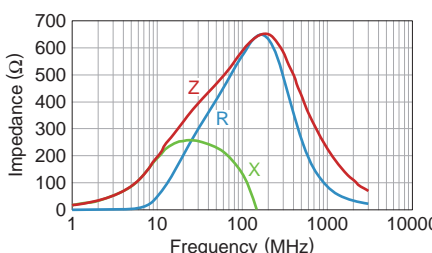

MMZ1608S102ATA00

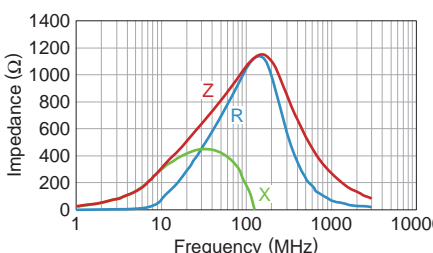

MMZ1608S202ATA00

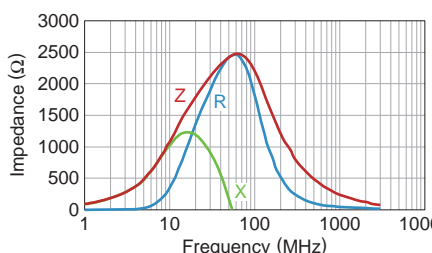

MMZ1608Y150BTA00

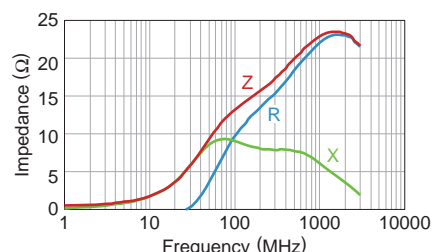

MMZ1608Y300BTA00

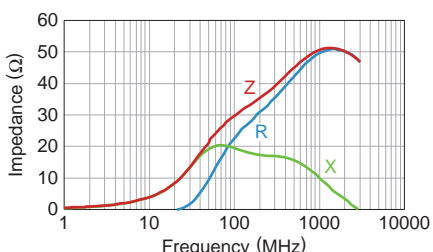

MMZ1608Y600BTA00

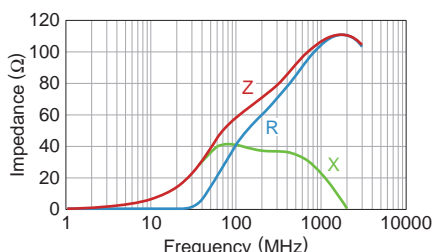

MMZ1608Y121BTA00

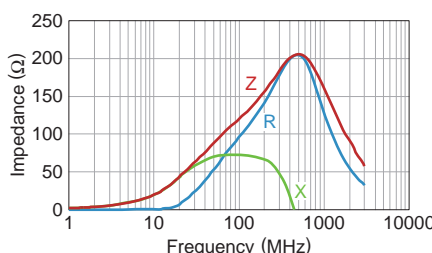

MMZ1608Y221BTA00

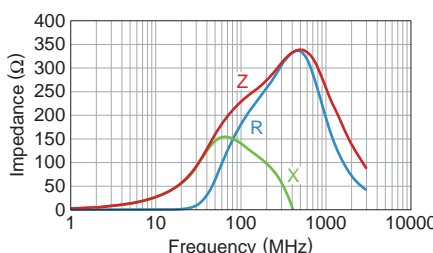

MMZ1608Y301BTA00

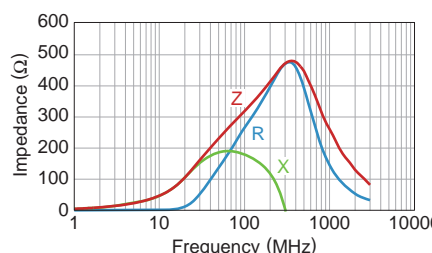

⚠ Please be sure to request delivery specifications that provide further details on the features and specifications of the products for proper and safe use. Please note that the contents may change without any prior notice due to reasons such as upgrading.

MMZ1608 type

ELECTRICAL CHARACTERISTICS

Z, X, R VS. FREQUENCY CHARACTERISTICS

MMZ1608Y471BTA00

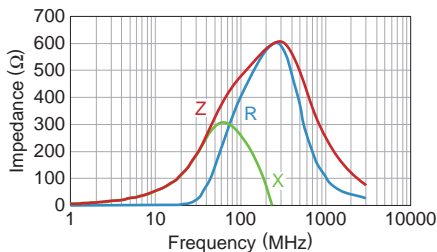

MMZ1608Y601BTA00

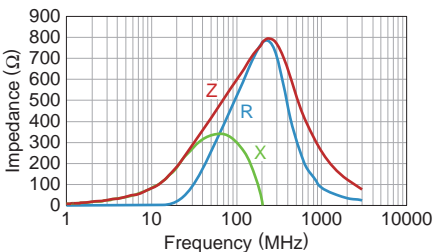

MMZ1608Y751BTA00

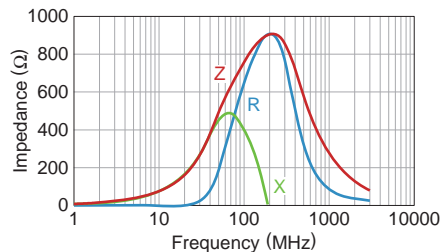

MMZ1608Y102BTA00

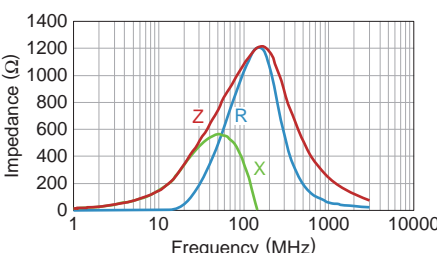

MMZ1608Y152BTA00

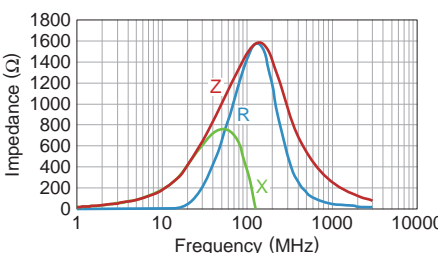

MMZ1608A182BTA00

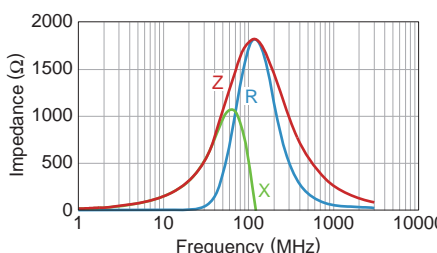

MMZ1608A222BTA00

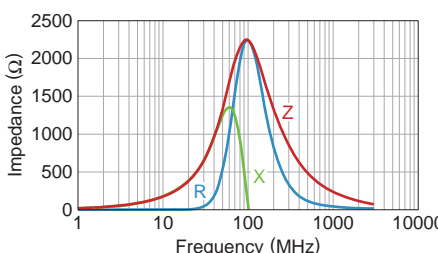

MMZ1608A252BTA00

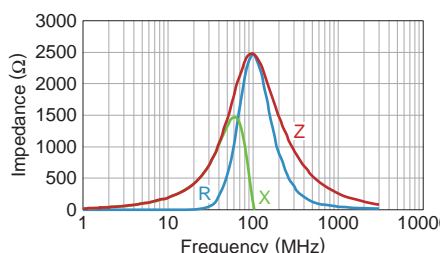

MMZ1608Q121BTA00

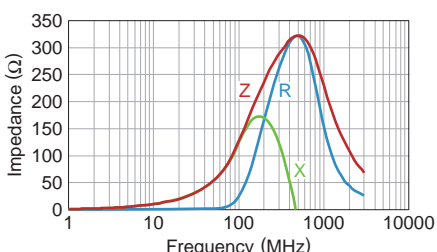

MMZ1608Q221BTA00

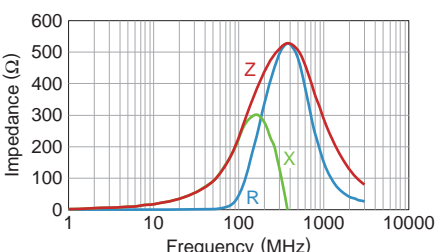

MMZ1608Q331BTA00

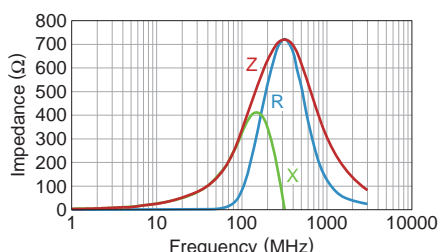

MMZ1608Q471BTA00

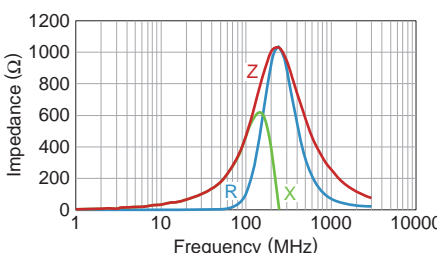

MMZ1608Q601BTA00

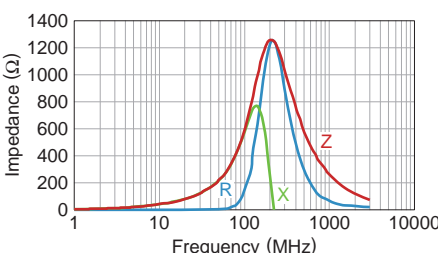

MMZ1608Q102BTA00

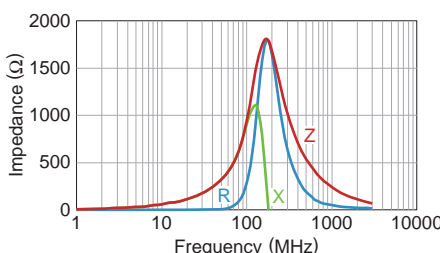

⚠ Please be sure to request delivery specifications that provide further details on the features and specifications of the products for proper and safe use. Please note that the contents may change without any prior notice due to reasons such as upgrading.

MMZ1608 type

ELECTRICAL CHARACTERISTICS

Z, X, R VS. FREQUENCY CHARACTERISTICS

MMZ1608D050CTA00

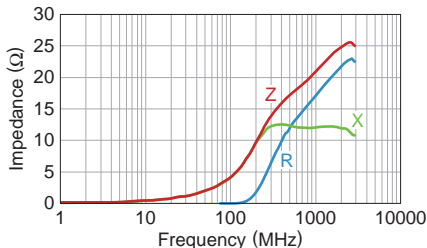

MMZ1608D100CTA00

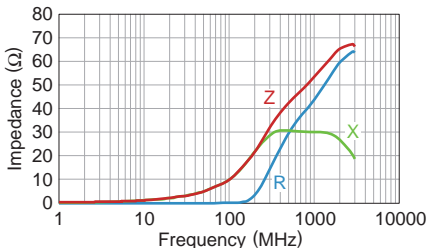

MMZ1608D220CTA00

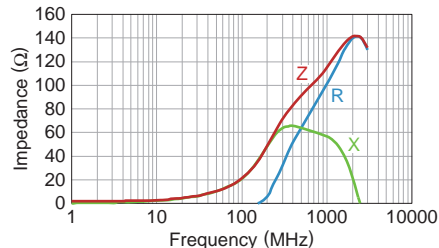

MMZ1608D500CTA00

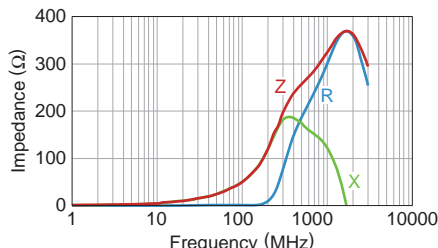

MMZ1608D800CTA00

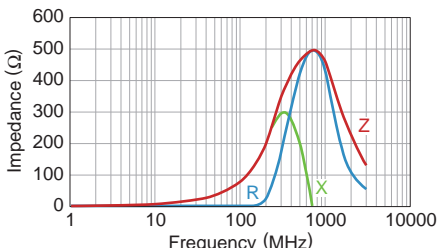

MMZ1608D800BTA00

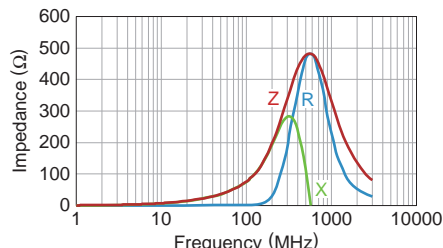

MMZ1608D121CTA00

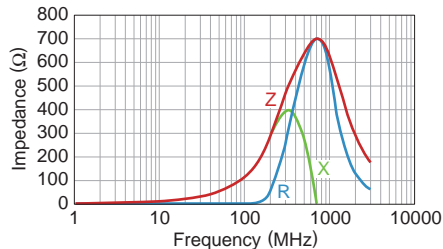

MMZ1608D121BTA00

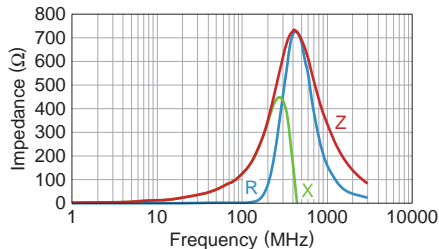

MMZ1608D241CTA00

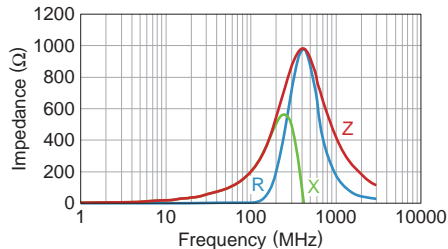

MMZ1608D301BTA00

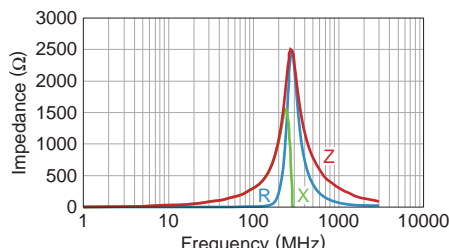

MMZ1608F030BTA00

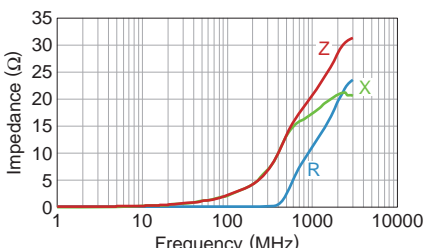

MMZ1608F470BTA00

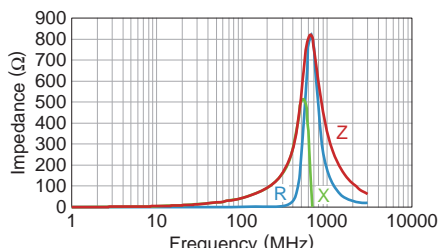

MMZ1608F750BTA00

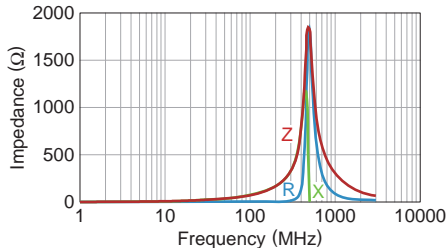

MMZ1608F121BTA00

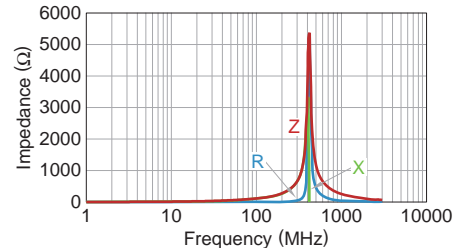

⚠ Please be sure to request delivery specifications that provide further details on the features and specifications of the products for proper and safe use. Please note that the contents may change without any prior notice due to reasons such as upgrading.

MMZ1608 type

PACKAGING STYLE

REEL DIMENSIONS

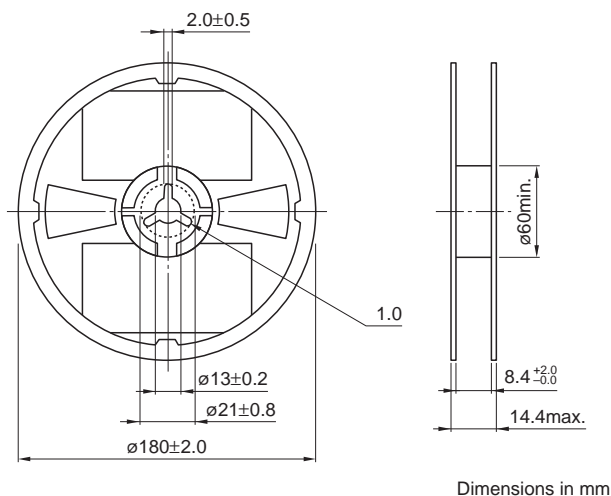

TAPE DIMENSIONS

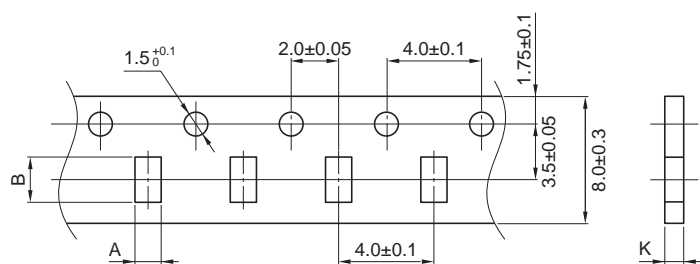

Type	A	B	P1	K
MMZ1608	1.1±0.2	1.9±0.2	4.0±0.1	1.1max.

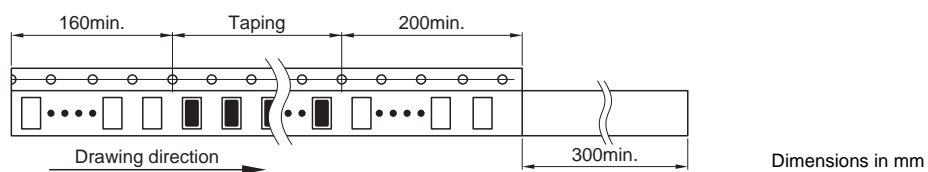

⚠ Please be sure to request delivery specifications that provide further details on the features and specifications of the products for proper and safe use. Please note that the contents may change without any prior notice due to reasons such as upgrading.