



## 3-terminal Filters, SMD Array

For differential signal line (cellular band compatible)

# MEA-LD series

---

<b>MEA1210LD</b>	<b>1210[0504 inch]*</b>
<b>MEA1608LD</b>	<b>1608[0603 inch]</b>
<b>MEA2010LD</b>	<b>2010[0804 inch]</b>

\* Dimensions Code JIS[EIA]

---

## REMINDERS FOR USING THESE PRODUCTS

Before using these products, be sure to request the delivery specifications.

### SAFETY REMINDERS

Please pay sufficient attention to the warnings for safe designing when using these products.

#### REMINDERS

- The storage period is less than 12 months. Be sure to follow the storage conditions (Temperature: 5 to 40°C, Humidity: 10 to 75% RH or less).  
If the storage period elapses, the soldering of the terminal electrodes may deteriorate.
- Do not use or store in locations where there are conditions such as gas corrosion (salt, acid, alkali, etc.).
- Before soldering, be sure to preheat components.  
The preheating temperature should be set so that the temperature difference between the solder temperature and chip temperature does not exceed 150°C.
- Soldering corrections after mounting should be within the range of the conditions determined in the specifications.  
If overheated, a short circuit, performance deterioration, or lifespan shortening may occur.
- When embedding a printed circuit board where a chip is mounted to a set, be sure that residual stress is not given to the chip due to the overall distortion of the printed circuit board and partial distortion such as at screw tightening portions.
- Self heating (temperature increase) occurs when the power is turned ON, so the tolerance should be sufficient for the set thermal design.
- Carefully lay out the coil for the circuit board design of the non-magnetic shield type.  
A malfunction may occur due to magnetic interference.
- Use a wrist band to discharge static electricity in your body through the grounding wire.
- Do not expose the products to magnets or magnetic fields.
- Do not use for a purpose outside of the contents regulated in the delivery specifications.
- The products listed on this catalog are intended for use in general electronic equipment (AV equipment, telecommunications equipment, home appliances, amusement equipment, computer equipment, personal equipment, office equipment, measurement equipment, industrial robots) under a normal operation and use condition.  
The products are not designed or warranted to meet the requirements of the applications listed below, whose performance and/or quality require a more stringent level of safety or reliability, or whose failure, malfunction or trouble could cause serious damage to society, person or property.  
If you intend to use the products in the applications listed below or if you have special requirements exceeding the range or conditions set forth in the each catalog, please contact us.

- (1) Aerospace/Aviation equipment
- (2) Transportation equipment (cars, electric trains, ships, etc.)
- (3) Medical equipment
- (4) Power-generation control equipment
- (5) Atomic energy-related equipment
- (6) Seabed equipment
- (7) Transportation control equipment

- (8) Public information-processing equipment
- (9) Military equipment
- (10) Electric heating apparatus, burning equipment
- (11) Disaster prevention/crime prevention equipment
- (12) Safety equipment
- (13) Other applications that are not considered general-purpose applications

When designing your equipment even for general-purpose applications, you are kindly requested to take into consideration securing protection circuit/device or providing backup circuits in your equipment.

# 3-terminal Filters, SMD Array

## For differential signal line (cellular band compatible)

Product compatible with RoHS directive  
Halogen-free  
Compatible with lead-free solders

# Overview of the MEA-LD Series

## FEATURES

- LC filter with differential lines (D+ and D-) for high-density mounting.
- Compact with a low profile design.
- Can reduce radiation noise generated from differential signal lines (LVDS, MIPI, MDDI).
- Effective as a desensitization countermeasure in information transmission terminals such as smart phones.

## APPLICATION

Noise removal for differential transmission lines (MIPI, etc.) of various mobile devices.

## PART NUMBER CONSTRUCTION

MEA	1210	LD	120	T	<input type="checkbox"/> <input type="checkbox"/> <input type="checkbox"/>		
Series name	LxWxT Dimensions (mm)		Product internal code	Capacitance (pF)		Packaging style	Internal code
	1210	1.2x1.0x0.5		LD	120		
	1608	1.6x0.8x0.5		170	17		
	2010	2.0x1.0x0.5					

## OPERATING TEMPERATURE RANGE, PACKAGE QUANTITY, PRODUCT WEIGHT

Type	Temperature range		Package quantity	Individual weight
	Operating temperature	Storage temperature*		
	(°C)	(°C)	(pieces/reel)	(mg)
MEA1210LD	-40 to +85	-40 to +85	4,000	3
MEA1608LD	-40 to +85	-40 to +85	4,000	3.5
MEA2010LD	-40 to +85	-40 to +85	4,000	5

\* The Storage temperature range is for after the circuit board is mounted.

- RoHS Directive Compliant Product: See the following for more details related to RoHS Directive compliant products. <http://www.tdk.co.jp/rohs/>
- Halogen-free: Indicates that Cl content is less than 900ppm, Br content is less than 900ppm, and that the total Cl and Br content is less than 1500ppm.

• All specifications are subject to change without notice.

# Overview of the MEA-LD Series

## RECOMMENDED REFLOW PROFILE



Preheating			Soldering		Peak	
Temp.	Temp.	Time	Temp.	Time	Temp.	Time
T1	T2	t1	T3	t2	T4	t3
150°C	180°C	60 to 120s	230°C	30 to 60s	250 to 260°C	10s max.

# MEA-LD series

# MEA1210LD Type



## SHAPE & DIMENSIONS

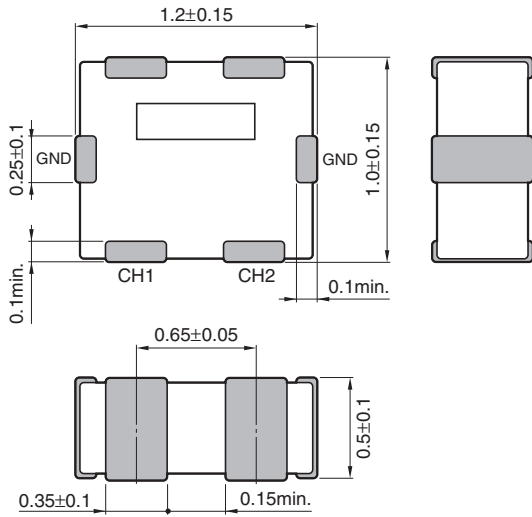

Dimensions in mm

## RECOMMENDED LAND PATTERN

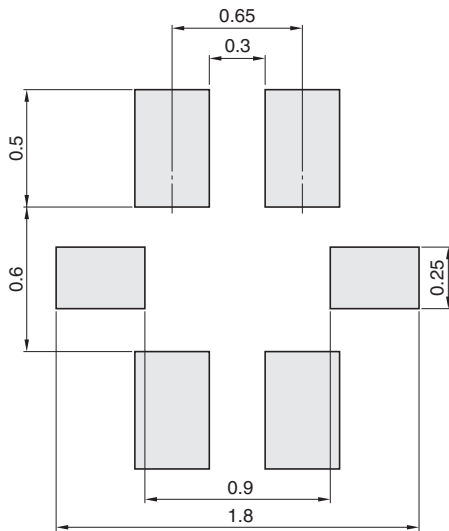

Dimensions in mm

## CIRCUIT DIAGRAM

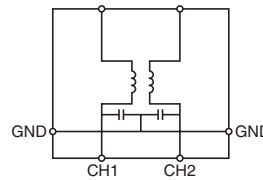

• All specifications are subject to change without notice.

# MEA-LD series MEA1210LD Type

## ELECTRICAL CHARACTERISTICS

### CHARACTERISTICS SPECIFICATION TABLE

Capacitance (pF)	Cutoff frequency (MHz)typ.	Rated voltage (V)max.	Rated current (mA)max.	Part No.
22	250(Sdd)	6.3	100	MEA1210LD220T□□□
17	310(Sdd)	6.3	100	MEA1210LD170T□□□
12	410(Sdd)	6.3	100	MEA1210LD120T□□□

○ Measurement equipment

Measurement item	Product No.	Manufacturer
Capacitance	4294A	Agilent Technologies
Frequency characteristics	N5230C	Agilent Technologies

\* Equivalent measurement equipment may be used.

### INSERTION LOSS VS. FREQUENCY CHARACTERISTICS

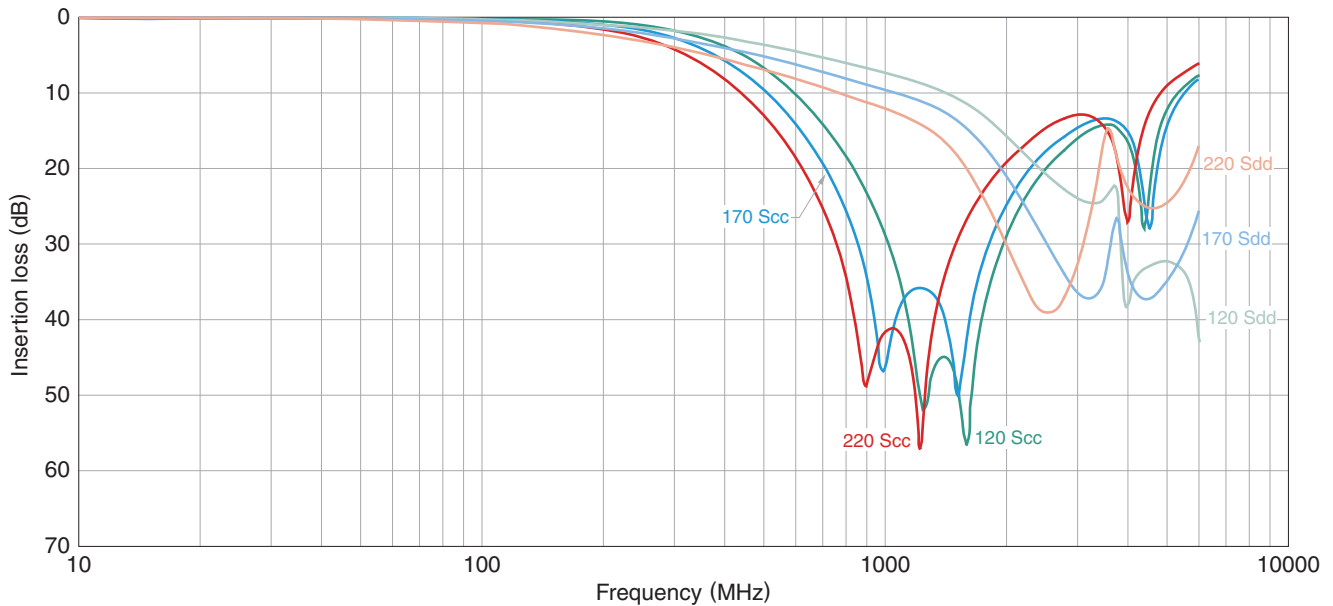

○ Measurement equipment

Product No.	Manufacturer
N5230C	Agilent Technologies

\* Equivalent measurement equipment may be used.

• All specifications are subject to change without notice.

MEA-LD series

# MEA1608LD Type



## SHAPE & DIMENSIONS

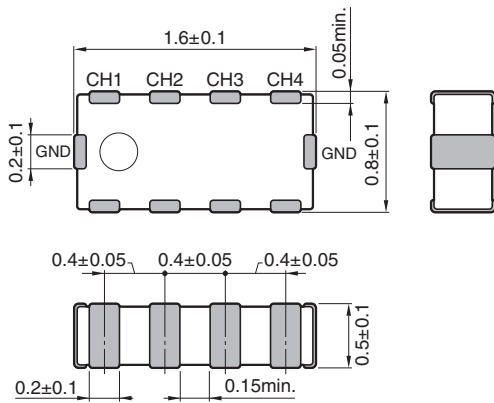

Dimensions in mm

## RECOMMENDED LAND PATTERN

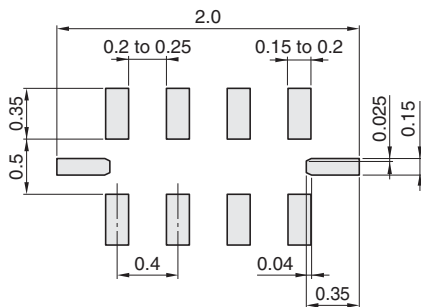

Dimensions in mm

## CIRCUIT DIAGRAM

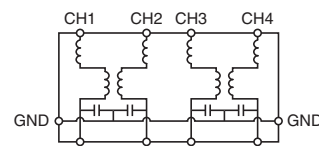

# MEA-LD series MEA1608LD Type

## ELECTRICAL CHARACTERISTICS

### CHARACTERISTICS SPECIFICATION TABLE

Capacitance (pF)	Cutoff frequency (MHz)typ.	Rated voltage (V)max.	Rated current (mA)max.	Part No.
22	270(Sdd)	6.3	50	MEA1608LD220T□□□
15	380(Sdd)	6.3	50	MEA1608LD150T□□□
10	500(Sdd)	6.3	50	MEA1608LD100T□□□

#### Measurement equipment

Measurement item	Product No.	Manufacturer
Capacitance	4294A	Agilent Technologies
Frequency characteristics	N5230C	Agilent Technologies

\* Equivalent measurement equipment may be used.

### INSERTION LOSS VS. FREQUENCY CHARACTERISTICS

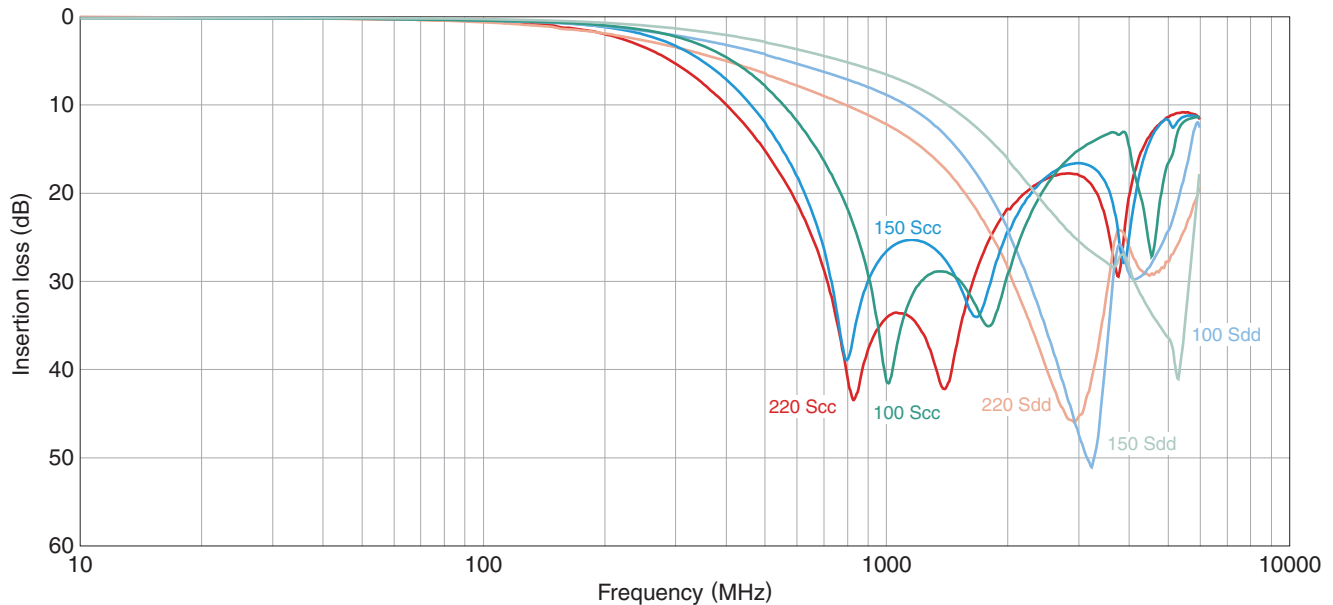

#### Measurement equipment

Product No.	Manufacturer
N5230C	Agilent Technologies

\* Equivalent measurement equipment may be used.



# MEA-LD series

# MEA2010LD Type

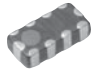

## SHAPE & DIMENSIONS

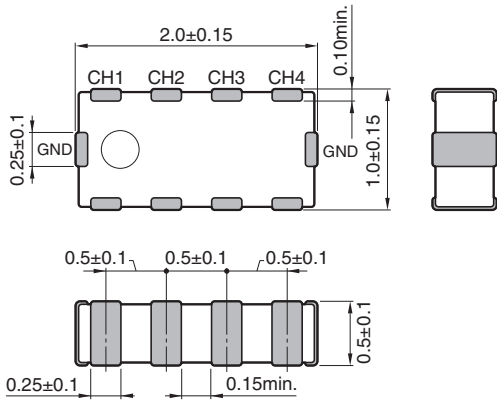

Dimensions in mm

## RECOMMENDED LAND PATTERN

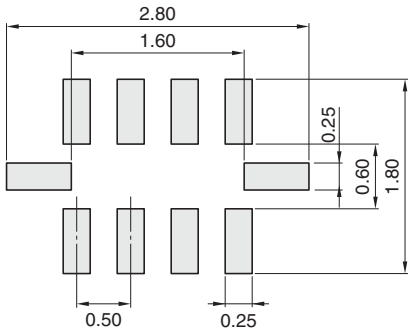

Dimensions in mm

## CIRCUIT DIAGRAM

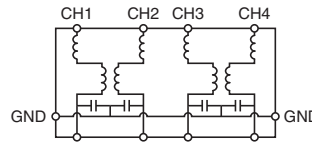

• All specifications are subject to change without notice.

# MEA-LD series MEA2010LD Type

## ELECTRICAL CHARACTERISTICS

### CHARACTERISTICS SPECIFICATION TABLE

Capacitance (pF)	Cutoff frequency (MHz)typ.	Rated voltage (V)max.	Rated current (mA)max.	Part No.
22	240(Sdd)	6.3	100	MEA2010LD220T□□□
17	330(Sdd)	6.3	100	MEA2010LD170T□□□
12	430(Sdd)	6.3	100	MEA2010LD120T□□□

○ Measurement equipment

Measurement item	Product No.	Manufacturer
Capacitance	4294A	Agilent Technologies
Frequency characteristics	N5230C	Agilent Technologies

\* Equivalent measurement equipment may be used.

### INSERTION LOSS VS. FREQUENCY CHARACTERISTICS

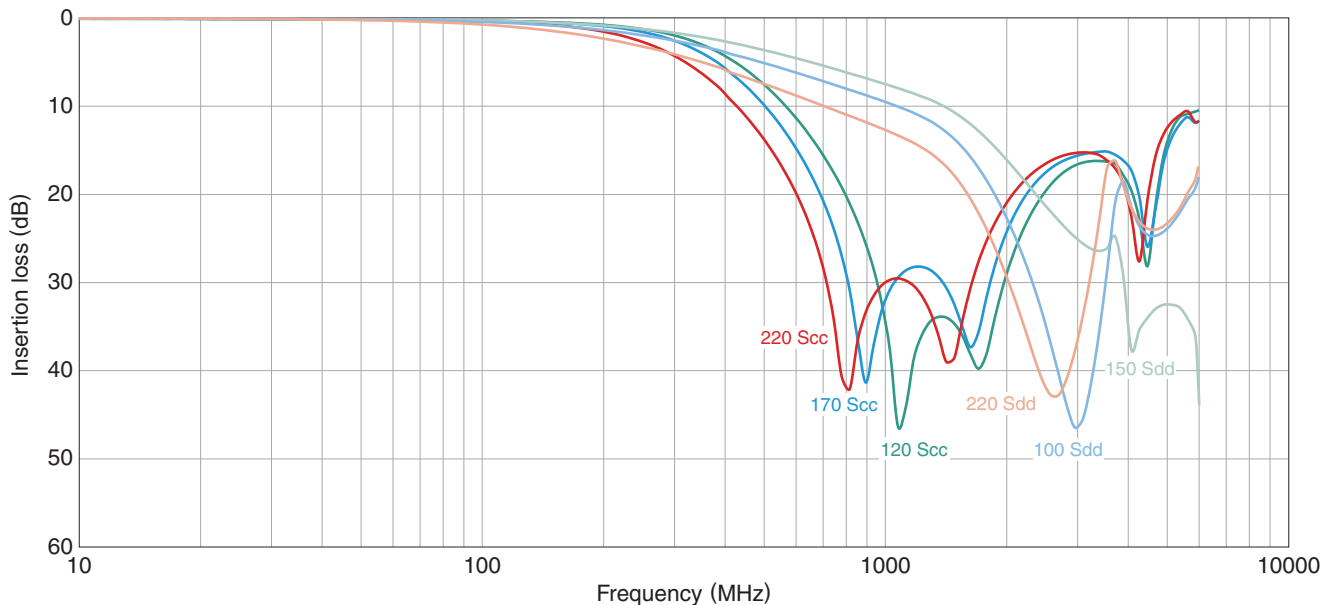

○ Measurement equipment

Product No.	Manufacturer
N5230C	Agilent Technologies

\* Equivalent measurement equipment may be used.

• All specifications are subject to change without notice.

# MEA-LD series

# Packaging style

## REEL DIMENSIONS

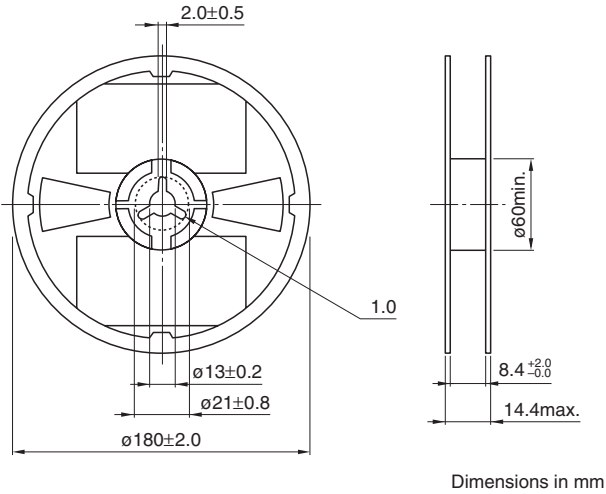

Dimensions in mm

## TAPE DIMENSIONS

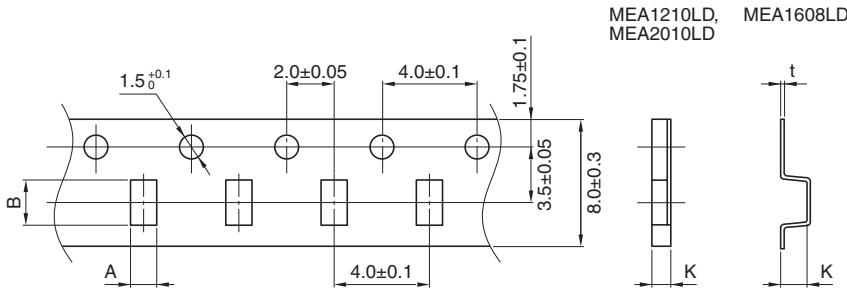

Dimensions in mm

Type	A	B	K	t
MEA1210LD	1.20±0.05	1.45±0.05	0.73max.	—
MEA1608LD	1.00±0.10	1.80±0.10	1.0max.	0.25±0.05
MEA2010LD	1.15±0.05	2.15±0.05	1.0max.	—

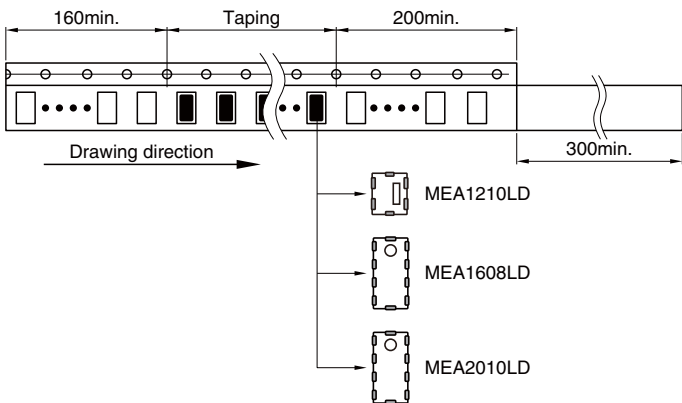

Dimensions in mm

• All specifications are subject to change without notice.