



# Inductors for Power Circuits

Multilayer Ferrite

**MLJ Series**

# MLJ1608 Type

---

**MLJ1608**

**1608 [0603 inch]\***

\* Dimensions Code JIS[EIA]

## REMINDERS FOR USING THESE PRODUCTS

Before using these products, be sure to request the delivery specifications.

### SAFETY REMINDERS

Please pay sufficient attention to the warnings for safe designing when using these products.

#### REMINDERS

- The storage period is less than 12 months. Be sure to follow the storage conditions (Temperature: 5 to 40°C, Humidity: 10 to 75% RH or less).  
If the storage period elapses, the soldering of the terminal electrodes may deteriorate.
- Do not use or store in locations where there are conditions such as gas corrosion (salt, acid, alkali, etc.).
- Before soldering, be sure to preheat components.  
The preheating temperature should be set so that the temperature difference between the solder temperature and chip temperature does not exceed 150°C.
- Soldering corrections after mounting should be within the range of the conditions determined in the specifications.  
If overheated, a short circuit, performance deterioration, or lifespan shortening may occur.
- When embedding a printed circuit board where a chip is mounted to a set, be sure that residual stress is not given to the chip due to the overall distortion of the printed circuit board and partial distortion such as at screw tightening portions.
- Self heating (temperature increase) occurs when the power is turned ON, so the tolerance should be sufficient for the set thermal design.
- Carefully lay out the coil for the circuit board design of the non-magnetic shield type.  
A malfunction may occur due to magnetic interference.
- Use a wrist band to discharge static electricity in your body through the grounding wire.
- Do not expose the products to magnets or magnetic fields.
- Do not use for a purpose outside of the contents regulated in the delivery specifications.
- The products listed on this catalog are intended for use in general electronic equipment (AV equipment, telecommunications equipment, home appliances, amusement equipment, computer equipment, personal equipment, office equipment, measurement equipment, industrial robots) under a normal operation and use condition.  
The products are not designed or warranted to meet the requirements of the applications listed below, whose performance and/or quality require a more stringent level of safety or reliability, or whose failure, malfunction or trouble could cause serious damage to society, person or property.  
If you intend to use the products in the applications listed below or if you have special requirements exceeding the range or conditions set forth in the each catalog, please contact us.

- (1) Aerospace/Aviation equipment
- (2) Transportation equipment (cars, electric trains, ships, etc.)
- (3) Medical equipment
- (4) Power-generation control equipment
- (5) Atomic energy-related equipment
- (6) Seabed equipment
- (7) Transportation control equipment

- (8) Public information-processing equipment
- (9) Military equipment
- (10) Electric heating apparatus, burning equipment
- (11) Disaster prevention/crime prevention equipment
- (12) Safety equipment
- (13) Other applications that are not considered general-purpose applications

When designing your equipment even for general-purpose applications, you are kindly requested to take into consideration securing protection circuit/device or providing backup circuits in your equipment.

# Inductors for Power Circuits

## Multilayer Ferrite

Product compatible with RoHS directive  
Halogen-free  
Compatible with lead-free solders

# Overview of MLJ1608 Type

## FEATURES

- The large current response by ferrite material of the new development.
- Narrow tolerance response by lamination of high precision.
- Significantly reduce high-frequency Loss by adopting a low-loss material.

## APPLICATION

NFC circuit for smart phones and PCs, power supply lines for various electronic devices

## PART NUMBER CONSTRUCTION

MLJ	1608		W	R16		△	T		000		
Series name	LxWxH Dimensions (mm)		Characteristics		Inductance (μH)		Inductance tolerance		Packaging style	Internal code	
	1608	1.6x0.8x0.8	W	Large current	R16	160	J	±5%	T	Taping	000
					R33	330	K	±10%			
					R56	560					

## OPERATING TEMPERATURE RANGE, PACKAGE QUANTITY, PRODUCT WEIGHT

Type	Temperature range		Package quantity (pieces/reel)	Individual weight (mg)
	Operating temperature (°C)	Storage temperature* (°C)		
MLJ1608	-55 to +125	-55 to +125	4,000	4

\* The Storage temperature range is for after the circuit board is mounted.

- RoHS Directive Compliant Product: See the following for more details related to RoHS Directive compliant products. <http://product.tdk.com/en/environment/rohs/>
- Halogen-free: Indicates that Cl content is less than 900ppm, Br content is less than 900ppm, and that the total Cl and Br content is less than 1500ppm.

 Please be sure to request delivery specifications that provide further details on the features and specifications of the products for proper and safe use.  
Please note that the contents may change without any prior notice due to reasons such as upgrading.

# MLJ1608 Type

## RECOMMENDED REFLOW PROFILE

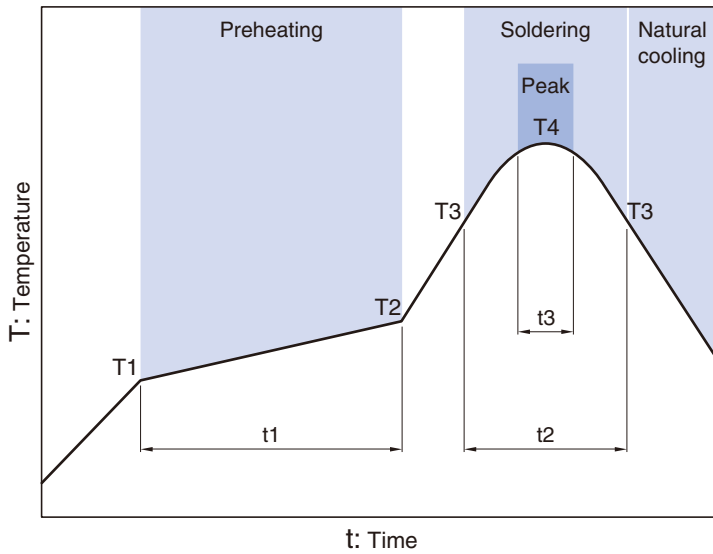

Preheating			Soldering		Peak	
Temp.	Temp.	Time	Temp.	Time	Temp.	Time
T1	T2	t1	T3	t2	T4	t3
150°C	180°C	60 to 120s	230°C	30 to 60s	250 to 260°C	10s max.

# MLJ1608 Type

## ■ SHAPE & DIMENSIONS

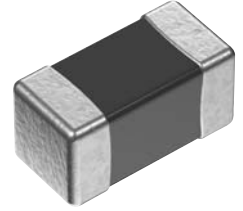
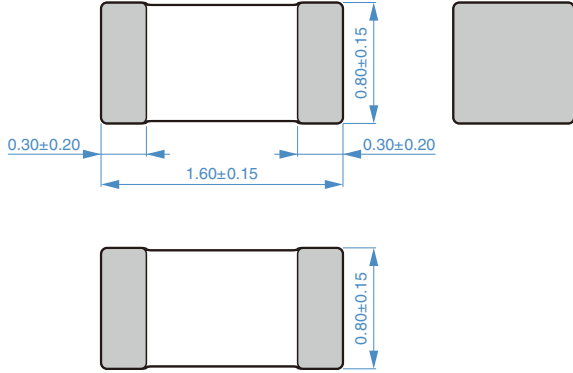

Dimensions in mm

## ■ RECOMMENDED LAND PATTERN

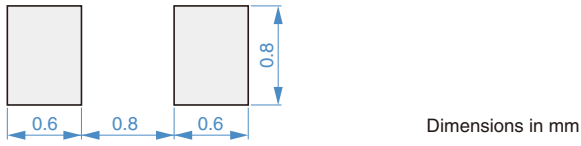

Dimensions in mm

 Please be sure to request delivery specifications that provide further details on the features and specifications of the products for proper and safe use. Please note that the contents may change without any prior notice due to reasons such as upgrading.

# MLJ1608 Type

## ELECTRICAL CHARACTERISTICS

### CHARACTERISTICS SPECIFICATION TABLE

L (nH)	Q Tolerance	L, Q measuring conditions		Self-resonant frequency		DC resistance ( $\Omega$ )	Rated current			Part No.*	
		min.	Frequency (MHz)	Current (mA)	min. (MHz)		typ. (MHz)	Idc-1 (mA)typ.	Idc-1 (mA)max.		Idc-2 (mA)max.
160	$\pm 5\% \pm 10\%$	25	25	1.0	330	450	0.12 $\pm$ 30%	750	600	700	MLJ1608WR16 $\triangle$ T000
220	$\pm 5\% \pm 10\%$	25	25	1.0	290	400	0.20 $\pm$ 30%	700	550	600	MLJ1608WR22 $\triangle$ T000
270	$\pm 5\% \pm 10\%$	25	25	1.0	260	350	0.22 $\pm$ 30%	650	550	550	MLJ1608WR27 $\triangle$ T000
330	$\pm 5\% \pm 10\%$	25	25	1.0	230	320	0.24 $\pm$ 30%	650	500	500	MLJ1608WR33 $\triangle$ T000
390	$\pm 5\% \pm 10\%$	25	25	1.0	210	290	0.28 $\pm$ 30%	600	450	450	MLJ1608WR39 $\triangle$ T000
470	$\pm 5\% \pm 10\%$	25	25	1.0	190	260	0.38 $\pm$ 30%	600	400	400	MLJ1608WR47 $\triangle$ T000
560	$\pm 5\% \pm 10\%$	25	25	1.0	170	230	0.40 $\pm$ 30%	550	400	400	MLJ1608WR56 $\triangle$ T000

\* The "  $\triangle$  " of the Part Number contains the inductance tolerance code, J ( $\pm 5\%$ ) or K ( $\pm 10\%$ )

#### Measurement equipment

Measurement item	Product No.	Manufacturer
L, Q	4294A+16034G	Keysight Technologies
Self-resonant frequency	E4991A	Keysight Technologies
DC resistance	Type-7561	Yokogawa

\* Equivalent measurement equipment may be used.

# MLJ1608 Type

## ELECTRICAL CHARACTERISTICS

### L FREQUENCY CHARACTERISTICS GRAPH

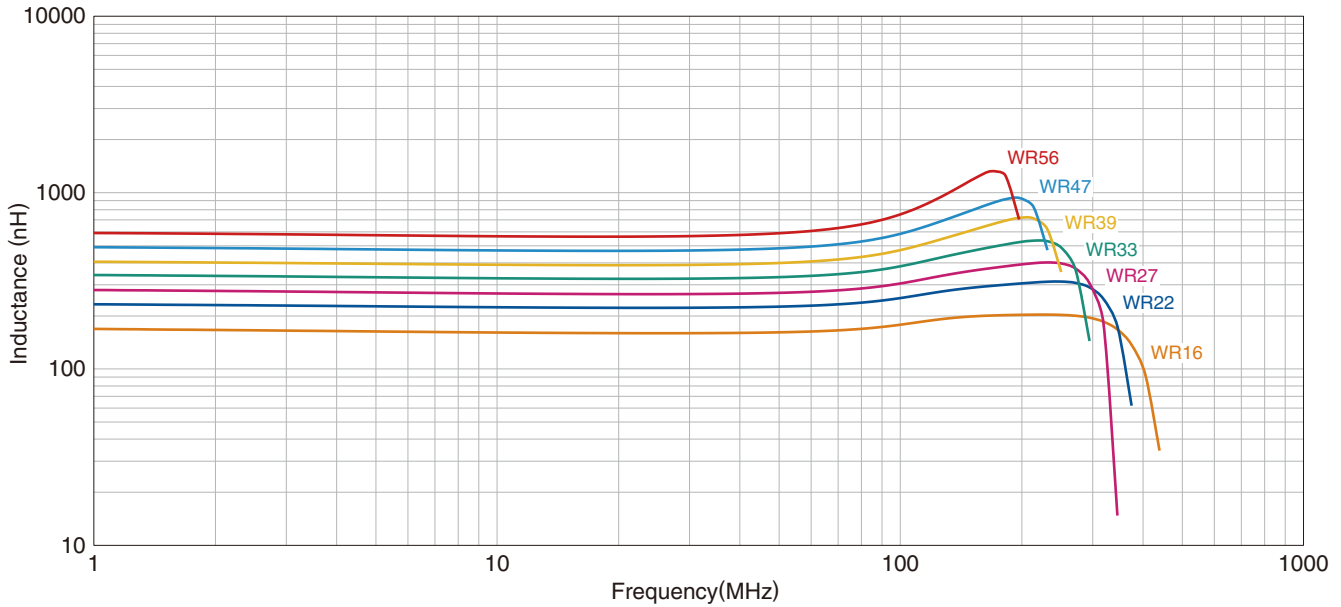

○ Measurement equipment

Product No.	Manufacturer
E4991A+16192A	Keysight Technologies

\* Equivalent measurement equipment may be used.

### Q FREQUENCY CHARACTERISTICS GRAPH

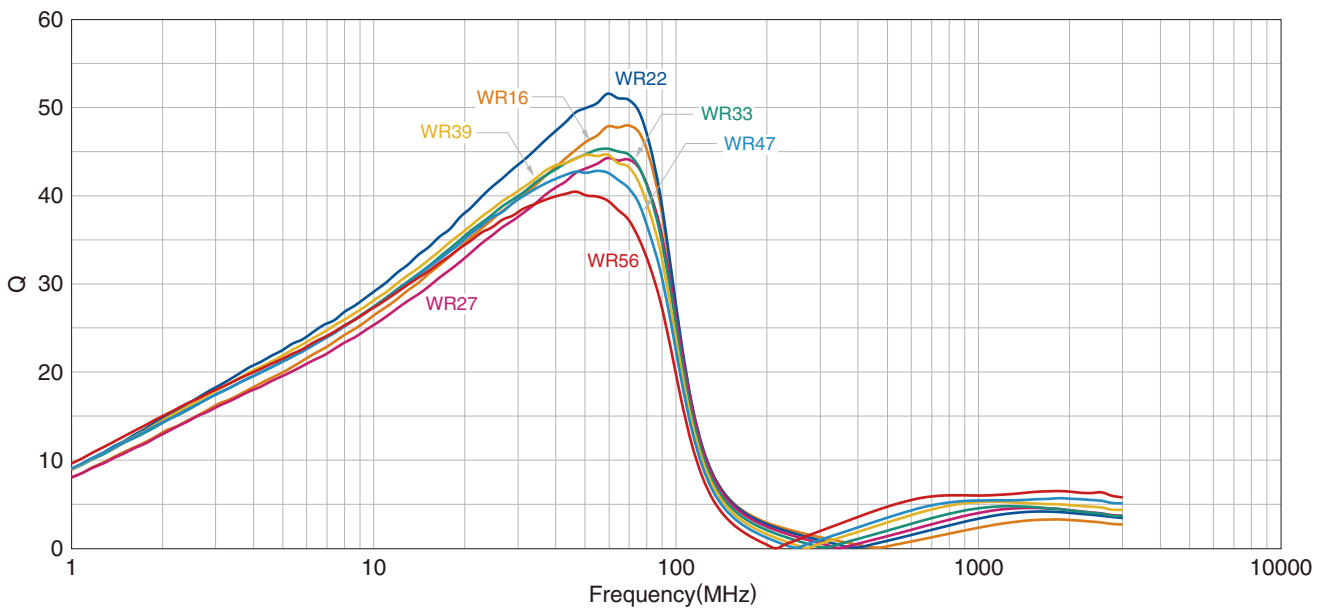

○ Measurement equipment

Product No.	Manufacturer
4294A+16034G	Keysight Technologies

\* Equivalent measurement equipment may be used.

 Please be sure to request delivery specifications that provide further details on the features and specifications of the products for proper and safe use. Please note that the contents may change without any prior notice due to reasons such as upgrading.

# MLJ1608 Type

## PACKAGING STYLE

### REEL DIMENSIONS

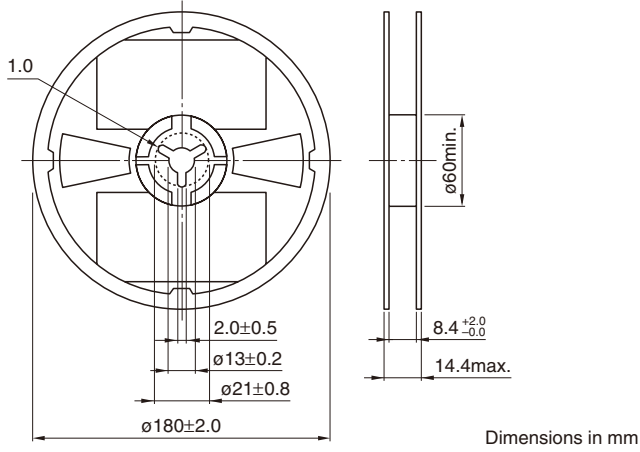

### TAPE DIMENSIONS

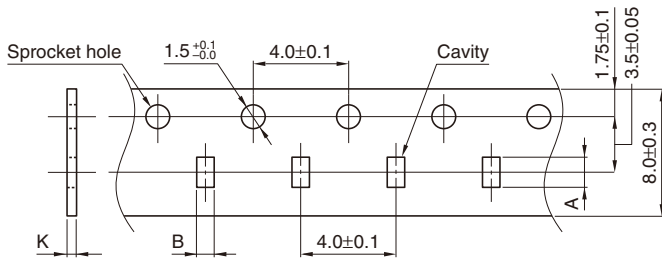

Type	A	B	K
MLJ1608	$1.9 \pm 0.2$	$1.1 \pm 0.2$	1.1 max.

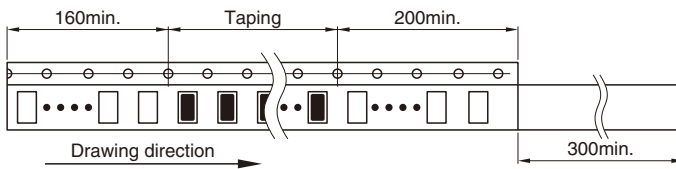

Dimensions in mm