



# Inductors for Power Circuits

Multilayer Ferrite

**MLP Series**

# MLP2520 Type

---

**MLP2520**

**2520 [1008 inch]\***

\* Dimensions Code JIS[EIA]

## REMINDERS FOR USING THESE PRODUCTS

Before using these products, be sure to request the delivery specifications.

### SAFETY REMINDERS

Please pay sufficient attention to the warnings for safe designing when using these products.

#### REMINDERS

- The storage period is less than 12 months. Be sure to follow the storage conditions (Temperature: 5 to 40°C, Humidity: 10 to 75% RH or less).  
If the storage period elapses, the soldering of the terminal electrodes may deteriorate.
- Do not use or store in locations where there are conditions such as gas corrosion (salt, acid, alkali, etc.).
- Before soldering, be sure to preheat components.  
The preheating temperature should be set so that the temperature difference between the solder temperature and chip temperature does not exceed 150°C.
- Soldering corrections after mounting should be within the range of the conditions determined in the specifications.  
If overheated, a short circuit, performance deterioration, or lifespan shortening may occur.
- When embedding a printed circuit board where a chip is mounted to a set, be sure that residual stress is not given to the chip due to the overall distortion of the printed circuit board and partial distortion such as at screw tightening portions.
- Self heating (temperature increase) occurs when the power is turned ON, so the tolerance should be sufficient for the set thermal design.
- Carefully lay out the coil for the circuit board design of the non-magnetic shield type.  
A malfunction may occur due to magnetic interference.
- Use a wrist band to discharge static electricity in your body through the grounding wire.
- Do not expose the products to magnets or magnetic fields.
- Do not use for a purpose outside of the contents regulated in the delivery specifications.
- The products listed on this catalog are intended for use in general electronic equipment (AV equipment, telecommunications equipment, home appliances, amusement equipment, computer equipment, personal equipment, office equipment, measurement equipment, industrial robots) under a normal operation and use condition.  
The products are not designed or warranted to meet the requirements of the applications listed below, whose performance and/or quality require a more stringent level of safety or reliability, or whose failure, malfunction or trouble could cause serious damage to society, person or property.  
If you intend to use the products in the applications listed below or if you have special requirements exceeding the range or conditions set forth in the each catalog, please contact us.

- (1) Aerospace/Aviation equipment
- (2) Transportation equipment (cars, electric trains, ships, etc.)
- (3) Medical equipment
- (4) Power-generation control equipment
- (5) Atomic energy-related equipment
- (6) Seabed equipment
- (7) Transportation control equipment

- (8) Public information-processing equipment
- (9) Military equipment
- (10) Electric heating apparatus, burning equipment
- (11) Disaster prevention/crime prevention equipment
- (12) Safety equipment
- (13) Other applications that are not considered general-purpose applications

When designing your equipment even for general-purpose applications, you are kindly requested to take into consideration securing protection circuit/device or providing backup circuits in your equipment.

# Inductors for Power Circuits

## Multilayer Ferrite

Product compatible with RoHS directive  
Halogen-free  
Compatible with lead-free solders

# Overview of MLP2520 Type

## FEATURES

- A low-loss magnetic material is used so that a low-loss inductor for the power supply circuit can be achieved.
- In addition to the inductance value, product types with various features are available so that they can be compatible with different usages.
  - W Type: Products with low DC resistance and large current.
  - H Type: This product uses a low-loss material and has low DC resistance.
    - \* Optimal for when heavy load power efficiency is important.
  - V Type: As with the H type, this product with a low-loss magnetic material and that has good DC superimposition type characteristics.
    - \* Optimal for when light load power efficiency is important.
  - S Type: STD product lineup that includes a wide L value and various sizes.

## APPLICATION

Smart phones, tablet terminals, digital cameras, video cameras, HDDs, power supply modules, etc.

## PART NUMBER CONSTRUCTION

MLP	2520		W		R47		M		T		0S1
Series name	L×W Dimensions (mm)		Characteristic type		Inductance (μH)		Height (mm max.)		Packaging style		Internal code
	2520	2.5×2.0	W	Large current, low resistance	R47	0.47	M	1.0	T	Taping	0S1
			H	Low core loss (Emphasized DC resistance)	1R0	1.0	S	1.2			
			V	Low core loss (Emphasized DC bias characteristics)	100	10					
			S	STD product							

## OPERATING TEMPERATURE RANGE, PACKAGE QUANTITY, PRODUCT WEIGHT

Type	Temperature range		Package quantity (pieces/reel)	Individual weight (mg)
	Operating temperature* (°C)	Storage temperature** (°C)		
MLP2520	t=1.0	-40 to +125	3,000	15
	t=1.2			25

\* Operating temperature range includes self-temperature rise.

\*\* The Storage temperature range is for after the circuit board is mounted.

- RoHS Directive Compliant Product: See the following for more details related to RoHS Directive compliant products. <http://product.tdk.com/en/environment/rohs/>
- Halogen-free: Indicates that Cl content is less than 900ppm, Br content is less than 900ppm, and that the total Cl and Br content is less than 1500ppm.

 Please be sure to request delivery specifications that provide further details on the features and specifications of the products for proper and safe use. Please note that the contents may change without any prior notice due to reasons such as upgrading.

# MLP2520 Type

## RECOMMENDED REFLOW PROFILE



Preheating			Soldering		Peak	
Temp.	Temp.	Time	Temp.	Time	Temp.	Time
T1	T2	t1	T3	t2	T4	t3
150°C	180°C	60 to 120s	230°C	30 to 60s	250 to 260°C	10s max.

# MLP2520 Type

## SHAPE & DIMENSIONS

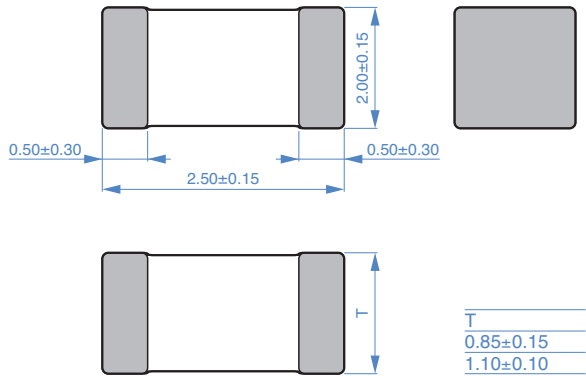

Dimensions in mm

## RECOMMENDED LAND PATTERN

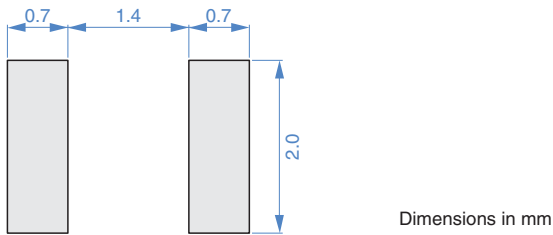

Dimensions in mm

Please be sure to request delivery specifications that provide further details on the features and specifications of the products for proper and safe use. Please note that the contents may change without any prior notice due to reasons such as upgrading.

## MLP2520 Type

## ELECTRICAL CHARACTERISTICS

## CHARACTERISTICS SPECIFICATION TABLE

Type	Thickness	L		Measuring frequency	DC resistance	Rated current*	Part No.
		T	tolerance				
	(mm)max.	(μH)		(MHz)	(Ω)±30%	(mA)max.	
Large current	Low resistance	1.0	0.47 ±20%	2	0.033	2900	MLP2520WR47MT0S1
		1.0	0.68 ±20%	2	0.040	2800	MLP2520WR68MT0S1
		1.0	1.0 ±20%	2	0.048	2300	MLP2520W1R0MT0S1
		1.0	1.5 ±20%	2	0.075	1800	MLP2520W1R5MT0S1
		1.0	2.2 ±20%	2	0.16	1200	MLP2520W2R2MT0S1
		1.0	3.3 ±20%	2	0.16	1200	MLP2520W3R3MT0S1
		1.0	4.7 ±20%	2	0.15	1200	MLP2520W4R7MT0S1
Low core loss	Emphasized low resistance	1.0	0.47 ±20%	2	0.044	2100	MLP2520HR47MT0S1
		1.0	1.0 ±20%	2	0.075	1500	MLP2520H1R0MT0S1
		1.0	2.2 ±20%	2	0.09	1300	MLP2520H2R2MT0S1
		1.0	3.3 ±20%	2	0.13	1100	MLP2520H3R3MT0S1
		1.0	4.7 ±20%	2	0.13	1000	MLP2520H4R7MT0S1
	Emphasized DC bias characteristics	1.2	1.0 ±20%	2	0.07	1600	MLP2520H1R0ST0S1
		1.2	2.2 ±20%	2	0.08	1500	MLP2520H2R2ST0S1
		1.2	4.7 ±20%	2	0.13	1000	MLP2520H4R7ST0S1
		1.0	0.47 ±20%	2	0.06	1700	MLP2520VR47MT0S1
		1.0	1.0 ±20%	2	0.10	1300	MLP2520V1R0MT0S1
STD product	Emphasized DC bias characteristics	1.0	1.5 ±20%	2	0.10	1400	MLP2520V1R5MT0S1
		1.0	2.2 ±20%	2	0.12	1100	MLP2520V2R2MT0S1
		1.0	3.3 ±20%	2	0.20	900	MLP2520V3R3MT0S1
		1.0	4.7 ±20%	2	0.24	800	MLP2520V4R7MT0S1
		1.2	1.0 ±20%	2	0.10	1300	MLP2520V1R0ST0S1
		1.2	1.5 ±20%	2	0.10	1400	MLP2520V1R5ST0S1
		1.2	2.2 ±20%	2	0.12	1100	MLP2520V2R2ST0S1
		1.2	4.7 ±20%	2	0.22	800	MLP2520V4R7ST0S1
		1.0	1.0 ±20%	2	0.085	1500	MLP2520S1R0MT0S1
		1.0	1.5 ±20%	2	0.09	1200	MLP2520S1R5MT0S1
	1.0	2.2 ±20%	2	0.09	1200	MLP2520S2R2MT0S1	
	1.0	3.3 ±20%	2	0.13	1000	MLP2520S3R3MT0S1	
	1.0	4.7 ±20%	2	0.13	1000	MLP2520S4R7MT0S1	
	1.0	10.0 ±20%	2	0.28	700	MLP2520S100MT0S1	
	1.2	1.2 ±20%	2	0.08	1500	MLP2520S1R0ST0S1	
	1.2	2.5 ±20%	2	0.11	1200	MLP2520S2R2ST0S1	
	1.2	3.3 ±20%	2	0.11	1000	MLP2520S3R3ST0S1	
	1.2	4.7 ±20%	2	0.11	1000	MLP2520S4R7ST0S1	
	1.2	10.0 ±20%	2	0.28	700	MLP2520S100ST0S1	

\* Rated current: Current assumed when temperature has risen to 40°C max.

## ○ Measurement equipment

Measurement item	Product No.	Manufacturer
L	4294A+16034G	Agilent Technologies
DC resistance	Type-7561	Yokogawa

\* Equivalent measurement equipment may be used.

# MLP2520 Type (W characteristic product, T dimension of the product 1.0mm max.)

## ELECTRICAL CHARACTERISTICS

### L FREQUENCY CHARACTERISTICS GRAPH

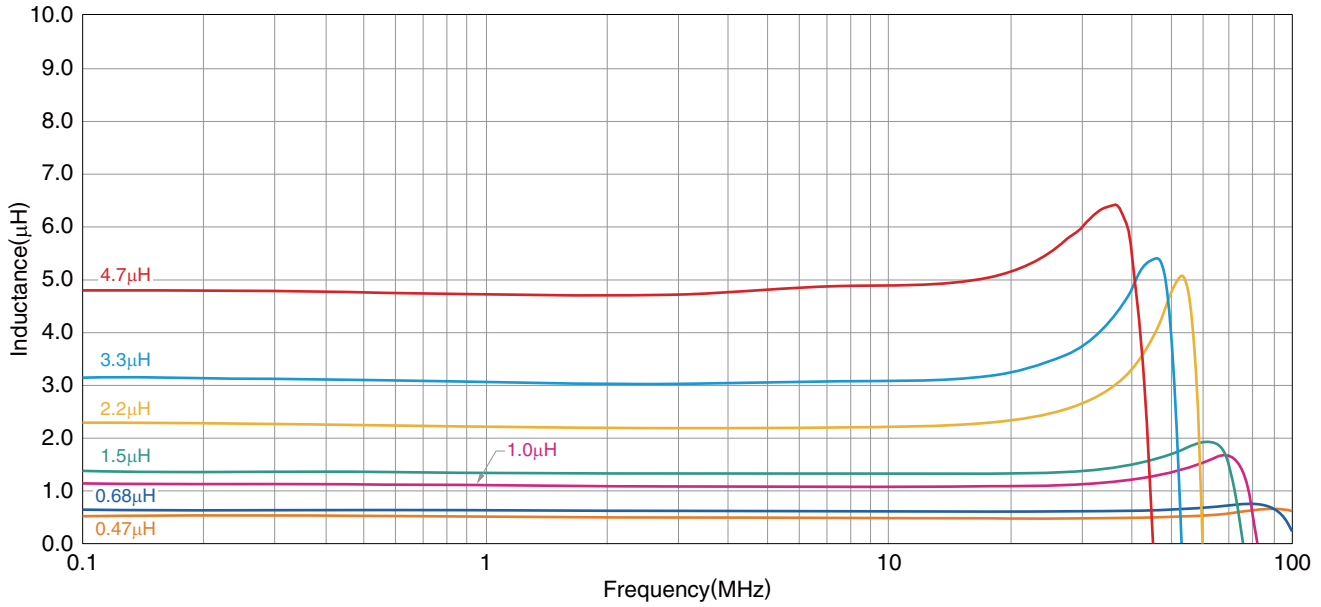

○ Measurement equipment

Product No.	Manufacturer
4294A+16034G	Agilent Technologies

\* Equivalent measurement equipment may be used.

 Please be sure to request delivery specifications that provide further details on the features and specifications of the products for proper and safe use. Please note that the contents may change without any prior notice due to reasons such as upgrading.

# MLP2520 Type (W characteristic product, T dimension of the product 1.0mm max.)

## ELECTRICAL CHARACTERISTICS

### INDUCTANCE VS. DC BIAS CHARACTERISTICS GRAPH

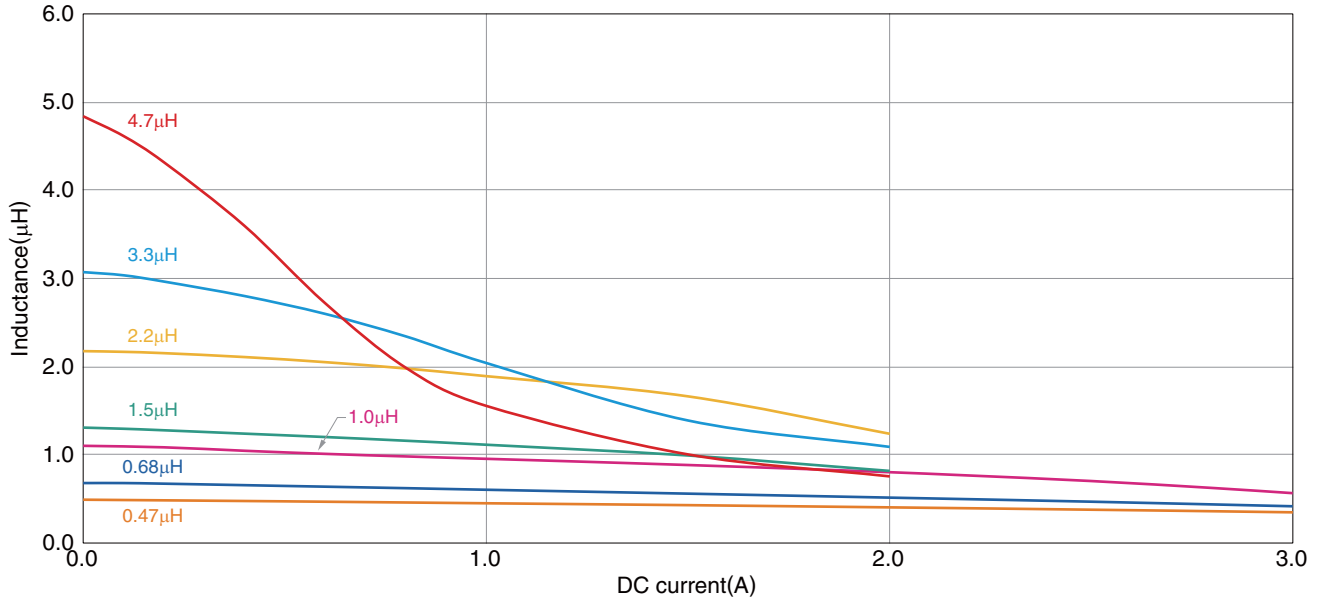

○ Measurement equipment

Product No.	Manufacturer
4285A+42841A+42842C+42851-61100	Agilent Technologies

\* Equivalent measurement equipment may be used.

 Please be sure to request delivery specifications that provide further details on the features and specifications of the products for proper and safe use. Please note that the contents may change without any prior notice due to reasons such as upgrading.



# MLP2520 Type (H characteristic product, T dimension of the product 1.0mm max.)

## ELECTRICAL CHARACTERISTICS

### L FREQUENCY CHARACTERISTICS GRAPH

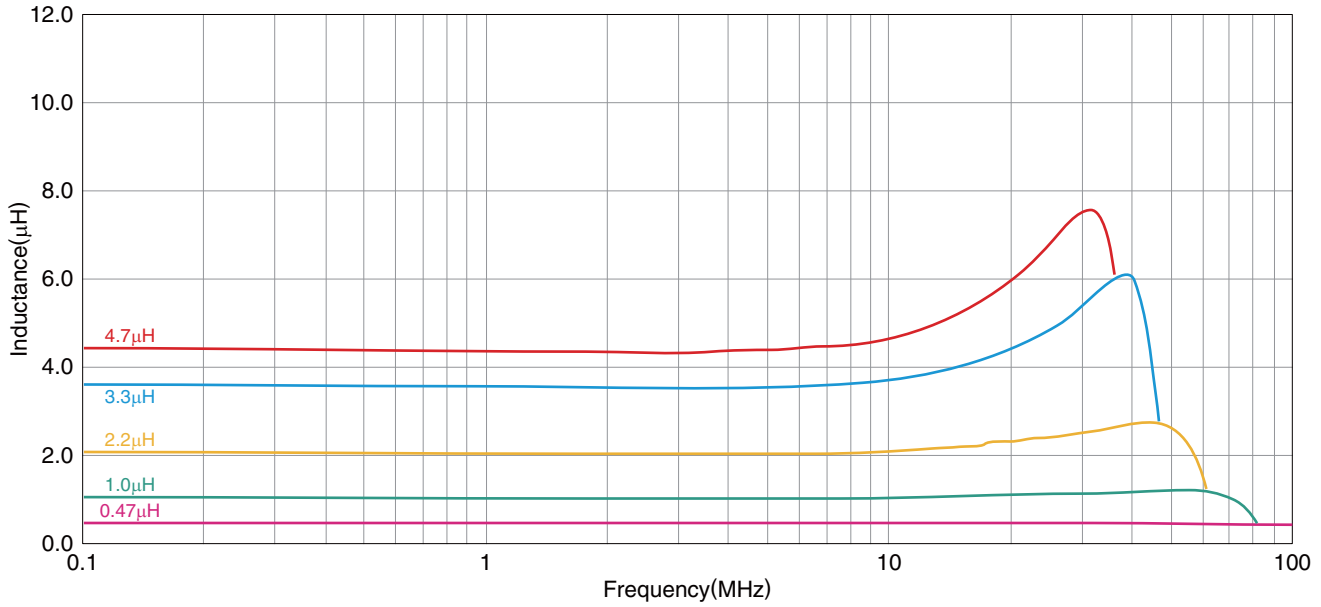

○ Measurement equipment

Product No.	Manufacturer
4294A+16034G	Agilent Technologies

\* Equivalent measurement equipment may be used.

# MLP2520 Type (H characteristic product, T dimension of the product 1.0mm max.)

## ELECTRICAL CHARACTERISTICS

### INDUCTANCE VS. DC BIAS CHARACTERISTICS GRAPH

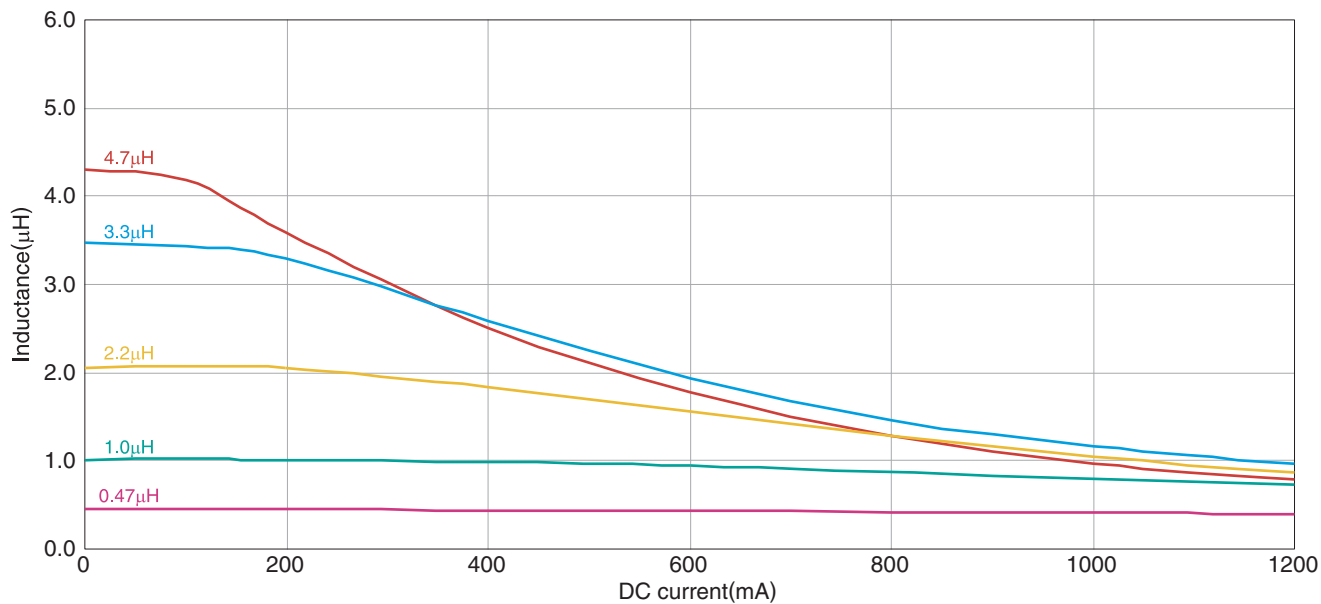

○ Measurement equipment

Product No.	Manufacturer
4285A+42841A+42842C+42851-61100	Agilent Technologies

\* Equivalent measurement equipment may be used.

 Please be sure to request delivery specifications that provide further details on the features and specifications of the products for proper and safe use. Please note that the contents may change without any prior notice due to reasons such as upgrading.

# MLP2520 Type (H characteristic product, T dimension of the product 1.2mm max.)

## ELECTRICAL CHARACTERISTICS

### L FREQUENCY CHARACTERISTICS GRAPH

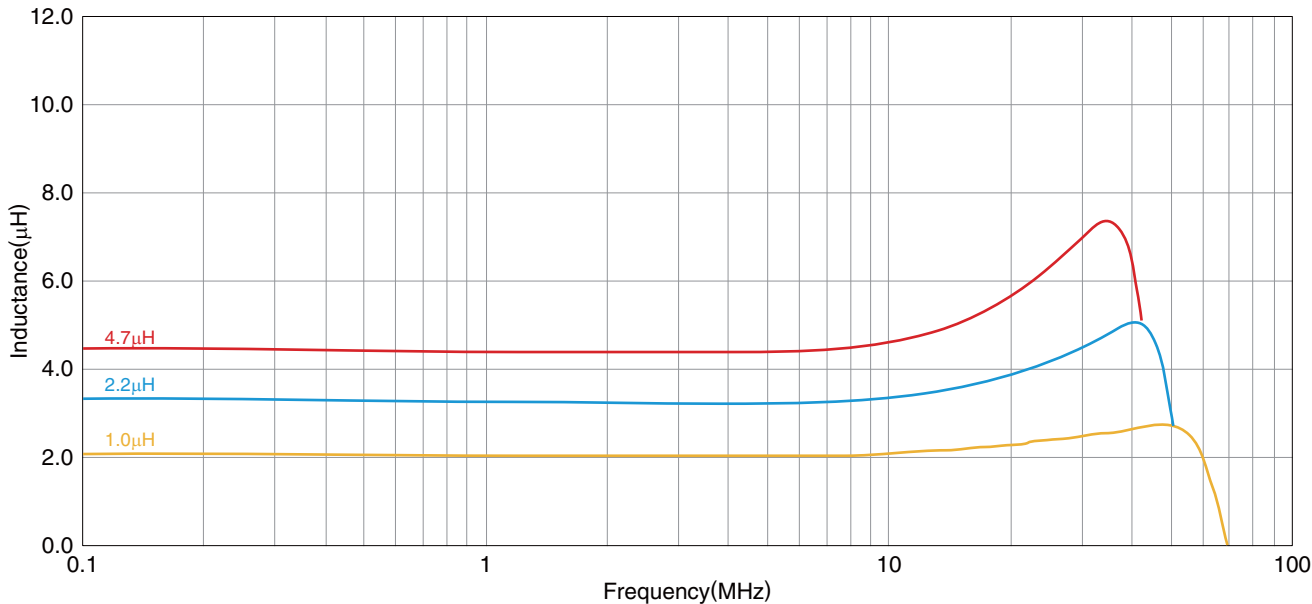

○ Measurement equipment

Product No.	Manufacturer
4294A+16034G	Agilent Technologies

\* Equivalent measurement equipment may be used.

# MLP2520 Type (H characteristic product, T dimension of the product 1.2mm max.)

## ELECTRICAL CHARACTERISTICS

### INDUCTANCE VS. DC BIAS CHARACTERISTICS GRAPH

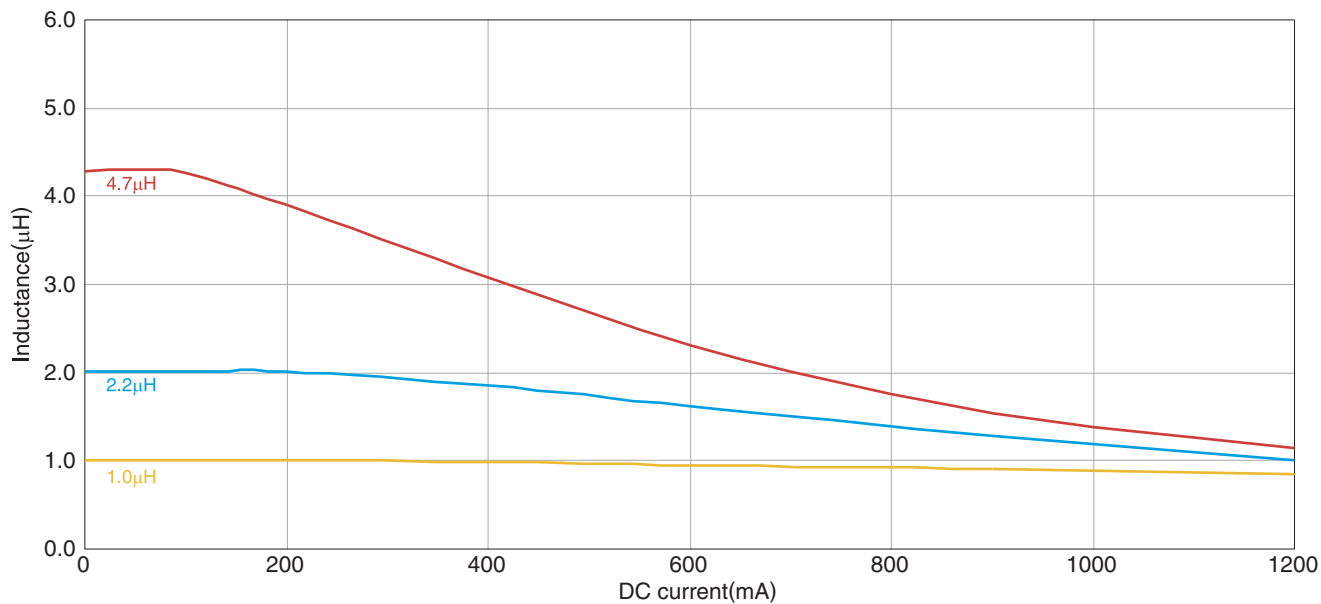

○ Measurement equipment

Product No.	Manufacturer
4285A+42841A+42842C+42851-61100	Agilent Technologies

\* Equivalent measurement equipment may be used.

 Please be sure to request delivery specifications that provide further details on the features and specifications of the products for proper and safe use. Please note that the contents may change without any prior notice due to reasons such as upgrading.

# MLP2520 Type (V characteristic product, T dimension of the product 1.0mm max.)

## ELECTRICAL CHARACTERISTICS

### L FREQUENCY CHARACTERISTICS GRAPH

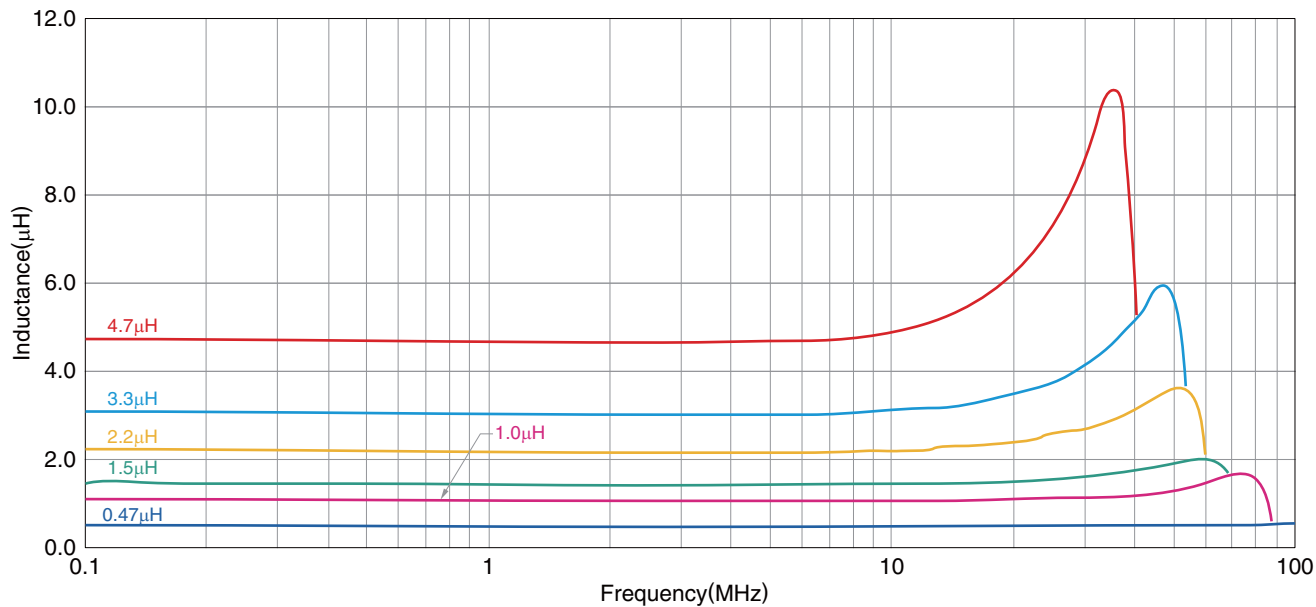

○ Measurement equipment

Product No.	Manufacturer
4294A+16034G	Agilent Technologies

\* Equivalent measurement equipment may be used.

 Please be sure to request delivery specifications that provide further details on the features and specifications of the products for proper and safe use. Please note that the contents may change without any prior notice due to reasons such as upgrading.

# MLP2520 Type (V characteristic product, T dimension of the product 1.0mm max.)

## ELECTRICAL CHARACTERISTICS

### INDUCTANCE VS. DC BIAS CHARACTERISTICS GRAPH

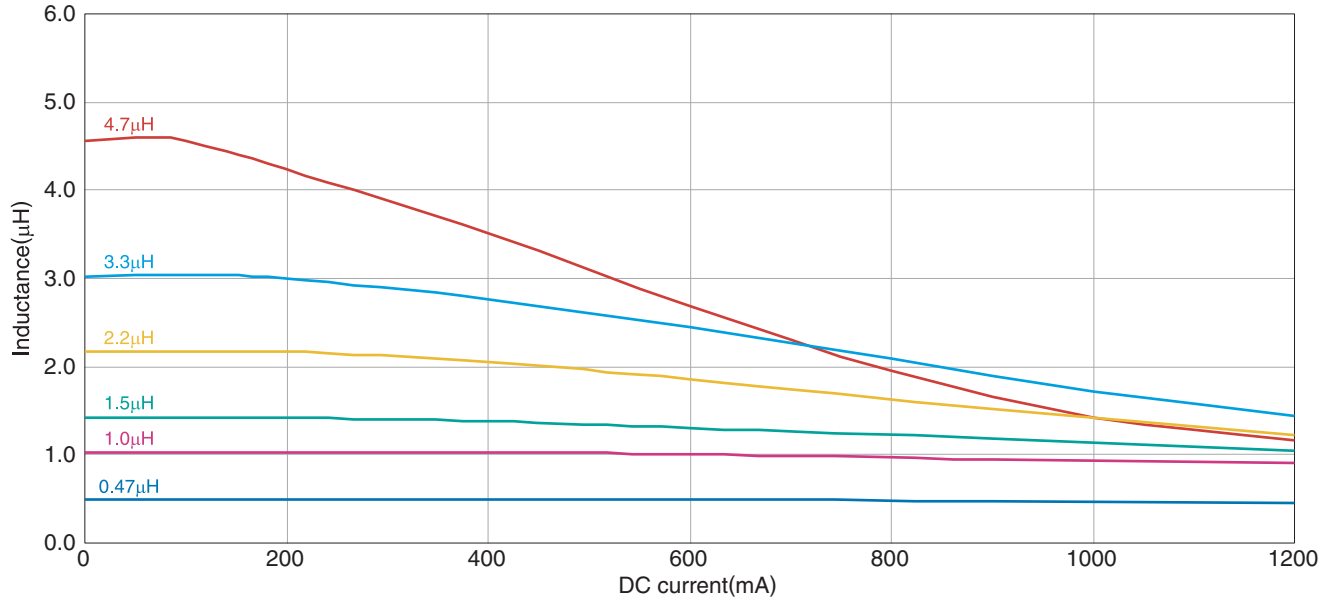

○ Measurement equipment

Product No.	Manufacturer
4285A+42841A+42842C+42851-61100	Agilent Technologies

\* Equivalent measurement equipment may be used.

# MLP2520 Type (V characteristic product, T dimension of the product 1.2mm max.)

## ELECTRICAL CHARACTERISTICS

### L FREQUENCY CHARACTERISTICS GRAPH

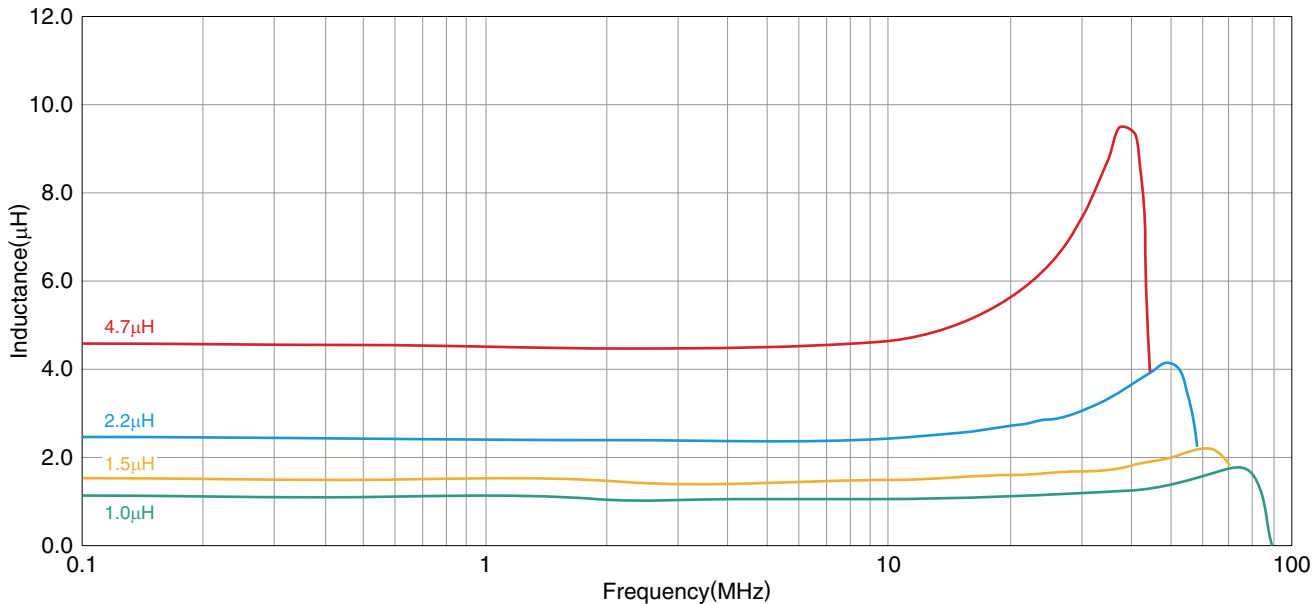

○ Measurement equipment

Product No.	Manufacturer
4294A+16034G	Agilent Technologies

\* Equivalent measurement equipment may be used.

# MLP2520 Type (V characteristic product, T dimension of the product 1.2mm max.)

## ELECTRICAL CHARACTERISTICS

### INDUCTANCE VS. DC BIAS CHARACTERISTICS GRAPH

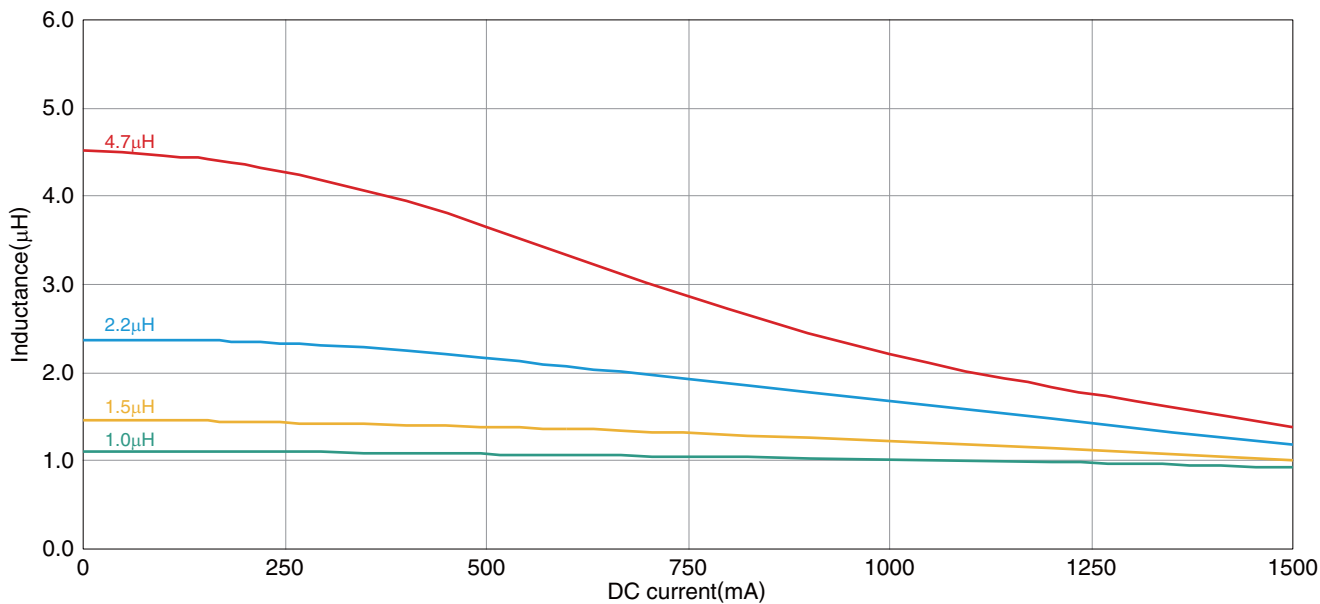

○ Measurement equipment

Product No.	Manufacturer
4285A+42841A+42842C+42851-61100	Agilent Technologies

\* Equivalent measurement equipment may be used.



# MLP2520 Type (S characteristic product, T dimension of the product 1.0mm max.)

## ELECTRICAL CHARACTERISTICS

### L FREQUENCY CHARACTERISTICS GRAPH

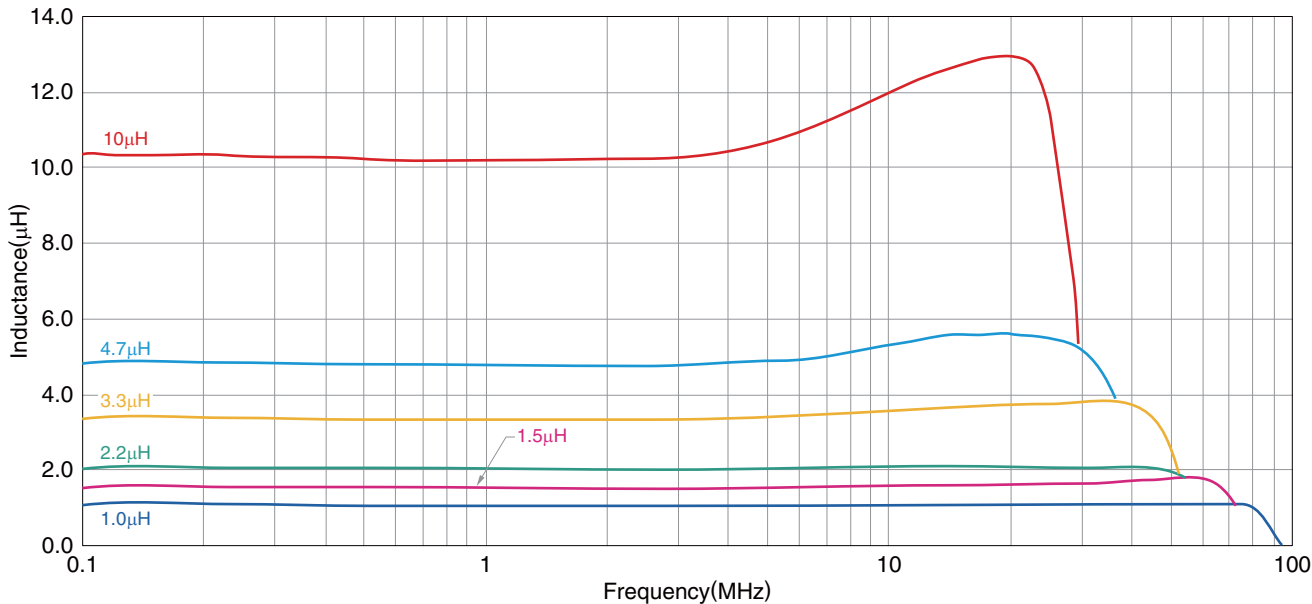

○ Measurement equipment

Product No.	Manufacturer
4294A+16034G	Agilent Technologies

\* Equivalent measurement equipment may be used.

# MLP2520 Type (S characteristic product, T dimension of the product 1.0mm max.)

## ELECTRICAL CHARACTERISTICS

### INDUCTANCE VS. DC BIAS CHARACTERISTICS GRAPH

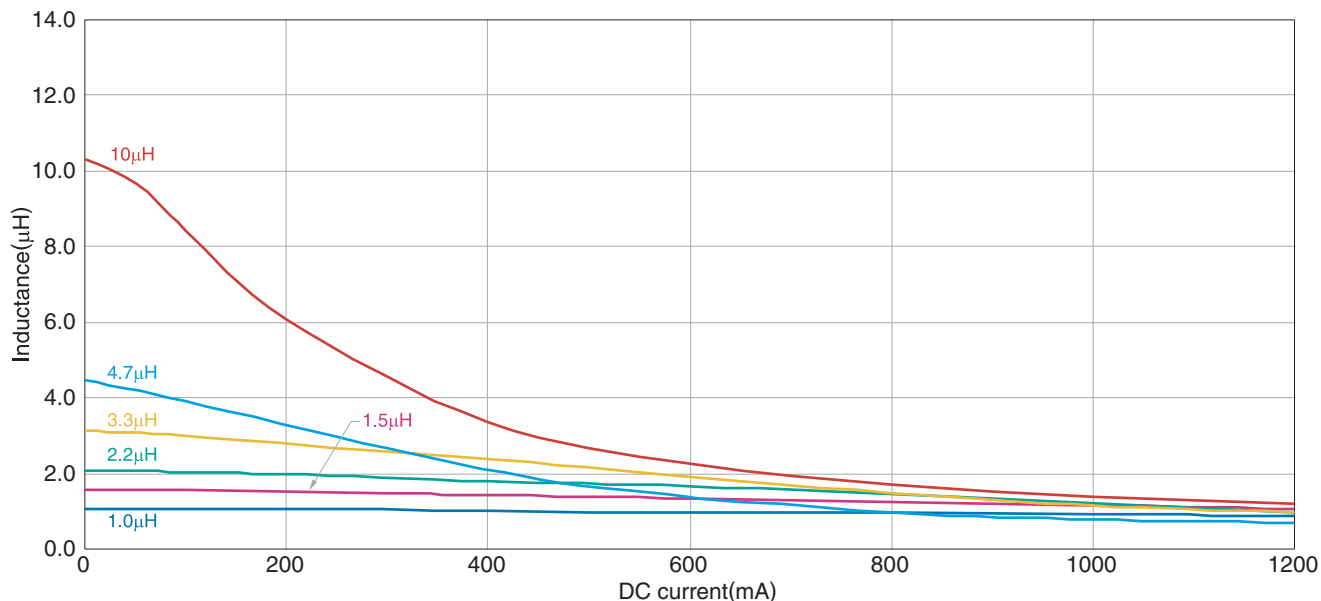

○ Measurement equipment

Product No.	Manufacturer
4285A+42841A+42842C+42851-61100	Agilent Technologies

\* Equivalent measurement equipment may be used.

 Please be sure to request delivery specifications that provide further details on the features and specifications of the products for proper and safe use. Please note that the contents may change without any prior notice due to reasons such as upgrading.

# MLP2520 Type (S characteristic product, T dimension of the product 1.2mm max.)

## ELECTRICAL CHARACTERISTICS

### L FREQUENCY CHARACTERISTICS GRAPH

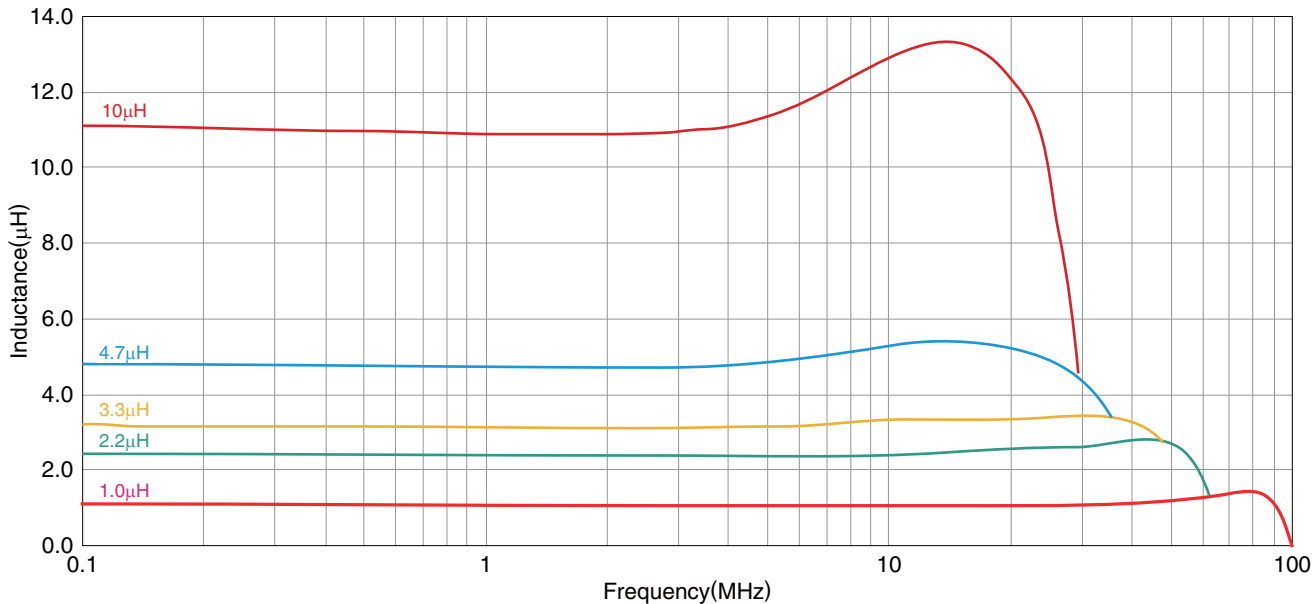

○ Measurement equipment

Product No.	Manufacturer
4294A+16034G	Agilent Technologies

\* Equivalent measurement equipment may be used.

 Please be sure to request delivery specifications that provide further details on the features and specifications of the products for proper and safe use. Please note that the contents may change without any prior notice due to reasons such as upgrading.

# MLP2520 Type (S characteristic product, T dimension of the product 1.2mm max.)

## ELECTRICAL CHARACTERISTICS

### INDUCTANCE VS. DC BIAS CHARACTERISTICS GRAPH

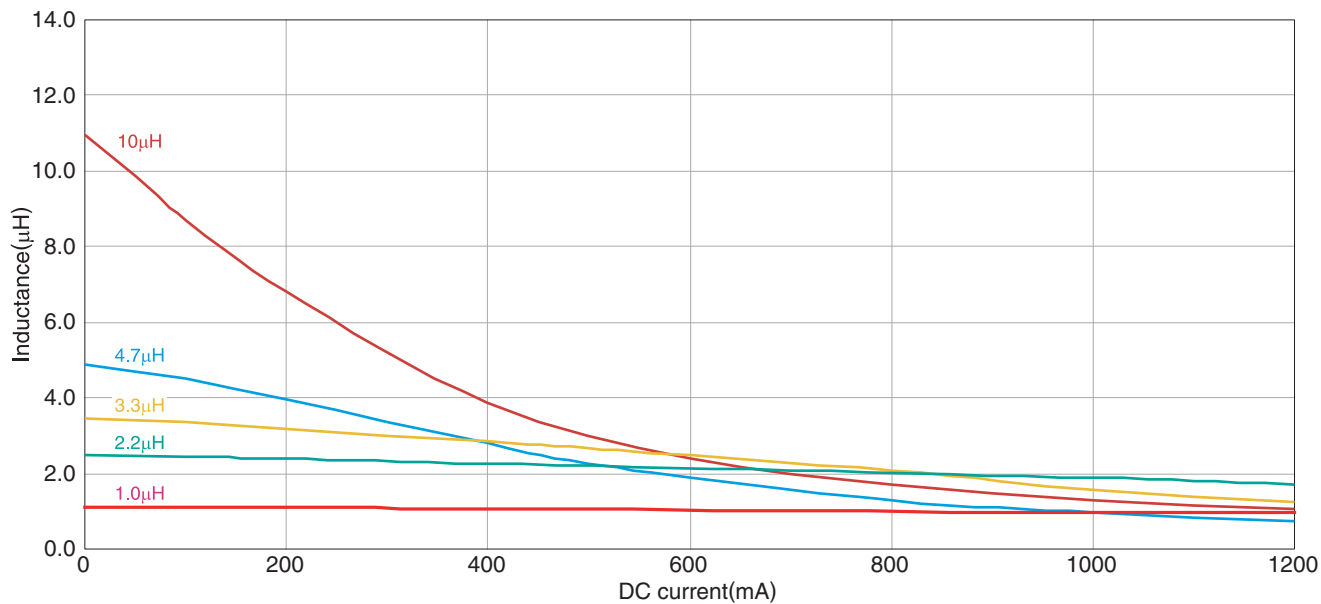

○ Measurement equipment

Product No.	Manufacturer
4285A+42841A+42842C+42851-61100	Agilent Technologies

\* Equivalent measurement equipment may be used.

 Please be sure to request delivery specifications that provide further details on the features and specifications of the products for proper and safe use. Please note that the contents may change without any prior notice due to reasons such as upgrading.

# MLP2520 Type

## PACKAGING STYLE

### REEL DIMENSIONS

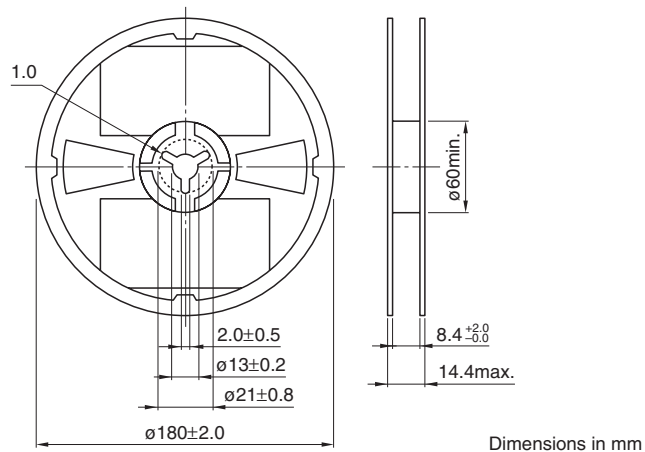

### TAPE DIMENSIONS

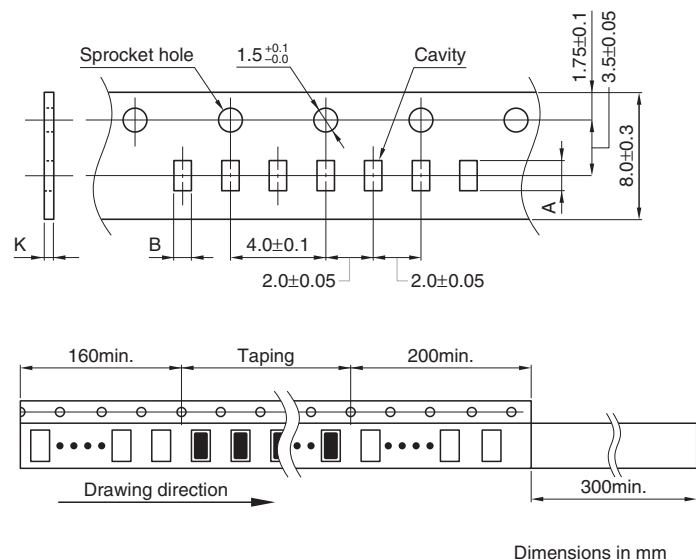

Type	A	B	K
MLP2520	2.7±0.1	2.3±0.2	1.5max.

 Please be sure to request delivery specifications that provide further details on the features and specifications of the products for proper and safe use. Please note that the contents may change without any prior notice due to reasons such as upgrading.