



# Inductors for high frequency circuits

Multilayer ceramic

**MHQ-PSA series**

# MHQ0402PSA<sub>type</sub>

---

MHQ0402PSA    0402 [01005 inch]\*

\* Dimensions code JIS[EIA]

---

## REMINDERS FOR USING THESE PRODUCTS

Before using these products, be sure to request the delivery specifications.

### SAFETY REMINDERS

Please pay sufficient attention to the warnings for safe designing when using this product.

#### REMINDERS

- The storage period is less than 12 months. Be sure to follow the storage conditions (temperature: 5 to 40°C, humidity: 10 to 75% RH or less).  
If the storage period elapses, the soldering of the terminal electrodes may deteriorate.
- Do not use or store in locations where there are conditions such as gas corrosion (salt, acid, alkali, etc.).
- Before soldering, be sure to preheat components.  
The preheating temperature should be set so that the temperature difference between the solder temperature and chip temperature does not exceed 150°C.
- Soldering corrections after mounting should be within the range of the conditions determined in the specifications.  
If overheated, a short circuit, performance deterioration, or lifespan shortening may occur.
- When embedding a printed circuit board where a chip is mounted to a set, be sure that residual stress is not given to the chip due to the overall distortion of the printed circuit board and partial distortion such as at screw tightening portions.
- Self heating (temperature increase) occurs when the power is turned ON, so the tolerance should be sufficient for the set thermal design.
- Carefully lay out the coil for the circuit board design of the non-magnetic shield type.  
A malfunction may occur due to magnetic interference.
- Use a wrist band to discharge static electricity in your body through the grounding wire.
- Do not expose the products to magnets or magnetic fields.
- Do not use for a purpose outside of the contents regulated in the delivery specifications.
- The products listed on this catalog are intended for use in general electronic equipment (AV equipment, telecommunications equipment, home appliances, amusement equipment, computer equipment, personal equipment, office equipment, measurement equipment, industrial robots) under a normal operation and use condition.  
The products are not designed or warranted to meet the requirements of the applications listed below, whose performance and/or quality require a more stringent level of safety or reliability, or whose failure, malfunction or trouble could cause serious damage to society, person or property.  
If you intend to use the products in the applications listed below or if you have special requirements exceeding the range or conditions set forth in the each catalog, please contact us.

- (1) Aerospace/aviation equipment
- (2) Transportation equipment (cars, electric trains, ships, etc.)
- (3) Medical equipment
- (4) Power-generation control equipment
- (5) Atomic energy-related equipment
- (6) Seabed equipment
- (7) Transportation control equipment

- (8) Public information-processing equipment
- (9) Military equipment
- (10) Electric heating apparatus, burning equipment
- (11) Disaster prevention/crime prevention equipment
- (12) Safety equipment
- (13) Other applications that are not considered general-purpose applications

When designing your equipment even for general-purpose applications, you are kindly requested to take into consideration securing protection circuit/device or providing backup circuits in your equipment.

# Inductors for high frequency circuits

## Multilayer ceramic

Product compatible with RoHS directive  
Halogen-free  
Compatible with lead-free solders

# Overview of MHQ0402PSA series

## FEATURES

- Unique ceramic material and configuration allows for the realization of high Q characteristics.
- Multilayer method allows for a lineup with fine increments of inductance.

## APPLICATION

Smart phones, tablet terminals, high frequency modules (PAs, VCOs, FEMs , etc.), Bluetooth, W-LAN, UWB, tuners and other high frequency circuits for the mobile communication industry

## PART NUMBER CONSTRUCTION

MHQ	0402	PSA	0N2	B	T	000		
Series name	LxWxH dimensions (mm)		Inductance (nH)		Inductance tolerance		Packaging style	Internal code
	0402	0.4x0.2x0.2	PSA		B ±0.1nH		T	Taping
			0N6	0.6	C	±0.2nH		000
			1N1	1.1	S	±0.3nH		
			11N	11	H	±3%		
					J	±5%		

## OPERATING TEMPERATURE RANGE, PACKAGE QUANTITY, PRODUCT WEIGHT

Type	Temperature ranges		Package quantity (pieces/reel)	Individual weight (mg)
	Operating temperature (°C)	Storage temperature* (°C)		
MHQ0402PSA	-55 to +125	-55 to +125	20000	0.07

\* The storage temperature range is for after the circuit board is mounted.

- RoHS Directive Compliant Product: See the following for more details. <https://product.tdk.com/info/en/environment/rohs/index.html>
- Halogen-free: indicates that Cl content is less than 900ppm, Br content is less than 900ppm, and that the total Cl and Br content is less than 1500ppm.

 Please be sure to request delivery specifications that provide further details on the features and specifications of the products for proper and safe use. Please note that the contents may change without any prior notice due to reasons such as upgrading.

# MHQ0402PSA type

## RECOMMENDED REFLOW PROFILE



Preheating			Soldering		Peak	
Temp.		Time	Temp.	Time	Temp.	Time
T1	T2	t1	T3	t2	T4	t3
150°C	180°C	60 to 120s	230°C	30 to 60s	250 to 260°C	10s max.

# MHQ0402PSA type

## SHAPE & DIMENSIONS

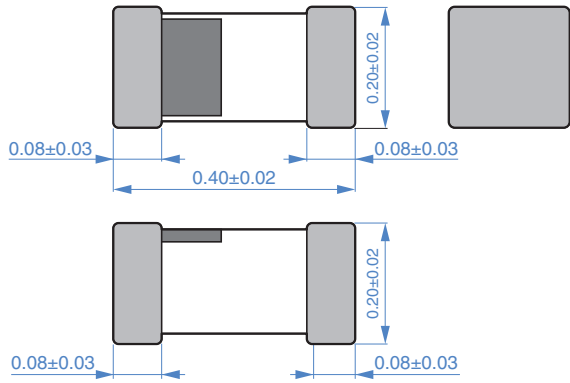

Dimensions in mm

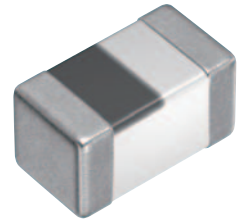

## RECOMMENDED LAND PATTERN

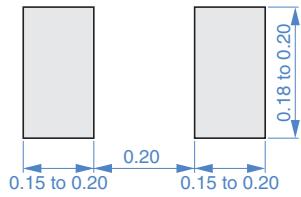

Dimensions in mm

Please be sure to request delivery specifications that provide further details on the features and specifications of the products for proper and safe use. Please note that the contents may change without any prior notice due to reasons such as upgrading.

# MHQ0402PSA type

## ELECTRICAL CHARACTERISTICS

### CHARACTERISTICS SPECIFICATION TABLE

L	L tolerance	L measuring frequency (MHz)	Q min.	Q measuring frequency (MHz)	Self-resonant frequency		DC resistance		Rated current (mA)max.	Part No.
					(GHz)min.	(GHz)typ.	( $\Omega$ )max.	( $\Omega$ )typ.		
0.2	$\pm 0.1$ nH	500	—	500	10	20.00	0.15	0.02	600	MHQ0402PSA0N2BT000
0.2	$\pm 0.2$ nH	500	—	500	10	20.00	0.15	0.02	600	MHQ0402PSA0N2CT000
0.3	$\pm 0.1$ nH	500	—	500	10	20.00	0.15	0.04	600	MHQ0402PSA0N3BT000
0.3	$\pm 0.2$ nH	500	—	500	10	20.00	0.15	0.04	600	MHQ0402PSA0N3CT000
0.4	$\pm 0.1$ nH	500	—	500	10	20.00	0.15	0.04	600	MHQ0402PSA0N4BT000
0.4	$\pm 0.2$ nH	500	—	500	10	20.00	0.15	0.04	600	MHQ0402PSA0N4CT000
0.4	$\pm 0.3$ nH	500	—	500	10	20.00	0.15	0.04	600	MHQ0402PSA0N4ST000
0.5	$\pm 0.1$ nH	500	—	500	10	20.00	0.15	0.04	600	MHQ0402PSA0N5BT000
0.5	$\pm 0.2$ nH	500	—	500	10	20.00	0.15	0.04	600	MHQ0402PSA0N5CT000
0.5	$\pm 0.3$ nH	500	—	500	10	20.00	0.15	0.04	600	MHQ0402PSA0N5ST000
0.6	$\pm 0.1$ nH	500	—	500	10	20.00	0.15	0.05	600	MHQ0402PSA0N6BT000
0.6	$\pm 0.2$ nH	500	—	500	10	20.00	0.15	0.05	600	MHQ0402PSA0N6CT000
0.6	$\pm 0.3$ nH	500	—	500	10	20.00	0.15	0.05	600	MHQ0402PSA0N6ST000
0.7	$\pm 0.1$ nH	500	—	500	10	20.00	0.15	0.06	600	MHQ0402PSA0N7BT000
0.7	$\pm 0.2$ nH	500	—	500	10	20.00	0.15	0.06	600	MHQ0402PSA0N7CT000
0.7	$\pm 0.3$ nH	500	—	500	10	20.00	0.15	0.06	600	MHQ0402PSA0N7ST000
0.8	$\pm 0.1$ nH	500	—	500	10	20.00	0.15	0.06	600	MHQ0402PSA0N8BT000
0.8	$\pm 0.2$ nH	500	—	500	10	20.00	0.15	0.06	600	MHQ0402PSA0N8CT000
0.8	$\pm 0.3$ nH	500	—	500	10	20.00	0.15	0.06	600	MHQ0402PSA0N8ST000
0.9	$\pm 0.1$ nH	500	—	500	10	20.00	0.15	0.08	600	MHQ0402PSA0N9BT000
0.9	$\pm 0.2$ nH	500	—	500	10	20.00	0.15	0.08	600	MHQ0402PSA0N9CT000
0.9	$\pm 0.3$ nH	500	—	500	10	20.00	0.15	0.08	600	MHQ0402PSA0N9ST000
1.0	$\pm 0.1$ nH	500	10	500	10	18.84	0.15	0.07	600	MHQ0402PSA1N0BT000
1.0	$\pm 0.2$ nH	500	10	500	10	18.84	0.15	0.07	600	MHQ0402PSA1N0CT000
1.0	$\pm 0.3$ nH	500	10	500	10	18.84	0.15	0.07	600	MHQ0402PSA1N0ST000
1.1	$\pm 0.1$ nH	500	10	500	10	20.00	0.15	0.11	500	MHQ0402PSA1N1BT000
1.1	$\pm 0.2$ nH	500	10	500	10	20.00	0.15	0.11	500	MHQ0402PSA1N1CT000
1.1	$\pm 0.3$ nH	500	10	500	10	20.00	0.15	0.11	500	MHQ0402PSA1N1ST000
1.2	$\pm 0.1$ nH	500	10	500	10	16.72	0.20	0.15	500	MHQ0402PSA1N2BT000
1.2	$\pm 0.2$ nH	500	10	500	10	16.72	0.20	0.15	500	MHQ0402PSA1N2CT000
1.2	$\pm 0.3$ nH	500	10	500	10	16.72	0.20	0.15	500	MHQ0402PSA1N2ST000
1.3	$\pm 0.1$ nH	500	10	500	10	16.61	0.20	0.13	400	MHQ0402PSA1N3BT000
1.3	$\pm 0.2$ nH	500	10	500	10	16.61	0.20	0.13	400	MHQ0402PSA1N3CT000
1.3	$\pm 0.3$ nH	500	10	500	10	16.61	0.20	0.13	400	MHQ0402PSA1N3ST000
1.4	$\pm 0.1$ nH	500	10	500	10	16.22	0.30	0.18	400	MHQ0402PSA1N4BT000
1.4	$\pm 0.2$ nH	500	10	500	10	16.22	0.30	0.18	400	MHQ0402PSA1N4CT000
1.4	$\pm 0.3$ nH	500	10	500	10	16.22	0.30	0.18	400	MHQ0402PSA1N4ST000
1.5	$\pm 0.1$ nH	500	10	500	10	14.74	0.20	0.15	400	MHQ0402PSA1N5BT000
1.5	$\pm 0.2$ nH	500	10	500	10	14.74	0.20	0.15	400	MHQ0402PSA1N5CT000
1.5	$\pm 0.3$ nH	500	10	500	10	14.74	0.20	0.15	400	MHQ0402PSA1N5ST000

• Short bar residual inductance =0.11nH

#### Measurement equipment

Measurement item	Product No.	Manufacturer
L, Q	4991A+16196D	Keysight Technologies
Self-resonant frequency	8720C	Keysight Technologies
DC resistance	4338A	Yokogawa

\* Equivalent measurement equipment may be used.

# MHQ0402PSA type

## ELECTRICAL CHARACTERISTICS

### CHARACTERISTICS SPECIFICATION TABLE

L (nH)	Tolerance	L measuring	Q	Q measuring	Self-resonant		DC resistance		Rated current	Part No.
		frequency (MHz)	min.	frequency (MHz)	frequency (GHz)min.	frequency (GHz)typ.	( $\Omega$ )max.	( $\Omega$ )typ.	(mA)max.	
1.6	$\pm 0.1$ nH	500	10	500	10	15.27	0.30	0.15	400	MHQ0402PSA1N6BT000
1.6	$\pm 0.2$ nH	500	10	500	10	15.27	0.30	0.15	400	MHQ0402PSA1N6CT000
1.6	$\pm 0.3$ nH	500	10	500	10	15.27	0.30	0.15	400	MHQ0402PSA1N6ST000
1.7	$\pm 0.1$ nH	500	10	500	10	14.22	0.40	0.21	400	MHQ0402PSA1N7BT000
1.7	$\pm 0.2$ nH	500	10	500	10	14.22	0.40	0.21	400	MHQ0402PSA1N7CT000
1.7	$\pm 0.3$ nH	500	10	500	10	14.22	0.40	0.21	400	MHQ0402PSA1N7ST000
1.8	$\pm 0.1$ nH	500	10	500	8	12.32	0.40	0.14	400	MHQ0402PSA1N8BT000
1.8	$\pm 0.2$ nH	500	10	500	8	12.32	0.40	0.14	400	MHQ0402PSA1N8CT000
1.8	$\pm 0.3$ nH	500	10	500	8	12.32	0.40	0.14	400	MHQ0402PSA1N8ST000
1.9	$\pm 0.1$ nH	500	10	500	8	12.69	0.40	0.14	400	MHQ0402PSA1N9BT000
1.9	$\pm 0.2$ nH	500	10	500	8	12.69	0.40	0.14	400	MHQ0402PSA1N9CT000
1.9	$\pm 0.3$ nH	500	10	500	8	12.69	0.40	0.14	400	MHQ0402PSA1N9ST000
2.0	$\pm 0.1$ nH	500	10	500	8	12.76	0.40	0.17	400	MHQ0402PSA2N0BT000
2.0	$\pm 0.2$ nH	500	10	500	8	12.76	0.40	0.17	400	MHQ0402PSA2N0CT000
2.0	$\pm 0.3$ nH	500	10	500	8	12.76	0.40	0.17	400	MHQ0402PSA2N0ST000
2.1	$\pm 0.1$ nH	500	10	500	8	12.32	0.40	0.23	400	MHQ0402PSA2N1BT000
2.1	$\pm 0.2$ nH	500	10	500	8	12.32	0.40	0.23	400	MHQ0402PSA2N1CT000
2.1	$\pm 0.3$ nH	500	10	500	8	12.32	0.40	0.23	400	MHQ0402PSA2N1ST000
2.2	$\pm 0.1$ nH	500	10	500	8	10.66	0.40	0.16	400	MHQ0402PSA2N2BT000
2.2	$\pm 0.2$ nH	500	10	500	8	10.66	0.40	0.16	400	MHQ0402PSA2N2CT000
2.2	$\pm 0.3$ nH	500	10	500	8	10.66	0.40	0.16	400	MHQ0402PSA2N2ST000
2.3	$\pm 0.1$ nH	500	10	500	8	11.33	0.40	0.23	300	MHQ0402PSA2N3BT000
2.3	$\pm 0.2$ nH	500	10	500	8	11.33	0.40	0.23	300	MHQ0402PSA2N3CT000
2.3	$\pm 0.3$ nH	500	10	500	8	11.33	0.40	0.23	300	MHQ0402PSA2N3ST000
2.4	$\pm 0.1$ nH	500	10	500	8	11.53	0.40	0.25	300	MHQ0402PSA2N4BT000
2.4	$\pm 0.2$ nH	500	10	500	8	11.53	0.40	0.25	300	MHQ0402PSA2N4CT000
2.4	$\pm 0.3$ nH	500	10	500	8	11.53	0.40	0.25	300	MHQ0402PSA2N4ST000
2.5	$\pm 0.1$ nH	500	10	500	8	10.92	0.40	0.23	300	MHQ0402PSA2N5BT000
2.5	$\pm 0.2$ nH	500	10	500	8	10.92	0.40	0.23	300	MHQ0402PSA2N5CT000
2.5	$\pm 0.3$ nH	500	10	500	8	10.92	0.40	0.23	300	MHQ0402PSA2N5ST000
2.6	$\pm 0.1$ nH	500	10	500	8	10.60	0.40	0.22	300	MHQ0402PSA2N6BT000
2.6	$\pm 0.2$ nH	500	10	500	8	10.60	0.40	0.22	300	MHQ0402PSA2N6CT000
2.6	$\pm 0.3$ nH	500	10	500	8	10.60	0.40	0.22	300	MHQ0402PSA2N6ST000
2.7	$\pm 0.1$ nH	500	10	500	8	10.73	0.40	0.24	300	MHQ0402PSA2N7BT000
2.7	$\pm 0.2$ nH	500	10	500	8	10.73	0.40	0.24	300	MHQ0402PSA2N7CT000
2.7	$\pm 0.3$ nH	500	10	500	8	10.73	0.40	0.24	300	MHQ0402PSA2N7ST000
2.8	$\pm 0.1$ nH	500	10	500	8	10.41	0.40	0.23	250	MHQ0402PSA2N8BT000
2.8	$\pm 0.2$ nH	500	10	500	8	10.41	0.40	0.23	250	MHQ0402PSA2N8CT000
2.8	$\pm 0.3$ nH	500	10	500	8	10.41	0.40	0.23	250	MHQ0402PSA2N8ST000
2.9	$\pm 0.1$ nH	500	10	500	8	10.49	0.60	0.32	250	MHQ0402PSA2N9BT000
2.9	$\pm 0.2$ nH	500	10	500	8	10.49	0.60	0.32	250	MHQ0402PSA2N9CT000
2.9	$\pm 0.3$ nH	500	10	500	8	10.49	0.60	0.32	250	MHQ0402PSA2N9ST000

· Short bar residual inductance =0.11nH

#### ○ Measurement equipment

Measurement item	Product No.	Manufacturer
L, Q	4991A+16196D	Keysight Technologies
Self-resonant frequency	8720C	Keysight Technologies
DC resistance	4338A	Yokogawa

\* Equivalent measurement equipment may be used.

# MHQ0402PSA type

## ELECTRICAL CHARACTERISTICS

### CHARACTERISTICS SPECIFICATION TABLE

L (nH)	L tolerance	L measuring	Q	Q measuring	Self-resonant		DC resistance		Rated current	Part No.
		frequency (MHz)	min.	frequency (MHz)	frequency (GHz)min.	frequency (GHz)typ.	( $\Omega$ )max.	( $\Omega$ )typ.	(mA)max.	
3.0	$\pm 0.1$ nH	500	10	500	7	10.22	0.60	0.28	250	MHQ0402PSA3N0BT000
3.0	$\pm 0.2$ nH	500	10	500	7	10.22	0.60	0.28	250	MHQ0402PSA3N0CT000
3.0	$\pm 0.3$ nH	500	10	500	7	10.22	0.60	0.28	250	MHQ0402PSA3N0ST000
3.1	$\pm 0.1$ nH	500	10	500	7	10.17	0.65	0.34	250	MHQ0402PSA3N1BT000
3.1	$\pm 0.2$ nH	500	10	500	7	10.17	0.65	0.34	250	MHQ0402PSA3N1CT000
3.1	$\pm 0.3$ nH	500	10	500	7	10.17	0.65	0.34	250	MHQ0402PSA3N1ST000
3.2	$\pm 0.1$ nH	500	10	500	7	9.99	0.65	0.33	250	MHQ0402PSA3N2BT000
3.2	$\pm 0.2$ nH	500	10	500	7	9.99	0.65	0.33	250	MHQ0402PSA3N2CT000
3.2	$\pm 0.3$ nH	500	10	500	7	9.99	0.65	0.33	250	MHQ0402PSA3N2ST000
3.3	$\pm 0.1$ nH	500	10	500	7	9.46	0.65	0.30	250	MHQ0402PSA3N3BT000
3.3	$\pm 0.2$ nH	500	10	500	7	9.46	0.65	0.30	250	MHQ0402PSA3N3CT000
3.3	$\pm 0.3$ nH	500	10	500	7	9.46	0.65	0.30	250	MHQ0402PSA3N3ST000
3.4	$\pm 0.1$ nH	500	10	500	6	8.91	0.65	0.22	200	MHQ0402PSA3N4BT000
3.4	$\pm 0.2$ nH	500	10	500	6	8.91	0.65	0.22	200	MHQ0402PSA3N4CT000
3.4	$\pm 0.3$ nH	500	10	500	6	8.91	0.65	0.22	200	MHQ0402PSA3N4ST000
3.5	$\pm 0.1$ nH	500	10	500	6	9.18	0.65	0.27	200	MHQ0402PSA3N5BT000
3.5	$\pm 0.2$ nH	500	10	500	6	9.18	0.65	0.27	200	MHQ0402PSA3N5CT000
3.5	$\pm 0.3$ nH	500	10	500	6	9.18	0.65	0.27	200	MHQ0402PSA3N5ST000
3.6	$\pm 0.1$ nH	500	10	500	6	8.85	0.65	0.29	200	MHQ0402PSA3N6BT000
3.6	$\pm 0.2$ nH	500	10	500	6	8.85	0.65	0.29	200	MHQ0402PSA3N6CT000
3.6	$\pm 0.3$ nH	500	10	500	6	8.85	0.65	0.29	200	MHQ0402PSA3N6ST000
3.7	$\pm 0.1$ nH	500	10	500	6	9.07	0.75	0.31	200	MHQ0402PSA3N7BT000
3.7	$\pm 0.2$ nH	500	10	500	6	9.07	0.75	0.31	200	MHQ0402PSA3N7CT000
3.7	$\pm 0.3$ nH	500	10	500	6	9.07	0.75	0.31	200	MHQ0402PSA3N7ST000
3.8	$\pm 0.1$ nH	500	10	500	6	9.02	0.75	0.31	200	MHQ0402PSA3N8BT000
3.8	$\pm 0.2$ nH	500	10	500	6	9.02	0.75	0.31	200	MHQ0402PSA3N8CT000
3.8	$\pm 0.3$ nH	500	10	500	6	9.02	0.75	0.31	200	MHQ0402PSA3N8ST000
3.9	$\pm 0.1$ nH	500	10	500	6	8.91	0.75	0.32	200	MHQ0402PSA3N9BT000
3.9	$\pm 0.2$ nH	500	10	500	6	8.91	0.75	0.32	200	MHQ0402PSA3N9CT000
3.9	$\pm 0.3$ nH	500	10	500	6	8.91	0.75	0.32	200	MHQ0402PSA3N9ST000
4.0	$\pm 0.1$ nH	500	10	500	6	8.80	0.80	0.40	200	MHQ0402PSA4N0BT000
4.0	$\pm 0.2$ nH	500	10	500	6	8.80	0.80	0.40	200	MHQ0402PSA4N0CT000
4.0	$\pm 0.3$ nH	500	10	500	6	8.80	0.80	0.40	200	MHQ0402PSA4N0ST000
4.1	$\pm 0.1$ nH	500	10	500	6	8.65	0.80	0.40	200	MHQ0402PSA4N1BT000
4.1	$\pm 0.2$ nH	500	10	500	6	8.65	0.80	0.40	200	MHQ0402PSA4N1CT000
4.1	$\pm 0.3$ nH	500	10	500	6	8.65	0.80	0.40	200	MHQ0402PSA4N1ST000
4.2	$\pm 0.1$ nH	500	10	500	6	8.60	0.80	0.40	200	MHQ0402PSA4N2BT000
4.2	$\pm 0.2$ nH	500	10	500	6	8.60	0.80	0.40	200	MHQ0402PSA4N2CT000
4.2	$\pm 0.3$ nH	500	10	500	6	8.60	0.80	0.40	200	MHQ0402PSA4N2ST000
4.3	$\pm 3\%$	500	10	500	6	8.14	0.80	0.40	200	MHQ0402PSA4N3HT000
4.3	$\pm 5\%$	500	10	500	6	8.14	0.80	0.40	200	MHQ0402PSA4N3JT000
4.7	$\pm 3\%$	500	10	500	5	8.14	0.80	0.38	200	MHQ0402PSA4N7HT000
4.7	$\pm 5\%$	500	10	500	5	8.14	0.80	0.38	200	MHQ0402PSA4N7JT000

• Short bar residual inductance =0.11nH

#### Measurement equipment

Measurement item	Product No.	Manufacturer
L、Q	4991A+16196D	Keysight Technologies
Self-resonant frequency	8720C	Keysight Technologies
DC resistance	4338A	Yokogawa

\* Equivalent measurement equipment may be used.



# MHQ0402PSA type

## ELECTRICAL CHARACTERISTICS

### CHARACTERISTICS SPECIFICATION TABLE

L (nH)	Tolerance	L measuring	Q	Q measuring	Self-resonant		DC resistance		Rated current	Part No.
		frequency (MHz)	min.	frequency (MHz)	frequency (GHz)min.	frequency (GHz)typ.	( $\Omega$ )max.	( $\Omega$ )typ.	(mA)max.	
5.1	±3%	500	10	500	5	7.76	0.80	0.47	200	MHQ0402PSA5N1HT000
5.1	±5%	500	10	500	5	7.76	0.80	0.47	200	MHQ0402PSA5N1JT000
5.6	±3%	500	10	500	5	7.49	0.80	0.44	200	MHQ0402PSA5N6HT000
5.6	±5%	500	10	500	5	7.49	0.80	0.44	200	MHQ0402PSA5N6JT000
6.2	±3%	500	10	500	5	6.89	1.00	0.58	200	MHQ0402PSA6N2HT000
6.2	±5%	500	10	500	5	6.89	1.00	0.58	200	MHQ0402PSA6N2JT000
6.8	±3%	500	10	500	5	6.93	1.00	0.60	200	MHQ0402PSA6N8HT000
6.8	±5%	500	10	500	5	6.93	1.00	0.60	200	MHQ0402PSA6N8JT000
7.5	±3%	500	10	500	4	6.29	1.20	0.66	180	MHQ0402PSA7N5HT000
7.5	±5%	500	10	500	4	6.29	1.20	0.66	180	MHQ0402PSA7N5JT000
8.2	±3%	500	10	500	4	6.14	1.20	0.66	180	MHQ0402PSA8N2HT000
8.2	±5%	500	10	500	4	6.14	1.20	0.66	180	MHQ0402PSA8N2JT000
9.1	±3%	500	8	500	3.5	5.5	1.50	1.15	130	MHQ0402PSA9N1HT000
9.1	±5%	500	8	500	3.5	5.5	1.50	1.15	130	MHQ0402PSA9N1JT000
10.0	±3%	500	8	500	3.5	5.1	1.60	1.35	130	MHQ0402PSA10NHT000
10.0	±5%	500	8	500	3.5	5.1	1.60	1.35	130	MHQ0402PSA10NJT000
11.0	±3%	500	8	500	3.0	5.0	1.70	1.28	130	MHQ0402PSA11NHT000
11.0	±5%	500	8	500	3.0	5.0	1.70	1.28	130	MHQ0402PSA11NJT000
12.0	±3%	500	8	500	2.7	4.8	1.90	1.35	130	MHQ0402PSA12NHT000
12.0	±5%	500	8	500	2.7	4.8	1.90	1.35	130	MHQ0402PSA12NJT000
13.0	±3%	500	8	500	2.7	4.4	2.00	1.53	120	MHQ0402PSA13NHT000
13.0	±5%	500	8	500	2.7	4.4	2.00	1.53	120	MHQ0402PSA13NJT000
15.0	±3%	500	8	500	2.7	3.8	2.10	1.68	120	MHQ0402PSA15NHT000
15.0	±5%	500	8	500	2.7	3.8	2.10	1.68	120	MHQ0402PSA15NJT000
16.0	±3%	500	8	500	2.5	3.8	2.10	1.70	120	MHQ0402PSA16NHT000
16.0	±5%	500	8	500	2.5	3.8	2.10	1.70	120	MHQ0402PSA16NJT000
18.0	±3%	500	8	500	2.5	3.8	2.20	1.82	110	MHQ0402PSA18NHT000
18.0	±5%	500	8	500	2.5	3.8	2.20	1.82	110	MHQ0402PSA18NJT000
20.0	±3%	500	8	500	2.4	3.5	2.40	1.91	110	MHQ0402PSA20NHT000
20.0	±5%	500	8	500	2.4	3.5	2.40	1.91	110	MHQ0402PSA20NJT000
22.0	±3%	500	8	500	2.3	3.6	2.50	1.97	110	MHQ0402PSA22NHT000
22.0	±5%	500	8	500	2.3	3.6	2.50	1.97	110	MHQ0402PSA22NJT000

· Short bar residual inductance =0.11nH

#### Measurement equipment

Measurement item	Product No.	Manufacturer
L, Q	4991A+16196D	Keysight Technologies
Self-resonant frequency	8720C	Keysight Technologies
DC resistance	4338A	Yokogawa

\* Equivalent measurement equipment may be used.

# MHQ0402PSA type

## ELECTRICAL CHARACTERISTICS

### L, Q FREQUENCY CHARACTERISTICS TABLE

L(nH)typ.					Q typ.					Part No.
500MHz	800MHz	1.8GHz	2.0GHz	2.4GHz	500MHz	800MHz	1.8GHz	2.0GHz	2.4GHz	
0.2	0.2	0.2	0.2	0.2	28	40	62	65	70	MHQ0402PSA0N2BT000
0.2	0.2	0.2	0.2	0.2	28	40	62	65	70	MHQ0402PSA0N2CT000
0.3	0.3	0.3	0.3	0.3	29	37	71	77	91	MHQ0402PSA0N3BT000
0.3	0.3	0.3	0.3	0.3	29	37	71	77	91	MHQ0402PSA0N3CT000
0.4	0.4	0.4	0.4	0.4	18	23	41	44	51	MHQ0402PSA0N4BT000
0.4	0.4	0.4	0.4	0.4	18	23	41	44	51	MHQ0402PSA0N4CT000
0.4	0.4	0.4	0.4	0.4	18	23	41	44	51	MHQ0402PSA0N4ST000
0.5	0.5	0.5	0.5	0.5	18	23	40	43	49	MHQ0402PSA0N5BT000
0.5	0.5	0.5	0.5	0.5	18	23	40	43	49	MHQ0402PSA0N5CT000
0.5	0.5	0.5	0.5	0.5	18	23	40	43	49	MHQ0402PSA0N5ST000
0.6	0.6	0.6	0.6	0.6	16	21	35	38	44	MHQ0402PSA0N6BT000
0.6	0.6	0.6	0.6	0.6	16	21	35	38	44	MHQ0402PSA0N6CT000
0.6	0.6	0.6	0.6	0.6	16	21	35	38	44	MHQ0402PSA0N6ST000
0.7	0.7	0.7	0.7	0.7	17	21	35	38	43	MHQ0402PSA0N7BT000
0.7	0.7	0.7	0.7	0.7	17	21	35	38	43	MHQ0402PSA0N7CT000
0.7	0.7	0.7	0.7	0.7	17	21	35	38	43	MHQ0402PSA0N7ST000
0.8	0.8	0.8	0.8	0.8	17	21	35	38	43	MHQ0402PSA0N8BT000
0.8	0.8	0.8	0.8	0.8	17	21	35	38	43	MHQ0402PSA0N8CT000
0.8	0.8	0.8	0.8	0.8	17	21	35	38	43	MHQ0402PSA0N8ST000
0.9	0.9	0.9	0.9	0.9	17	21	35	38	43	MHQ0402PSA0N9BT000
0.9	0.9	0.9	0.9	0.9	17	21	35	38	43	MHQ0402PSA0N9CT000
0.9	0.9	0.9	0.9	0.9	17	21	35	38	43	MHQ0402PSA0N9ST000
1.0	1.0	1.0	1.0	1.0	16	20	31	33	37	MHQ0402PSA1N0BT000
1.0	1.0	1.0	1.0	1.0	16	20	31	33	37	MHQ0402PSA1N0CT000
1.0	1.0	1.0	1.0	1.0	16	20	31	33	37	MHQ0402PSA1N0ST000
1.1	1.1	1.1	1.1	1.1	14	18	31	33	37	MHQ0402PSA1N1BT000
1.1	1.1	1.1	1.1	1.1	14	18	31	33	37	MHQ0402PSA1N1CT000
1.1	1.1	1.1	1.1	1.1	14	18	31	33	37	MHQ0402PSA1N1ST000
1.2	1.2	1.2	1.2	1.2	14	18	31	33	37	MHQ0402PSA1N2BT000
1.2	1.2	1.2	1.2	1.2	14	18	31	33	37	MHQ0402PSA1N2CT000
1.2	1.2	1.2	1.2	1.2	14	18	31	33	37	MHQ0402PSA1N2ST000
1.3	1.3	1.3	1.3	1.3	14	18	29	31	35	MHQ0402PSA1N3BT000
1.3	1.3	1.3	1.3	1.3	14	18	29	31	35	MHQ0402PSA1N3CT000
1.3	1.3	1.3	1.3	1.3	14	18	29	31	35	MHQ0402PSA1N3ST000
1.4	1.4	1.4	1.4	1.4	14	18	30	32	36	MHQ0402PSA1N4BT000
1.4	1.4	1.4	1.4	1.4	14	18	30	32	36	MHQ0402PSA1N4CT000
1.4	1.4	1.4	1.4	1.4	14	18	30	32	36	MHQ0402PSA1N4ST000
1.5	1.5	1.5	1.5	1.5	15	19	30	31	35	MHQ0402PSA1N5BT000
1.5	1.5	1.5	1.5	1.5	15	19	30	31	35	MHQ0402PSA1N5CT000
1.5	1.5	1.5	1.5	1.5	15	19	30	31	35	MHQ0402PSA1N5ST000

○ Measurement equipment

Measurement item	Product No.	Manufacturer
L, Q	4991A+16196D	Keysight Technologies
Self-resonant frequency	8720C	Keysight Technologies
DC resistance	4338A	Yokogawa

\* Equivalent measurement equipment may be used.

⚠ Please be sure to request delivery specifications that provide further details on the features and specifications of the products for proper and safe use.  
Please note that the contents may change without any prior notice due to reasons such as upgrading.

# MHQ0402PSA type

## ELECTRICAL CHARACTERISTICS

### L, Q FREQUENCY CHARACTERISTICS TABLE

L(nH)typ.					Q typ.					Part No.
500MHz	800MHz	1.8GHz	2.0GHz	2.4GHz	500MHz	800MHz	1.8GHz	2.0GHz	2.4GHz	
1.6	1.6	1.6	1.6	1.6	14	18	30	32	36	MHQ0402PSA1N6BT000
1.6	1.6	1.6	1.6	1.6	14	18	30	32	36	MHQ0402PSA1N6CT000
1.6	1.6	1.6	1.6	1.6	14	18	30	32	36	MHQ0402PSA1N6ST000
1.7	1.7	1.7	1.7	1.7	15	19	31	33	37	MHQ0402PSA1N7BT000
1.7	1.7	1.7	1.7	1.7	15	19	31	33	37	MHQ0402PSA1N7CT000
1.7	1.7	1.7	1.7	1.7	15	19	31	33	37	MHQ0402PSA1N7ST000
1.8	1.8	1.8	1.8	1.8	14	18	30	31	35	MHQ0402PSA1N8BT000
1.8	1.8	1.8	1.8	1.8	14	18	30	31	35	MHQ0402PSA1N8CT000
1.8	1.8	1.8	1.8	1.8	14	18	30	31	35	MHQ0402PSA1N8ST000
1.9	1.9	1.9	1.9	1.9	14	18	29	31	35	MHQ0402PSA1N9BT000
1.9	1.9	1.9	1.9	1.9	14	18	29	31	35	MHQ0402PSA1N9CT000
1.9	1.9	1.9	1.9	1.9	14	18	29	31	35	MHQ0402PSA1N9ST000
2.0	2.0	1.9	1.9	1.9	14	18	30	31	35	MHQ0402PSA2N0BT000
2.0	2.0	1.9	1.9	1.9	14	18	30	31	35	MHQ0402PSA2N0CT000
2.0	2.0	1.9	1.9	1.9	14	18	30	31	35	MHQ0402PSA2N0ST000
2.1	2.1	2.1	2.1	2.1	13	17	29	30	34	MHQ0402PSA2N1BT000
2.1	2.1	2.1	2.1	2.1	13	17	29	30	34	MHQ0402PSA2N1CT000
2.1	2.1	2.1	2.1	2.1	13	17	29	30	34	MHQ0402PSA2N1ST000
2.2	2.2	2.2	2.2	2.2	14	18	29	30	34	MHQ0402PSA2N2BT000
2.2	2.2	2.2	2.2	2.2	14	18	29	30	34	MHQ0402PSA2N2CT000
2.2	2.2	2.2	2.2	2.2	14	18	29	30	34	MHQ0402PSA2N2ST000
2.3	2.3	2.3	2.3	2.3	13	17	29	31	35	MHQ0402PSA2N3BT000
2.3	2.3	2.3	2.3	2.3	13	17	29	31	35	MHQ0402PSA2N3CT000
2.3	2.3	2.3	2.3	2.3	13	17	29	31	35	MHQ0402PSA2N3ST000
2.4	2.4	2.4	2.4	2.4	14	18	29	30	33	MHQ0402PSA2N4BT000
2.4	2.4	2.4	2.4	2.4	14	18	29	30	33	MHQ0402PSA2N4CT000
2.4	2.4	2.4	2.4	2.4	14	18	29	30	33	MHQ0402PSA2N4ST000
2.5	2.5	2.5	2.5	2.5	14	19	31	33	37	MHQ0402PSA2N5BT000
2.5	2.5	2.5	2.5	2.5	14	19	31	33	37	MHQ0402PSA2N5CT000
2.5	2.5	2.5	2.5	2.5	14	19	31	33	37	MHQ0402PSA2N5ST000
2.6	2.6	2.6	2.6	2.6	14	18	30	32	36	MHQ0402PSA2N6BT000
2.6	2.6	2.6	2.6	2.6	14	18	30	32	36	MHQ0402PSA2N6CT000
2.6	2.6	2.6	2.6	2.6	14	18	30	32	36	MHQ0402PSA2N6ST000
2.7	2.7	2.7	2.7	2.7	14	18	29	31	35	MHQ0402PSA2N7BT000
2.7	2.7	2.7	2.7	2.7	14	18	29	31	35	MHQ0402PSA2N7CT000
2.7	2.7	2.7	2.7	2.7	14	18	29	31	35	MHQ0402PSA2N7ST000
2.8	2.8	2.8	2.8	2.8	14	18	29	31	35	MHQ0402PSA2N8BT000
2.8	2.8	2.8	2.8	2.8	14	18	29	31	35	MHQ0402PSA2N8CT000
2.8	2.8	2.8	2.8	2.8	14	18	29	31	35	MHQ0402PSA2N8ST000
2.9	2.9	2.9	2.9	2.9	14	19	31	33	37	MHQ0402PSA2N9BT000
2.9	2.9	2.9	2.9	2.9	14	19	31	33	37	MHQ0402PSA2N9CT000
2.9	2.9	2.9	2.9	2.9	14	19	31	33	37	MHQ0402PSA2N9ST000

#### ○ Measurement equipment

Measurement item	Product No.	Manufacturer
L, Q	4991A+16196D	Keysight Technologies
Self-resonant frequency	8720C	Keysight Technologies
DC resistance	4338A	Yokogawa

\* Equivalent measurement equipment may be used.

# MHQ0402PSA type

## ELECTRICAL CHARACTERISTICS

### L, Q FREQUENCY CHARACTERISTICS TABLE

L(nH)typ.					Q typ.					Part No.
500MHz	800MHz	1.8GHz	2.0GHz	2.4GHz	500MHz	800MHz	1.8GHz	2.0GHz	2.4GHz	
3.0	3.0	3.0	3.0	3.0	14	18	31	33	37	MHQ0402PSA3N0BT000
3.0	3.0	3.0	3.0	3.0	14	18	31	33	37	MHQ0402PSA3N0CT000
3.0	3.0	3.0	3.0	3.0	14	18	31	33	37	MHQ0402PSA3N0ST000
3.1	3.1	3.1	3.1	3.1	14	18	30	32	36	MHQ0402PSA3N1BT000
3.1	3.1	3.1	3.1	3.1	14	18	30	32	36	MHQ0402PSA3N1CT000
3.1	3.1	3.1	3.1	3.1	14	18	30	32	36	MHQ0402PSA3N1ST000
3.2	3.2	3.2	3.2	3.2	14	18	29	31	34	MHQ0402PSA3N2BT000
3.2	3.2	3.2	3.2	3.2	14	18	29	31	34	MHQ0402PSA3N2CT000
3.2	3.2	3.2	3.2	3.2	14	18	29	31	34	MHQ0402PSA3N2ST000
3.3	3.3	3.3	3.3	3.3	14	18	30	32	35	MHQ0402PSA3N3BT000
3.3	3.3	3.3	3.3	3.3	14	18	30	32	35	MHQ0402PSA3N3CT000
3.3	3.3	3.3	3.3	3.3	14	18	30	32	35	MHQ0402PSA3N3ST000
3.4	3.4	3.4	3.4	3.4	14	18	30	32	36	MHQ0402PSA3N4BT000
3.4	3.4	3.4	3.4	3.4	14	18	30	32	36	MHQ0402PSA3N4CT000
3.4	3.4	3.4	3.4	3.4	14	18	30	32	36	MHQ0402PSA3N4ST000
3.5	3.5	3.4	3.4	3.5	15	18	29	31	34	MHQ0402PSA3N5BT000
3.5	3.5	3.4	3.4	3.5	15	18	29	31	34	MHQ0402PSA3N5CT000
3.5	3.5	3.4	3.4	3.5	15	18	29	31	34	MHQ0402PSA3N5ST000
3.6	3.6	3.6	3.6	3.6	14	18	29	31	35	MHQ0402PSA3N6BT000
3.6	3.6	3.6	3.6	3.6	14	18	29	31	35	MHQ0402PSA3N6CT000
3.6	3.6	3.6	3.6	3.6	14	18	29	31	35	MHQ0402PSA3N6ST000
3.7	3.7	3.7	3.7	3.7	14	18	30	31	35	MHQ0402PSA3N7BT000
3.7	3.7	3.7	3.7	3.7	14	18	30	31	35	MHQ0402PSA3N7CT000
3.7	3.7	3.7	3.7	3.7	14	18	30	31	35	MHQ0402PSA3N7ST000
3.8	3.8	3.8	3.8	3.8	15	19	31	33	37	MHQ0402PSA3N8BT000
3.8	3.8	3.8	3.8	3.8	15	19	31	33	37	MHQ0402PSA3N8CT000
3.8	3.8	3.8	3.8	3.8	15	19	31	33	37	MHQ0402PSA3N8ST000
3.9	3.9	3.9	3.9	4.0	14	19	31	33	36	MHQ0402PSA3N9BT000
3.9	3.9	3.9	3.9	4.0	14	19	31	33	36	MHQ0402PSA3N9CT000
3.9	3.9	3.9	3.9	4.0	14	19	31	33	36	MHQ0402PSA3N9ST000
4.0	4.0	4.0	4.0	4.1	14	19	30	32	36	MHQ0402PSA4N0BT000
4.0	4.0	4.0	4.0	4.1	14	19	30	32	36	MHQ0402PSA4N0CT000
4.0	4.0	4.0	4.0	4.1	14	19	30	32	36	MHQ0402PSA4N0ST000
4.1	4.1	4.1	4.1	4.1	14	19	31	32	36	MHQ0402PSA4N1BT000
4.1	4.1	4.1	4.1	4.1	14	19	31	32	36	MHQ0402PSA4N1CT000
4.1	4.1	4.1	4.1	4.1	14	19	31	32	36	MHQ0402PSA4N1ST000
4.2	4.2	4.2	4.2	4.3	14	18	30	32	36	MHQ0402PSA4N2BT000
4.2	4.2	4.2	4.2	4.3	14	18	30	32	36	MHQ0402PSA4N2CT000
4.2	4.2	4.2	4.2	4.3	14	18	30	32	36	MHQ0402PSA4N2ST000
4.3	4.3	4.3	4.3	4.3	14	19	30	32	35	MHQ0402PSA4N3HT000
4.3	4.3	4.3	4.3	4.3	14	19	30	32	35	MHQ0402PSA4N3JT000
4.7	4.7	4.7	4.7	4.8	14	18	29	31	34	MHQ0402PSA4N7HT000
4.7	4.7	4.7	4.7	4.8	14	18	29	31	34	MHQ0402PSA4N7JT000

#### ○ Measurement equipment

Measurement item	Product No.	Manufacturer
L、Q	4991A+16196D	Keysight Technologies
Self-resonant frequency	8720C	Keysight Technologies
DC resistance	4338A	Yokogawa

\* Equivalent measurement equipment may be used.

# MHQ0402PSA type

## ELECTRICAL CHARACTERISTICS

### L, Q FREQUENCY CHARACTERISTICS TABLE

L(nH)typ.					Q typ.					Part No.
500MHz	800MHz	1.8GHz	2.0GHz	2.4GHz	500MHz	800MHz	1.8GHz	2.0GHz	2.4GHz	
5.1	5.1	5.1	5.2	5.3	14	18	29	31	34	MHQ0402PSA5N1HT000
5.1	5.1	5.1	5.2	5.3	14	18	29	31	34	MHQ0402PSA5N1JT000
5.6	5.6	5.6	5.7	5.8	14	19	30	31	35	MHQ0402PSA5N6HT000
5.6	5.6	5.6	5.7	5.8	14	19	30	31	35	MHQ0402PSA5N6JT000
6.2	6.1	6.2	6.3	6.4	15	19	29	31	34	MHQ0402PSA6N2HT000
6.2	6.1	6.2	6.3	6.4	15	19	29	31	34	MHQ0402PSA6N2JT000
6.8	6.8	6.9	7.0	7.1	15	19	30	32	35	MHQ0402PSA6N8HT000
6.8	6.8	6.9	7.0	7.1	15	19	30	32	35	MHQ0402PSA6N8JT000
7.5	7.5	7.7	7.8	8.0	14	19	29	30	33	MHQ0402PSA7N5HT000
7.5	7.5	7.7	7.8	8.0	14	19	29	30	33	MHQ0402PSA7N5JT000
8.2	8.2	8.4	8.5	8.8	15	19	29	30	33	MHQ0402PSA8N2HT000
8.2	8.2	8.4	8.5	8.8	15	19	29	30	33	MHQ0402PSA8N2JT000
9.1	9.0	9.2	9.3	9.6	14	18	28	29	31	MHQ0402PSA9N1HT000
9.1	9.0	9.2	9.3	9.6	14	18	28	29	31	MHQ0402PSA9N1JT000
10.0	9.9	10.3	10.4	10.8	12	15	24	25	28	MHQ0402PSA10NHT000
10.0	9.9	10.3	10.4	10.8	12	15	24	25	28	MHQ0402PSA10NJT000
11.0	10.9	11.3	11.5	12.0	13	16	23	25	26	MHQ0402PSA11NHT000
11.0	10.9	11.3	11.5	12.0	13	16	23	25	26	MHQ0402PSA11NJT000
12.0	11.9	12.4	12.6	13.2	12	15	21	22	24	MHQ0402PSA12NHT000
12.0	11.9	12.4	12.6	13.2	12	15	21	22	24	MHQ0402PSA12NJT000
13.0	12.9	13.6	14.0	14.8	12	15	21	22	23	MHQ0402PSA13NHT000
13.0	12.9	13.6	14.0	14.8	12	15	21	22	23	MHQ0402PSA13NJT000
15.0	14.9	15.9	16.3	17.3	12	15	22	23	24	MHQ0402PSA15NHT000
15.0	14.9	15.9	16.3	17.3	12	15	22	23	24	MHQ0402PSA15NJT000
16.0	15.9	16.9	17.4	18.6	12	15	20	21	22	MHQ0402PSA16NHT000
16.0	15.9	16.9	17.4	18.6	12	15	20	21	22	MHQ0402PSA16NJT000
18.0	18.0	19.7	20.5	22.4	12	15	20	21	20	MHQ0402PSA18NHT000
18.0	18.0	19.7	20.5	22.4	12	15	20	21	20	MHQ0402PSA18NJT000
20.0	20.0	22.4	23.5	26.1	12	15	20	20	20	MHQ0402PSA20NHT000
20.0	20.0	22.4	23.5	26.1	12	15	20	20	20	MHQ0402PSA20NJT000
22.0	22.0	24.8	26.1	29.4	12	14	18	18	17	MHQ0402PSA22NHT000
22.0	22.0	24.8	26.1	29.4	12	14	18	18	17	MHQ0402PSA22NJT000

### ○ Measurement equipment

Measurement item	Product No.	Manufacturer
L, Q	4991A+16196D	Keysight Technologies
Self-resonant frequency	8720C	Keysight Technologies
DC resistance	4338A	Yokogawa

\* Equivalent measurement equipment may be used.

# MHQ0402PSA type

## ELECTRICAL CHARACTERISTICS

### L FREQUENCY CHARACTERISTICS GRAPH (EXAMPLE)

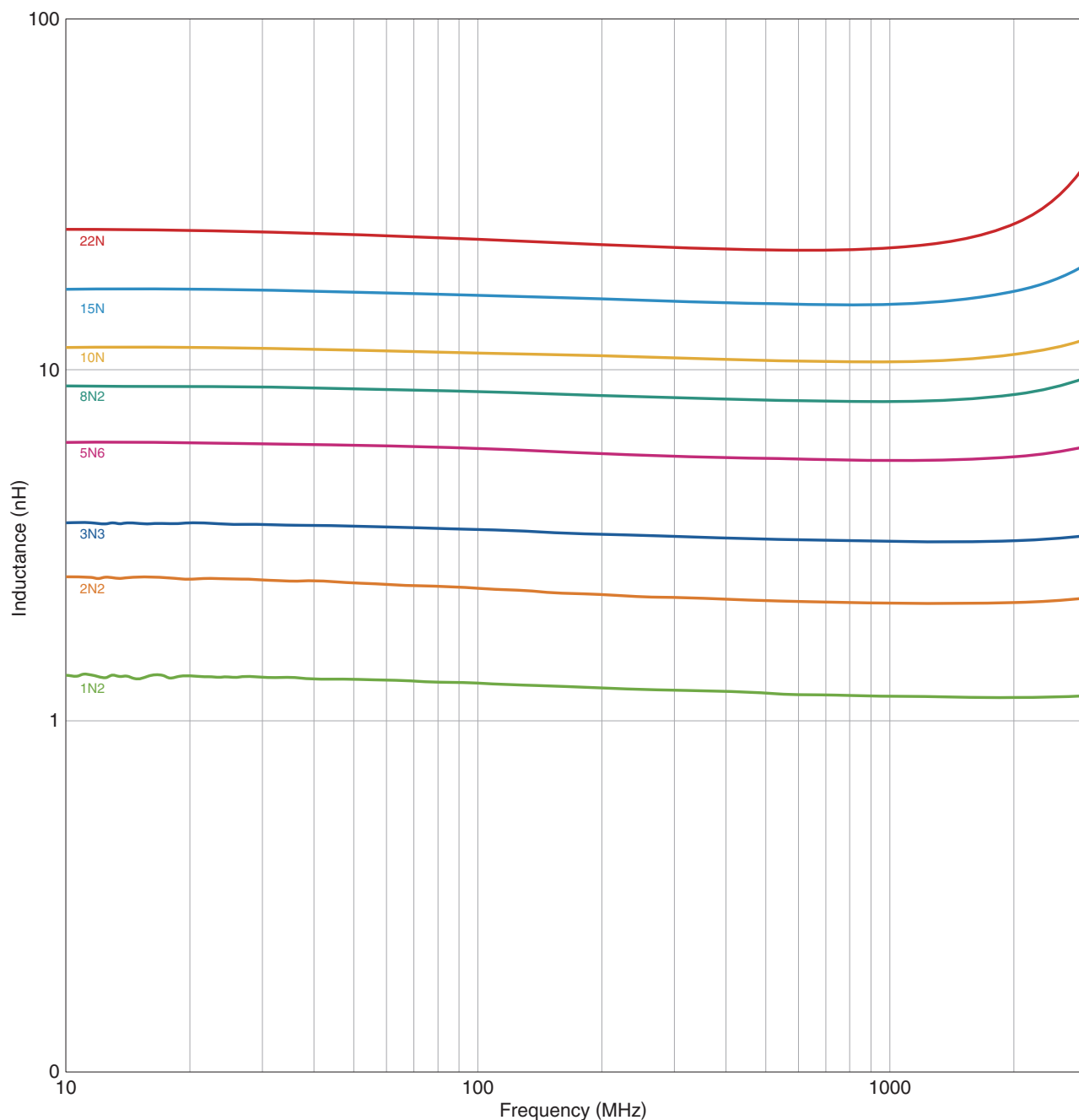

○ Measurement equipment

Product No.	Manufacturer
E4991A+16196D	Keysight Technologies

\* Equivalent measurement equipment may be used.

⚠ Please be sure to request delivery specifications that provide further details on the features and specifications of the products for proper and safe use.  
Please note that the contents may change without any prior notice due to reasons such as upgrading.

# MHQ0402PSA type

## ELECTRICAL CHARACTERISTICS

### Q FREQUENCY CHARACTERISTICS GRAPH (EXAMPLE)

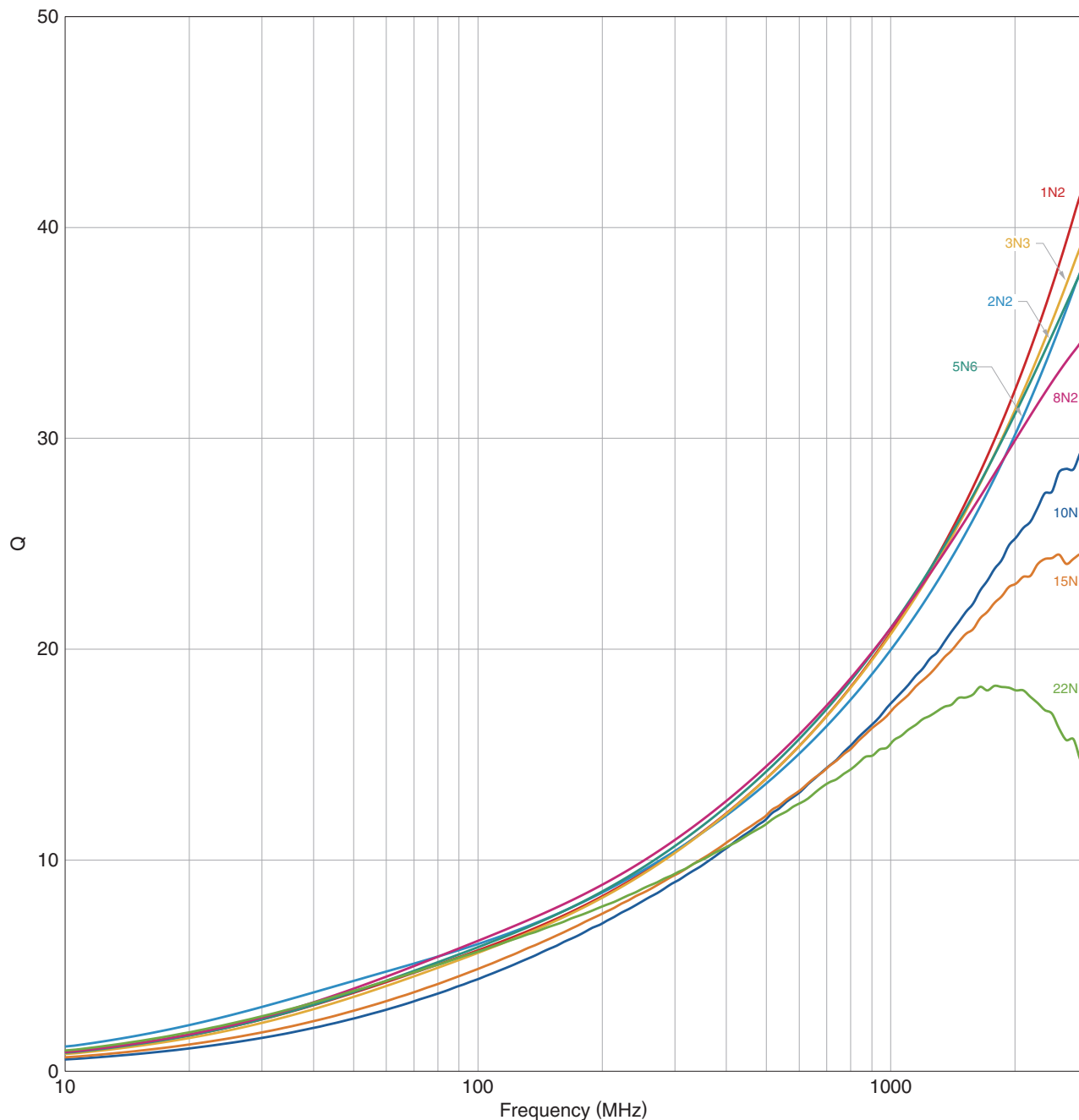

○ Measurement equipment

Product No.	Manufacturer
E4991A+16196D	Keysight Technologies

\* Equivalent measurement equipment may be used.

⚠ Please be sure to request delivery specifications that provide further details on the features and specifications of the products for proper and safe use.  
Please note that the contents may change without any prior notice due to reasons such as upgrading.

# MHQ0402PSA type

## PACKAGING STYLE

### REEL DIMENSIONS

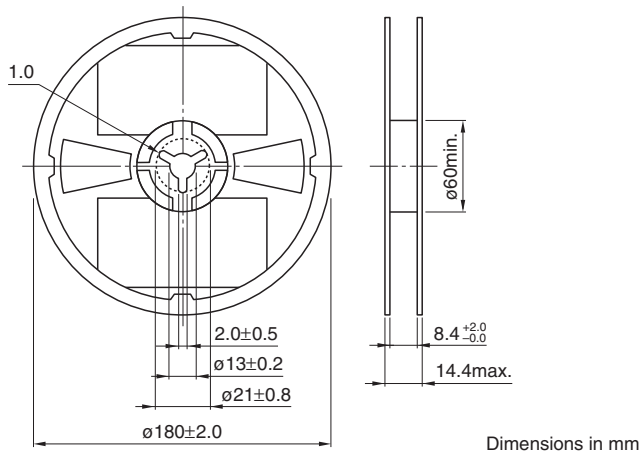

### TAPE DIMENSIONS

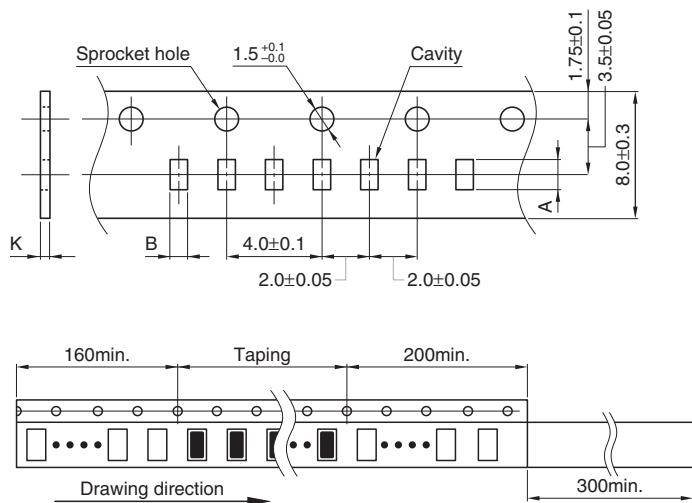

Type	A	B	K
MHQ0402PSA	0.46±0.04	0.26±0.04	0.40 max.

⚠ Please be sure to request delivery specifications that provide further details on the features and specifications of the products for proper and safe use. Please note that the contents may change without any prior notice due to reasons such as upgrading.