

Multilayer Band Pass Filters

For 2.4GHz W-LAN/Bluetooth

DEA Series

Type: **DEA252450BT-2080B2 (2.5×2.0×0.9mm)**
 DEA252450BT-2024C2 (2.5×2.0×0.9mm)
 DEA252450BT-2024C5 (2.5×2.0×1.0mm max.)
 DEA252400BT-2030A1 (2.5×2.0×1.0mm max.)
 DEA252450BT-2024D4 (2.5×2.0×1.0mm max.)
 DEA252450BT-2027A1 (2.5×2.0×1.0mm max.)
 DEA252450BT-2031A1 (2.5×2.0×1.0mm max.)
 DEA252450BT-2063C1 (2.5×2.0×1.0mm max.)
 DEA252450BT-2109C3 (2.5×2.0×1.0mm max.)
 DEA252450BT-2037C1 (2.5×2.0×1.5mm max.)

Issue date: December 2011

- All specifications are subject to change without notice.
 - Conformity to RoHS Directive: This means that, in conformity with EU Directive 2002/95/EC, lead, cadmium, mercury, hexavalent chromium, and specific bromine-based flame retardants, PBB and PBDE, have not been used, except for exempted applications.
-

Multilayer Chip Band Pass Filters For Bluetooth & 2.4GHz W-LAN

Conformity to RoHS Directive

DEA Series DEA252450BT-2080B2

SHAPES AND DIMENSIONS

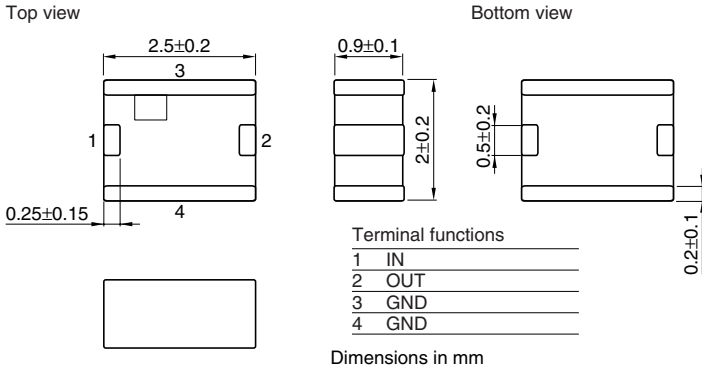

RECOMMENDED PC BOARD PATTERNS

LAND

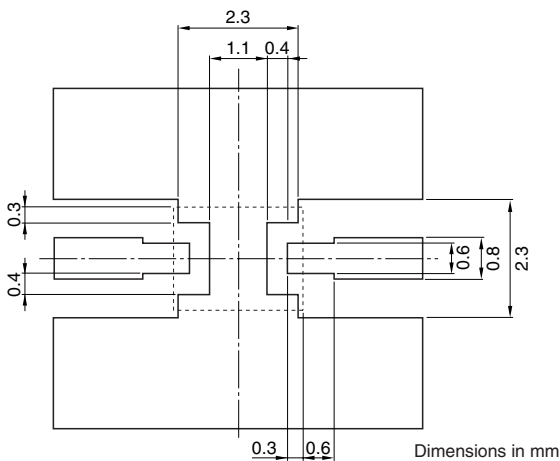

Line width be designed to match 50Ω characteristic impedance depending on PCB material and thickness.

SOLDER RESIST

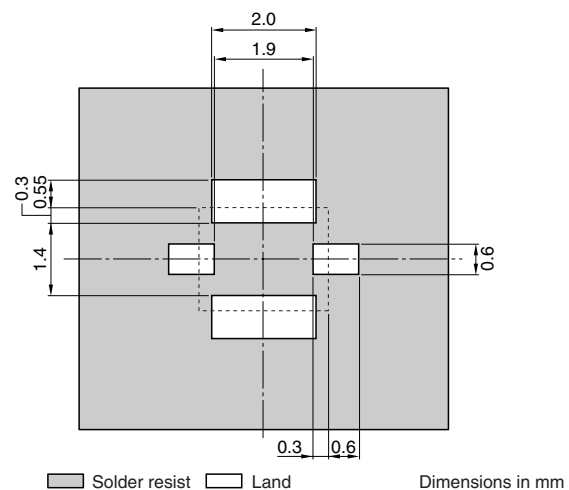

ELECTRICAL CHARACTERISTICS

Item			Minimum value	Typical value	Maximum value
Insertion loss	[2400 to 2500MHz]	(dB)	—	1.56	2.0
Return loss	[2400 to 2500MHz]	(dB)	10.0	24.4	—
	[824 to 849MHz]	(dB)	52.0	54.8	—
	[869 to 894MHz]	(dB)	52.0	54.8	—
	[894 to 915MHz]	(dB)	52.0	54.1	—
	[925 to 960MHz]	(dB)	52.0	54.1	—
	[1570 to 1580MHz]	(dB)	54.0	58.2	—
	[1710 to 1785MHz]	(dB)	54.0	68.0	—
	[1805 to 1850MHz]	(dB)	54.0	69.2	—
	[1850 to 1910MHz]	(dB)	54.0	68.4	—
	[1930 to 1990MHz]	(dB)	48.0	51.7	—
	[2100MHz]	(dB)	25.0	32.8	—
	[4800 to 5000MHz]	(dB)	40.0	52.1	—
	[7200 to 7500MHz]	(dB)	21.0	32.7	—
Temperature range	Operating	(°C)	−40	—	+85
	Storage	(°C)	−40	—	+85

• Ta:+25°C

• Conformity to RoHS Directive: This means that, in conformity with EU Directive 2002/95/EC, lead, cadmium, mercury, hexavalent chromium, and specific bromine-based flame retardants, PBB and PBDE, have not been used, except for exempted applications.

• All specifications are subject to change without notice.

FREQUENCY CHARACTERISTICS

INSERTION LOSS

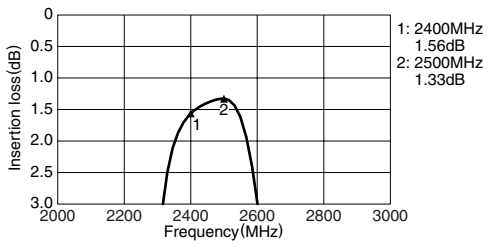

ATTENUATION

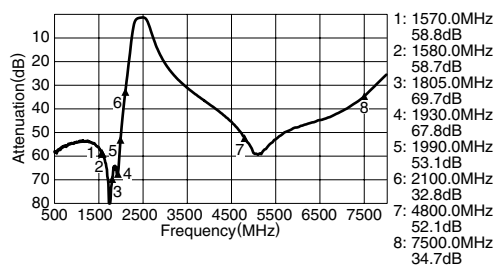

RETURN LOSS

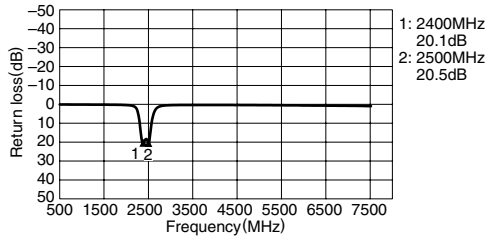

VSWR

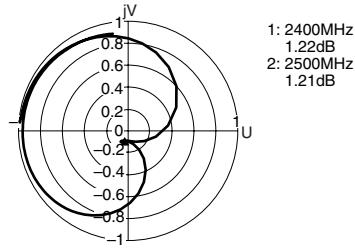

• All specifications are subject to change without notice.

Multilayer Chip Band Pass Filters For Bluetooth & 2.4GHz W-LAN

Conformity to RoHS Directive

DEA Series DEA252450BT-2024C2

SHAPES AND DIMENSIONS

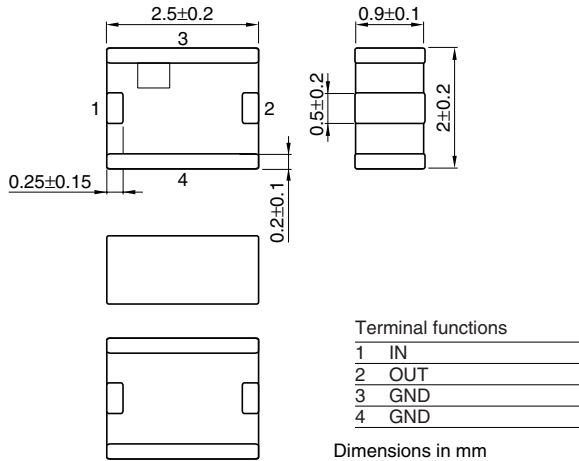

RECOMMENDED PC BOARD PATTERNS

LAND

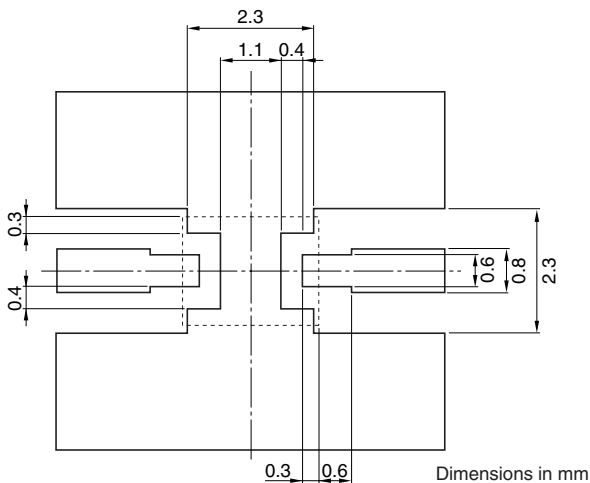

Line width be designed to match 50Ω characteristic impedance depending on PCB material and thickness.

SOLDER RESIST

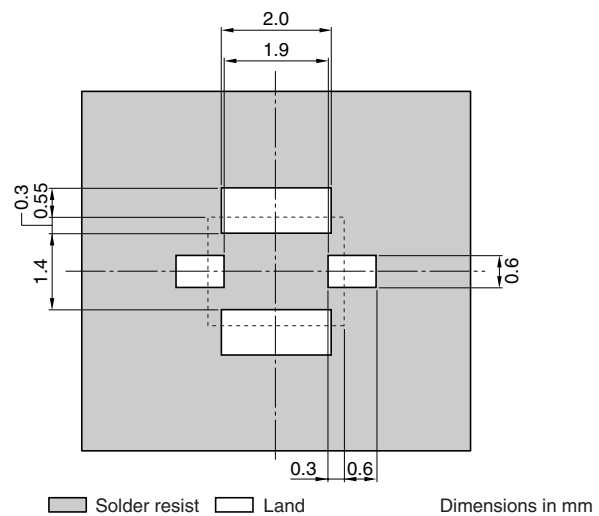

ELECTRICAL CHARACTERISTICS

Item			Minimum value	Typical value	Maximum value
Insertion loss	[2400 to 2800MHz]	(dB)	—	—	3.0
Return loss	[2400 to 2800MHz]	(dB)	10.0	—	—
	[880 to 960MHz]	(dB)	50.0	—	—
	[1565 to 1585MHz]	(dB)	50.0	—	—
Attenuation	[1710 to 1880MHz]	(dB)	48.0	—	—
	[1930 to 1990MHz]	(dB)	48.0	—	—
	[2110 to 2170MHz]	(dB)	22.0	—	—
Temperature range	Operating	(°C)	-40	—	+85
	Storage	(°C)	-40	—	+85

• Ta: +25°C

• Conformity to RoHS Directive: This means that, in conformity with EU Directive 2002/95/EC, lead, cadmium, mercury, hexavalent chromium, and specific bromine-based flame retardants, PBB and PBDE, have not been used, except for exempted applications.

• All specifications are subject to change without notice.

FREQUENCY CHARACTERISTICS

INSERTION LOSS

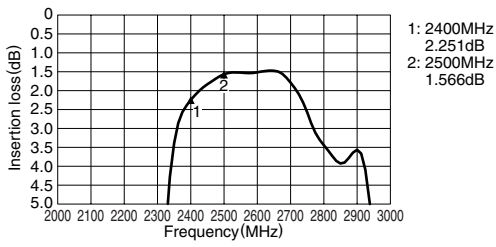

ATTENUATION

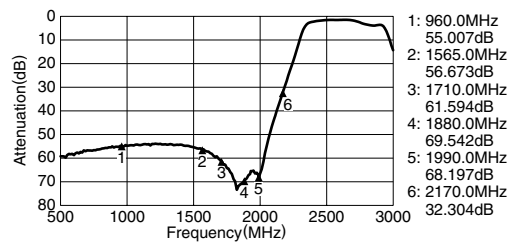

RETURN LOSS

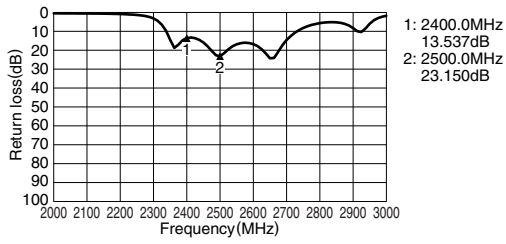

VSWR

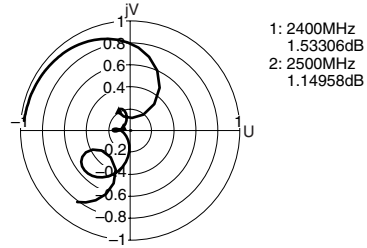

Multilayer Chip Band Pass Filters For Bluetooth & 2.4GHz W-LAN

Conformity to RoHS Directive

DEA Series DEA252450BT-2024C5

SHAPES AND DIMENSIONS

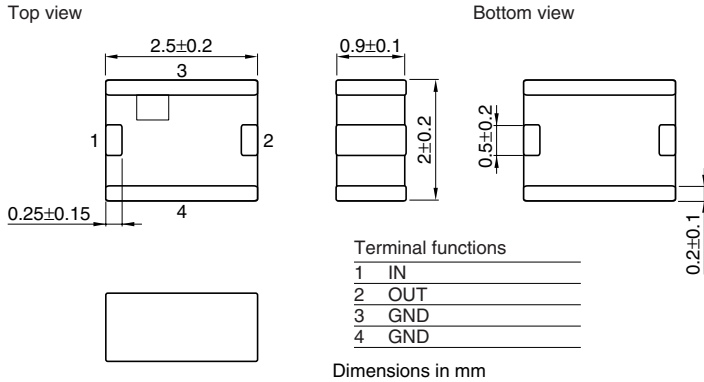

RECOMMENDED PC BOARD PATTERNS

LAND

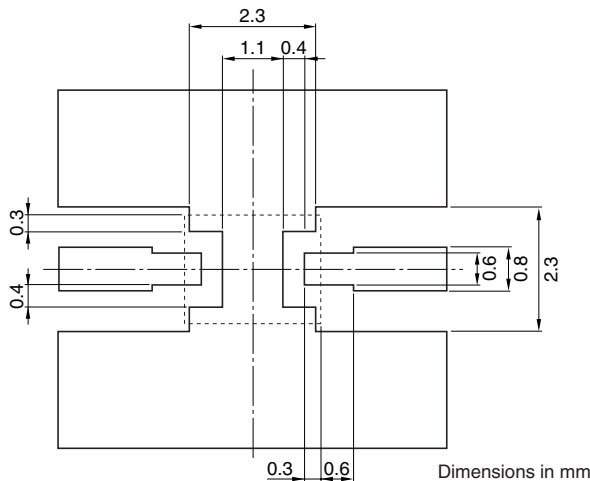

Line width be designed to match 50Ω characteristic impedance depending on PCB material and thickness.

SOLDER RESIST

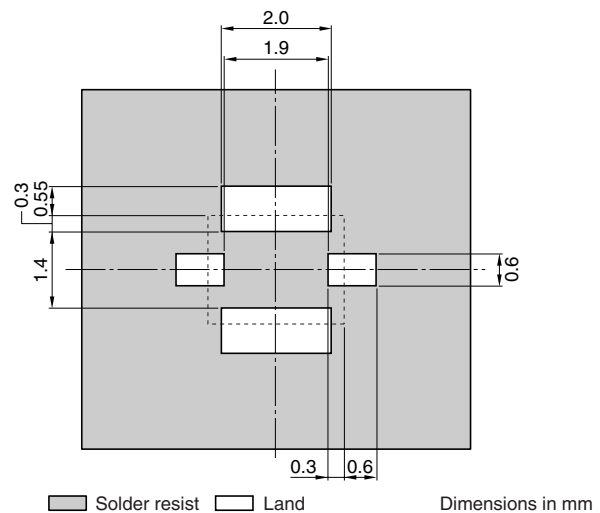

ELECTRICAL CHARACTERISTICS

Item			Minimum value	Typical value	Maximum value
Center frequency	[2450MHz]		—	—	
Insertion loss	[2400 to 2500MHz]	(dB)	—	—	2.1
Return loss	[2400 to 2500MHz]	(dB)	10.0	—	—
Attenuation	[880 to 915MHz]	(dB)	45.0	—	—
	[1710 to 1990MHz]	(dB)	48.0	—	—
	[2110 to 2170MHz]	(dB)	20.0	—	—
	[3000MHz]	(dB)	14.0	—	—
	[4800 to 5000MHz]	(dB)	30.0	—	—
Temperature range	Operating	(°C)	-40	—	+85
	Storage	(°C)	-40	—	+85

• Ta: +25°C

• Conformity to RoHS Directive: This means that, in conformity with EU Directive 2002/95/EC, lead, cadmium, mercury, hexavalent chromium, and specific bromine-based flame retardants, PBB and PBDE, have not been used, except for exempted applications.

• All specifications are subject to change without notice.

FREQUENCY CHARACTERISTICS

INSERTION LOSS

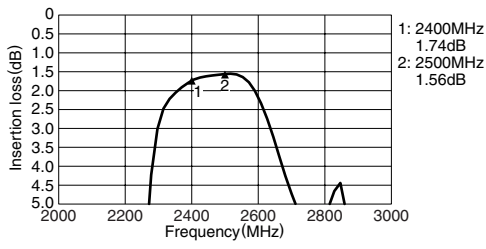

ATTENUATION

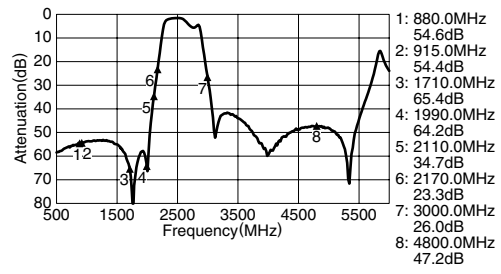

RETURN LOSS

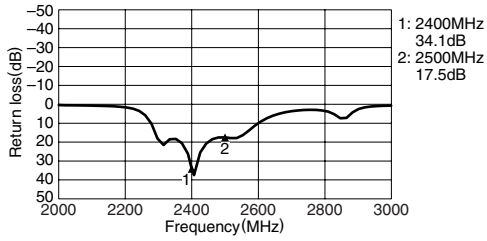

VSWR

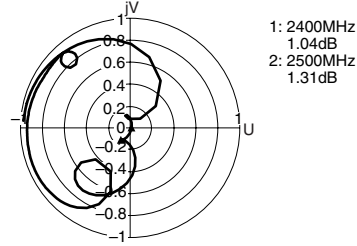

Multilayer Chip Band Pass Filters For Bluetooth & 2.4GHz W-LAN

Conformity to RoHS Directive

DEA Series DEA252400BT-2030A1

SHAPES AND DIMENSIONS

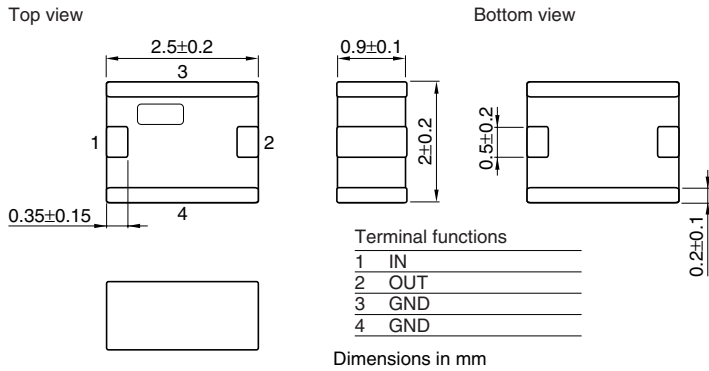

RECOMMENDED PC BOARD PATTERNS

LAND

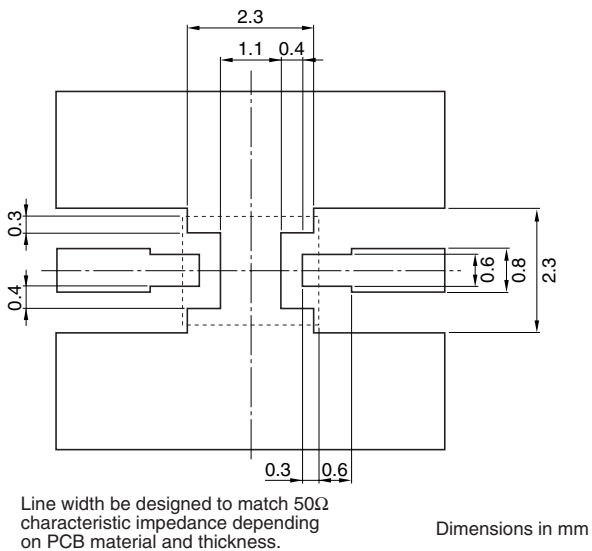

SOLDER RESIST

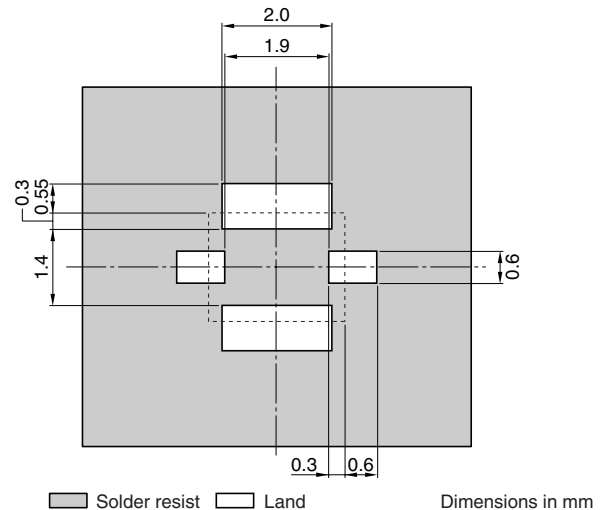

ELECTRICAL CHARACTERISTICS

Item			Minimum value	Typical value	Maximum value
Insertion loss	[2300 to 2500MHz]	(dB)	—	—	1.4
Return loss	[2300 to 2500MHz]	(dB)	10	—	—
Attenuation	[880 to 915MHz]	(dB)	35	—	—
	[1710 to 1785MHz]	(dB)	35	—	—
	[1850 to 1910MHz]	(dB)	35	—	—
Temperature range	[4800 to 5000MHz]	(dB)	30	—	—
	Operating	(°C)	−40	—	+85
	Storage	(°C)	−40	—	+85

• Ta: +25°C

• Conformity to RoHS Directive: This means that, in conformity with EU Directive 2002/95/EC, lead, cadmium, mercury, hexavalent chromium, and specific bromine-based flame retardants, PBB and PBDE, have not been used, except for exempted applications.

• All specifications are subject to change without notice.

FREQUENCY CHARACTERISTICS

INSERTION LOSS

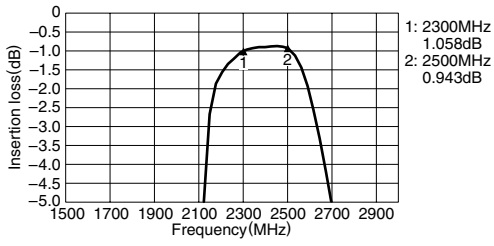

ATTENUATION

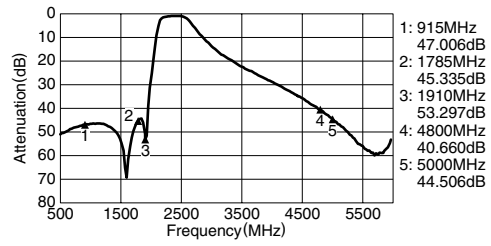

RETURN LOSS

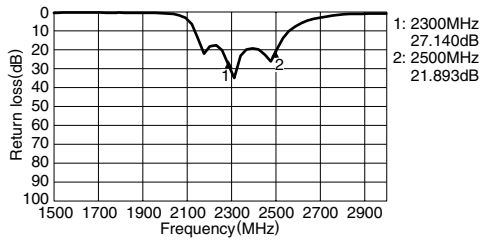

VSWR

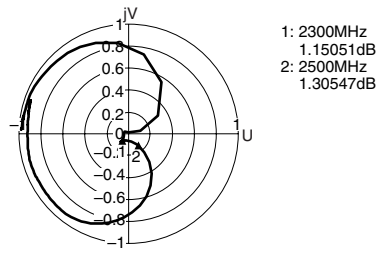

• All specifications are subject to change without notice.

Multilayer Chip Band Pass Filters For Bluetooth & 2.4GHz W-LAN

Conformity to RoHS Directive

DEA Series DEA252450BT-2024D4

SHAPES AND DIMENSIONS

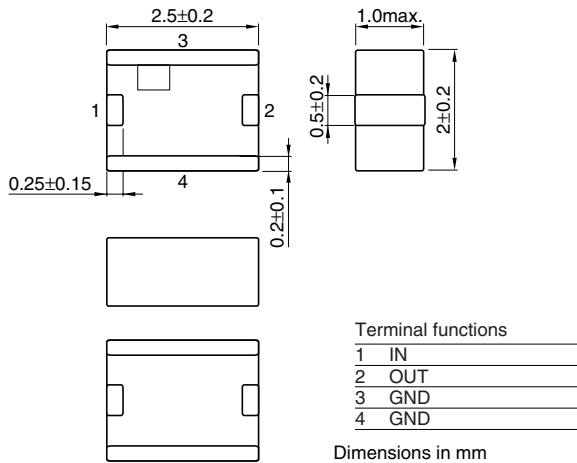

RECOMMENDED PC BOARD PATTERNS

LAND

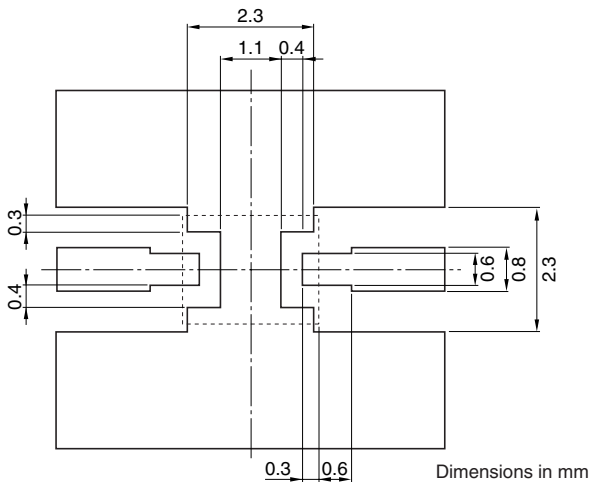

Line width be designed to match 50Ω characteristic impedance depending on PCB material and thickness.

SOLDER RESIST

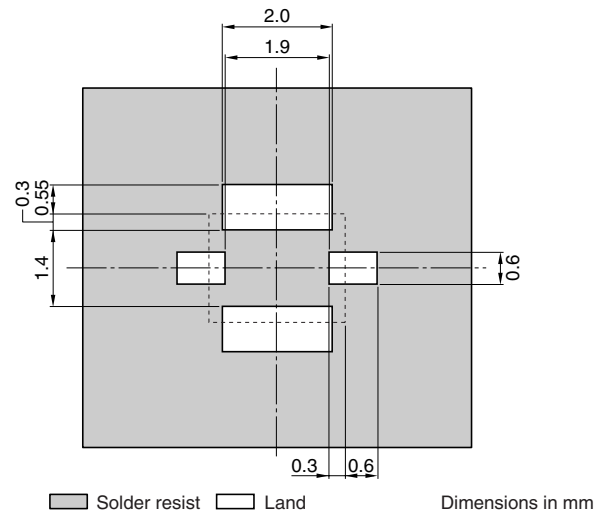

ELECTRICAL CHARACTERISTICS

Item			Minimum value	Typical value	Maximum value
Insertion loss	[2400 to 2500MHz]	(dB)	—	2.23	3.0
Return loss	[2400 to 2500MHz]	(dB)	10.0	18.2	—
Attenuation	[880 to 960MHz]	(dB)	50.0	52.6	—
	[1565 to 1585MHz]	(dB)	50.0	55.2	—
	[1710 to 1880MHz]	(dB)	40.0	49.4	—
	[1930 to 1990MHz]	(dB)	40.0	42.9	—
	[2110 to 2170MHz]	(dB)	33.0	42.8	—
Temperature range	Operating	(°C)	−40	—	+85
	Storage	(°C)	−40	—	+85

• Ta: +25°C

• Conformity to RoHS Directive: This means that, in conformity with EU Directive 2002/95/EC, lead, cadmium, mercury, hexavalent chromium, and specific bromine-based flame retardants, PBB and PBDE, have not been used, except for exempted applications.

• All specifications are subject to change without notice.

FREQUENCY CHARACTERISTICS

INSERTION LOSS

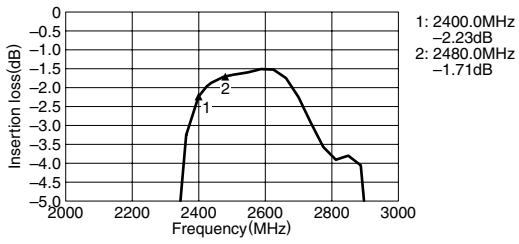

ATTENUATION

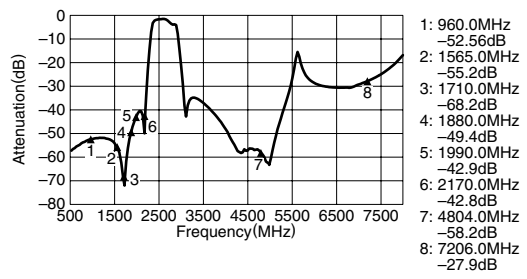

RETURN LOSS

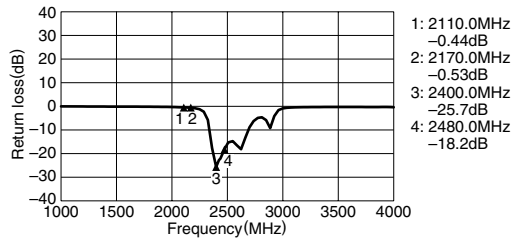

VSWR

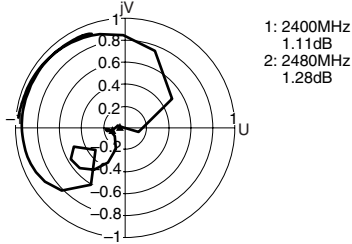

• All specifications are subject to change without notice.

Multilayer Chip Band Pass Filters For Bluetooth & 2.4GHz W-LAN

Conformity to RoHS Directive

DEA Series DEA252450BT-2027A1

SHAPES AND DIMENSIONS

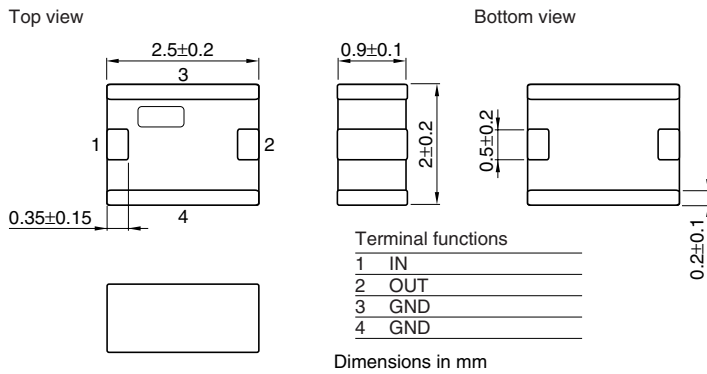

RECOMMENDED PC BOARD PATTERNS

LAND

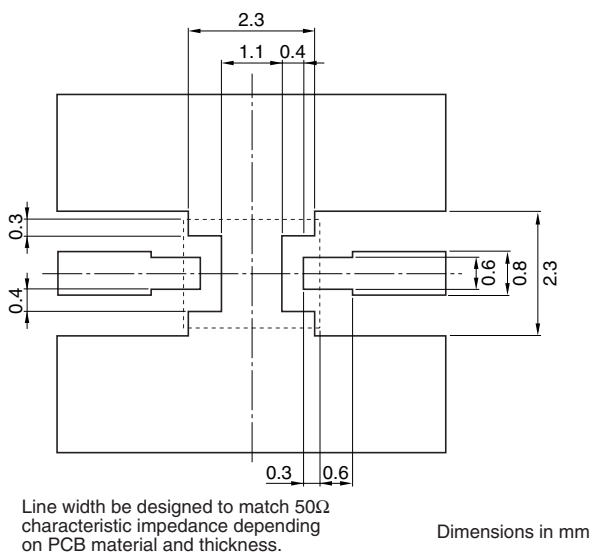

SOLDER RESIST

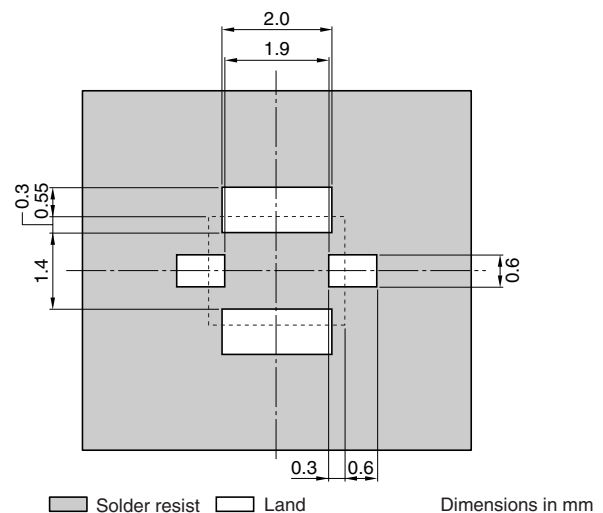

ELECTRICAL CHARACTERISTICS

Item			Minimum value	Typical value	Maximum value
Insertion loss	[2400 to 2500MHz]	(dB)	—	—	1.2
Return loss	[2400 to 2500MHz]	(dB)	10	—	—
Attenuation	[880 to 915MHz]	(dB)	35	—	—
	[1710 to 1785MHz]	(dB)	35	—	—
	[1850 to 1910MHz]	(dB)	35	—	—
	[4800 to 5000MHz]	(dB)	30	—	—
Temperature range	Operating	(°C)	−40	—	+85
	Storage	(°C)	−40	—	+85

• Ta: +25°C

• Conformity to RoHS Directive: This means that, in conformity with EU Directive 2002/95/EC, lead, cadmium, mercury, hexavalent chromium, and specific bromine-based flame retardants, PBB and PBDE, have not been used, except for exempted applications.

• All specifications are subject to change without notice.

FREQUENCY CHARACTERISTICS

INSERTION LOSS

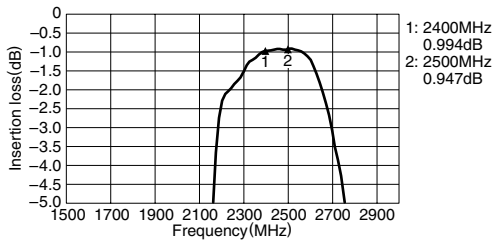

ATTENUATION

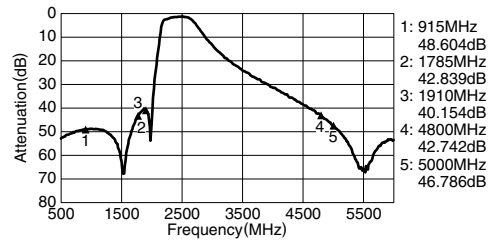

RETURN LOSS

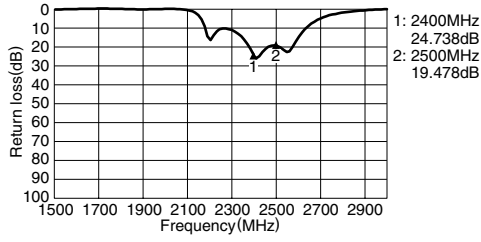

VSWR

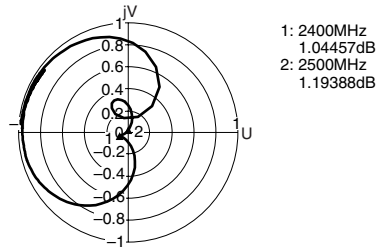

• All specifications are subject to change without notice.

Multilayer Chip Band Pass Filters For Bluetooth & 2.4GHz W-LAN

Conformity to RoHS Directive

DEA Series DEA252450BT-2031A1

SHAPES AND DIMENSIONS

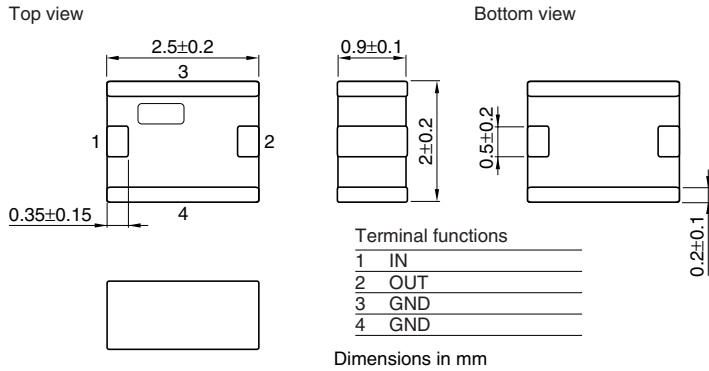

RECOMMENDED PC BOARD PATTERNS

LAND

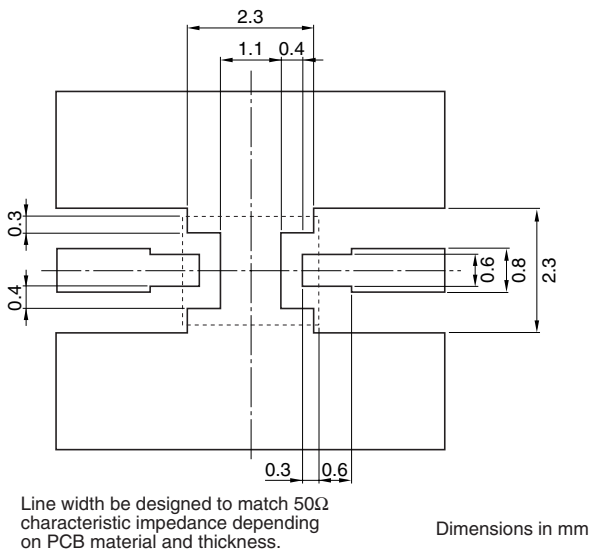

SOLDER RESIST

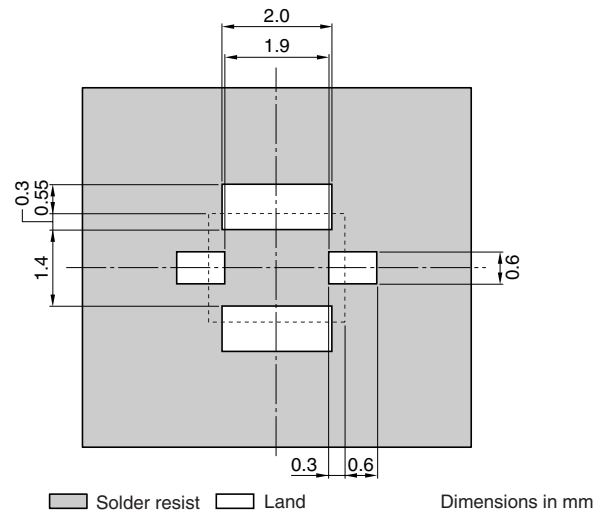

ELECTRICAL CHARACTERISTICS

Item			Minimum value	Typical value	Maximum value
Insertion loss	[2400 to 2500MHz]	(dB)	—	—	1.5
Return loss	[2400 to 2500MHz]	(dB)	10	—	—
Attenuation	[915MHz]	(dB)	35	—	—
	[1750MHz]	(dB)	30	—	—
	[2100MHz]	(dB)	20	—	—
	[4800 to 5000MHz]	(dB)	23	—	—
Temperature range	Operating	(°C)	−40	—	+85
	Storage	(°C)	−40	—	+85

• Ta: +25°C

• Conformity to RoHS Directive: This means that, in conformity with EU Directive 2002/95/EC, lead, cadmium, mercury, hexavalent chromium, and specific bromine-based flame retardants, PBB and PBDE, have not been used, except for exempted applications.

• All specifications are subject to change without notice.

FREQUENCY CHARACTERISTICS

INSERTION LOSS

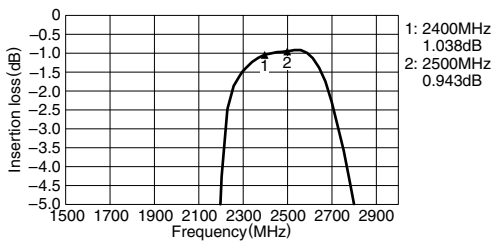

ATTENUATION

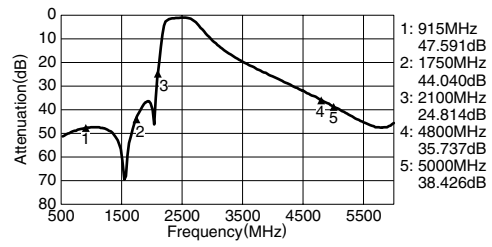

RETURN LOSS

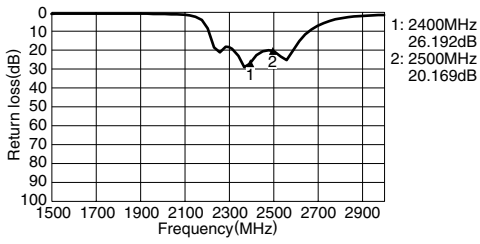

VSWR

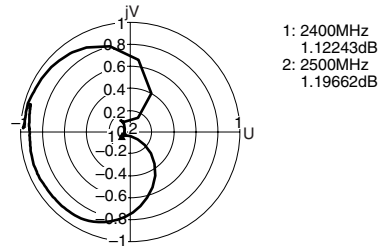

Multilayer Chip Band Pass Filters For Bluetooth & 2.4GHz W-LAN

Conformity to RoHS Directive

DEA Series DEA252450BT-2063C1

SHAPES AND DIMENSIONS

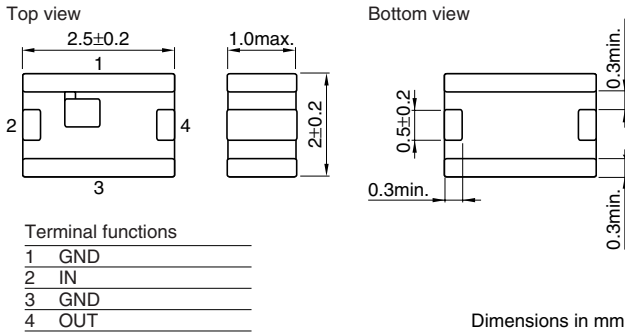

RECOMMENDED PC BOARD PATTERNS

LAND

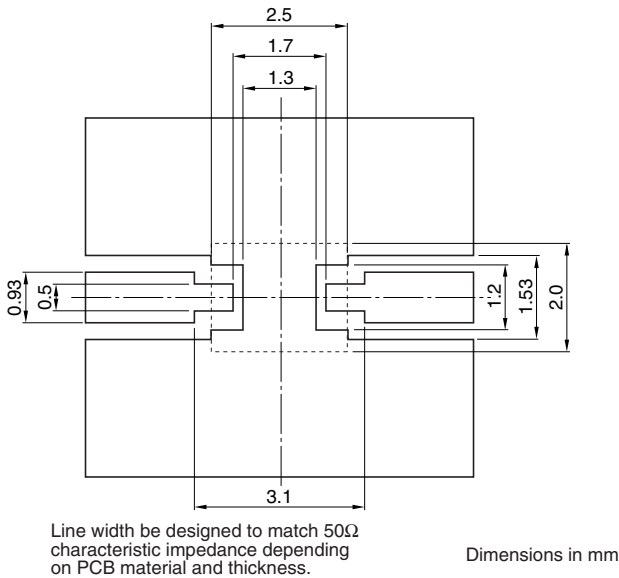

SOLDER RESIST

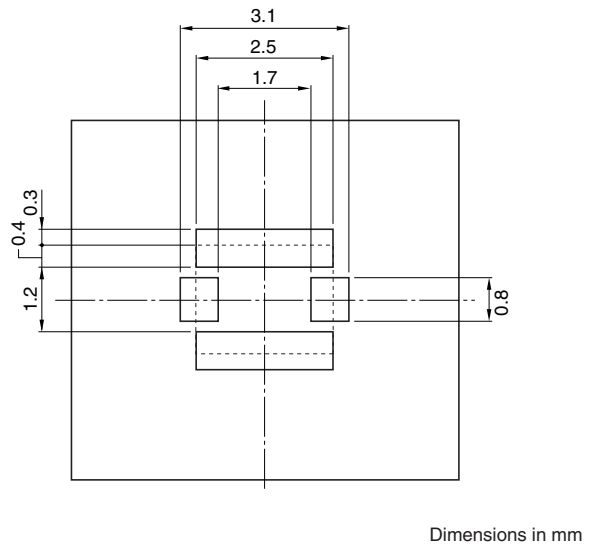

- Conformity to RoHS Directive: This means that, in conformity with EU Directive 2002/95/EC, lead, cadmium, mercury, hexavalent chromium, and specific bromine-based flame retardants, PBB and PBDE, have not been used, except for exempted applications.

- All specifications are subject to change without notice.

ELECTRICAL CHARACTERISTICS

Frequency range(Pass band)		2400 to 2500MHz
Insertion loss	[+25°C]	2.5dB max.
	[-40 to +85°C]	2.8dB max.
Single ended port characteristic impedance		50Ω (Nominal)
Return loss	[2400 to 2500MHz]	10dB min.
Ripple	[2400 to 2500MHz]	1.0dB max.
	[824 to 829MHz]	47dB min.
	[880 to 915MHz]	47dB min.
	[1525 to 1559MHz]	42dB min.
	[1710 to 1785MHz]	47dB min.
	[1850 to 1910MHz]	47dB min.
	[2110 to 2170MHz]	35dB min.
Attenuation	[4800 to 5000MHz]	30dB min.
	Operating	-40 to +85°C
	Storage	-40 to +85°C

• Ta:+25°C

FREQUENCY CHARACTERISTICS

ATTENUATION

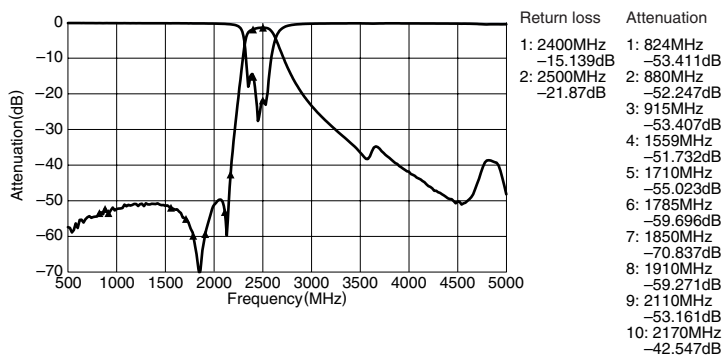

INSERTION LOSS

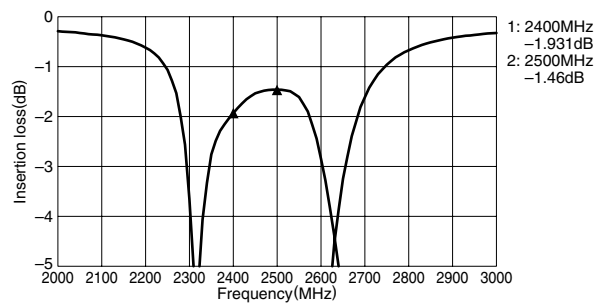

• All specifications are subject to change without notice.

Multilayer Chip Band Pass Filters For Bluetooth & 2.4GHz W-LAN

Conformity to RoHS Directive

DEA Series DEA252450BT-2109C3

SHAPES AND DIMENSIONS

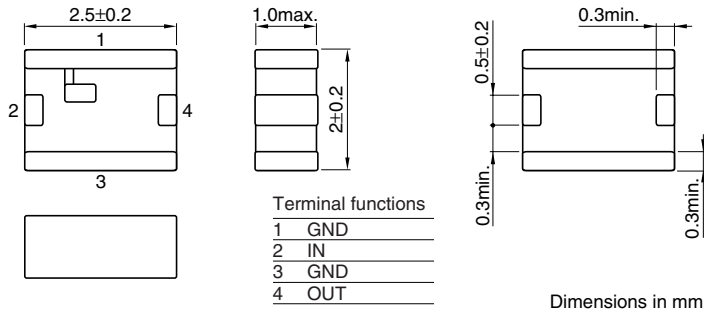

RECOMMENDED PC BOARD PATTERNS

LAND

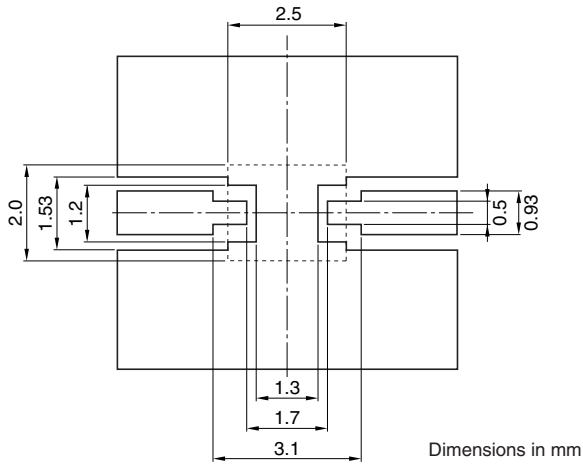

SOLDER RESIST

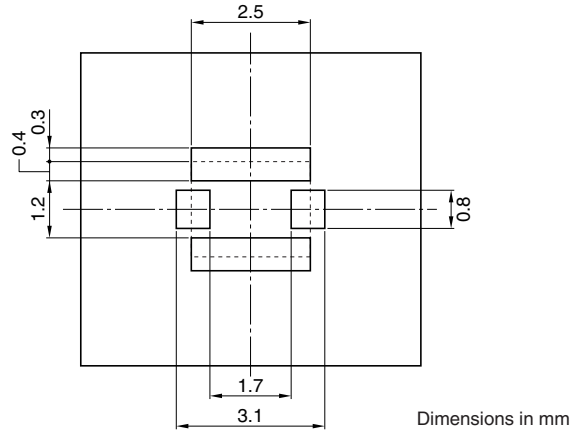

Line width be designed to match 50Ω characteristic impedance, depending on PCB material and thickness.

• Conformity to RoHS Directive: This means that, in conformity with EU Directive 2002/95/EC, lead, cadmium, mercury, hexavalent chromium, and specific bromine-based flame retardants, PBB and PBDE, have not been used, except for exempted applications.

• All specifications are subject to change without notice.

ELECTRICAL CHARACTERISTICS

Item		Minimum value	Typical value	Maximum value	
Frequency range(Pass band)	(MHz)	2400	—	2500	
Characteristic impedance(Pass band)	(Ω)	—	50[Nominal]	—	
Insertion loss(Pass band)	[+25°C]	—	—	2.3	
	[-40 to +85°C]	—	—	2.5	
Return loss(Pass band)	(dB)	10	—	—	
	[DC to 76MHz]	(dB)	45	—	—
	[76 to 108MHz]	(dB)	45	—	—
	[480MHz]	(dB)	45	—	—
	[746 to 764MHz]	(dB)	45	—	—
	[776 to 794MHz]	(dB)	45	—	—
	[824 to 849MHz]	(dB)	45	—	—
	[869 to 880MHz]	(dB)	45	—	—
	[880 to 915MHz]	(dB)	45	—	—
	[925 to 960MHz]	(dB)	45	—	—
	[1570 to 1580MHz]	(dB)	43	—	—
	[1710 to 1785MHz]	(dB)	44	—	—
	[1805 to 1850MHz]	(dB)	40	—	—
	[1850 to 1910MHz]	(dB)	40	—	—
	[1920 to 1980MHz]	(dB)	38	—	—
	[1980 to 1990MHz]	(dB)	38	—	—
	[2110 to 2170MHz]	(dB)	30	—	—
[2750 to 3000MHz]	(dB)	5	—	—	
[3000 to 4800MHz]	(dB)	15	—	—	
[4800 to 5000MHz]	(dB)	30	—	—	
[5150 to 5850MHz]	(dB)	30	—	—	
[7200 to 7500MHz]	(dB)	20	—	—	
Temperature range	Operating	(°C)	-40	+85	
	Storage	(°C)	-40	+85	

• Ta:+25°C

FREQUENCY CHARACTERISTICS

INSERTION LOSS

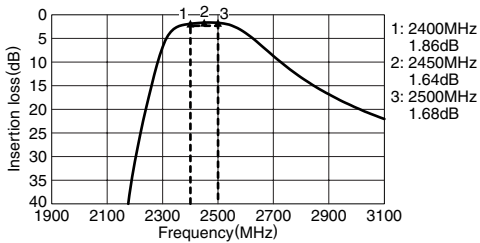

ATTENUATION

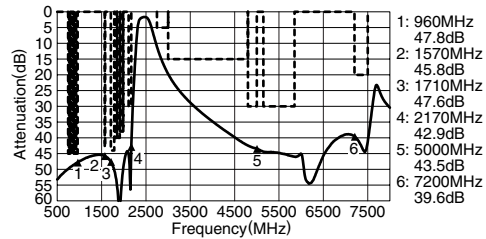

RETURN LOSS

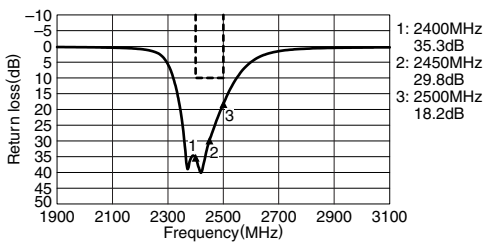

VSWR

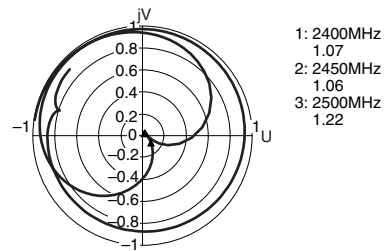

• All specifications are subject to change without notice.

Multilayer Chip Band Pass Filters For Bluetooth & 2.4GHz W-LAN

Conformity to RoHS Directive

DEA Series DEA252450BT-2037C1

SHAPES AND DIMENSIONS

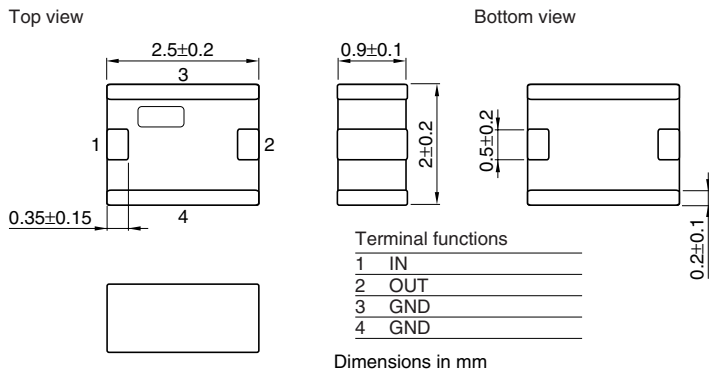

RECOMMENDED PC BOARD PATTERNS

LAND

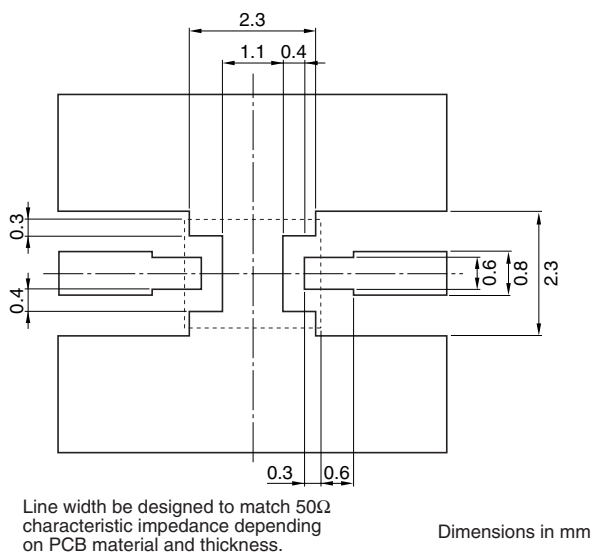

SOLDER RESIST

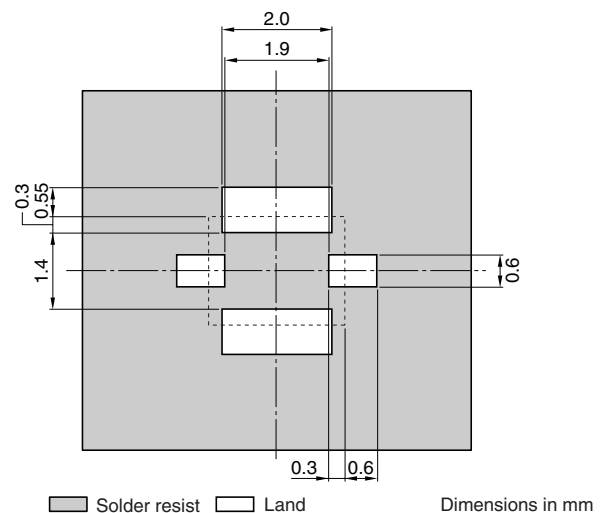

ELECTRICAL CHARACTERISTICS

Item		Minimum value	Typical value	Maximum value
Center frequency	[2450MHz]			
Insertion loss	[2400 to 2500MHz]	(dB) —	—	3
Return loss	[2400 to 2500MHz]	(dB) 10	—	—
Attenuation	[880 to 915MHz]	(dB) 43	—	—
	[1710 to 1990MHz]	(dB) 24	—	—
	[2110 to 2170MHz]	(dB) 14	—	—
	[2700MHz]	(dB) 25	—	—
Temperature range	Operating	(°C) -40	—	+85
	Storage	(°C) -40	—	+85

• Ta: +25°C

• Conformity to RoHS Directive: This means that, in conformity with EU Directive 2002/95/EC, lead, cadmium, mercury, hexavalent chromium, and specific bromine-based flame retardants, PBB and PBDE, have not been used, except for exempted applications.

• All specifications are subject to change without notice.

FREQUENCY CHARACTERISTICS

INSERTION LOSS

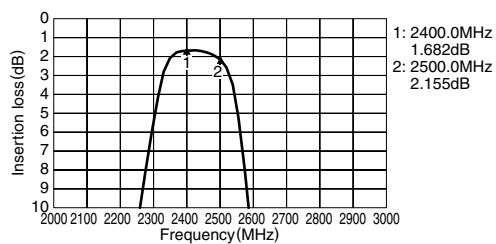

ATTENUATION

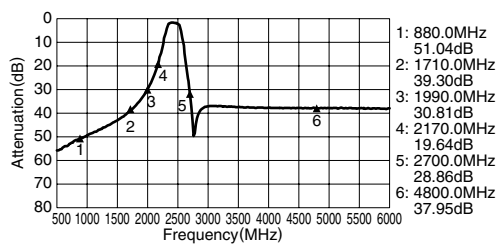

RETURN LOSS

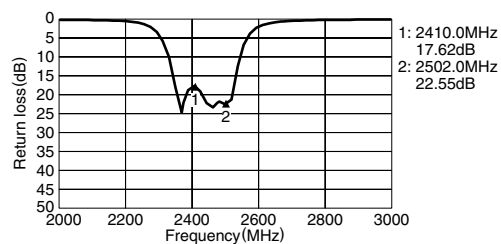

VSWR

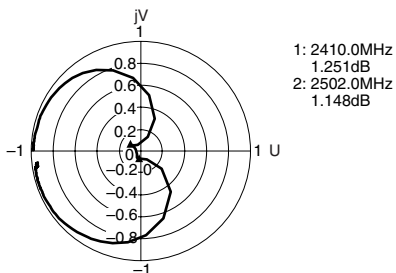

• All specifications are subject to change without notice.