

# Inductors for Standard Circuits

Wound Ferrite

**NLV-EFD Series (For automobiles)**

## NLV32-EFD Type

---

**NLV32-EFD**

**3225 [1210 inch]\***

\* Dimensions Code JIS[EIA]

## REMINDERS FOR USING THESE PRODUCTS

Before using these products, be sure to request the delivery specifications.

### SAFETY REMINDERS

Please pay sufficient attention to the warnings for safe designing when using these products.

#### REMINDERS

- The storage period is less than 6 months. Be sure to follow the storage conditions (Temperature: 5 to 40°C, Humidity: 10 to 75% RH or less).  
If the storage period elapses, the soldering of the terminal electrodes may deteriorate.
- Do not use or store in locations where there are conditions such as gas corrosion (salt, acid, alkali, etc.).
- Before soldering, be sure to preheat components.  
The preheating temperature should be set so that the temperature difference between the solder temperature and chip temperature does not exceed 150°C.
- Soldering corrections after mounting should be within the range of the conditions determined in the specifications.  
If overheated, a short circuit, performance deterioration, or lifespan shortening may occur.
- When embedding a printed circuit board where a chip is mounted to a set, be sure that residual stress is not given to the chip due to the overall distortion of the printed circuit board and partial distortion such as at screw tightening portions.
- Self heating (temperature increase) occurs when the power is turned ON, so the tolerance should be sufficient for the set thermal design.
- Carefully lay out the coil for the circuit board design of the non-magnetic shield type.  
A malfunction may occur due to magnetic interference.
- Use a wrist band to discharge static electricity in your body through the grounding wire.
- Do not expose the products to magnets or magnetic fields.
- Do not use for a purpose outside of the contents regulated in the delivery specifications.
- The products listed on this catalog are intended for use in general electronic equipment (AV equipment, telecommunications equipment, home appliances, amusement equipment, computer equipment, personal equipment, office equipment, measurement equipment, industrial robots) under a normal operation and use condition.  
The products are not designed or warranted to meet the requirements of the applications listed below, whose performance and/or quality require a more stringent level of safety or reliability, or whose failure, malfunction or trouble could cause serious damage to society, person or property.  
If you intend to use the products in the applications listed below or if you have special requirements exceeding the range or conditions set forth in the each catalog, please contact us.

- (1) Aerospace/Aviation equipment
- (2) Transportation equipment (electric trains, ships, etc.)
- (3) Medical equipment
- (4) Power-generation control equipment
- (5) Atomic energy-related equipment
- (6) Seabed equipment
- (7) Transportation control equipment

- (8) Public information-processing equipment
- (9) Military equipment
- (10) Electric heating apparatus, burning equipment
- (11) Disaster prevention/crime prevention equipment
- (12) Safety equipment
- (13) Other applications that are not considered general-purpose applications

When designing your equipment even for general-purpose applications, you are kindly requested to take into consideration securing protection circuit/device or providing backup circuits in your equipment.

# Inductors for Standard Circuits

## Wound Ferrite

Product compatible with RoHS directive  
Halogen-free  
Compatible with lead-free solders  
AEC-Q200

# Overview of NLV32-EFD Type

## FEATURES

- Resin mold type wound inductor for standard circuits.
- E-12 Series, wide lineup compatible with J ( $\pm 5\%$ ) tolerance, can be used for applications that need to meet strict L tolerance such as filter circuits.
- Has excellent inductance temperature characteristics in the operating temperature range.

## APPLICATION

Vehicle accessories (car navigation systems, car audio, ETC)

## PART NUMBER CONSTRUCTION

NLV		32		T		-		010		-		J		-		EFD	
Series name		LxWxH Dimensions (mm)		Packaging style				Inductance ( $\mu\text{H}$ )				Inductance tolerance				Internal code	
		32	3.2x2.5x2.2	T	Taping			010	0.01			J	$\pm 5\%$			EFD	Compatible with the RoHS Directive
								R10	0.1								
								1R0	1								
								100	10								
								101	100								

## OPERATING TEMPERATURE RANGE, PACKAGE QUANTITY, PRODUCT WEIGHT

Type	Temperature range		Package quantity (pieces/reel)	Individual weight (mg)
	Operating temperature* (°C)	Storage temperature** (°C)		
NLV32-EFD	-40 to +105	-40 to +105	2000	50

\* Operating temperature range includes self-temperature rise.

\*\* The Storage temperature range is for after the circuit board is mounted.

○ RoHS Directive Compliant Product: See the following for more details. <https://product.tdk.com/info/en/environment/rohs/index.html>

○ Halogen-free: Indicates that Cl content is less than 900ppm, Br content is less than 900ppm, and that the total Cl and Br content is less than 1500ppm.

 Please be sure to request delivery specifications that provide further details on the features and specifications of the products for proper and safe use.  
Please note that the contents may change without any prior notice due to reasons such as upgrading.

# NLV32-EFD Type

## RECOMMENDED REFLOW PROFILE

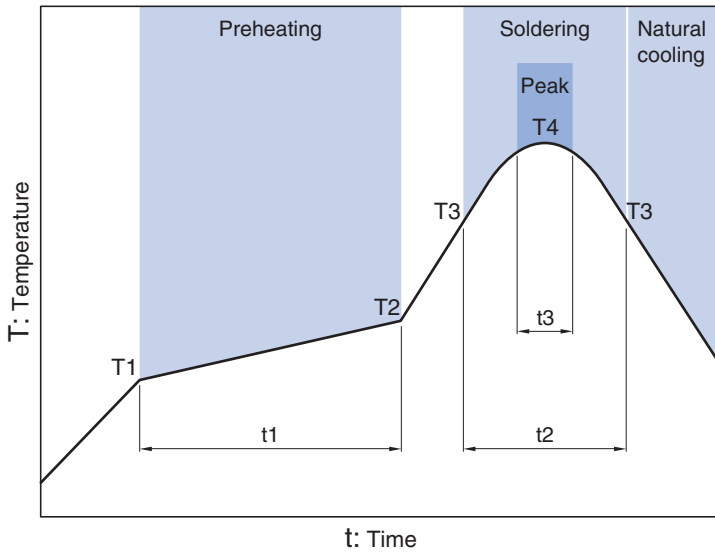

Preheating			Soldering		Peak	
Temp.	Temp.	Time	Temp.	Time	Temp.	Time
T1	T2	t1	T3	t2	T4	t3
150°C	180°C	90 to 120s	230°C	40s	255°C	10s max.

 Please be sure to request delivery specifications that provide further details on the features and specifications of the products for proper and safe use. Please note that the contents may change without any prior notice due to reasons such as upgrading.

# NLV32-EFD Type

## SHAPE & DIMENSIONS

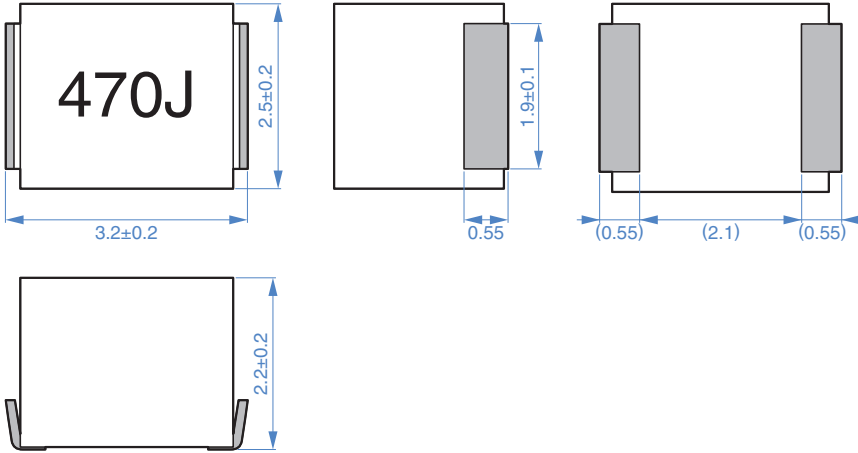

Dimensions in mm

## RECOMMENDED LAND PATTERN

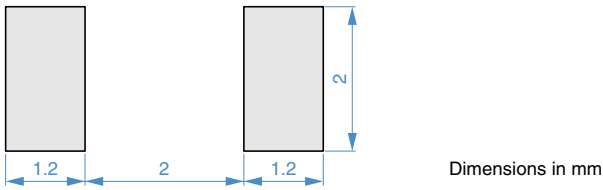

Dimensions in mm

 Please be sure to request delivery specifications that provide further details on the features and specifications of the products for proper and safe use. Please note that the contents may change without any prior notice due to reasons such as upgrading.

# NLV32-EFD Type

## ELECTRICAL CHARACTERISTICS

### CHARACTERISTICS SPECIFICATION TABLE

L	Q	L, Q measuring frequency	Self-resonant frequency	DC resistance	Rated current*	Part No.	
( $\mu\text{H}$ )	Tolerance	min. (MHz)	(MHz)min.	( $\Omega$ )max.	(mA)max.		
0.01	$\pm 5\%$	15	100	2500	0.13	450	NLV32T-010J-EFD
0.012	$\pm 5\%$	17	100	2300	0.14	450	NLV32T-012J-EFD
0.015	$\pm 5\%$	19	100	2100	0.16	450	NLV32T-015J-EFD
0.018	$\pm 5\%$	21	100	1900	0.18	450	NLV32T-018J-EFD
0.022	$\pm 5\%$	23	100	1700	0.2	450	NLV32T-022J-EFD
0.027	$\pm 5\%$	23	100	1500	0.22	450	NLV32T-027J-EFD
0.033	$\pm 5\%$	25	100	1400	0.24	450	NLV32T-033J-EFD
0.039	$\pm 5\%$	25	100	1300	0.27	450	NLV32T-039J-EFD
0.047	$\pm 5\%$	26	100	1200	0.3	450	NLV32T-047J-EFD
0.056	$\pm 5\%$	26	100	1100	0.33	450	NLV32T-056J-EFD
0.068	$\pm 5\%$	27	100	1000	0.36	450	NLV32T-068J-EFD
0.082	$\pm 5\%$	27	100	900	0.4	450	NLV32T-082J-EFD
0.1	$\pm 5\%$	28	100	700	0.44	450	NLV32T-R10J-EFD
0.12	$\pm 5\%$	30	25.2	500	0.22	450	NLV32T-R12J-EFD
0.15	$\pm 5\%$	30	25.2	450	0.25	450	NLV32T-R15J-EFD
0.18	$\pm 5\%$	30	25.2	400	0.28	450	NLV32T-R18J-EFD
0.22	$\pm 5\%$	30	25.2	350	0.32	450	NLV32T-R22J-EFD
0.27	$\pm 5\%$	30	25.2	320	0.36	450	NLV32T-R27J-EFD
0.33	$\pm 5\%$	30	25.2	300	0.4	450	NLV32T-R33J-EFD
0.39	$\pm 5\%$	30	25.2	250	0.45	450	NLV32T-R39J-EFD
0.47	$\pm 5\%$	30	25.2	220	0.5	450	NLV32T-R47J-EFD
0.56	$\pm 5\%$	30	25.2	180	0.55	450	NLV32T-R56J-EFD
0.68	$\pm 5\%$	30	25.2	160	0.6	450	NLV32T-R68J-EFD
0.82	$\pm 5\%$	30	25.2	140	0.65	450	NLV32T-R82J-EFD
1	$\pm 5\%$	30	7.96	120	0.7	400	NLV32T-1R0J-EFD
1.2	$\pm 5\%$	30	7.96	100	0.75	390	NLV32T-1R2J-EFD
1.5	$\pm 5\%$	30	7.96	85	0.85	370	NLV32T-1R5J-EFD
1.8	$\pm 5\%$	30	7.96	80	0.9	350	NLV32T-1R8J-EFD
2.2	$\pm 5\%$	30	7.96	75	1	320	NLV32T-2R2J-EFD
2.7	$\pm 5\%$	30	7.96	70	1.1	290	NLV32T-2R7J-EFD
3.3	$\pm 5\%$	30	7.96	60	1.2	260	NLV32T-3R3J-EFD
3.9	$\pm 5\%$	30	7.96	55	1.3	250	NLV32T-3R9J-EFD
4.7	$\pm 5\%$	30	7.96	50	1.5	220	NLV32T-4R7J-EFD
5.6	$\pm 5\%$	30	7.96	45	1.6	200	NLV32T-5R6J-EFD
6.8	$\pm 5\%$	30	7.96	40	1.8	180	NLV32T-6R8J-EFD
8.2	$\pm 5\%$	30	7.96	35	2	170	NLV32T-8R2J-EFD

\* Rated current: smaller value of either  $I_{dc1}$  or  $I_{dc2}$ .

$I_{dc1}$ : When based on the inductance change rate (10% below the initial L value)

$I_{dc2}$ : When based on the temperature increase (Temperature increase of 20°C by self heating)

### Measurement equipment

Measurement item	Product No.	Manufacturer
L, Q	4191A+16092A 4194A+16085A+16093B	Keysight Technologies
Self-resonant frequency	8753C	Keysight Technologies
DC resistance	VP-2941A	Panasonic

\* Equivalent measurement equipment may be used.

# NLV32-EFD Type

## ELECTRICAL CHARACTERISTICS

### CHARACTERISTICS SPECIFICATION TABLE

L	Q	L, Q measuring frequency	Self-resonant frequency	DC resistance	Rated current*	Part No.	
( $\mu$ H)	Tolerance	min. (MHz)	(MHz)min.	( $\Omega$ )max.	(mA)max.		
10	$\pm 5\%$	30	2.52	30	2.1	150	NLV32T-100J-EFD
12	$\pm 5\%$	30	2.52	20	2.5	140	NLV32T-120J-EFD
15	$\pm 5\%$	30	2.52	20	2.8	130	NLV32T-150J-EFD
18	$\pm 5\%$	30	2.52	20	3.3	120	NLV32T-180J-EFD
22	$\pm 5\%$	30	2.52	20	3.7	110	NLV32T-220J-EFD
27	$\pm 5\%$	30	2.52	20	5	80	NLV32T-270J-EFD
33	$\pm 5\%$	30	2.52	17	5.6	70	NLV32T-330J-EFD
39	$\pm 5\%$	30	2.52	16	6.4	65	NLV32T-390J-EFD
47	$\pm 5\%$	30	2.52	15	7	60	NLV32T-470J-EFD
56	$\pm 5\%$	30	2.52	13	8	55	NLV32T-560J-EFD
68	$\pm 5\%$	30	2.52	12	9	50	NLV32T-680J-EFD
82	$\pm 5\%$	30	2.52	11	10	45	NLV32T-820J-EFD
100	$\pm 5\%$	20	0.796	10	10	40	NLV32T-101J-EFD
120	$\pm 5\%$	20	0.796	10	11	70	NLV32T-121J-EFD
150	$\pm 5\%$	20	0.796	8	15	65	NLV32T-151J-EFD
180	$\pm 5\%$	20	0.796	7	17	60	NLV32T-181J-EFD
220	$\pm 5\%$	20	0.796	7	21	50	NLV32T-221J-EFD
270	$\pm 5\%$	20	0.796	6	28	45	NLV32T-271J-EFD
330	$\pm 5\%$	20	0.796	5	34	40	NLV32T-331J-EFD
390	$\pm 5\%$	20	0.796	5	36	35	NLV32T-391J-EFD
470	$\pm 5\%$	20	0.796	4	40	25	NLV32T-471J-EFD

\* Rated current: smaller value of either I<sub>dc1</sub> or I<sub>dc2</sub>.

I<sub>dc1</sub>: When based on the inductance change rate (10% below the initial L value)

I<sub>dc2</sub>: When based on the temperature increase (Temperature increase of 20°C by self heating)

#### Measurement equipment

Measurement item	Product No.	Manufacturer
L, Q	4191A+16092A 4194A+16085A+16093B	Keysight Technologies
Self-resonant frequency	8753C	Keysight Technologies
DC resistance	VP-2941A	Panasonic

\* Equivalent measurement equipment may be used.

# NLV32-EFD Type

## ELECTRICAL CHARACTERISTICS

### L FREQUENCY CHARACTERISTICS GRAPH

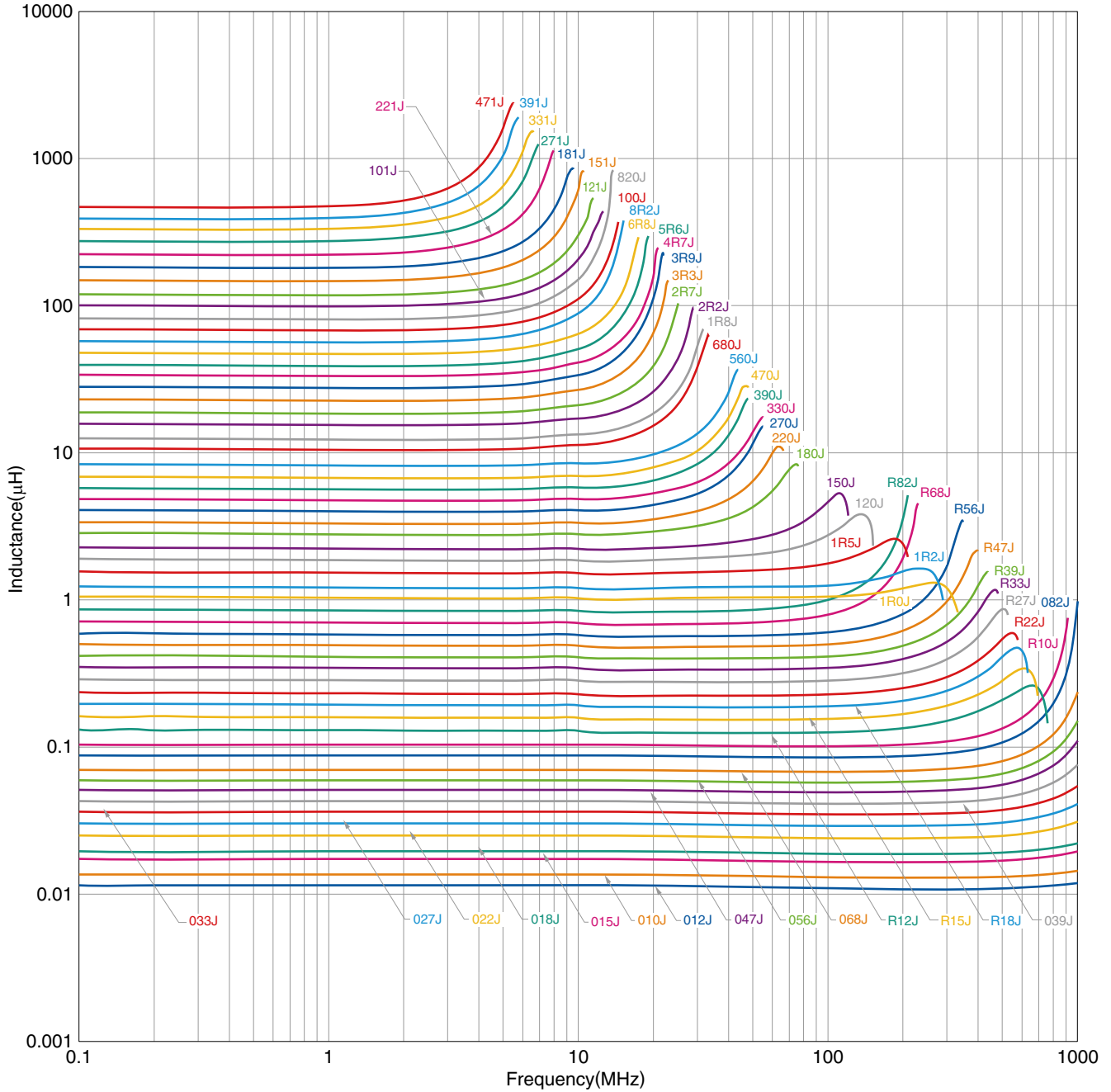

○ Measurement equipment

Product No.	Manufacturer
4291A	Keysight Technologies
4294A	Keysight Technologies

\* Equivalent measurement equipment may be used.

 Please be sure to request delivery specifications that provide further details on the features and specifications of the products for proper and safe use.  
Please note that the contents may change without any prior notice due to reasons such as upgrading.





# NLV32-EFD Type

## PACKAGING STYLE

### REEL DIMENSIONS



Type	A	W1	W2	N	E
NLV32-EFD	ø180	9	13	ø60	0.5

\* These values are typical values.

### TAPE DIMENSIONS

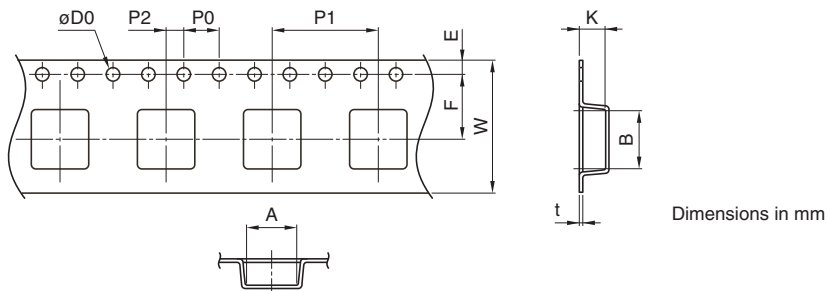

Type	A	B	øD0	E	F	P0	P1	P2	W	K	t
NLV32-EFD	2.8	3.5	1.5+0.1/-0	1.75±0.1	3.50±0.05	4.00±0.10	4.00±0.10	2.00±0.05	8.00±0.30	2.3	0.4