



Inductors for Standard Circuits

Multilayer Ferrite

MLF Series

MLF1608 Type

MLF1608

1608 [0603 inch]*

* Dimensions Code JIS[EIA]

REMINDERS FOR USING THESE PRODUCTS

Before using these products, be sure to request the delivery specifications.

SAFETY REMINDERS

Please pay sufficient attention to the warnings for safe designing when using these products.

REMINDERS

- The storage period is less than 12 months. Be sure to follow the storage conditions (Temperature: 5 to 40°C, Humidity: 10 to 75% RH or less).
If the storage period elapses, the soldering of the terminal electrodes may deteriorate.
- Do not use or store in locations where there are conditions such as gas corrosion (salt, acid, alkali, etc.).
- Before soldering, be sure to preheat components.
The preheating temperature should be set so that the temperature difference between the solder temperature and chip temperature does not exceed 150°C.
- Soldering corrections after mounting should be within the range of the conditions determined in the specifications.
If overheated, a short circuit, performance deterioration, or lifespan shortening may occur.
- When embedding a printed circuit board where a chip is mounted to a set, be sure that residual stress is not given to the chip due to the overall distortion of the printed circuit board and partial distortion such as at screw tightening portions.
- Self heating (temperature increase) occurs when the power is turned ON, so the tolerance should be sufficient for the set thermal design.
- Carefully lay out the coil for the circuit board design of the non-magnetic shield type.
A malfunction may occur due to magnetic interference.
- Use a wrist band to discharge static electricity in your body through the grounding wire.
- Do not expose the products to magnets or magnetic fields.
- Do not use for a purpose outside of the contents regulated in the delivery specifications.
- The products listed on this catalog are intended for use in general electronic equipment (AV equipment, telecommunications equipment, home appliances, amusement equipment, computer equipment, personal equipment, office equipment, measurement equipment, industrial robots) under a normal operation and use condition.
The products are not designed or warranted to meet the requirements of the applications listed below, whose performance and/or quality require a more stringent level of safety or reliability, or whose failure, malfunction or trouble could cause serious damage to society, person or property.
If you intend to use the products in the applications listed below or if you have special requirements exceeding the range or conditions set forth in the each catalog, please contact us.

- (1) Aerospace/Aviation equipment
- (2) Transportation equipment (cars, electric trains, ships, etc.)
- (3) Medical equipment
- (4) Power-generation control equipment
- (5) Atomic energy-related equipment
- (6) Seabed equipment
- (7) Transportation control equipment

- (8) Public information-processing equipment
- (9) Military equipment
- (10) Electric heating apparatus, burning equipment
- (11) Disaster prevention/crime prevention equipment
- (12) Safety equipment
- (13) Other applications that are not considered general-purpose applications

When designing your equipment even for general-purpose applications, you are kindly requested to take into consideration securing protection circuit/device or providing backup circuits in your equipment.

Inductors for Standard Circuits

Multilayer Ferrite

Product compatible with RoHS directive
Halogen-free
Compatible with lead-free solders

Overview of MLF1608 Type

FEATURES

- The lineup includes a wide inductance range.
- Highly reliable monolithic structure with multilayer integration.

APPLICATION

Smart phones, tablet terminals, tuners, LCD-TVs, PDP-TVs, audio equipment, computers, signal processing for modules etc.

PART NUMBER CONSTRUCTION

MLF	1608		D	47N		△	T		000
Series name	L×W×H Dimensions (mm)		characteristics	Inductance (μH)		Inductance tolerance		Packaging style	Internal code
	1608	1.6×0.8×0.8	A		0.010	J	±5%	T	000
			C	10N	(10nH)	K	±10%		A00
			D	R10	0.1	M	±20%		D00
			E	1R0	1				

OPERATING TEMPERATURE RANGE, PACKAGE QUANTITY, PRODUCT WEIGHT

Type	Temperature range*		Package quantity (pieces/reel)	Individual weight (mg)
	Operating temperature (°C)	Storage temperature** (°C)		
MLF1608	-55 to +125	-55 to +125	4,000	4

* In case the product's inductance is 15μH or higher, both Operating and Storage temperature ranges are -40 to +85°C.

** The Storage temperature range is for after the circuit board is mounted.

- RoHS Directive Compliant Product: See the following for more details. <https://product.tdk.com/info/en/environment/rohs/index.html>
- Halogen-free: Indicates that Cl content is less than 900ppm, Br content is less than 900ppm, and that the total Cl and Br content is less than 1500ppm.

 Please be sure to request delivery specifications that provide further details on the features and specifications of the products for proper and safe use. Please note that the contents may change without any prior notice due to reasons such as upgrading.

MLF1608 Type

RECOMMENDED REFLOW PROFILE

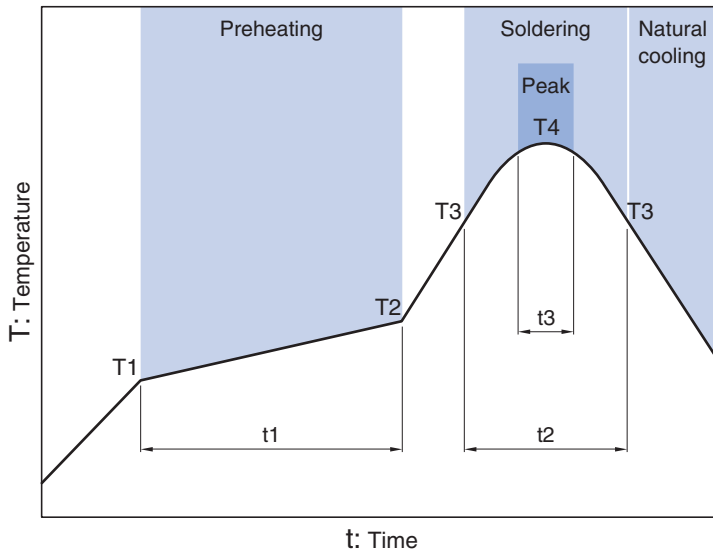

Preheating			Soldering		Peak	
Temp.	Temp.	Time	Temp.	Time	Temp.	Time
T1	T2	t1	T3	t2	T4	t3
150°C	180°C	60 to 120s	230°C	30 to 60s	250 to 260°C	10s max.

MLF1608 Type

■ SHAPE & DIMENSIONS

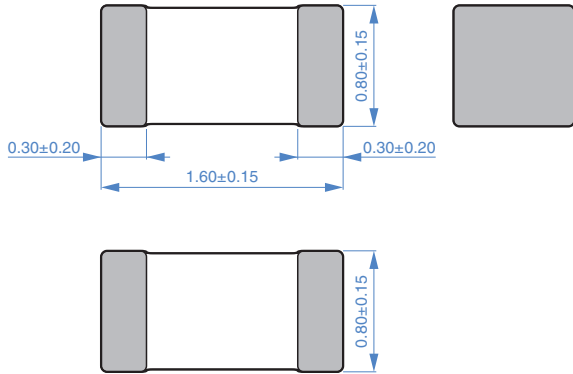

Dimensions in mm

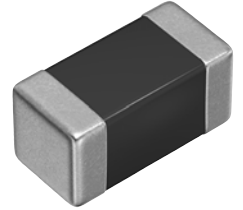

■ RECOMMENDED LAND PATTERN

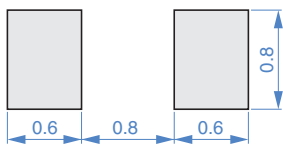

Dimensions in mm

MLF1608 Type

ELECTRICAL CHARACTERISTICS

CHARACTERISTICS SPECIFICATION TABLE

L	Q	L, Q measuring conditions		Self-resonant frequency		DC resistance		Rated current		Part No.*	
		Frequency	Current	(MHz)	(mA)	(MHz)min.	(MHz)typ.	(Ω)max.	(Ω)typ.		(mA)max.
(μ H)	Tolerance	min.	typ.	(MHz)	(mA)	(MHz)min.	(MHz)typ.	(Ω)max.	(Ω)typ.	(mA)max.	
0.047	$\pm 20\%$	10	20	50	1.0	600	900	0.20	0.10	200	MLF1608D47N Δ T□□□
0.068	$\pm 20\%$	10	20	50	1.0	550	700	0.30	0.15	200	MLF1608D68N Δ T□□□
0.082	$\pm 20\%$	10	20	50	1.0	500	650	0.30	0.15	200	MLF1608D82N Δ T□□□
0.10	$\pm 5\% \pm 10\% \pm 20\%$	15	25	25	1.0	450	600	0.35	0.20	200	MLF1608DR10 Δ T□□□
0.12	$\pm 5\% \pm 10\% \pm 20\%$	15	25	25	1.0	400	550	0.40	0.20	200	MLF1608DR12 Δ T□□□
0.15	$\pm 5\% \pm 10\% \pm 20\%$	15	25	25	1.0	350	500	0.45	0.25	200	MLF1608DR15 Δ T□□□
0.18	$\pm 5\% \pm 10\% \pm 20\%$	15	25	25	1.0	320	450	0.50	0.25	150	MLF1608DR18 Δ T□□□
0.22	$\pm 5\% \pm 10\% \pm 20\%$	15	25	25	1.0	290	400	0.55	0.30	150	MLF1608DR22 Δ T□□□
0.27	$\pm 5\% \pm 10\% \pm 20\%$	15	25	25	1.0	260	350	0.60	0.35	150	MLF1608DR27 Δ T□□□
0.33	$\pm 5\% \pm 10\% \pm 20\%$	15	25	25	1.0	230	320	0.75	0.40	100	MLF1608DR33 Δ T□□□
0.39	$\pm 5\% \pm 10\% \pm 20\%$	15	25	25	1.0	210	290	0.85	0.45	100	MLF1608DR39 Δ T□□□
0.47	$\pm 5\% \pm 10\% \pm 20\%$	15	30	25	1.0	190	260	0.95	0.50	100	MLF1608DR47 Δ T□□□
0.56	$\pm 5\% \pm 10\% \pm 20\%$	15	30	25	1.0	170	230	1.05	0.55	100	MLF1608DR56 Δ T□□□
0.68	$\pm 5\% \pm 10\% \pm 20\%$	15	30	25	1.0	150	210	1.25	0.65	70	MLF1608DR68 Δ T□□□
0.82	$\pm 5\% \pm 10\% \pm 20\%$	15	30	25	1.0	130	190	1.40	0.75	70	MLF1608DR82 Δ T□□□
1.0	$\pm 5\% \pm 10\% \pm 20\%$	35	50	10	1.0	120	170	0.50	0.25	50	MLF1608A1R0 Δ T□□□
1.2	$\pm 5\% \pm 10\% \pm 20\%$	35	50	10	1.0	110	150	0.65	0.25	50	MLF1608A1R2 Δ T□□□
1.5	$\pm 5\% \pm 10\% \pm 20\%$	35	55	10	1.0	100	140	0.70	0.30	50	MLF1608A1R5 Δ T□□□
1.8	$\pm 5\% \pm 10\% \pm 20\%$	35	55	10	1.0	90	130	0.85	0.35	50	MLF1608A1R8 Δ T□□□
2.2	$\pm 5\% \pm 10\% \pm 20\%$	35	55	10	1.0	80	120	1.00	0.45	30	MLF1608A2R2 Δ T□□□
2.7	$\pm 5\% \pm 10\% \pm 20\%$	35	55	10	1.0	70	110	1.15	0.50	30	MLF1608A2R7 Δ T□□□
3.3	$\pm 5\% \pm 10\% \pm 20\%$	35	60	10	1.0	65	100	1.30	0.55	30	MLF1608A3R3 Δ T□□□
3.9	$\pm 5\% \pm 10\% \pm 20\%$	35	60	10	1.0	60	90	1.45	0.65	30	MLF1608A3R9 Δ T□□□
4.7	$\pm 5\% \pm 10\% \pm 20\%$	35	60	10	1.0	55	80	1.60	0.75	30	MLF1608A4R7 Δ T□□□
5.6	$\pm 5\% \pm 10\% \pm 20\%$	35	60	4	0.1	45	70	1.10	0.55	15	MLF1608E5R6 Δ T□□□
6.8	$\pm 5\% \pm 10\% \pm 20\%$	35	60	4	0.1	40	60	1.30	0.65	15	MLF1608E6R8 Δ T□□□
8.2	$\pm 5\% \pm 10\% \pm 20\%$	35	60	4	0.1	35	55	1.50	0.80	10	MLF1608E8R2 Δ T□□□
10	$\pm 5\% \pm 10\% \pm 20\%$	30	55	2	0.1	30	50	1.70	1.00	10	MLF1608E100 Δ T□□□
12	$\pm 5\% \pm 10\% \pm 20\%$	30	55	2	0.1	25	45	1.80	1.20	10	MLF1608E120 Δ T□□□
15	$\pm 10\% \pm 20\%$	20	40	1	0.1	22	42	1.50	0.80	2	MLF1608C150 Δ T□□□
18	$\pm 10\% \pm 20\%$	20	40	1	0.1	20	40	1.60	0.85	2	MLF1608C180 Δ T□□□
22	$\pm 10\% \pm 20\%$	20	40	1	0.1	18	38	1.70	0.90	2	MLF1608C220 Δ T□□□
27	$\pm 10\% \pm 20\%$	20	40	1	0.1	15	35	1.80	1.20	2	MLF1608C270 Δ T□□□
33	$\pm 10\% \pm 20\%$	20	40	1	0.1	10	30	2.20	1.40	2	MLF1608C330 Δ T□□□

* The " Δ " of the Part Number contains the inductance tolerance code, J ($\pm 5\%$), K ($\pm 10\%$), or M ($\pm 20\%$).

* The "□" of the Part Number contains the internal code (000, A00, or D00), following below.

- In case the inductance tolerance code is J: 000
- In case the inductance tolerance code is M or K (L = 0.047 to 8.2 μ H or 15 to 22 μ H): A00
- In case the inductance tolerance code is M or K (L = 10, 12, 27, 33 μ): D00

○ Measurement equipment

Measurement item	Product No.	Manufacturer
L, Q	4294A+16034G	Keysight Technologies
Self-resonant frequency	E4991A	Keysight Technologies
DC resistance	Type-7561	Yokogawa

* Equivalent measurement equipment may be used.

MLF1608 Type

ELECTRICAL CHARACTERISTICS

L FREQUENCY CHARACTERISTICS GRAPH

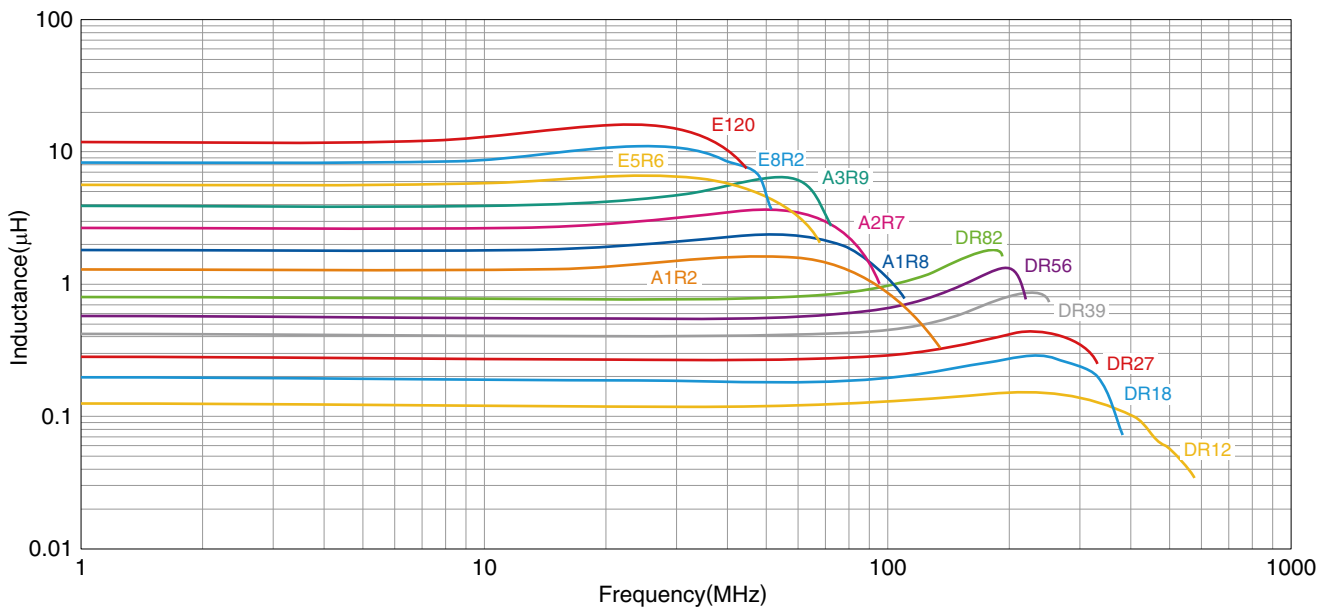
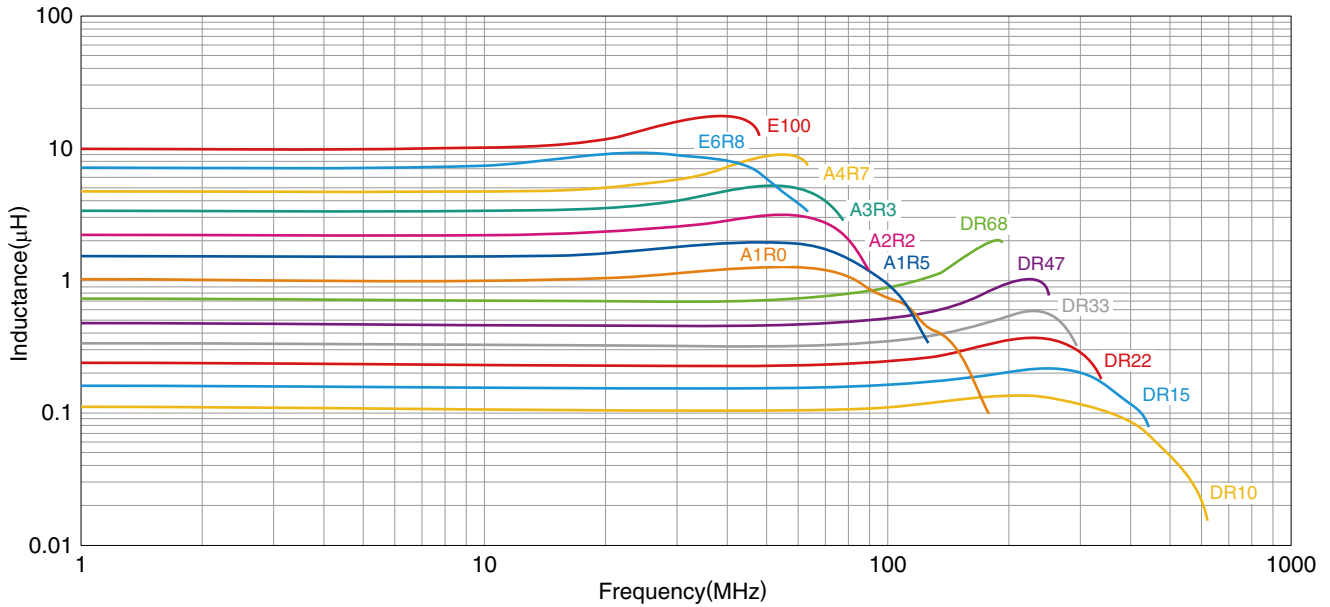

○ Measurement equipment

Product No.	Manufacturer
E4991A+16192A	Keysight Technologies

* Equivalent measurement equipment may be used.

⚠ Please be sure to request delivery specifications that provide further details on the features and specifications of the products for proper and safe use.
Please note that the contents may change without any prior notice due to reasons such as upgrading.

MLF1608 Type

ELECTRICAL CHARACTERISTICS

L FREQUENCY CHARACTERISTICS GRAPH

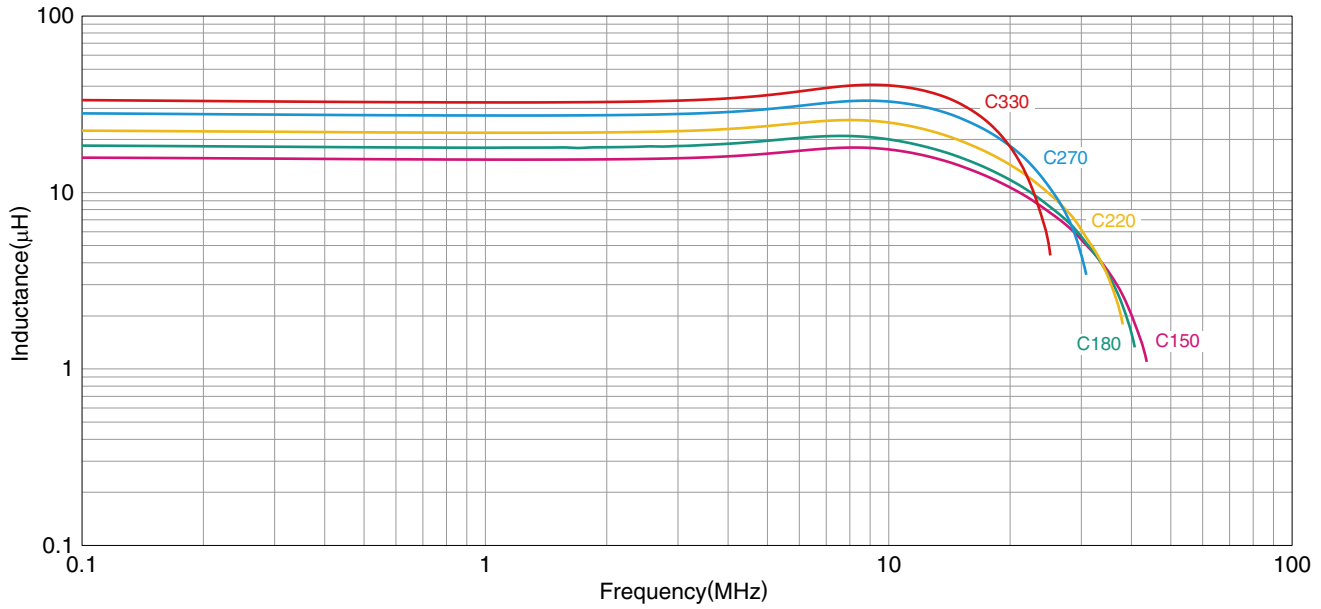

○ Measurement equipment

Product No.	Manufacturer
4294A+16034G	Keysight Technologies

* Equivalent measurement equipment may be used.

⚠ Please be sure to request delivery specifications that provide further details on the features and specifications of the products for proper and safe use.
Please note that the contents may change without any prior notice due to reasons such as upgrading.

MLF1608 Type

ELECTRICAL CHARACTERISTICS

Q FREQUENCY CHARACTERISTICS GRAPH

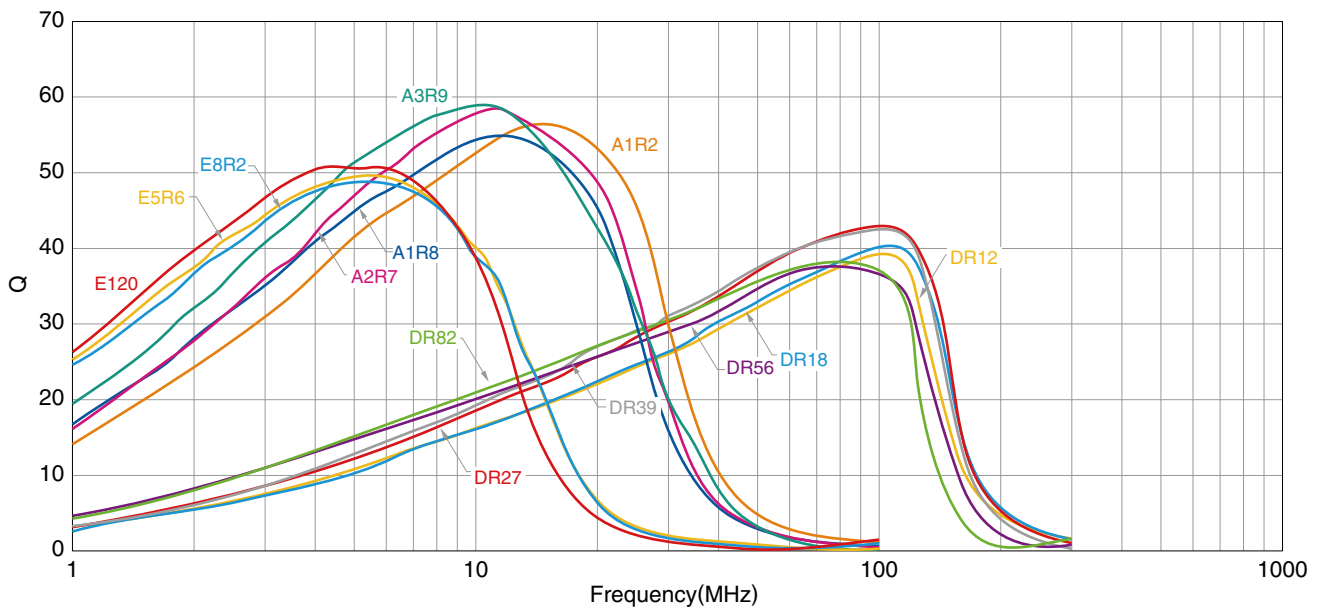
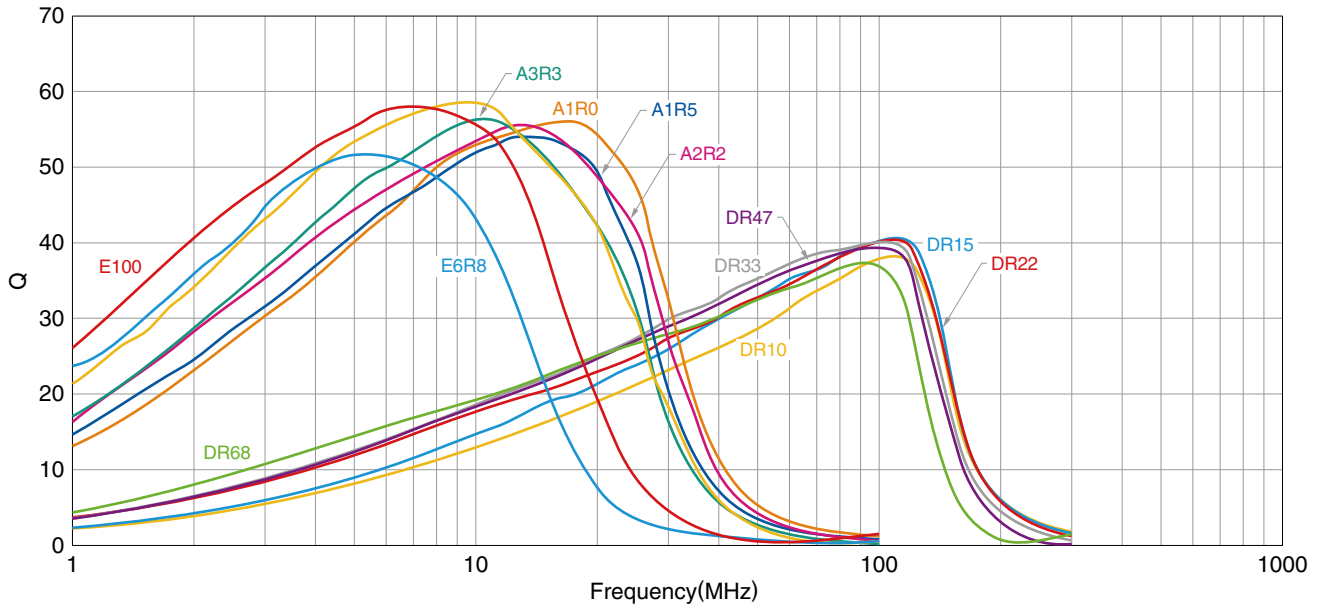

○ Measurement equipment

Product No.	Manufacturer
E4991A+16192A	Keysight Technologies

* Equivalent measurement equipment may be used.

⚠ Please be sure to request delivery specifications that provide further details on the features and specifications of the products for proper and safe use.
Please note that the contents may change without any prior notice due to reasons such as upgrading.

MLF1608 Type

ELECTRICAL CHARACTERISTICS

Q FREQUENCY CHARACTERISTICS GRAPH

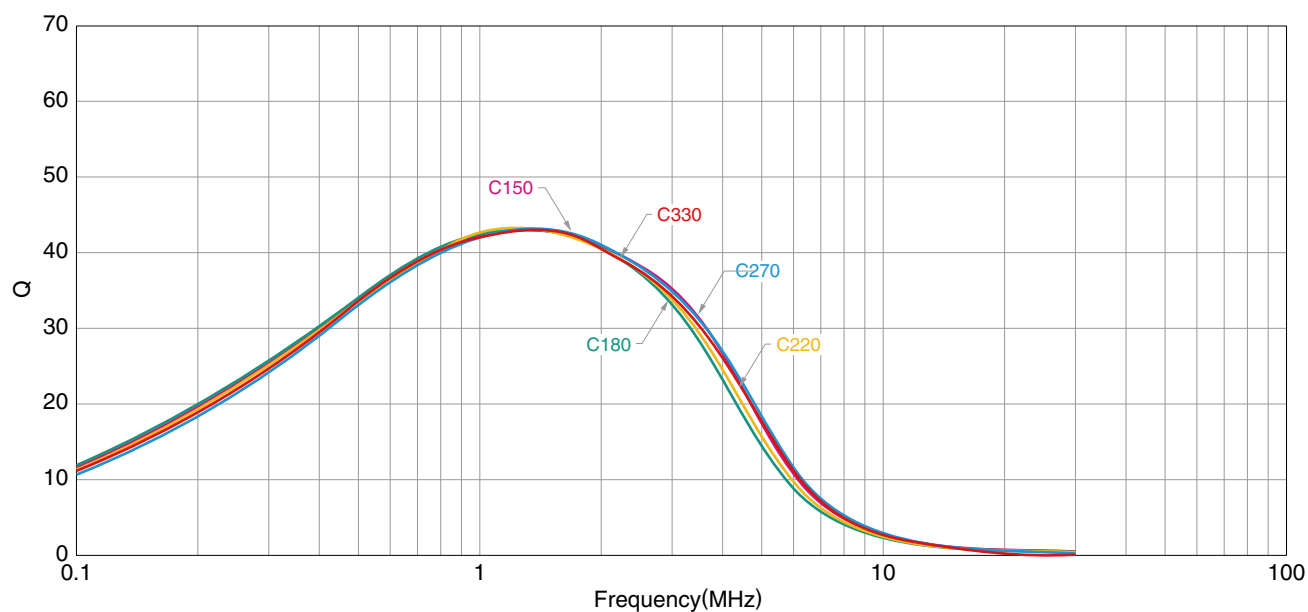

○ Measurement equipment

Product No.	Manufacturer
4294A+16034G	Keysight Technologies

* Equivalent measurement equipment may be used.

MLF1608 Type

PACKAGING STYLE

REEL DIMENSIONS

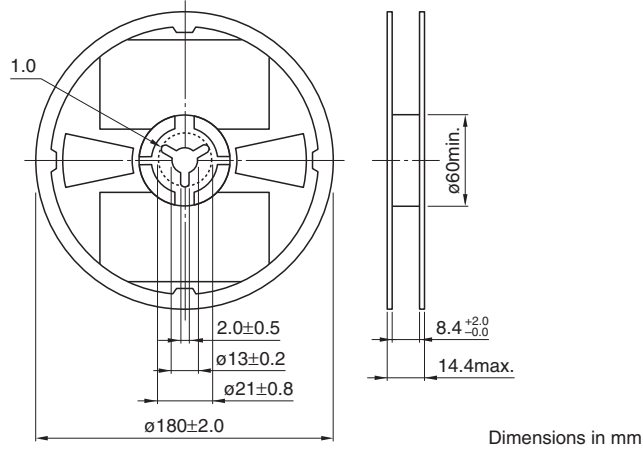

TAPE DIMENSIONS

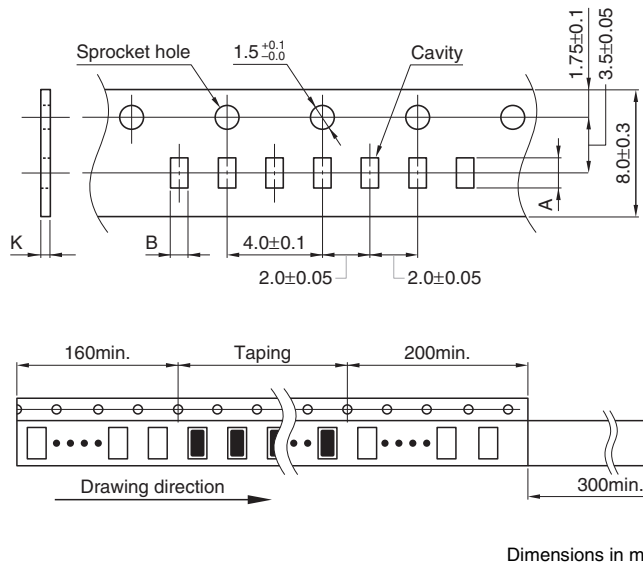

Type	A	B	K
MLF1608	1.9±0.2	1.1±0.2	1.1 max.

⚠ Please be sure to request delivery specifications that provide further details on the features and specifications of the products for proper and safe use.
Please note that the contents may change without any prior notice due to reasons such as upgrading.