

7 X 5 mm SMD CMOS CXO 7W SERIES

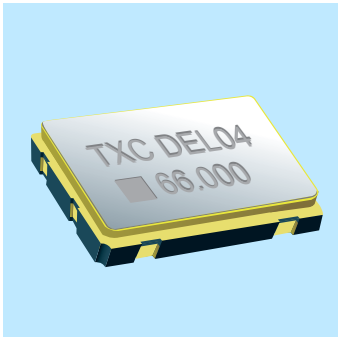

Features

- > Small SMD seam sealed clock crystal oscillator units.
- > High precision characteristic covering up to wide frequency range.
- > Designed for automatic mounting and reflow soldering.
- > Optionable stand-by function for output: Tri-state output.
- > Supply voltage range : 1.8 V ~ 5 V.
- > High stability, low jitter, low power consumption.
- > Main application : wireless communication, PC, and LCDM.
- > RoHS Compliant / Pb Free.

Electrical Specifications

Item / Type	7W		
Output Type	CMOS		
Output Load	15 pF	15 pF , 30 pF	15 pF , 50 pF
Oscillation Mode	Fundamental / 3rd Overtone		
Supply Voltage	1.8 V	2.5 V , 2.8 V , 3.3 V	5 V
Frequency Range	1 ~ 170 MHz		
Frequency Stability	± 50 ppm (-10 ~ + 70 °C), or specify		
Operating Temperature Range	- 40 ~ + 85 °C		
Storage Temperature Range	- 55 ~ + 125 °C		
Voltage Vol (Max.) / Voh (Min.)	0.1 VDD / 0.9 VDD		
Rise (Tr) / Fall (Tf) Time	10 ns (1 ~ 10 MHz) , 7 ns (20 ~ 50 MHz) , 5 ns (> 50 MHz) Max.		
Supply Current	20 mA Max.		
Symmetry	40 ~ 60 %		
Start-up Time	10 ms Max.		
Phase Jitter (12 KHz ~ 20 MHz)	1 ps Max.		
Aging (at 25 °C)	± 3 ppm / year Max.		

Dimensions

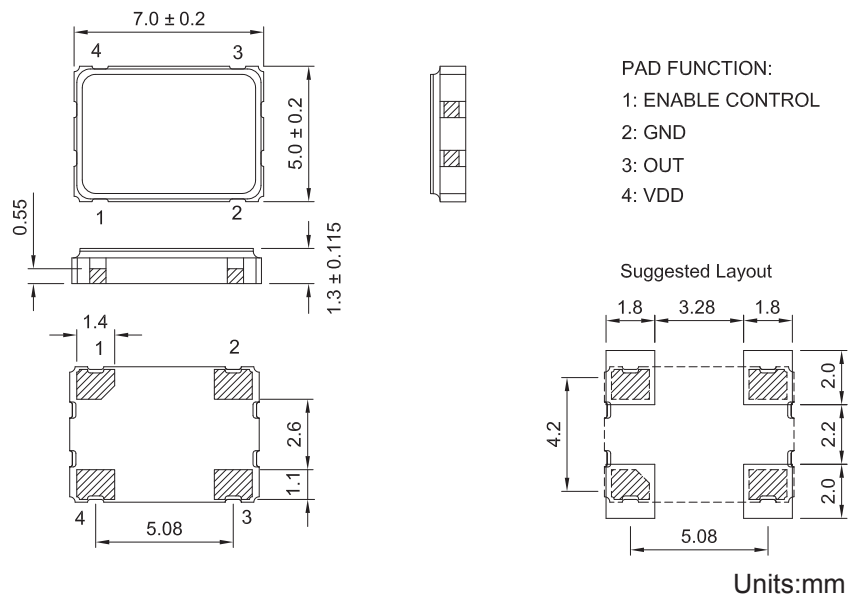

Remark : Specification subject to change without prior notice. Please confirm with our sales.