



## ABSOLUTE MAXIMUM RATINGS

Parameters	Symbol	Unit	Value	Comment
Supply voltage	V <sub>cc</sub>	V	7	
Primary conductor temperature	—	°C	110	
Non repetitive primary current pulse(20 μS) in powered or unpowered state.	I <sub>p</sub>	A	20 × I <sub>f</sub>	
ESD(HBM: Human Body Model)	—	kV	4	C=100pF, R=1.5kΩ

## ISOLATION CHARACTERISTICS

Parameters	Symbol	Unit	Value	Comment
Insulation voltage	V <sub>d</sub>	—	AC4200V, for 1minute(Sensing current 0.5mA)	Primary ↔ Secondary
Insulation Resistance	R <sub>is</sub>	—	≥ 500MΩ (at DC500V)	Primary ↔ Secondary
Clearance distance	d <sub>ci</sub>	—	7.7mm (TYP)	Primary ↔ Secondary
Creepage distance	d <sub>cp</sub>	—	7.7mm (TYP)	Primary ↔ Secondary
Case material	—	—	UL94 V-0	
Comparative Tracking Index (CTI)	CTI	V	600	
Application example	—	—	300V, CAT III, PD2	Reinforced isolation,non uniform field according to EN50178, EN61010
	—	—	600V, CAT III, PD2	Simple isolation,non uniform field according to EN50178, EN61010

## ENVIRONMENTAL AND MECHANICAL CHARACTERISTICS

Parameters	Symbol	Unit	Value			Comment
			MIN	TYP	MAX	
Ambient operating temperature	T <sub>a</sub>	°C	-40		+105	
Ambient storage temperature	T <sub>s</sub>	°C	-40		+105	
Mass	m	g		12		

SPECIFICATIONS

Parameters	Symbol	Unit	Value			Comment
			MIN	TYP	MAX	
Rated Current	F01P006S05	If	A		6	
	F01P015S05				15	
	F01P025S05				25	
	F01P050S05				50	
Maximum current (at Vcc=+5V, Ta=+105°C)	F01P006S05	I <sub>pmax</sub>	A	-20		20
	F01P015S05			-51		51
	F01P025S05			-85		85
	F01P050S05			-150		150
Supply Voltage	V <sub>cc</sub>	V	4.75	5.00	5.25	
Number of primary turns	N <sub>p</sub>	T	1, 2, 3			
Number of secondary turns	F01P006S05	N <sub>s</sub>	T		1816	
	F01P015S05				1737	
	F01P025S05				1764	
	F01P050S05				1600	
Consumption current (at If)	F01P006S05	I <sub>cc</sub>	mA		25	I <sub>cc</sub> =15+I <sub>p</sub> (mA)/N <sub>s</sub>
	F01P015S05				30	
	F01P025S05				35	
	F01P050S05				55	
Output voltage	V <sub>o</sub>	V	0.375		4.625	
Output voltage(at I <sub>o</sub> =0A)	V <sub>o</sub>	V		2.5		
Electrical offset voltage	F01P006S05	V <sub>oe</sub>	mV	-10.40		10.40
	F01P015S05			-7.10		7.10
	F01P025S05			-6.25		6.25
	F01P050S05			-5.80		5.80
Electrical offset current referred to primary	F01P006S05	I <sub>oe</sub>	A	-0.10		0.10
	F01P015S05			-0.17		0.17
	F01P025S05			-0.25		0.25
	F01P050S05			-0.46		0.46
Temperature coefficient of Output voltage(at I <sub>o</sub> =0A)	F01P006S05	TCV <sub>o</sub>	ppm/K		±10.0	±80.0
	F01P015S05				±7.5	±70.0
	F01P025S05				±6.5	±60.0
	F01P050S05				±6.0	±60.0
Sensitivity(Theoretical value)	F01P006S05	G <sub>th</sub>	mV/A		104.2	625mV/If
	F01P015S05				41.67	
	F01P025S05				25	
	F01P050S05				12.5	
Sensitivity error	ε <sub>G</sub>	%	-0.7		0.7	
Temperature coefficient of Sensitivity(at Ta=-40°C~+105°C)	TCG	ppm/K			±40	
Output Linearity	ε <sub>L</sub>	%	-0.1		0.1	
Magnetic offset current referred to primary(at 10×If)	I <sub>OM</sub>	A	-0.1		0.1	
Output current noise referred to primary(at 100Hz~100kHz)	F01P006S05	I <sub>no</sub>	μA/(Hz) <sup>1/2</sup>		36	RL=1kΩ
	F01P015S05				90	
	F01P025S05				150	
	F01P050S05				300	

Offset voltage value is after removal of core hysteresis.

SPECIFICATIONS

Ta=+25°C, RL=10kΩ, Vcc=+5V

Parameters	Symbol	Unit	Value			Comment	
			MIN	TYP	MAX		
Peak to peak output ripple at oscillator frequency(f typ=450kHz)	F01P006S05	—	mV		40	160	RL=1kΩ
	F01P015S05				15	60	
	F01P025S05				10	40	
	F01P050S05				5	20	
Reaction time(at 10% of If)	F01P006S05	tra	μs			0.3	RL=1kΩ, di/dt=18A/μs
	F01P015S05					0.3	RL=1kΩ, di/dt=44A/μs
	F01P025S05					0.3	RL=1kΩ, di/dt=68A/μs
	F01P050S05					0.3	RL=1kΩ, di/dt=100A/μs
Response time 1 (at 90% of If)	F01P006S05	tr	μs			0.3	RL=1kΩ, di/dt=18A/μs
	F01P015S05					0.3	RL=1kΩ, di/dt=44A/μs
	F01P025S05					0.3	RL=1kΩ, di/dt=68A/μs
	F01P050S05					0.3	RL=1kΩ, di/dt=100A/μs
Response time 2 (at 10% of If to 90% of Vo)		tr	μs			0.6	RL=1kΩ, di/dt=If/μs
Frequency bandwidth(±1dB)		BW	kHz	200			RL=1kΩ
Frequency bandwidth(±3dB)		BW	kHz	300			RL=1kΩ
Output Voltage Accuracy(Overall)	F01P006S05	X <sub>G</sub>	%			2.5	X <sub>G</sub> =(100×V <sub>oe</sub> /625)+ε <sub>G</sub> +ε <sub>L</sub>
	F01P015S05					1.9	
	F01P025S05					1.8	
	F01P050S05					1.7	

STANDARDS

EN50178, EN61010-1, EN60950-1, UL508 (file No.E243511)

※Please refer to the another sheet about conditions of UL Recognition.

Characteristic curve(TYP)

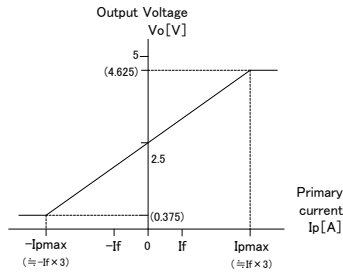

Figure 1: Linearity curve

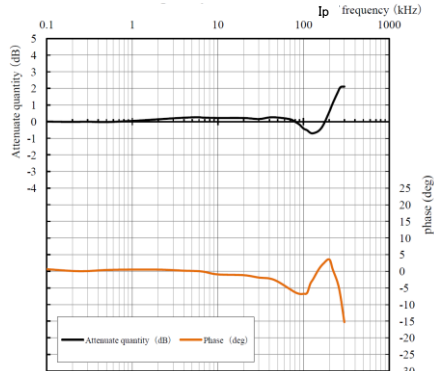

Figure 2: Frequency response curve

ex) F01P025S05  
Measurement condition Ta=+25°C, RL=1kΩ, Ip=3A, Vcc=+5V

SUPPORT DOCUMENTATION

Maximum continuous DC primary current

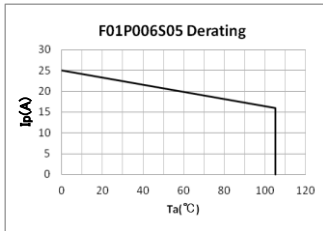

Figure 3 : Ip vs Ta for

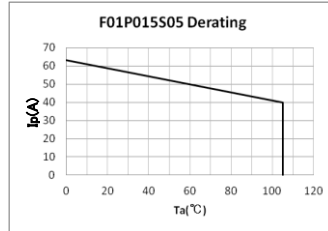

Figure 4: Ip vs Ta for F01P015S05

F01P006S05

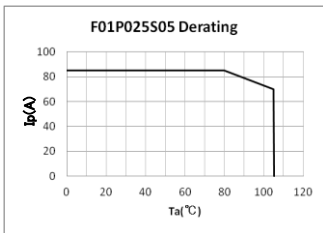

Figure 5 : Ip vs Ta for F01P025S05

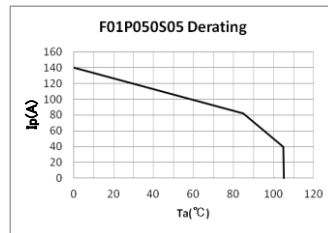

Figure 6: Ip vs Ta for F01P050S05

According to which the following conditions are true the maximum continuous DC primary current plot shows the boundary of the area.

- ①  $I_p < I_{pmax}$
- ② Junction temperature  $T_J < 125^\circ\text{C}$
- ③ Primary conductor temperature  $< 110^\circ\text{C}$
- ④ Resistor power dissipation  $< 0.5 \times \text{rated power}$

Frequency derating

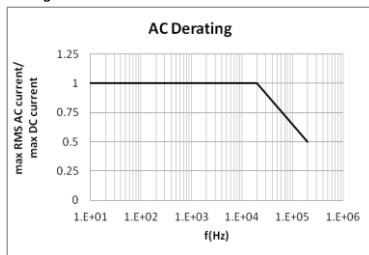
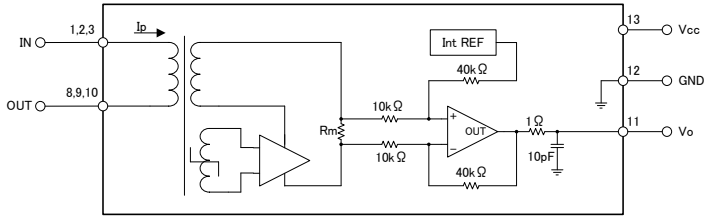

Figure 7 : Maximum RMS AC primary current/maximum DC primary current vs frequency

**CONNECTION**



If/3	
If/2	
If	

**DIMENSIONS(mm)**

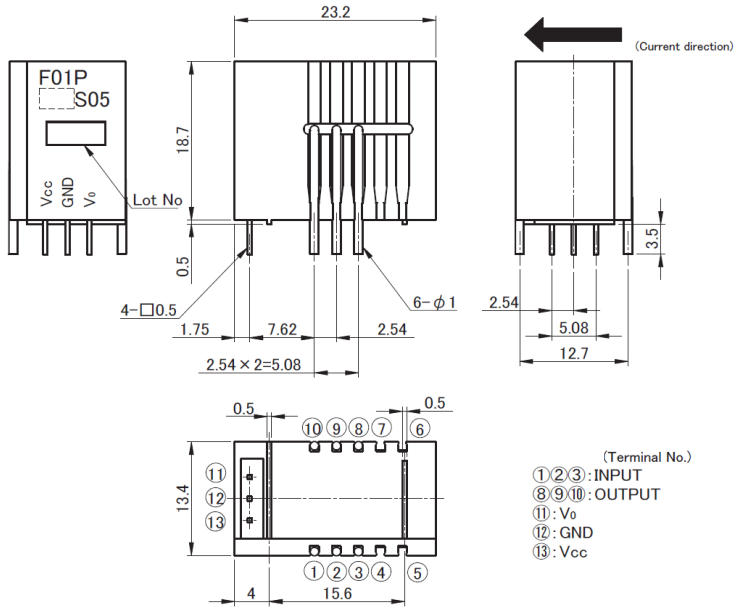

- (Terminal No.)
- ①②③: INPUT
  - ⑧⑨⑩: OUTPUT
  - ⑪: V<sub>o</sub>
  - ⑫: GND
  - ⑬: V<sub>cc</sub>

※ (Unless otherwise specified tolerances shall be ±0.5)

**RECOMMENDED HOLE DIAMETER(mm)**

